

MB995

**8th Gen. Intel[®] Core[™] i7/i5/i3
/ Xeon[®] E
ATX Motherboard**

User's Manual

Version 1.0A
(February 2020)

Copyright

© 2018 IBASE Technology, Inc. All rights reserved.

No part of this publication may be reproduced, copied, stored in a retrieval system, translated into any language or transmitted in any form or by any means, electronic, mechanical, photocopying, or otherwise, without the prior written consent of IBASE Technology, Inc. (hereinafter referred to as "IBASE").

Disclaimer

IBASE reserves the right to make changes and improvements to the products described in this document without prior notice. Every effort has been made to ensure the information in the document is correct; however, IBASE does not guarantee this document is error-free.

IBASE assumes no liability for incidental or consequential damages arising from misapplication or inability to use the product or the information contained herein, nor for any infringements of rights of third parties, which may result from its use.

Trademarks

All the trademarks, registrations and brands mentioned herein are used for identification purposes only and may be trademarks and/or registered trademarks of their respective owners.

Compliance



In a domestic environment, this product may cause radio interference in which case users may be required to take adequate measures.



This product has been tested and found to comply with the limits for a Class B device, pursuant to Part 15 of the FCC Rules. These limits are designed to provide reasonable protection against harmful interference in a residential installation. This equipment generates, uses and can radiate radio frequency energy and, if not installed and used in accordance with manufacturer's instructions, may cause harmful interference to radio communications.

WEEE



This product must not be disposed of as normal household waste, in accordance with the EU directive of for waste electrical and electronic equipment (WEEE - 2012/19/EU). Instead, it should be disposed of by returning it to a municipal recycling collection point. Check local regulations for disposal of electronic products.

Green IBASE



This product is compliant with the current RoHS restrictions and prohibits use of the following substances in concentrations exceeding 0.1% by weight (1000 ppm) except for cadmium, limited to 0.01% by weight (100 ppm).

- Lead (Pb)
- Mercury (Hg)
- Cadmium (Cd)
- Hexavalent chromium (Cr6+)
- Polybrominated biphenyls (PBB)
- Polybrominated diphenyl ether (PBDE)

Important Safety Information

Carefully read the precautions before using the board.

Environmental conditions:

- Use this product in environments with ambient temperatures between 0°C and 60°C.
- Do not leave this product in an environment where the storage temperature may be below -20° C or above 80° C. To prevent from damages, the product must be used in a controlled environment.

Care for your iBASE products:

- Before cleaning the PCB, unplug all cables and remove the battery.
- Clean the PCB with a circuit board cleaner, degreaser, or use cotton swabs and alcohol.
- Vacuum the dust with a computer vacuum cleaner to prevent the fan from being clogged.



WARNING

Attention during use:

- Do not use this product near water.
- Do not spill water or any other liquids on this product.
- Do not place heavy objects on the top of this product.

Anti-static precautions

- Wear an anti-static wrist strap to avoid electrostatic discharge.
- Place the PCB on an anti-static kit or mat.
- Hold the edges of PCB when handling.
- Touch the edges of non-metallic components of the product instead of the surface of the PCB.
- Ground yourself by touching a grounded conductor or a grounded bit of metal frequently to discharge any static.



CAUTION

Replace only with the same or equivalent type recommended by the manufacturer. Dispose of used batteries according to the manufacturer's instructions or recycle them at a local recycling facility or battery collection point.

Warranty Policy

- **IBASE standard products:**

24-month (2-year) warranty from the date of shipment. If the date of shipment cannot be ascertained, the product serial numbers can be used to determine the approximate shipping date.

- **3rd-party parts:**

12-month (1-year) warranty from delivery for the 3rd-party parts that are not manufactured by IBASE, such as CPU, CPU cooler, memory, storage devices, power adapter, panel and touchscreen.

- * PRODUCTS, HOWEVER, THAT FAIL DUE TO MISUSE, ACCIDENT, IMPROPER INSTALLATION OR UNAUTHORIZED REPAIR SHALL BE TREATED AS OUT OF WARRANTY AND CUSTOMERS SHALL BE BILLED FOR REPAIR AND SHIPPING CHARGES.

Technical Support & Services

1. Visit the IBASE website at www.ibase.com.tw to find the latest information about the product.
2. If you need any further assistance from your distributor or sales representative concerning problems that you may have encountered, please prepare the following information:
 - Product model name
 - Product serial number
 - Detailed description of the problem
 - The error messages in text or in screenshots if there is any
 - The arrangement of the peripherals
 - Software in use (such as OS and application software, including the version numbers)
3. If repair service is required, you can download the RMA form at <http://www.ibase.com.tw/english/Supports/RMAService/>. Fill out the form and contact your distributor or sales representative.

Table of Contents

Compliance	iii
Important Safety Information	iv
Warranty Policy	v
Technical Support & Services	v
Chapter 1 General Information	1
1.1 Introduction	2
1.2 Features	2
1.3 Packing List	3
1.4 Optional Accessories	3
1.5 Specifications	4
1.6 Block Diagram	6
1.7 Overview	7
1.8 Dimensions	9
Chapter 2 Hardware Configuration	11
2.1 Installations	12
2.1.1 Installing the Memory	12
2.2 Setting the Jumpers	13
2.2.1 How to Set Jumpers	13
2.3 Jumper & Connector Locations on MB995	14
2.4 Jumpers Quick Reference	15
2.4.1 Clearing CMOS Data (JP6)	15
2.4.2 PCIe (x16) Bifurcation Selection (JP2 & JP3)	16
2.5 Connectors Quick Reference	17
2.5.1 COM1 & COM2 RS-232/422/485 Ports (CN3)	18
2.5.2 Front Panel Audio Connector (J1)	19
2.5.3 Digital I/O Connector (J2)	20
2.5.4 COM3, COM4, COM5, COM6 RS-232 Ports (J8, J7, J5, J3)	21
2.5.5 PS/2 Keyboard & Mouse Ports (J10)	22
2.5.6 USB 2.0 Ports (J15)	22
2.5.7 USB 3.1 Ports (J16)	23
2.5.8 Front Panel Settings Connector (J18)	24
2.5.9 S3 Status Connector (J22)	25

2.5.10	ATX Power Connector (J23)	26
2.5.11	ATX 12V Power Connector (ATX_12V_2X1)	27
2.5.12	CPU Fan Power Connector (CPU_FAN1)	28
2.5.13	System Fan Power Connector (SYS_FAN1, SYS_FAN2)	29
Chapter 3 Drivers Installation		31
3.1	Introduction	32
3.2	Intel® Chipset Software Installation Utility	32
3.3	HD Graphics Driver Installation	33
3.4	HD Audio Driver Installation	35
3.5	LAN Driver Installation	36
3.6	Intel® Management Engine Drivers Installation	37
Chapter 4 BIOS Setup		39
4.1	Introduction	40
4.2	BIOS Setup	40
4.3	Main Settings	41
4.4	Advanced Settings	42
4.4.1	Connectivity Configuration	43
4.4.2	CPU Configuration	44
4.4.3	Power & Performance	45
4.4.4	PCH-FW Configuration	45
4.4.5	Trusted Computing	46
4.4.6	ACPI Settings	47
4.4.7	iSmart Controller	48
4.4.8	F81966 Super IO Configuration	49
4.4.9	Hardware Monitor	50
4.4.10	AMI Graphic Output Protocol Policy	50
4.4.11	USB Configuration	51
4.4.12	Network Stack Configuration	53
4.4.13	CSM Configuration	53
4.4.14	NVMe Configuration	53
4.5	Chipset Settings	54
4.5.1	System Agent (SA) Configuration	54
4.5.2	PCH-IO Configuration	56
4.6	Security Settings	57
4.7	Boot Settings	58
4.8	Save & Exit Settings	59
Appendix		61

iBASE

A.	I/O Port Address Map	62
B.	Interrupt Request Lines (IRQ).....	65
C.	Watchdog Timer Configuration	67
D.	On-Board Connector Types.....	71

Chapter 1

General Information

The information provided in this chapter includes:

- Features
- Packing List
- Specifications
- Block Diagram
- Board Overview
- Board Dimensions

1.1 Introduction

MB995 is an ATX motherboard based on the Intel® 8th Gen. Processor that features four DDR memory sockets and supports up to 64 GB and high-performance graphics processing to create media-rich content and brilliant HD entertainment with DVI-D, HDMI (2.0a) and DisplayPort display interface. Other advanced and innovative features on board include watchdog timer, Digital I/O, iAMT (11.6), TPM (2.0), vPro, and IBASE iSMART green technology.



Photo of MB995

1.2 Features

- 8th Gen. Intel® Xeon® E / Core™ i7/i5/i3 processor
- 4 x DDR4 UDIMM, expandable up to 64 GB, ECC supported per CPU SKUs
- Intel® processor integrated graphics device for DVI-D, HDMI (2.0a) and DisplayPort
- 2 x GbE LAN, 9 x USB 3.1, 6 x COM, 4 or 6 x SATA III
- 1 x PCIe (x16), 1 x PCIe (x4), 1 x PCIe (x1), 3 x PCI, 1 x Mini-PCIe, 2 x M.2 (M2280 & E2230)
- Configurable watchdog timer and digital I/O
- iAMT (11.6), TPM (2.0), vPro and iSMART

Note: vPro is supported by Intel® Xeon® E / Core™ i7/i5 processors.

1.3 Packing List

Your MB995 package should include the items listed below. If any of the items below is missing, contact the distributor or dealer from whom you purchased the product.

- MB995 Motherboard x 1
- I/O shield x 1
- SATA cable (SATA-3F) x 1
- COM port cable (PK1HK) x 1
- Disk (with chipset drivers) x 1
- This User's Manual x 1

1.4 Optional Accessories

IBASE provides optional accessories listed below. Please contact us or your dealer if you have any requirements.

- Audio cable (Audio-18K)
- USB cable (USB2K-9)
- USB 3.0 cable (USB-3K)
- PS/2 keyboard & mouse cable (PS2NK)
- Mini-PCIe extension bracket

1.5 Specifications

Product Name	MB995VF-C246	MB995VF
Form Factor	ATX motherboard	
System		
Operating System	<ul style="list-style-type: none"> • Windows 10 (64-bit) • Linux Fedora (64-bit) & Ubuntu (64-bit) • Windows Server 	
CPU	Socket LGA1151 for 8 th Gen. Intel® Xeon® E / Core™ i7/i5/i3 HC/QC/DC processors	
Chipset	Intel® C246 PCH	Intel® Q370 PCH
Memory	4 x DDR4-2666/2400 UDIMM, Max. 64GB * ECC will be supported per CPU SKUs.	
Storage	M.2 M2280 slot supporting NVMe for SSD & Mini-PCIe slot for mSATA	
Graphics	HD graphics integrated into the processor	
Network Controller	1 st LAN: Intel® I219LM GbE 2 nd LAN: Intel® I210AT GbE	1 st LAN: Intel® I219LM GbE 2 nd LAN: Intel® I211AT GbE
Super I/O	Fintek F81966D-I	
Audio	Built-in High Definition Audio controller, plus Realtek audio codec ALC888S-VD2-GR with 7.1 channels	
Power Supply	ATX Power, 12V	
Max. Power Requirement	Intel® Xeon® E-2176G 3.7 GHz with 4 x 16 GB DDR4-2400 +12V: 6.43A +5V: 1.61A +5VSB: 0.23A +3.3V: 0.67A	Intel® Core™ i7-8700 3.2 GHz with 4 x 16 GB DDR4-2400 +12V: 5.56A +5V: 1.65A +5VSB: 0.25A +3.3V: 0.65A
H/W Monitor	Yes	
Watchdog Timer	Yes (256 segments, 0, 1, 2...255 sec / min)	
BIOS	AMI BIOS	
RAID	RAID 0/1/5/10	
iSmart	Yes	
iAMT	11.6	
vPro	Yes, supported by Intel® Xeon® E / Core™ i7/i5 processors.	
TPM	2.0	

Product Name	MB995VF-C246	MB995VF
EuP/ErP Compliance	Yes	
RoHS	Yes	
Dimensions	305 x 244 mm (12" x 9.61")	
Certification	CE (EN55032:2012), FCC Class B, LVD	
I/O Ports		
Display	<ul style="list-style-type: none"> • 1 x HDMI 2.0a (4096 x 2160 at 60 Hz) • 1 x DisplayPort 1.2 (4096 x 2160 at 60 Hz) • 1 x DVI-D (1920 x 1600 at 60 Hz) 	
LAN	2 x RJ45 GbE LAN	
USB	<ul style="list-style-type: none"> • 6 x USB 3.1 (edge I/O connectors) • 3 x USB 3.1 onboard connectors: 2 ports via box-headers, 1 port via onboard vertical type connector • 2 x USB 2.0 (via onboard pin-headers) 	
Serial	6 x COM ports: <ul style="list-style-type: none"> • COM1 & COM2: RS-232/422/485 (I/O coastline connectors, jumper-less selection) • COM3 ~ COM6: RS-232 only (via on-board box-headers) 	
SATA	6 x SATA 3.0	4 x SATA 3.0
Audio Jack	1 x Line-In, 1 x Line-Out, 1 x Mic-In	
Digital IO	4-In & 4-Out	
SSD	1 slot for M.2 (M2280), 1 slot for mSATA	
Expansion Slots	<ul style="list-style-type: none"> • 1 x PCIe (x16) slot • 1 x PCIe (x4) slot • 1 x PCIe (x1) slot • 3 x PCI slot • 1 x full-size Mini-PCIe slot • 1 x M.2 M2280 slot • 1 x M.2 E2230 slot 	
Environment		
Temperature	<ul style="list-style-type: none"> • Operating: 0 ~ 60 °C (32 ~ 140 °F) • Storage: -20 ~ 80 °C (-4 ~ 176 °F) 	
Relative Humidity	0 ~ 90 %, non-condensing at 60 °C	

All specifications are subject to change without prior notice.

1.6 Block Diagram

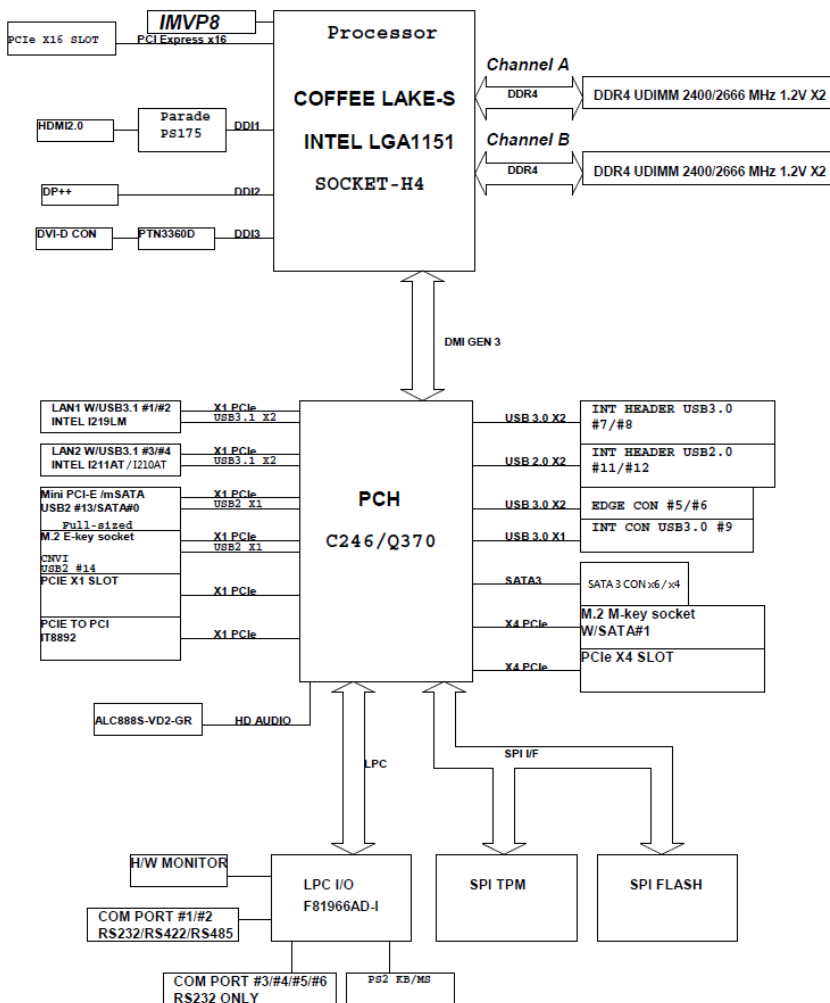

1.7 Overview

Top View

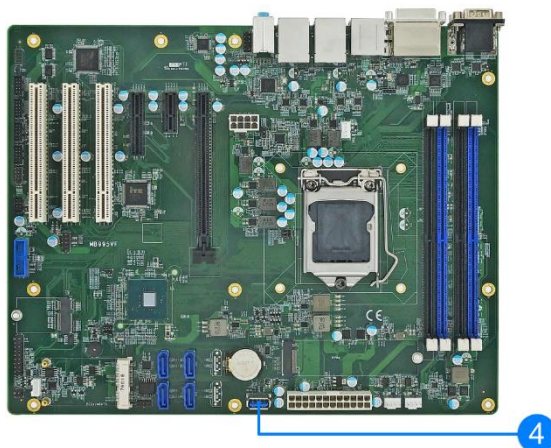

I/O View

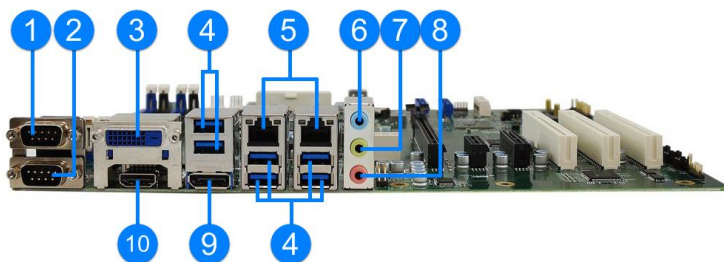

No.	Name	No.	Name
1	COM1 Port	6	Audio Line-In
2	COM2 Port	7	Audio Line-Out
3	DVI-D Port	8	Microphone-In
4	7 USB 3.1 Ports	9	DisplayPort
5	GbE LAN Ports	10	HDMI Port

Bottom View



* The photos above are for reference only. Some minor components may differ.

1.8 Dimensions

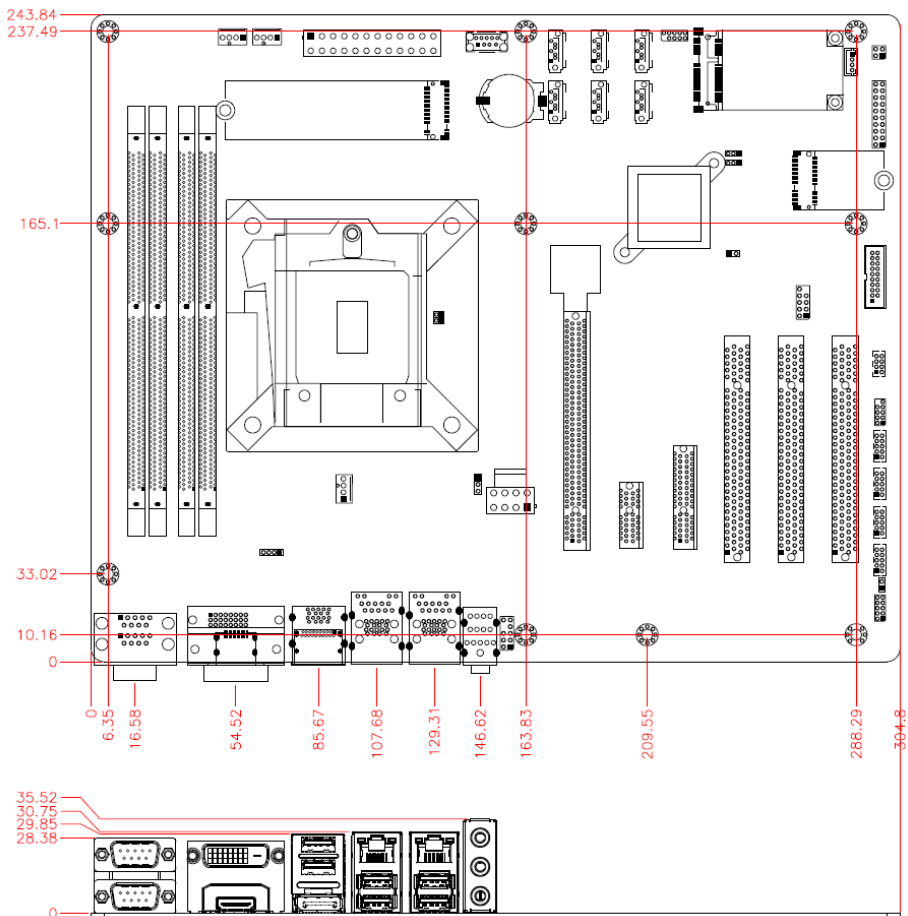

This page is intentionally left blank.

Chapter 2

Hardware Configuration

This section provides information on jumper settings and connectors on the board in order to set up a workable system. The topics covered are:

- Essential installations before you begin:
CPU and the memory
- Jumper and connector locations
- Jumper settings and information of connectors

2.1 Installations

2.1.1 Installing the Memory

To install the modules, locate the memory slot on the board and perform the following steps:

1. Press the ejector tabs of the memory slot down and outwards with your fingertips.

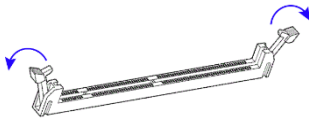

2. Hold the memory module and align the key of the module with that on the memory slot.
3. Gently push the module in an upright position until the ejector tabs of the memory slot close to hold the module in place when the module touches the bottom of the slot.

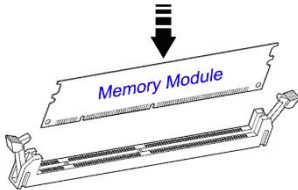

To remove the module, press the ejector tabs outwards with your fingertips to eject the module.

2.2 Setting the Jumpers

Set up and configure this board by using jumpers for various settings and features according to your needs and applications. Contact your supplier if you have doubts about the best configuration for your use.

2.2.1 How to Set Jumpers

Jumpers are short-length conductors consisting of several metal pins with a non-conductive base mounted on the circuit board. Jumper caps are used to have the functions and features enabled or disabled. If a jumper has 3 pins, you can connect either PIN1 to PIN2 or PIN2 to PIN3 by shorting.

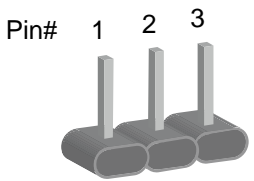

A 3-pin jumper



A jumper cap

Refer to the illustration below to set jumpers.

Pin closed	Oblique view	Illustration
Open		
1-2		
2-3		

When two pins of a jumper are encased in a jumper cap, this jumper is **closed**, i.e. turned **On**.

When a jumper cap is removed from two jumper pins, this jumper is **open**, i.e. turned **Off**.

2.3 Jumper & Connector Locations on MB995

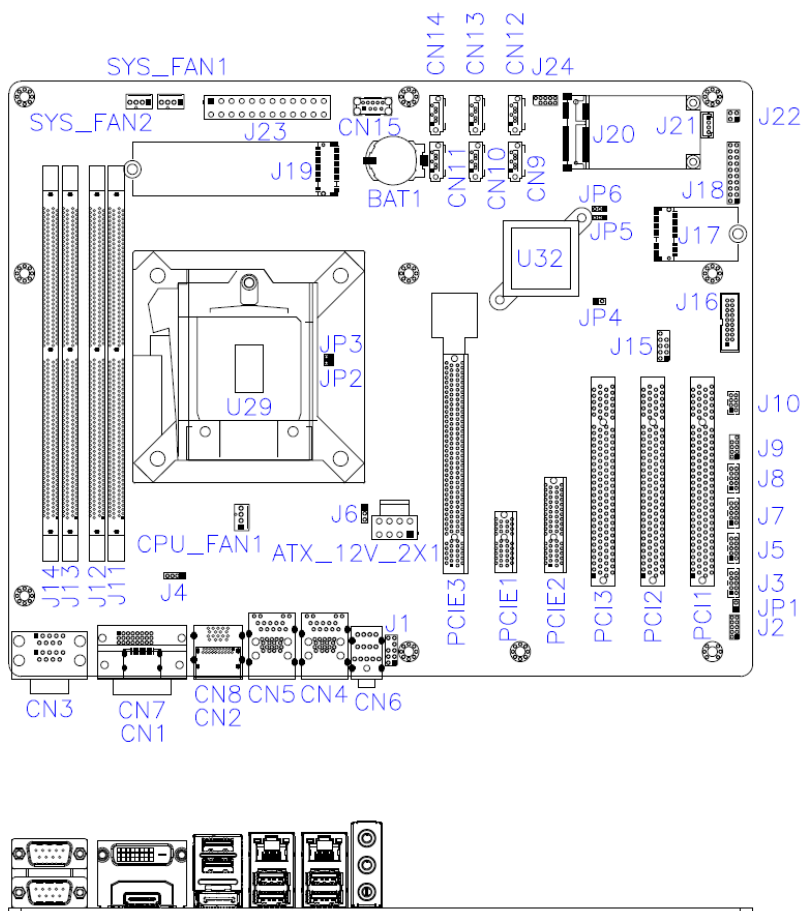

2.4 Jumpers Quick Reference

Function	Jumper Name	Page
Clearing CMOS Data	JP6	15
PCIe (x16) Bifurcation Selection	JP2, JP3	16
Factory Use Only	JP4, JP5	--



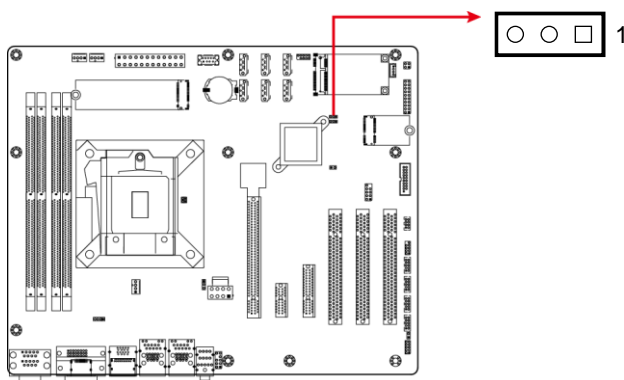



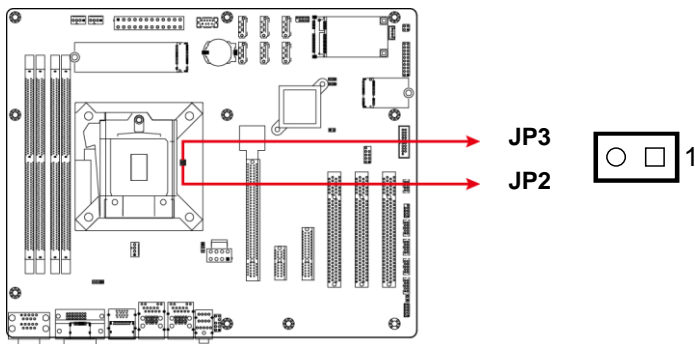

2.4.1 Clearing CMOS Data (JP6)



Function	Pin closed	Illustration
Normal (default)	1-2	1
Clear CMOS	2-3	1

2.4.2 PCIe (x16) Bifurcation Selection (JP2 & JP3)



Function	Pin closed	Illustration
1 x PCIe (x16) (default)	JP2: Open	 1
	JP3: Open	 1
2 x PCIe (x8)	JP2: Open	 1
	JP3: Close	 1
RSVD	JP2: Close	 1
	JP3: Open	 1
1 x PCIe (x8) 2 x PCIe (x4)	JP2: Close	 1
	JP3: Close	 1

2.5 Connectors Quick Reference

Function	Connector Name	Page
COM1 & COM2 RS-232/422/485 Ports	CN3	18
Front Panel Audio Connector	J1	19
Digital I/O Connector	J2	20
COM3, COM4, COM5, COM6 RS-232 Ports	J8 (COM3), J7 (COM4), J5 (COM5), J3 (COM6)	21
PS/2 Keyboard & Mouse Ports	J10	22
USB 2.0 Ports	J15	22
USB 3.1 Connectors	J16	23
Front Panel Settings Connector	J18	24
S3 Status Connector	J22	25
ATX Power Connector	J23	26
ATX 12V Power Connector	ATX_12V_2X1	27
CPU Fan Power Connector	CPU_FAN1	28
System Fan Power Connector	SYS_FAN1, SYS_FAN2	29
HDMI Port	CN1	--
DisplayPort	CN2	--
GbE LAN Port and Dual USB 3.1 Ports	CN4, CN5	--
HD Audio Jacks	CN6	--
DVI-D Port	CN7	--
USB 3.1 Port	CN8	--
USB 3.1 Vertical Port	CN15	--
SATA III Port	CN9, CN10, CN11*, CN12, CN13, CN14*	--
DDR4 UDIMM Slot	J11, J12, J13, J14	--
M.2 Slot	J17 (E2230), J19 (M2280)	--
Mini-PCIe Slot for mSATA	J20	--
Factory Use Only	J9, J24	--

* CN11 and CN14 are available for MB995VF-C246 only.

2.5.1 COM1 & COM2 RS-232/422/485 Ports (CN3)

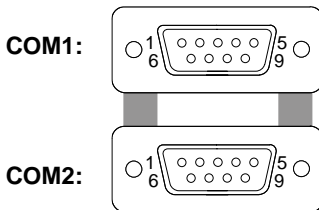
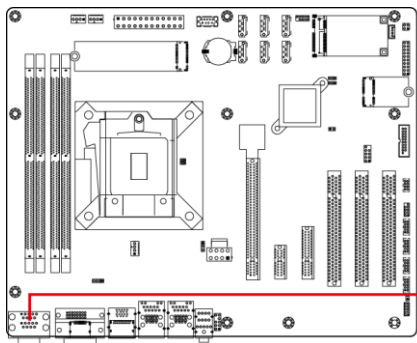

Pin	Signal Name	Pin	Signal Name
1	DCD, Data carrier detect	6	DSR, Data set ready
2	RXD, Receive data	7	RTS, Request to send
3	TXD, Transmit data	8	CTS, Clear to send
4	DTR, Data terminal ready	9	RI, Ring indicator
5	Ground		

Pin	Signal Name		
	RS-232	RS-422	RS-485
1	DCD	TX-	DATA-
2	RX	TX+	DATA+
3	TX	RX+	NC
4	DTR	RX-	NC
5	Ground	Ground	Ground
6	DSR	NC	NC
7	RTS	NC	NC
8	CTS	NC	NC
9	RI	NC	NC

2.5.2 Front Panel Audio Connector (J1)

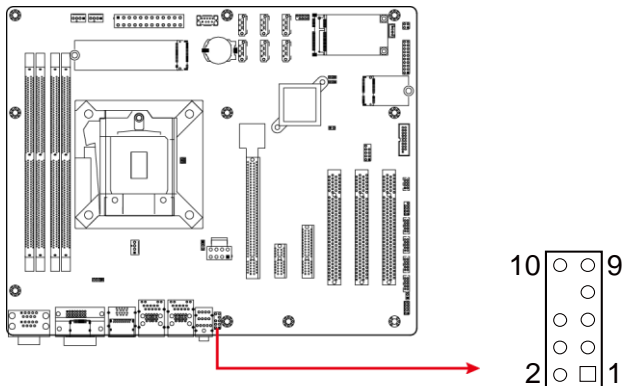

Pin	Signal Name	Pin	Signal Name
1	MIC IN_L	2	Ground
3	MIC IN_R	4	DET
5	LINE_R	6	Ground
7	Sense	8	Key
9	LINE_L	10	Ground

2.5.3 Digital I/O Connector (J2)

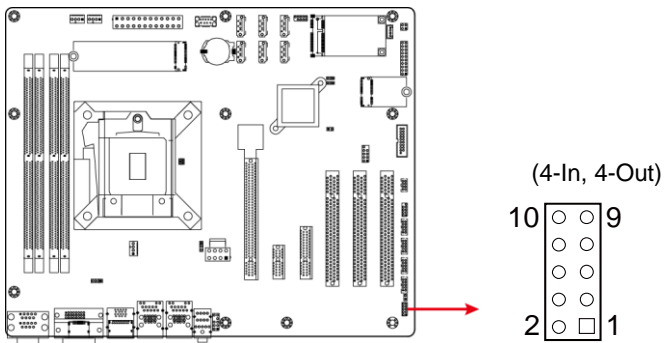

Pin	Signal Name	Pin	Signal Name
1	Ground	2	+5V
3	OUT3	4	OUT1
5	OUT2	6	OUT0
7	IN3	8	IN1
9	IN2	10	IN0

2.5.4 COM3, COM4, COM5, COM6 RS-232 Ports (J8, J7, J5, J3)

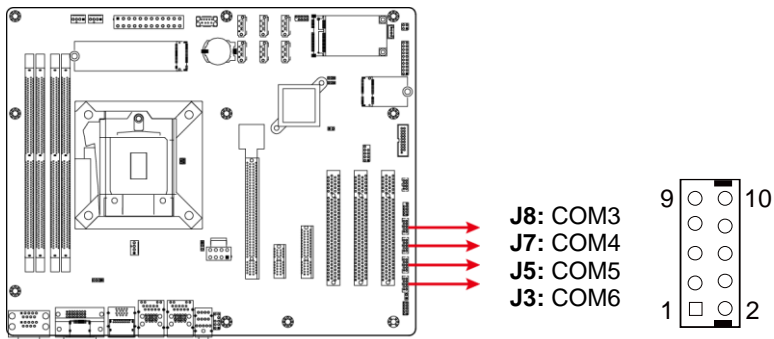

Pin	Signal Name	Pin	Signal Name
1	DCD, Data carrier detect	2	RXD, Receive data
3	TXD, Transmit data	4	DTR, Data terminal ready
5	Ground	6	DSR, Data set ready
7	RTS, Request to send	8	CTS, Clear to send
9	RI, Ring indicator	10	Key

2.5.5 PS/2 Keyboard & Mouse Ports (J10)

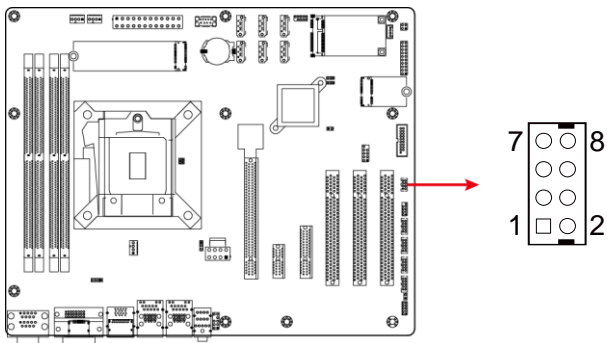

Pin	Signal Name	Pin	Signal Name
1	VCC	2	VCC
3	MDA	4	KBDA
5	MCL	6	KBCL
7	Ground	8	Ground

2.5.6 USB 2.0 Ports (J15)

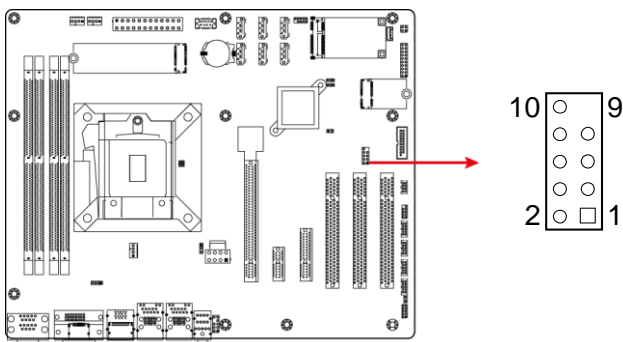

Pin	Signal Name	Pin	Signal Name
1	VCC	2	VCC
3	D0-	4	D1-
5	D0+	6	D1+
7	Ground	8	Ground
9	KEY	10	NC

2.5.7 USB 3.1 Ports (J16)

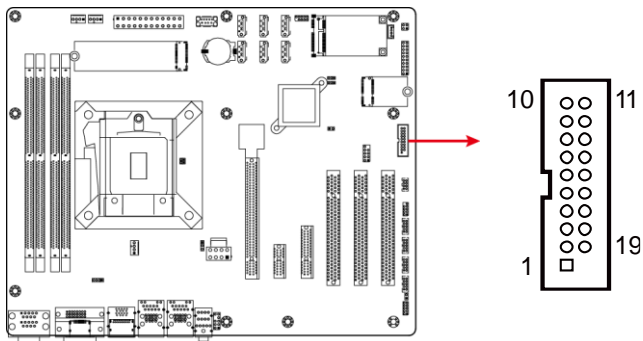

Pin	Signal Name	Pin	Signal Name
1	VCC	11	P2_U2_D+
2	P1_SSRX-	12	P2_U2_D-
3	P1_SSRX+	13	Ground
4	Ground	14	P2_SSTX+
5	P1_SSTX-	15	P2_SSTX-
6	P1_SSTX+	16	Ground
7	Ground	17	P2_SSRX+
8	P1_U2_D-	18	P2_SSRX-
9	P1_U2_D+	19	VCC
10	NC		

2.5.8 Front Panel Settings Connector (J18)

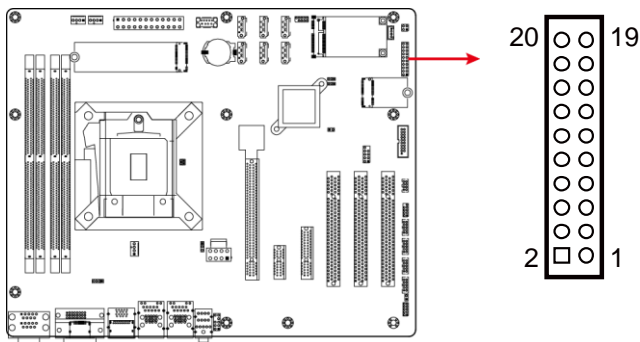

Pin	Signal Name	Pin	Signal Name
1	Power LED+	2	SPK
3	Ground	4	NC
5	Power LED-	6	Ground
7	NC	8	SPK (VCC)
9	Ground	10	NC
11	Ground	12	NC
13	Power BTN	14	Power BTN
15	NC	16	NC
17	Reset BTN	18	Reset BTN
19	HDD LED+	20	HDD LED-

J18 is utilized for system indicators to provide light indication of the computer activities and switches to change the computer status. It provides interfaces for the following functions.

- **ATX Power ON Switch (Pins 13 and 14)**

The 2 pins make an “ATX Power Supply On/Off Switch” for the system that connects to the power switch on the case. When pressed, the power switch will force the system to power on. When pressed again, it will power off the system.

- **Hard Disk Drive LED Connector (Pins 19 and 20)**

This connector connects to the hard drive activity LED on control panel. This LED will flash when the HDD is being accessed.

- Reset Switch (Pins 17 and 18)**

The reset switch allows you to reset the system without turning the main power switch off and then on again. Orientation is not required when making a connection to this header.
- Power LED (Pins 1 and 5)**

This connector connects to the system power LED on control panel. This LED will light when the system turns on.
- Speaker Connector (Pins 2 and 8)**

Connect the two pins for setting up the system output speaker.

2.5.9 S3 Status Connector (J22)

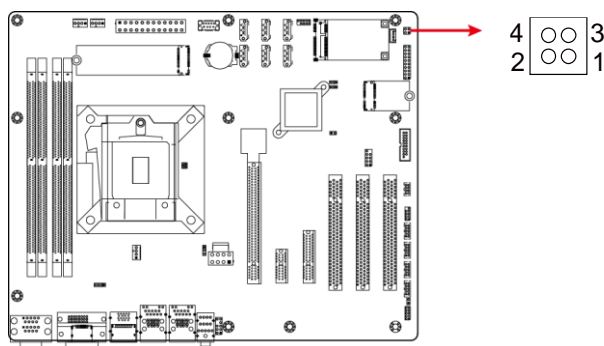

Pin	Signal Name	Pin	Signal Name
1	3VDUAL	2	Ground
3	VCC3	4	Ground

2.5.10 ATX Power Connector (J23)

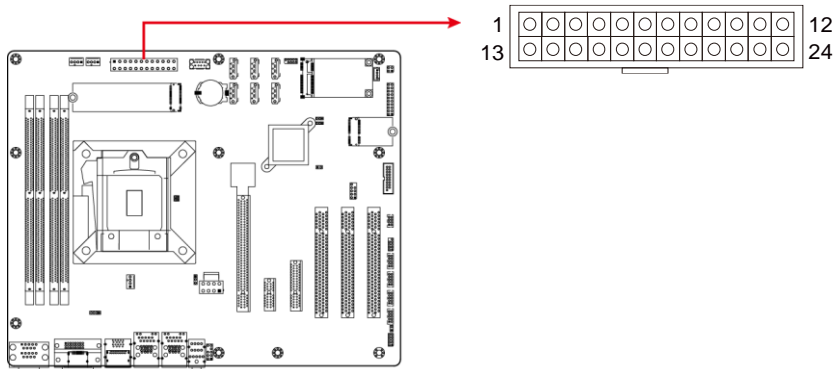

Pin	Signal Name	Pin	Signal Name
1	3.3V	13	3.3V
2	3.3V	14	-12V
3	Ground	15	Ground
4	+5V	16	PS-ON
5	Ground	17	Ground
6	+5V	18	Ground
7	Ground	19	Ground
8	Power good	20	-5V
9	5VSB	21	+5V
10	+12V	22	+5V
11	+12V	23	+5V
12	3.3V	24	Ground

2.5.11 ATX 12V Power Connector (ATX_12V_2X1)

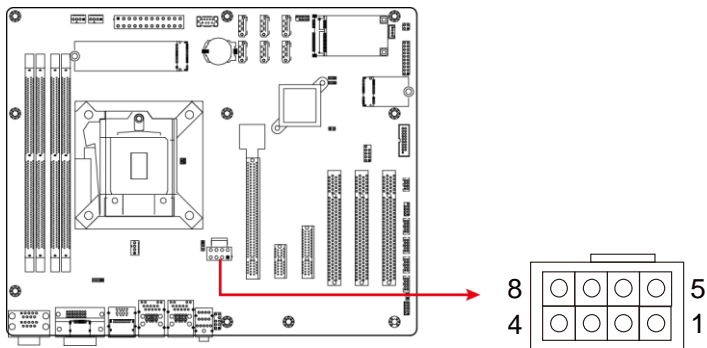

Pin	Signal Name	Pin	Signal Name
1	Ground	5	+12V
2	Ground	6	+12V
3	Ground	7	+12V
4	Ground	8	+12V

2.5.12 CPU Fan Power Connector (CPU_FAN1)

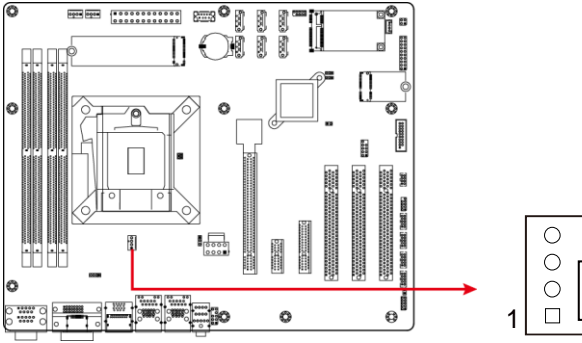

Pin	Signal Name	Pin	Signal Name
1	Ground	3	Rotation detection
2	+12V	4	Control

2.5.13 System Fan Power Connector (SYS_FAN1, SYS_FAN2)

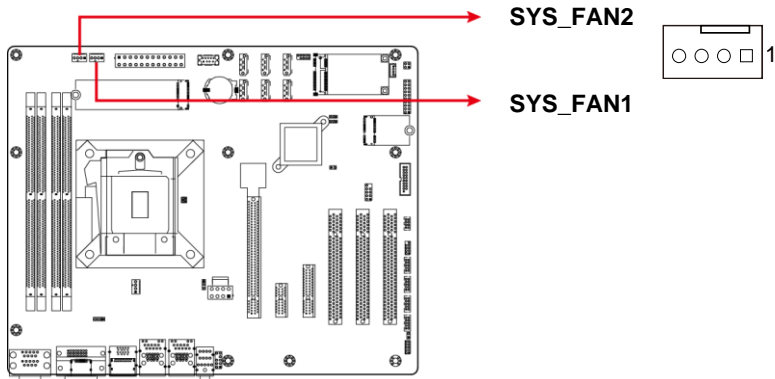

Pin	Signal Name	Pin	Signal Name
1	Ground	3	Rotation detection
2	+12V	4	Control

This page is intentionally left blank.

Chapter 3

Drivers Installation

This chapter introduces installation of the following drivers:

- Intel® Chipset Software Installation Utility
- HD Graphics Driver
- HD Audio Driver
- LAN Driver
- Intel® Management Engine Drivers Installation

3.1 Introduction

This section describes the installation procedures for software and drivers. The software and drivers are included with the motherboard. If you find anything missing, please contact the distributor where you made the purchase. The contents of this section include the following:

Note: After installing your operating system, you must install the Intel® Chipset Software Installation Utility first before proceeding with the drivers installation.

3.2 Intel® Chipset Software Installation Utility

The Intel® Chipset drivers should be installed first before the software drivers to install INF files for Plug & Play function for Intel chipset components. Follow the instructions below to complete the installation.

1. Insert the disk enclosed in the package with the board. Click **Intel** on the left pane and then **Intel(R) Coffeelake Chipset Drivers** on the right pane.



2. Click **Intel(R) Chipset Software Installation Utility**.

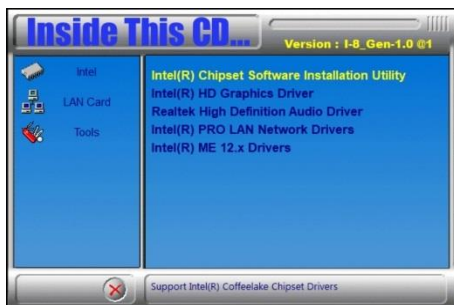

3. When the *Welcome* screen to the Intel® Chipset Device Software appears, click **Next** to continue.
4. Accept the software license agreement and proceed with the installation process.
5. On the *Readme File Information* screen, click **Install** for installation.
6. The driver has been completely installed. Restart the computer for changes to take effect.

3.3 HD Graphics Driver Installation

1. Click **Intel** on the left pane and then **Intel(R) Coffeelake Chipset Drivers** on the right pane.

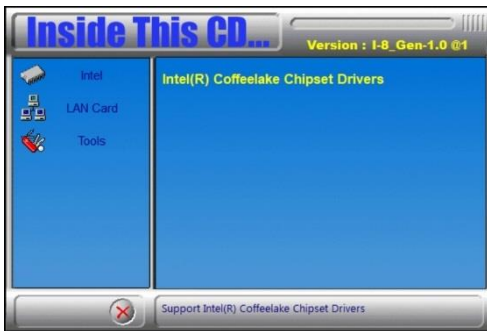

2. Click **Intel(R) HD Graphics Driver**.

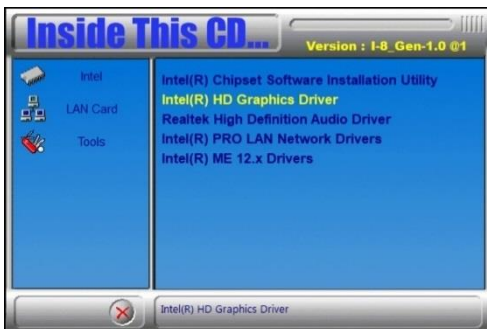

3. When the *Welcome* screen appears, click **Next** to continue.

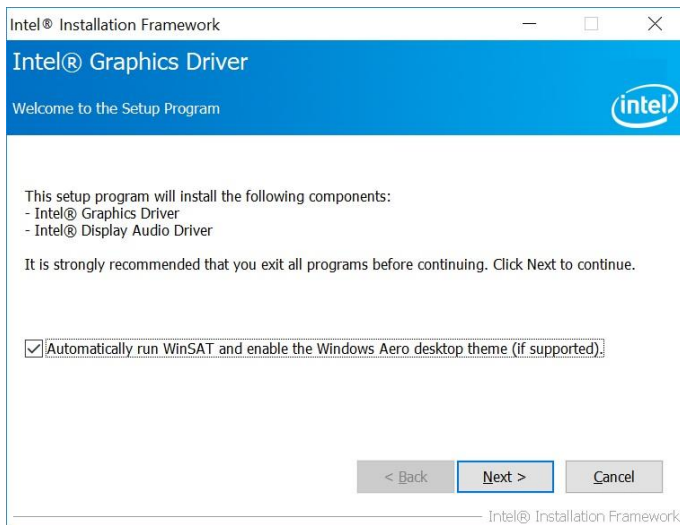

4. Accept the license agreement and click **Next**.
5. On the *Readme File Information* screen, click **Next** until the installation starts.
6. The driver has been completely installed. Restart the computer for changes to take effect.

3.4 HD Audio Driver Installation

1. Click **Intel** on the left pane and then **Intel(R) Coffeelake Chipset Drivers** on the right pane.



2. Click **Realtek High Definition Audio Driver**.

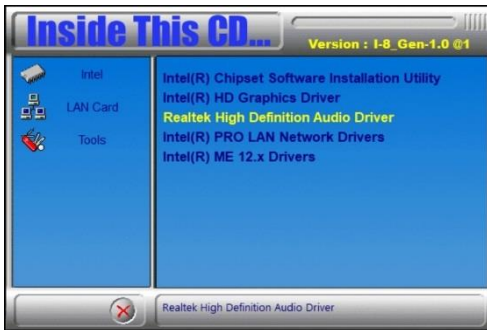

3. On the *Welcome* screen of the InstallShield Wizard, click **Next**.
4. Click **Next** until the installation starts.
5. The driver has been completely installed. Restart the computer for changes to take effect.

3.5 LAN Driver Installation

1. Click **Intel** on the left pane and then **Intel(R) Coffeelake Chipset Drivers** on the right pane.

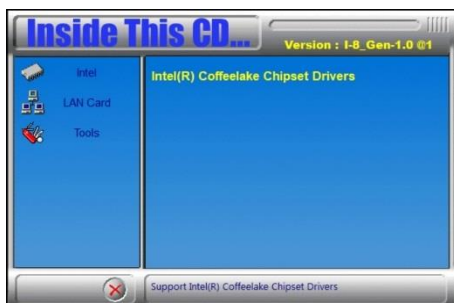

2. Click **Intel(R) PRO LAN Network Drivers**.

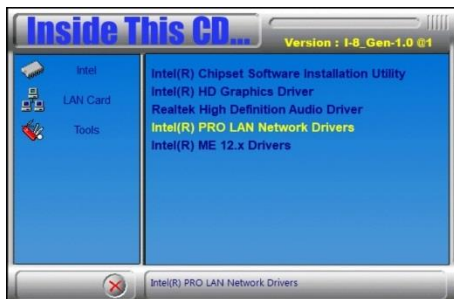

3. When the *Welcome* screen appears, click **Next**.

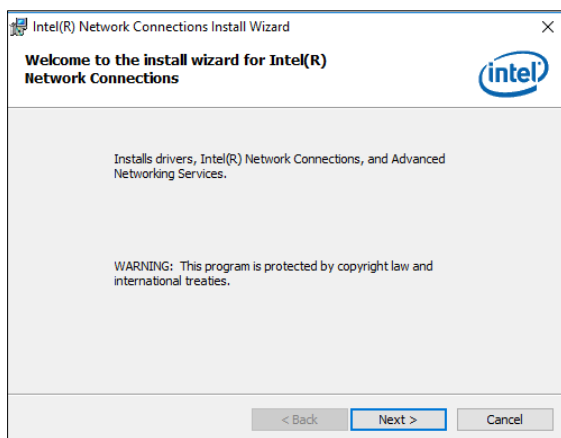

4. Accept the license agreement and click **Next**.
5. On the *Setup Options* screen, click the checkbox to select the desired driver(s) for installation. Then click **Next** to continue.

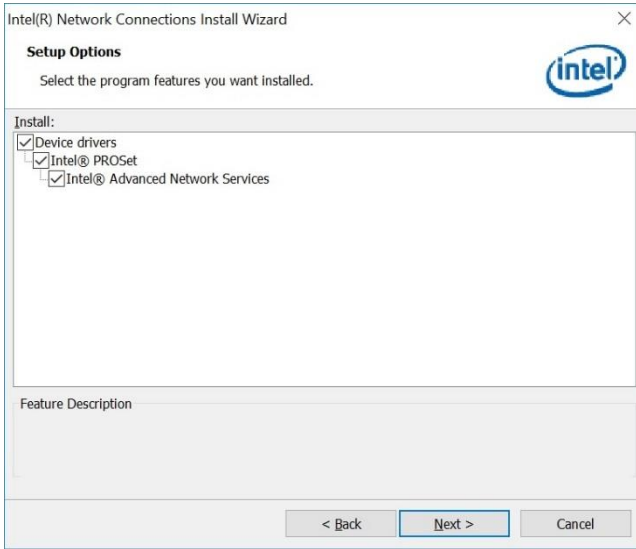

6. The wizard is ready for installation. Click **Install**.
7. As the installation is complete, restart the computer for changes to take effect.

3.6 Intel® Management Engine Drivers Installation

1. Click **Intel** on the left pane and then **Intel(R) Coffeelake Chipset Drivers** on the right pane.

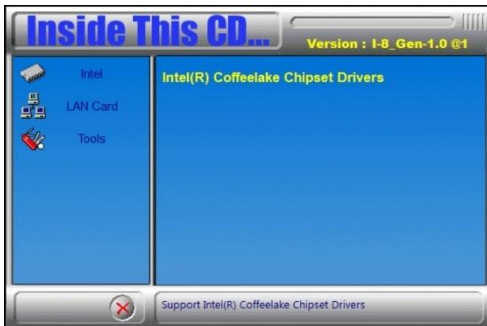

2. Click **Intel(R) ME 12.x Drivers**.



3. When the *Welcome* screen appears, click **Next**.

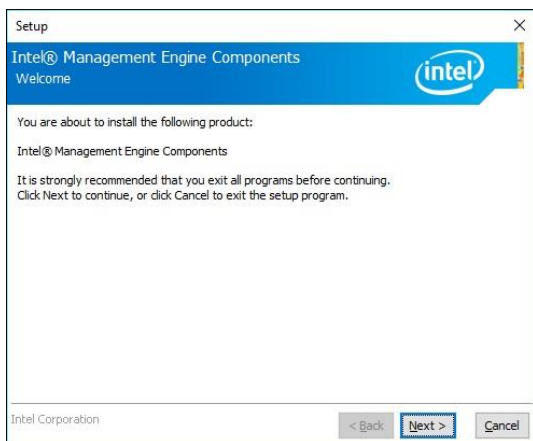

4. Accept the license agreement, choose a destination folder and click **Next** until the installation starts.
5. As the driver has been successfully installed, restart the computer for changes to take effect.

Chapter 4

BIOS Setup

This chapter describes the different settings available in the AMI BIOS that comes with the board. The topics covered in this chapter are as follows:

- Main Settings
- Advanced Settings
- Chipset Settings
- Boot Settings
- Security Settings
- Save & Exit

4.1 Introduction

The BIOS (Basic Input/Output System) installed in the ROM of your computer system supports Intel® processors. The BIOS provides critical low-level support for standard devices such as disk drives, serial ports and parallel ports. It also provides password protection as well as special support for detailed fine-tuning of the chipset controlling the entire system.

4.2 BIOS Setup

The BIOS provides a Setup utility program for specifying the system configurations and settings. The BIOS ROM of the system stores the Setup utility. When you turn on the computer, the BIOS is immediately activated. Press the key immediately allows you to enter the Setup utility. If you are a little bit late pressing the key, POST (Power On Self Test) will continue with its test routines, thus preventing you from invoking the Setup.

If you still need to enter Setup, restart the system by pressing the "Reset" button or simultaneously pressing the <Ctrl>, <Alt> and <Delete> keys. You can also restart by turning the system Off and back On again.

The following message will appear on the screen:

```
Press <DEL> to Enter Setup
```

In general, press the arrow keys to highlight items, <Enter> to select, the <PgUp> and <PgDn> keys to change entries, <F1> for help, and <Esc> to quit.

When you enter the BIOS Setup utility, the *Main Menu* screen will appear on the screen. The Main Menu allows you to select from various setup functions and exit choices.

Warning: It is strongly recommended that you avoid making any changes to the chipset defaults.

These defaults have been carefully chosen by both AMI and your system manufacturer to provide the absolute maximum performance and reliability. Changing the defaults could make the system unstable and crash in some cases.

4.3 Main Settings

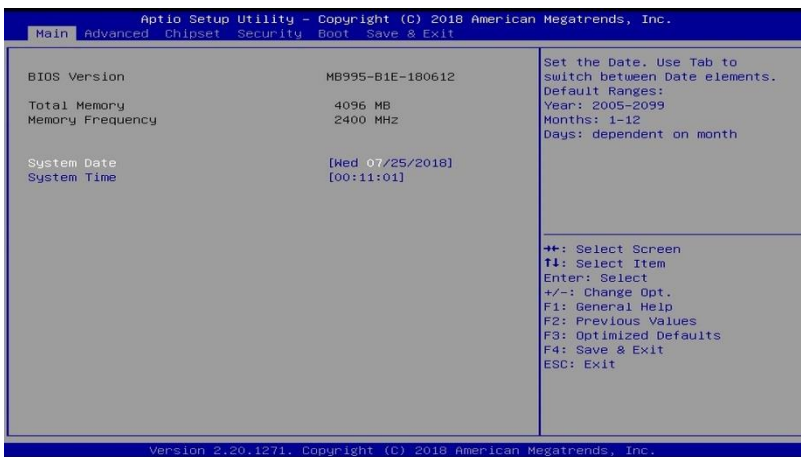

BIOS Setting	Description
System Date	<p>Sets the date. Use the Tab to switch between the data elements.</p> <p>Default Ranges: Year: 2005-2099 Months: 1-12 Days: dependent on month</p>
System Time	<p>Set the time. Use Tab to switch between the Time elements.</p>

4.4 Advanced Settings

This section allows you to configure, improve your system and allows you to set up some system features according to your preference.

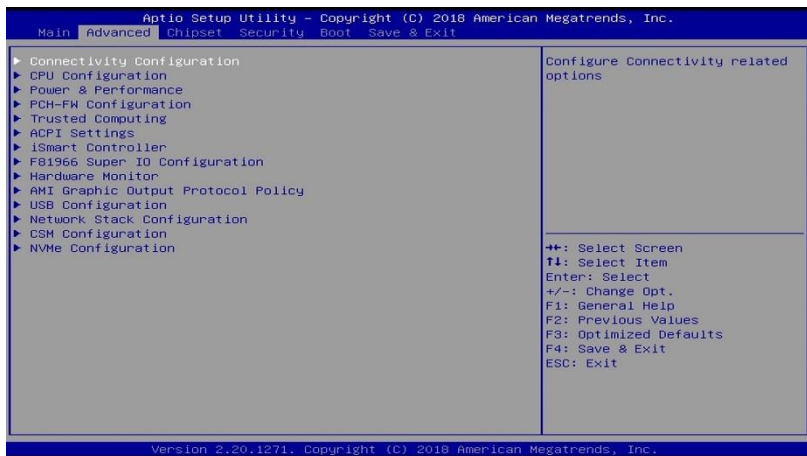

BIOS Setting	Description
Connectivity Configuration	Configure Connectivity related options
CPU Configuration	Displays CPU configuration parameters
Power & Performance	Power & Performance Options
PCH-FW Configuration	Configures management engine technology parameters
Trusted Computing*	Trusted computing settings.
ACPI Settings	Displays system ACPI parameters.
iSmart Controller	Sets up the power on time for the system.
F81966 Super IO Configuration	Displays super IO chip parameters.
Hardware Monitor	Shows super IO monitor hardware status.
AMT Graphic Output Protocol Policy	User Select Monitor Output by Graphic Output Protocol
USB Configuration	Displays USB configuration parameters.
Network Stack Configuration	Network Stack Settings
CSM Configuration	Enables / Disables option ROM execution settings, etc.
NVMe Configuration	NVMe Device Options Settings

4.4.1 Connectivity Configuration



BIOS Setting	Description
CNVi Mode	This option configures Connectivity. [Auto Detection] means that if discrete solution is discovered it will be enabled by default. Otherwise, integrated solution (CNVi) will be enabled; [Disable Integrated] disables Integrated Solution.
MfUart1 type	This is a test option which allows configuration of UART type for WiFi side band communication.
CoExistence Manager	CoEx Manager mitigates radio coexistence issues between Intel WWAN (modem) and Intel WLAN (WiFi/BT). This should be enabled only if both WWAN and WLAN solutions are based on Intel components.
WWAN Enable	Enables/Disables M.w WWAN module. WWAN can only be enabled for re-work board.
Discrete Bluetooth Module	Seriallo UART0 needs to be enabled to select BT module.
Advanced Settings	Configure ACPI objects for wireless devices

4.4.2 CPU Configuration

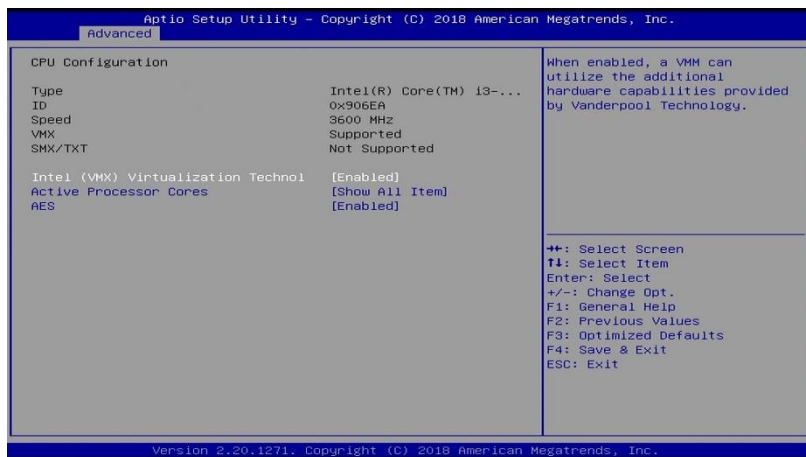

BIOS Setting	Description
Intel (VMX) Virtualization Technology	When enabled, a VMM can utilize the additional hardware capabilities provided by Vanderpool Technology.
Active Processor Cores	Number of cores to enable in each processor package. Options: All, 1, 2, 3
AES	Enables / Disables AES (Advanced Encryption Standard).

4.4.3 Power & Performance



BIOS Setting	Description
CPU – Power Management Control	CPU – Power Management Control Options
Intel SpeedStep	Allows more than two frequency ranges to be supported
Intel Speed Shift Technology	This can be Enabled or Disabled.

4.4.4 PCH-FW Configuration

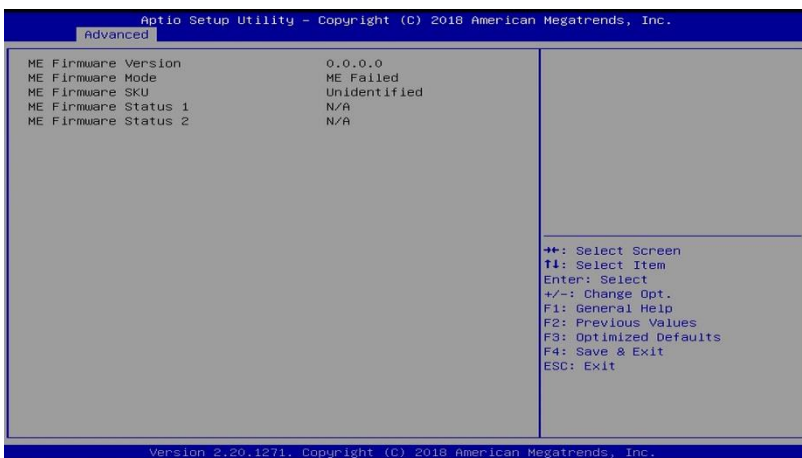

4.4.5 Trusted Computing



BIOS Setting	Description
Security Device Support	Enables / Disables BIOS support for security device. OS will not show security device. TCG EFI protocol and INTIA interface will not be available.
SHA-1 PCR Bank	Enable or Disable SHA-1 PCR Bank
SHA256 PCR Bank	Enable or Disable SHA256 PCR Bank
Pending operation	Schedule an operation for the security device. NOTE: Your computer will reboot during restart in order to change state of security device.
Platform Hierarchy	Enable or Disable Platform Hierarchy
Storage Hierarchy	Enable or Disable Storage Hierarchy
Endorsement Hierarchy	Enable or Disable Endorsement Hierarchy
TPM2.0 UEFI Spec Version	Select the TCG2 Spec version support: TCG_1_2: the compatible mode for Win8/Win10 TCG_2: Support new TCG2 protocol and even format for Win10 or later.
Physical Presence Spec Version	Select to tell OS to support PPI Spec Version 1.2 or 1.3. Note some HCK tests might not support 1.3.
Device Select	TPM 1.2 will restrict support to TPM 1.2 devices. TPM 2.0 will restrict to support TPM 2.0 devices. Auto will support both, with the default set to TPM 2.0 devices. If not found, TPM 1.2 devices will be enumerated.

4.4.6 ACPI Settings

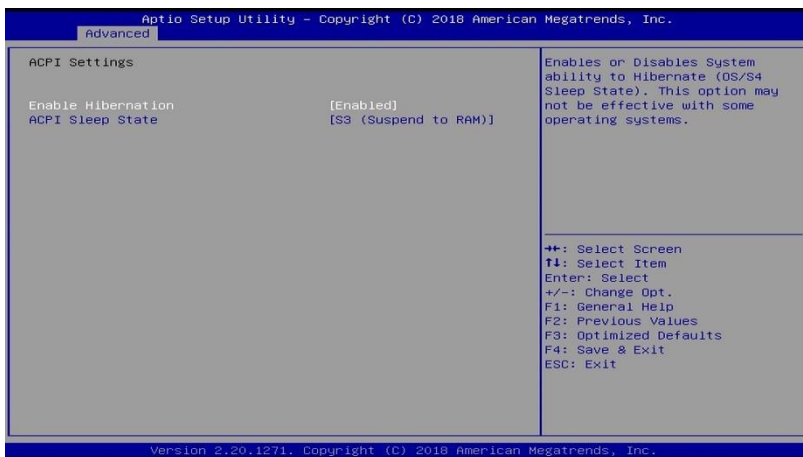

BIOS Setting	Description
Enable Hibernation	Enables / Disables the system ability to hibernate (OS/S4 Sleep State). This option may be not effective with some OS.
ACPI Sleep State	Selects an ACPI sleep state where the system will enter when the Suspend button is pressed. Options: Suspend Disabled, S3 (Suspend to RAM)

4.4.7 iSmart Controller

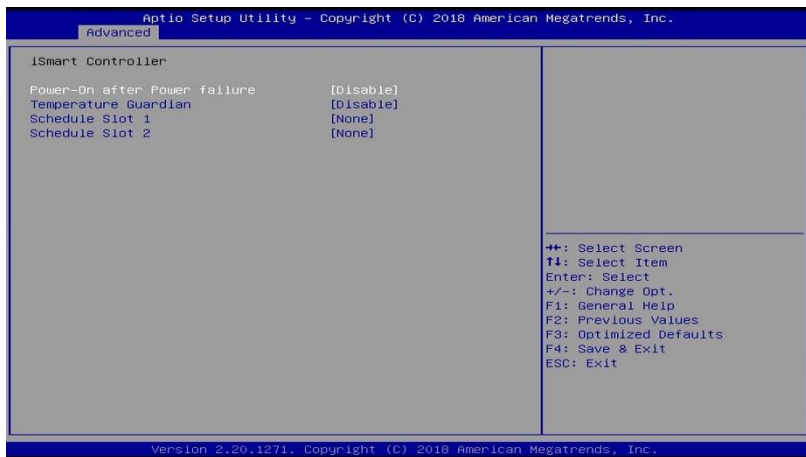

BIOS Setting	Description
Power-On after Power Failure	Enables / Disables the system to be turned on automatically after a power failure.
Temperature Guardian	Generate the reset signal when system hands up on POST.
Schedule Slots	<p>Sets up the hour / minute / day for the power-on schedule for the system.</p> <p>Options:</p> <ul style="list-style-type: none"> • None • Power On • Power On / Off <p>Important: If you would like to set up a schedule between adjacent days, configure two schedule slots.</p> <p>For example, if setting up a schedule from Wednesday 5 p.m. to Thursday 2 a.m., configure two schedule slots. But if setting up a schedule from 3 p.m to 5 p.m. on Wednesday, configure only a schedule slot.</p>

4.4.8 F81966 Super IO Configuration

Aptio Setup Utility - Copyright (C) 2018 American Megatrends, Inc.		
Advanced		
F81966 Super IO Configuration	F81966	Set Parameters of Serial Port 1 (COMA)
<ul style="list-style-type: none"> Super IO Chip ▶ Serial Port 1 Configuration ▶ Serial Port 2 Configuration ▶ Serial Port 3 Configuration ▶ Serial Port 4 Configuration ▶ Serial Port 5 Configuration ▶ Serial Port 6 Configuration 		
Serial Port 1 Configuration		Enable or Disable Serial Port (COM)
Serial Port	[Enabled]	
Device Settings	I0=3F8h; IRQ=4;	
Change Settings	[Auto]	
SERIAL PORT MODE SELECT	[RS232 Mode]	
Serial Port 2 Configuration		Enable or Disable Serial Port (COM)
Serial Port	[Enabled]	
Device Settings	I0=2F8h; IRQ=3;	
Change Settings	[Auto]	
SERIAL PORT MODE SELECT	[RS232 Mode]	
Serial Port 3 Configuration		Enable or Disable Serial Port (COM)
Serial Port	[Enabled]	
Device Settings	I0=3E8h; IRQ=5;	
Change Settings	[Auto]	
Serial Port 4 Configuration		Enable or Disable Serial Port (COM)
Serial Port	[Enabled]	
Device Settings	I0=2E8h; IRQ=6;	
Change Settings	[Auto]	
Serial Port 5 Configuration		Enable or Disable Serial Port (COM)
Serial Port	[Enabled]	
Device Settings	I0=2F0h; IRQ=7;	
Change Settings	[Auto]	
Serial Port 6 Configuration		Enable or Disable Serial Port (COM)
Serial Port	[Enabled]	
Device Settings	I0=2E0h; IRQ=10;	
Change Settings	[Auto]	

BIOS Setting	Description
Serial Port Configuration	<p>Sets parameters of Serial Ports.</p> <p>Enables / Disables the serial port and select an optimal setting for the Super IO device.</p>

4.4.9 Hardware Monitor

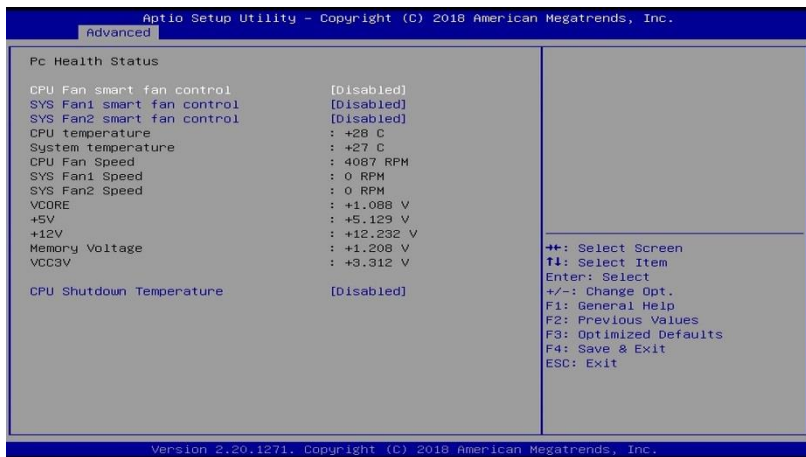

BIOS Setting	Description
CPU Smart Fan Control	Enables / Disables the CPU smart fan feature. Options: Disabled / 50 °C / 60 °C / 70 °C / 80 °C
System Smart Fan Control	Enables / Disables the system smart fan feature. Options: Disabled / 50 °C / 60 °C / 70 °C / 80 °C
Temperatures / Voltages	These fields are the parameters of the hardware monitoring function feature of the motherboard. The values are read-only values as monitored by the system and show the PC health status.
CPU Shutdown Temperature	Options: Disabled / 70 °C / 75 °C / 80 °C / 85 °C / 90 °C / 95 °C

4.4.10 AMI Graphic Output Protocol Policy



BIOS Setting	Description
Output Select	Selects the display output interface

4.4.11 USB Configuration

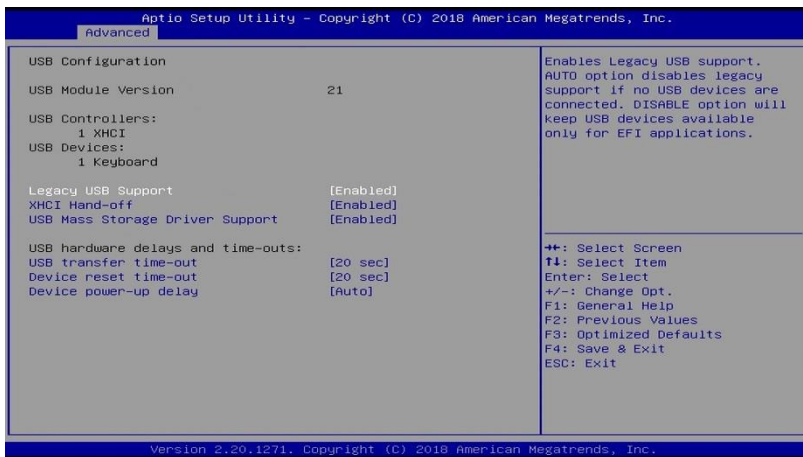

BIOS Setting	Description
Legacy USB Support	Enables Legacy USB support. <ul style="list-style-type: none"> • Auto disables legacy support if there is no USB device connected. • Disable keeps USB devices available only for EFI applications.
XHCI Hand-off	This is a workaround for OSeS without XHCI hand-off support. The XHCI ownership change should be claimed by XHCI driver.
USB Mass Storage Driver Support	Enables / Disables the support for USB mass storage driver.
Port 60/64 Emulation	Enables / Disables I/O port 60h/64h emulation support. This should be enabled for the complete USB keyboard legacy support for non-USB aware OSeS.
USB Transfer time-out	The time-out value for control, bulk, and Interrupt transfers. Options: 1 sec / 5 sec / 10 sec / 20 sec
Device reset time-out	Seconds of delaying execution of start unit command to USB mass storage device. Options: 10 sec / 20 sec / 30 sec / 40 sec

BIOS Setting	Description
Device power-up delay	<p>The maximum time the device will take before it properly reports itself to the Host Controller.</p> <p>Auto uses default value for a Root port it is 100ms. But for a Hub port, the delay is taken from Hub descriptor.</p> <p>Options: Auto / Manual</p>
Mass Storage Devices	<p>Mass storage device emulation type. 'Auto' enumerates devices according to their media format. Optical deives are emulated as 'CDROM'. Drives with no media will be emulated according to a drive type.</p>

4.4.12 Network Stack Configuration

Aptio Setup Utility - Copyright (C) 2018 American Megatrends, Inc.		
Advanced		
Network Stack	[Disabled]	Enable/Disable UEFI Network Stack

BIOS Setting	Description
Network Stack	Enable/Disable UEFI Network Stack.

4.4.13 CSM Configuration

Aptio Setup Utility - Copyright (C) 2018 American Megatrends, Inc.		
Advanced		
Compatibility Support Module Configuration		Enable/Disable CSM Support.
CSM Support	[Enabled]	
Option ROM execution		
Network	[Do not launch]	

BIOS Setting	Description
CSM Support	Enables / Disables CSM support.
Network	Controls the execution of UEFI and Legacy PXE OpROM. Options: Do not launch / Legacy

4.4.14 NVMe Configuration

Aptio Setup Utility - Copyright (C) 2018 American Megatrends, Inc.		
Advanced		
NVMe Configuration		
No NVMe Device Found		

BIOS Setting	Description
NVMe Configuration	NVMe controller and drive information.

4.5 Chipset Settings

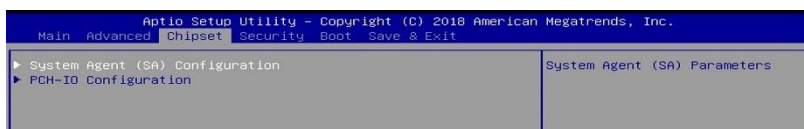

BIOS Setting	Description
System Agent (SA) Configuration	System Agent (SA) parameters
PCH-IO Configuration	PCH parameters

4.5.1 System Agent (SA) Configuration



BIOS Setting	Description
Graphics Configuration	Configures the graphics settings.
VT-d	Checks if VT-d function on MCH is supported.

4.5.1.1. Graphics Configuration



BIOS Setting	Description
Graphics Turbo IMON Current	Graphics turbo IMON current values supported (14-31)
Skip Scanning of External Gfx Card	If enabled, it will not scan for external Gfx Card on PEG and PCH PCIE ports.
Primary Display	The default setting is Auto.
External Gfx Card Primary Display Configuration	Configures the external Gfx card primary display. <ul style="list-style-type: none"> Primary PEG: Selects the primary PEG (options: Auto / PEG11 / PEG12). Primary PCIE: Selects the primary PCIE (options: Auto / PCIE1 ~ PCIE18)
Internal Graphics	Keep IGFX enabled based on the setup options. Options: Auto / Disabled / Enabled
GTT Size	Sets the GTT size as 2 MB, 4 MB, or 8 MB.
Aperture Size	Sets the aperture size as 128 MB / 256 MB / 512 MB / 1024 MB / 2048 MB. Note: Above 4 GB MMIO BIOS assignment is automatically enabled when selecting 2048 MB aperture. To use this feature, disable CSM support.
DVMT Pre-Allocated	Sets DVMT 5.0 pre-allocated (fixed) graphics memory size used by the internal graphics device. Options: 0M / 32M / 64M / 4M / 8M / 12M / 16M / 20M / 24M / 28M / 32M/F7 / 36M / 40M / 44M / 48M / 52M / 56M / 60M
DVMT Total Gfx Mem	Selects DVMT 5.0 total graphic memory size used by the internal graphics device. Options: 256M / 128M / MAX

4.5.2 PCH-IO Configuration



BIOS Setting	Description
SATA and RST Configuration	Configures SATA devices.
PCH LAN Controller	Enables / Disables the onboard NIC.
Wake on LAN Enable	Enables / Disables the integrated LAN to wake up the system.

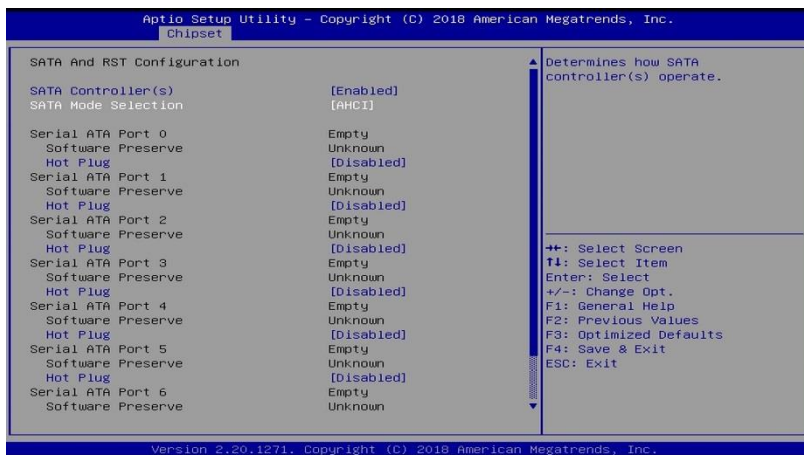

4.6 Security Settings

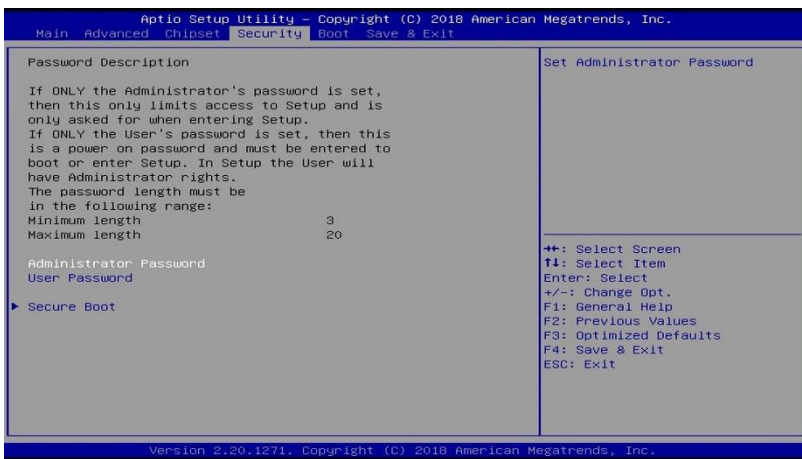

BIOS Setting	Description
Administrator Password	Sets an administrator password for the setup utility.
User Password	Sets a user password.
Secure Boot	Secure Boot feature is Active if Secure Boot is Enabled. Platform Key(PK) is enrolled and the System is in User mode. The mode change requires platform reset.
Secure Boot Mode	Secure Boot mode options: Standard or Custom. In Custom mode, Secure Boot Policy variables can be configured by a physically present user without full authentication.

4.7 Boot Settings

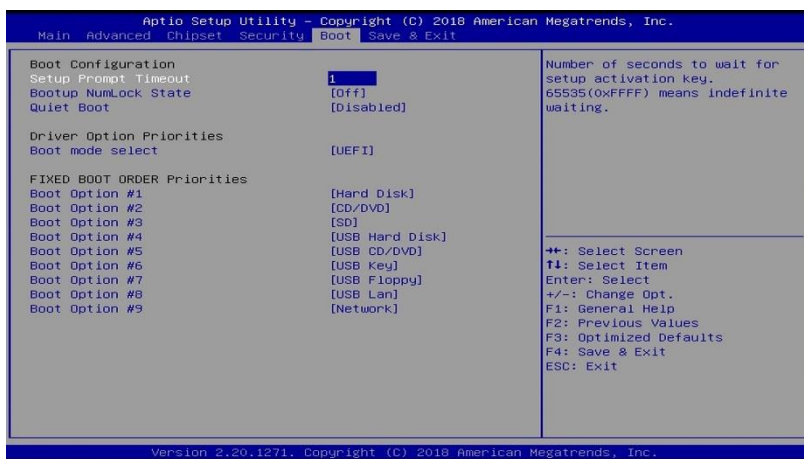

BIOS Setting	Description
Setup Prompt Timeout	Number of seconds to wait for setup activation key. 65535(0xFFFF) means indefinite waiting.
Bootup NumLock State	Selects the keyboard NumLock state.
Quiet Boot	Enables / Disables Quiet Boot option.
Boot mode select	Selects a Boot mode, Legacy / UEFI.
Boot Option Priorities	Sets the system boot order.

4.8 Save & Exit Settings

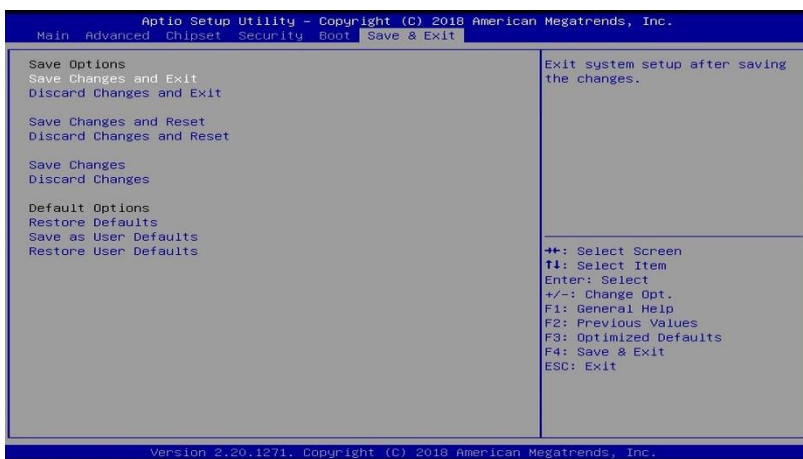

BIOS Setting	Description
Save Changes and Exit	Exits system setup after saving the changes.
Discard Changes and Exit	Exits system setup without saving any changes.
Save Changes and Reset	Resets the system after saving the changes.
Discard Changes and Reset	Resets system setup without saving any changes.
Save Changes	Saves changes done so far to any of the setup options.
Discard Changes	Discards changes done so far to any of the setup options.
Restore Defaults	Restores / Loads defaults values for all the setup options.
Save as User Defaults	Saves the changes done so far as User Defaults.
Restore User Defaults	Restores the user defaults to all the setup options.

This page is intentionally left blank.

Appendix

This section provides the mapping addresses of peripheral devices, the sample code of watchdog timer configuration, and types of on-board connectors.

A. I/O Port Address Map

Each peripheral device in the system is assigned a set of I/O port addresses which also becomes the identity of the device. The following table lists the I/O port addresses used.

Address	Device Description
0x00000A00-0x00000A0F	Motherboard resources
0x00000A10-0x00000A1F	Motherboard resources
0x00000A10-0x00000A1F	Motherboard resources
0x0000002E-0x0000002F	Motherboard resources
0x0000004E-0x0000004F	Motherboard resources
0x00000061-0x00000061	Motherboard resources
0x00000063-0x00000063	Motherboard resources
0x00000065-0x00000065	Motherboard resources
0x00000067-0x00000067	Motherboard resources
0x00000070-0x00000070	Motherboard resources
0x00000070-0x00000070	System CMOS/real time clock
0x00000080-0x00000080	Motherboard resources
0x00000092-0x00000092	Motherboard resources
0x000000B2-0x000000B3	Motherboard resources
0x00000680-0x0000069F	Motherboard resources
0x0000164E-0x0000164F	Motherboard resources
0x00000020-0x00000021	Programmable interrupt controller
0x00000024-0x00000025	Programmable interrupt controller
0x00000028-0x00000029	Programmable interrupt controller
0x0000002C-0x0000002D	Programmable interrupt controller
0x00000030-0x00000031	Programmable interrupt controller
0x00000034-0x00000035	Programmable interrupt controller
0x00000038-0x00000039	Programmable interrupt controller
0x0000003C-0x0000003D	Programmable interrupt controller

Address	Device Description
0x000000A0-0x000000A1	Programmable interrupt controller
0x000000A4-0x000000A5	Programmable interrupt controller
0x000000A8-0x000000A9	Programmable interrupt controller
0x000000AC-0x000000AD	Programmable interrupt controller
0x000000B0-0x000000B1	Programmable interrupt controller
0x000000B4-0x000000B5	Programmable interrupt controller
0x000000B8-0x000000B9	Programmable interrupt controller
0x000000BC-0x000000BD	Programmable interrupt controller
0x000004D0-0x000004D1	Programmable interrupt controller
0x00001854-0x00001857	Motherboard resources
0x000003F8-0x000003FF	Communications Port (COM1)
0x000002F8-0x000002FF	Communications Port (COM2)
0x000003E8-0x000003EF	Communications Port (COM3)
0x000002E8-0x000002EF	Communications Port (COM4)
0x000002F0-0x000002F7	Communications Port (COM5)
0x000002E0-0x000002E7	Communications Port (COM6)
0x00001800-0x000018FE	Motherboard resources
0x00000000-0x00000CF7	PCI Express Root Complex
0x00000D00-0x0000FFFF	PCI Express Root Complex
0x000000F0-0x000000F0	Numeric data processor
0x00004090-0x00004097	Standard SATA AHCI Controller
0x00004080-0x00004083	Standard SATA AHCI Controller
0x00004060-0x0000407F	Standard SATA AHCI Controller
0x0000FFF8-0x0000FFFF	Intel(R) Active Management Technology - SOL (COM7)
0x00003000-0x00003FFF	Intel(R) PCI Express Root Port #10 - A331
0x00002000-0x000020FE	Motherboard resources
0x00004000-0x0000403F	Intel(R) UHD Graphics 630

Address	Device Description
0x00000040-0x00000043	System timer
0x00000050-0x00000053	System timer
0x00000060-0x00000060	Standard PS/2 Keyboard
0x00000064-0x00000064	Standard PS/2 Keyboard
0x0000EFA0-0x0000EFBF	Intel(R) SMBus - A323

B. Interrupt Request Lines (IRQ)

Peripheral devices use interrupt request lines to notify CPU for the service required. The following table shows the IRQ used by the devices on board.

Level	Function
IRQ 8	System CMOS/real time clock
IRQ 4294967292	Intel(R) PCI Express Root Port #11 - A332
IRQ 4294967288	Intel(R) USB 3.1 eXtensible Host Controller - 1.10 (Microsoft)
IRQ 4	Communications Port (COM1)
IRQ 3	Communications Port (COM2)
IRQ 5	Communications Port (COM3)
IRQ 6	Communications Port (COM4)
IRQ 7	Communications Port (COM5)
IRQ 10	Communications Port (COM6)
IRQ 13	Numeric data processor
IRQ 4294967291	Standard SATA AHCI Controller
IRQ 54 ~ IRQ 204	Microsoft ACPI-Compliant System
IRQ 256 ~ IRQ 511	Microsoft ACPI-Compliant System
IRQ 19	Intel(R) Active Management Technology - SOL (COM7)
IRQ 4294967293	Intel(R) PCI Express Root Port #10 - A331
IRQ 4294967287	Intel(R) I211 Gigabit Network Connection
IRQ 4294967286	Intel(R) I211 Gigabit Network Connection
IRQ 4294967285	Intel(R) I211 Gigabit Network Connection
IRQ 4294967284	Intel(R) I211 Gigabit Network Connection
IRQ 4294967283	Intel(R) I211 Gigabit Network Connection
IRQ 4294967282	Intel(R) I211 Gigabit Network Connection
IRQ 4294967281	Intel(R) I211 Gigabit Network Connection
IRQ 4294967280	Intel(R) I211 Gigabit Network Connection

Level	Function
IRQ 4294967279	Intel(R) Management Engine Interface
IRQ 4294967289	Intel(R) UHD Graphics 630
IRQ 11	Intel(R) Thermal Subsystem - A379
IRQ 11	Intel(R) SMBus - A323
IRQ 0	System timer
IRQ 1	Standard PS/2 Keyboard
IRQ 4294967290	Intel(R) Ethernet Connection (7) I219-LM
IRQ 12	Microsoft PS/2 Mouse
IRQ 14	Intel(R) Serial IO GPIO Host Controller - 3450
IRQ 16	High Definition Audio Controller
IRQ 4294967294	Intel(R) PCIe Controller (x16) - 1901

C. Watchdog Timer Configuration

The Watchdog Timer (WDT) is used to generate a variety of output signals after a user programmable count. The WDT is suitable for use in the prevention of system lock-up, such as when software becomes trapped in a deadlock. Under these sorts of circumstances, the timer will count to zero and the selected outputs will be driven.

Under normal circumstance, you will need to restart the WDT at regular intervals before the timer counts to zero.

Sample Code:

```
//-----
//
// THIS CODE AND INFORMATION IS PROVIDED "AS IS" WITHOUT WARRANTY OF ANY
// KIND, EITHER EXPRESSED OR IMPLIED, INCLUDING BUT NOT LIMITED TO THE
// IMPLIED WARRANTIES OF MERCHANTABILITY AND/OR FITNESS FOR A PARTICULAR
// PURPOSE.
//
//-----
#include <dos.h>
#include <conio.h>
#include <stdio.h>
#include <stdlib.h>
#include "F81966.H"
//-----
int main (int argc, char *argv[]);
void EnableWDT(int);
void DisableWDT(void);
//-----
int main (int argc, char *argv[])
{
    unsigned char bBuf;
    unsigned char bTime;
    char **endptr;

    char SIO;

    printf("Fintek 81966 watch dog program\n");
    SIO = Init_F81966();
    if (SIO == 0)
    {
        printf("Can not detect Fintek 81966, program abort.\n");
        return(1);
    }
    //if (SIO == 0)

    if (argc != 2)
    {
        printf("Parameter incorrect!!\n");
        return (1);
    }
}
```

```

bTime = strtol(argv[1], endptr, 10);
printf("System will reset after %d seconds\n", bTime);

if (bTime)
{
    EnableWDT(bTime);
}
else
{
    DisableWDT();
    return 0;
}
}
//-----
void EnableWDT(int interval)
{
    unsigned char bBuf;

    bBuf = Get_F81966_Reg(0x2B);
    bBuf &= (~0x20);
    Set_F81966_Reg(0x2B, bBuf);           //Enable WDTO

    Set_F81966_LD(0x07);                 //switch to logic device 7
    Set_F81966_Reg(0x30, 0x01);         //enable timer

    bBuf = Get_F81966_Reg(0xF5);
    bBuf &= (~0x0F);
    bBuf |= 0x52;
    Set_F81966_Reg(0xF5, bBuf);         //count mode is second

    Set_F81966_Reg(0xF6, interval);     //set timer

    bBuf = Get_F81966_Reg(0xFA);
    bBuf |= 0x01;
    Set_F81966_Reg(0xFA, bBuf);         //enable WDTO output

    bBuf = Get_F81966_Reg(0xF5);
    bBuf |= 0x20;
    Set_F81966_Reg(0xF5, bBuf);         //start counting
}
//-----
void DisableWDT(void)
{
    unsigned char bBuf;

    Set_F81966_LD(0x07);                 //switch to logic device 7

    bBuf = Get_F81966_Reg(0xFA);
    bBuf &= ~0x01;
    Set_F81966_Reg(0xFA, bBuf);         //disable WDTO output

    bBuf = Get_F81966_Reg(0xF5);
    bBuf &= ~0x20;
    bBuf |= 0x40;
    Set_F81966_Reg(0xF5, bBuf);         //disable WDT
}
//-----

//-----
//
// THIS CODE AND INFORMATION IS PROVIDED "AS IS" WITHOUT WARRANTY OF ANY

```

```

// KIND, EITHER EXPRESSED OR IMPLIED, INCLUDING BUT NOT LIMITED TO THE
// IMPLIED WARRANTIES OF MERCHANTABILITY AND/OR FITNESS FOR A PARTICULAR
// PURPOSE.
//
//-----
#include "F81966.H"
#include <dos.h>
//-----
unsigned int F81966_BASE;
void Unlock_F81966 (void);
void Lock_F81966 (void);
//-----
unsigned int Init_F81966(void)
{
    unsigned int result;
    unsigned char ucDid;

    F81966_BASE = 0x4E;
    result = F81966_BASE;

    ucDid = Get_F81966_Reg(0x20);
    if (ucDid == 0x07)                //Fintek 81966
    {
        goto Init_Finish;
    }

    F81966_BASE = 0x2E;
    result = F81966_BASE;

    ucDid = Get_F81966_Reg(0x20);
    if (ucDid == 0x07)                //Fintek 81966
    {
        goto Init_Finish;
    }

    F81966_BASE = 0x00;
    result = F81966_BASE;

Init_Finish:
    return (result);
}
//-----
void Unlock_F81966 (void)
{
    outputb(F81966_INDEX_PORT, F81966_UNLOCK);
    outputb(F81966_INDEX_PORT, F81966_UNLOCK);
}
//-----
void Lock_F81966 (void)
{
    outputb(F81966_INDEX_PORT, F81966_LOCK);
}
//-----
void Set_F81966_LD( unsigned char LD)
{
    Unlock_F81966();
    outputb(F81966_INDEX_PORT, F81966_REG_LD);
    outputb(F81966_DATA_PORT, LD);
    Lock_F81966();
}
//-----

```

```
void Set_F81966_Reg( unsigned char REG, unsigned char DATA)
{
    Unlock_F81966();
    outportb(F81966_INDEX_PORT, REG);
    outportb(F81966_DATA_PORT, DATA);
    Lock_F81966();
}
//-----
unsigned char Get_F81966_Reg(unsigned char REG)
{
    unsigned char Result;
    Unlock_F81966();
    outportb(F81966_INDEX_PORT, REG);
    Result = inportb(F81966_DATA_PORT);
    Lock_F81966();
    return Result;
}
//-----

//-----
//
// THIS CODE AND INFORMATION IS PROVIDED "AS IS" WITHOUT WARRANTY OF ANY
// KIND, EITHER EXPRESSED OR IMPLIED, INCLUDING BUT NOT LIMITED TO THE
// IMPLIED WARRANTIES OF MERCHANTABILITY AND/OR FITNESS FOR A PARTICULAR
// PURPOSE.
//
//-----
#ifndef F81966_H
#define F81966_H            1
//-----
#define F81966_INDEX_PORT (F81966_BASE)
#define F81966_DATA_PORT (F81966_BASE+1)
//-----
#define F81966_REG_LD      0x07
//-----
#define F81966_UNLOCK     0x87
#define F81966_LOCK       0xAA
//-----
unsigned int Init_F81966(void);
void Set_F81966_LD( unsigned char);
void Set_F81966_Reg( unsigned char,
unsigned char); unsigned char
Get_F81966_Reg( unsigned char);
//-----
#endif // F81966_H
```

D. On-Board Connector Types

Function	Connector Name	Onboard Type	Compatible Mating Type for Reference
COM1 & COM2 RS-232/422/485 Ports	CN3	YIMTEX 40909AANSABR	D-SUB 9-pin
Front Panel Audio Connector	J1	E-call 0126-01-2821009	Dupont 2.54 mm 2*5-pin
Digital I/O Connector	J2	E-call 0196-01-200-100	Dupont 2.0 mm 2*5-pin
COM3, COM4, COM5, COM6 RS-232 Ports	J8 (COM3), J7 (COM4), J5 (COM5), J3 (COM6)	HAOGUO DF11-10S-PA66H	HRS DF11-10DS-2C
PS/2 Keyboard & Mouse Ports	J10	HAOGUO DF11-8S-PA66H	HRS DF11-8DS-2C
USB 2.0 Ports	J15	E-call 0126-01-2811009	Dupont 2.54 mm 2*5-pin
USB 3.1 Ports	J16	PINREX 52X-40-20GU52	USB 3.0 IDC 19-pin
Front Panel Settings Connector	J18	E-call 0126-01-203-200	Dupont 2.54 mm 2*5-pin
S3 Status Connector	J22	[E-CALL 0126-01-203-040	Dupont 2.54 mm 2*2-pin
ATX Power Connector	J23	HAOGUO 01-0018-03	ATX 4.2 mm 2*12-pin
ATX 12V Power Connector	ATX_12V_2X1	HAOGUO 01-0018-02	ATX 4.2 mm 2*4-pin
CPU Fan Power Connector	CPU_FAN1	Techbest W2- 031104132S1WT(A)- L	Molex 47054-1000
System Fan Power Connector	SYS_FAN1, SYS_FAN2	[TECHBEST W2- 031104132S1WT(A)- L	Molex 47054-1000