

OFP-21W33

21.5" Open Frame Panel PC

Quick Reference Guide

3rd Ed – 04 October, 2022

Copyright Notice

Copyright © 2022 Avalue Technology Inc., ALL RIGHTS RESERVED.



Federal Communication Commission Interference Statement

THIS DEVICE COMPLIES WITH PART 15 OF THE FCC RULES. OPERATION IS SUBJECT TO THE FOLLOWING TWO CONDITIONS: (1) THIS DEVICE MAY NOT CAUSE HARMFUL INTERFERENCE AND (2) THIS DEVICE MUST ACCEPT ANY INTERFERENCE RECEIVED, INCLUDING INTERFERENCE THAT MAY CAUSE UNDESIRE OPERATION.

Note: This equipment has been tested and found to comply with the limits for a Class A digital device, pursuant to Part 15 of FCC Rules. These limits are designed to provide reasonable protection against harmful interference in a residential installation. This equipment generates, uses and can radiate radio frequency energy and, if not installed and used in accordance with the instruction, may cause harmful interference to radio communications. However, there is no guarantee that interference will not occur in a particular installation. If this equipment does cause harmful interference to radio or television reception, which can be determined by turning the equipment off and on, the user is encouraged to try to correct the interference by one or more of the following measures:

- Reorient or relocate the receiving antenna.
- Increase the separation between the equipment and receiver.
- Connect the equipment into an outlet on a circuit different from that to which the receiver is connected.
- Consult the dealer or an experienced radio/TV technician for help.

Notice:

- (1) A Unshielded-type power cord is required in order to meet FCC emission limits and also to prevent interference to the nearby radio and television reception. It is essential that only the supplied power cord be used.
- (2) Use only shielded cables to connect I/O devices to this equipment.
- (3) Changes or modifications not expressly approved by the party responsible for compliance could void the user's authority to operate the equipment.

FCC RF Radiation Exposure Statement

This Wireless LAN radio device has been evaluated under FCC Bulletin OET 65 and found compliant to the requirements as set forth in CFR 47 Sections 2.1091, 2.1093, and 15.247 (b) (4) addressing RF Exposure from radio frequency devices. The radiated output power of this Wireless LAN device is far below the FCC radio frequency exposure limits. Nevertheless, this device shall be used in such a manner that the potential for human contact during normal operation is minimized. When nearby persons has to be kept to ensure RF exposure compliance, in order to comply with RF exposure limits established in the ANSI C95.1 standards, the distance between the antennas and the user should not be less than 20 cm.

WARNING

“CAUTION – Use suitable mounting apparatus to avoid risk of injury.”

“CAUTION – This is a Class A product. In a domestic environment this product may cause radio interference in which case the user may be required to take adequate measures”

“CAUTION –Risk of explosion if battery is replaced by an incorrect type. Dispose of used batteries according to the instructions.”

“CAUTION - Use a power cord that matches the voltage of the power outlet, which has been approved and complies with the safety standard of your particular country.”

“WARNING – To avoid risk of electric shock, this equipment must only be connected to a supply mains with protective earth.”

Content

| | |
|---|-----------|
| 1. Getting Started | 8 |
| 1.1 Safety Precautions | 8 |
| 1.2 Packing List | 8 |
| 1.3 System Specifications | 9 |
| 1.4 System Overview..... | 12 |
| 1.4.1 Right View | 12 |
| 1.4.2 Left View | 12 |
| 1.4.3 Bottom View | 12 |
| 1.5 System Dimensions..... | 13 |
| 1.5.1 Front and Rear side | 13 |
| 1.6 Panel Mounting | 14 |
| 1.7 Wall Mounting..... | 27 |
| 2. Hardware Configuration | 39 |
| 2.1 OFP-21W33 connector mapping | 40 |
| 2.1.1 Serial Port connector (COM)..... | 40 |
| 2.1.2 DC power-in connector (DC in)..... | 41 |
| 2.2 Product Overview | 42 |
| 2.3 Jumper and Connector List..... | 44 |
| 2.4 Setting Jumpers & Connectors | 47 |
| 2.4.1 Serial port 1/2/3/4/5/6 pin9 signal select (JRI1/JRI2/JRI3/JRI4/JRI5/JRI6)..... | 47 |
| 2.4.2 SATA2/MSATA1 mPCIe slot selector (JMSW1)..... | 47 |
| 2.4.3 LVDS Back Light power selection (JSBKL1) | 48 |
| 2.4.4 AT/ATX Power Mode Select (JSATX1) | 48 |
| 2.4.5 Clear CMOS (CMOS1) | 49 |
| 2.4.6 LCD Inverter connector (JBKL1)..... | 49 |
| 2.4.7 Serial port 1/2 connector (COM1/2)..... | 50 |
| 2.4.8 Serial port 3/4/6 connector (COM3/4/6)..... | 50 |
| 2.4.9 Serial port 5 connector (COM5)..... | 51 |
| 2.4.10 Serial Port 1 RS485/422 Mode connector (JRS485)..... | 51 |
| 2.4.11 General purpose I/O connector (DIO1) | 52 |
| 2.4.12 SATA Power connector 1/2 (SPWR1/2)..... | 52 |
| 2.4.13 Power connector (PWR1)..... | 53 |
| 2.4.14 USB2.0 connector (USB3)..... | 53 |
| 2.4.15 USB2.0 connector (USBH1) | 54 |
| 2.4.16 USB2.0 connector (USBH2) | 54 |
| 2.4.17 LVDS connector (LVDS1)..... | 55 |

OFP-21W33

| | | |
|---------------------------|---|----|
| 2.4.18 | Battery connector (BT1) | 56 |
| 2.4.19 | Front Audio connector (FAUD1) | 56 |
| 2.3.19.1 | Signal Description –Front Audio connector (FAUD1) | 56 |
| 2.4.20 | LPC connector (JLPC1)..... | 57 |
| 2.4.21 | EC_Program (EC1)..... | 57 |
| 2.4.22 | SPI connector (SPI1)..... | 58 |
| 2.4.23 | Sony/Philips Digital Interface (SPDIF1)..... | 58 |
| 2.4.24 | Speaker connector (SPK1)..... | 59 |
| 2.4.25 | Front Panel connector 1 (FPT1)..... | 59 |
| 2.4.26 | Front Panel connector 2 (FPT2)..... | 60 |
| 2.4.27 | LED indicator connector 1 (LED1)..... | 60 |
| 2.4.28 | LED indicator connector 2 (LED2)..... | 61 |
| 2.4.29 | CPU fan connector (FAN1)..... | 61 |
| 2.4.30 | Digital Microphone connector (DMIC1) | 62 |
| 2.4.31 | eDP connector (EDP1) | 62 |
| 2.4.32 | I2C connector (I2C1) | 63 |
| 3.BIOS Setup | 64 | |
| 3.1 | Introduction..... | 65 |
| 3.2 | Starting Setup..... | 65 |
| 3.3 | Using Setup | 66 |
| 3.4 | Getting Help..... | 67 |
| 3.5 | In Case of Problems | 67 |
| 3.6 | BIOS setup | 68 |
| 3.6.1 | Main Menu | 68 |
| 3.6.1.1 | System Language | 69 |
| 3.6.1.2 | System Date..... | 69 |
| 3.6.1.3 | System Time | 69 |
| 3.6.2 | Advanced Menu | 69 |
| 3.6.2.1 | Trusted Computing..... | 70 |
| 3.6.2.2 | ACPI Settings | 70 |
| 3.6.2.3 | IT8528 Super IO Configuration | 71 |
| 3.6.2.3.1 | Serial Port 1 Configuration | 72 |
| 3.6.2.3.2 | Serial Port 2 Configuration | 73 |
| 3.6.2.3.3 | Serial Port 3 Configuration | 73 |
| 3.6.2.3.4 | Serial Port 4 Configuration | 74 |
| 3.6.2.3.5 | Serial Port 5 Configuration | 74 |
| 3.6.2.4 | H/W Monitor | 75 |
| 3.6.2.4.1 | Smart Fan Mode Configuration | 75 |
| 3.6.2.5 | S5 RTC Wake Settings | 76 |
| 3.6.2.6 | Serial Port Console Redirection | 78 |

| | | |
|-------------|--|------------|
| 3.6.2.7 | CPU Configuration | 78 |
| 3.6.2.7.1 | Socket 0 CPU Information..... | 79 |
| 3.6.2.7.2 | CPU Power Management Configuration | 80 |
| 3.6.2.8 | Network Stack Configuration..... | 81 |
| 3.6.2.9 | NVMe Configuration | 82 |
| 3.6.2.10 | CSM Configuration | 82 |
| 3.6.2.11 | USB Configuration..... | 83 |
| 3.6.2.12 | Security Configuration | 84 |
| 3.6.2.13 | System Component..... | 85 |
| 3.6.3 | Chipset | 85 |
| 3.6.3.1 | North Bridge | 86 |
| 3.6.3.2 | South Bridge..... | 87 |
| 3.6.3.3 | Uncore Configuration..... | 87 |
| 3.6.3.4 | South Cluster Configuration | 89 |
| 3.6.3.4.1 | HD-Audio Configuration | 89 |
| 3.6.3.4.2 | PCI Express Configuration..... | 90 |
| 3.6.3.4.2.1 | PCI Express Root Port 3(i210/211) | 91 |
| 3.6.3.4.2.2 | PCI Express Root Port 4(i210/211) | 92 |
| 3.6.3.4.2.3 | PCI Express Root Port 5(M.2/PCIe slot) | 93 |
| 3.6.3.4.2.4 | PCI Express Root Port 6(mPCIe) | 94 |
| 3.6.3.4.3 | SATA Drives..... | 95 |
| 3.6.3.4.4 | SCC Configuration | 96 |
| 3.6.3.4.5 | USB Configuration..... | 96 |
| 3.6.4 | Security | 97 |
| 3.6.4.1 | Secure Boot..... | 98 |
| 3.6.5 | Boot..... | 99 |
| 3.6.6 | Save and exit | 100 |
| 3.6.6.1 | Save Changes and Reset | 100 |
| 3.6.6.2 | Discard Changes and Reset | 100 |
| 3.6.6.3 | Restore Defaults..... | 100 |
| 3.6.6.4 | Launch EFI Shell from filesystem device | 100 |
| 4. | Drivers Installation..... | 101 |
| 4.1 | Install Chipset Driver | 102 |
| 4.2 | Install VGA Driver | 103 |
| 4.3 | Install Serial IO Driver..... | 104 |
| 4.4 | Install TXE Driver..... | 105 |
| 4.5 | Install Audio Driver (For Realtek ALC662 HD Audio) | 106 |
| 4.6 | Install LAN Driver (For Intel I211AT)..... | 107 |
| 5. | Development Resource..... | 109 |

1. Getting Started

1.1 Safety Precautions

Warning!



Always completely disconnect the power cord from your chassis whenever you work with the hardware. Do not make connections while the power is on. Sensitive electronic components can be damaged by sudden power surges. Only experienced electronics personnel should open the PC chassis.

Caution!



Always ground yourself to remove any static charge before touching the CPU card. Modern electronic devices are very sensitive to static electric charges. As a safety precaution, use a grounding wrist strap at all times. Place all electronic components in a static-dissipative surface or static-shielded bag when they are not in the chassis.

1.2 Packing List

- 1 x OFP-21W33 Open Frame Panel PC



If any of the above items is damaged or missing, contact your retailer.

1.3 System Specifications

| Board Specification | |
|-------------------------------|---|
| Mother Board | EMX-APLP (EMX-APLP-3455-A1R (LVDS Ver)) |
| CPU | Intel® Celeron® J3455 (F1 stepping) |
| CPU Cooler (Type) | Fanless |
| Memory | 2 x 204-pin DDR3L 1600 & 1333MHz SO-DIMM supports up to 16GB |
| Wireless LAN | IEEE802.11 ac/a/b/g/n 2.4 GHz, 5 GHz (Optional) |
| Bluetooth | BT4.0 (Optional) |
| Operating System | Windows 10 Ubuntu 16.04 Android x86 8.1 |
| Expansion Card | 1 x full size Mini PCI-e support mSATA (SATA III and mSATA By auto switch IC) with 1 x SIM card slot 1 x M.2 (2230) A-Key, support WiFi module |
| Storage | |
| Solid State Drive | N/A (Reserve space for future 1 x 2.5" Drive Bay design) |
| Other Storage Device | Default by 1 x mSATA (Shared mPCIe) |
| Panel | |
| LCD Panel | 21.5" LVDS Panel, INNOLUX M215HJJ-L30 TFT LCD 1920*1080 |
| LCD Control Board | Built in |
| B/L Inverter/Converter | LED driving board for D2626514G1PA |
| Touch Screen | 21.5" PCAP Touch, Henghao: HS-T215NN01-G8SA |
| Touch Controller | EETI |
| External I/O | |
| Serial Port | 1 x RS232(default)/422/485 4 x RS232 (option) |
| USB Port | 4 x USB 3.0, 4 x USB 2.0 (option) |
| Video Port | DP++, HDMI/DP(HDMI/DP: 3840 x 2160 @ 30Hz, 2560 x 1600 @ 30Hz) |
| Audio Port | Line-out, Mic-in |
| LAN Port | 2 x RJ45 LAN port (2 x Intel® I211AT, 10/100/1000 Base-Tx Gigabit Ethernet Compatible) |
| Wireless LAN | 2 x Antenna Mounting with Dust Cover |

OFP-21W33

| | |
|-----------------------------|---|
| Antenna | |
| Switch | 2 pins Phoenix connector default for system reset function (option for power on/off) *Do not connect any power source to this connector to avoid damage of motherboard |
| Mechanical | |
| Power Type | +12V~24V DC in |
| Power Connector Type | 3 pins Phoenix connector and Lockable DC in |
| Dimension | 501.88 x 296.2 x 53.4 mm |
| Weight | 4.1 Kg |
| Color | Silver |
| Fanless | Fanless |
| OS Support | Windows 10 Ubuntu 16.04 Android x86 8.1 |
| Reliability | |
| EMI Test | CE/FCC Class A |
| Vibration Test | <p>Random Vibration Operation</p> <ol style="list-style-type: none"> 1 Test PSD : 0.00454G²/Hz , 1.5 Grms 2 System condition : operation mode 3 Test frequency : 5~500 Hz 4 Test axis : X,Y and Z axis 5 Test time : 30 minutes per each axis 6 IEC60068-2-64 Test Fh 6 Storage : mSATA <p>Sine Vibration test (Non-operation)</p> <ol style="list-style-type: none"> 1 Test Acceleration : 2G 2 Test frequency : 5~500 Hz 3 Sweep : 1 Oct/ per one minute. (logarithmic) 4 Test Axis : X,Y and Z axis 5 Test time :30 min. each axis 6 System condition : Non-Operating mode 7. Reference IEC 60068-2-6 Testing procedures <p>Package Vibration Test:</p> <ol style="list-style-type: none"> 1 Test PSD : 0.026G²/Hz , 2.16 Grms 2 Test frequency : 5~500 Hz 3 Test axis : X,Y and Z axis |

| | |
|------------------------------|--|
| | <p>4 Test time : 30 minutes per each axis</p> <p>5 IEC 60068-2-64 Test Fh</p> |
| Mechanical Shock Test | <p>1 Wave form : Half Sine wave</p> <p>2 Acceleration Rate : 10g for operation mode</p> <p>3 Duration Time : 11ms</p> <p>4 No. of shock : Z axis 300 times</p> <p>5 Test Axis : Z axis</p> <p>6 operation mode</p> <p>7 Reference IEC 60068-2-27 testing procedures</p> <p>Test Eb : Shock Test</p> |
| Drop Test | <p>Package drop test</p> <p>Reference ISTA 2A, Method : IEC-60068-2-32 Test:Ed</p> <p>Test Ea : Drop Test</p> <p>1 Test phase : One corner, three edges, six faces</p> <p>2 Test high : 96.5cm</p> <p>3 Package weight : 5Kg</p> <p>4 Test drawing</p> <p>4-feet drop resistance without package</p> <p>MIL-STD-810G</p> |
| Operating Temperature | 0°C ~ 45°C (32°F ~ 113°F) |
| Operating Humidity | 0% ~ 90% Relative Humidity, Non-condensing |
| Storage Temperature | -20°C ~ 60°C (-4°F ~ 140°F) |
| Power Consumption | Max. load 38.87W with intel J3455/4GB/32GB(mSATA), 12V DC in |



Note: Specifications are subject to change without notice.

1.4 System Overview

1.4.1 Right View

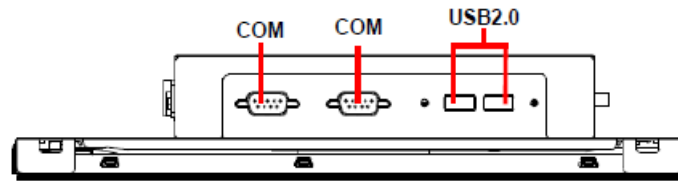

1.4.2 Left View

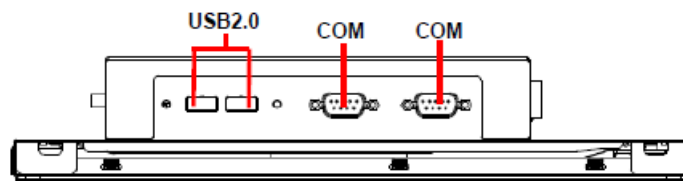

1.4.3 Bottom View

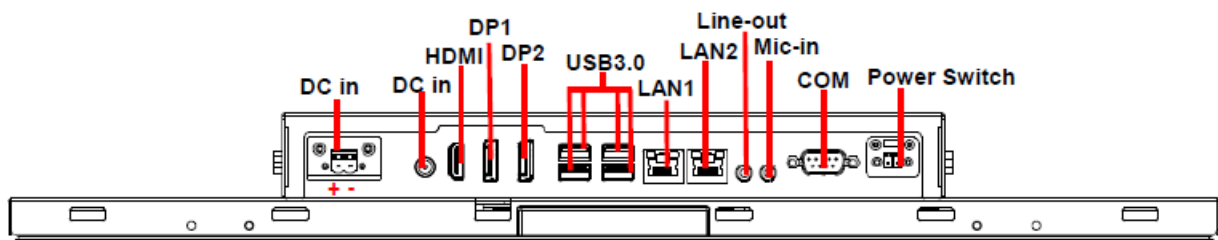

Connectors

| Label | Function | Note |
|--------------|--|--|
| COM | 5 x Serial port connector | 1 x RS232(default)/422/485 4 x RS232(option) |
| HDMI | HDMI connector | |
| USB3.0 | 4 x USB 3.0 connector | |
| USB2.0 | 4 x USB 2.0 connector(option) | |
| LAN1/2 | 2 x RJ-45 Ethernet | |
| Line-out | Line-out jack | |
| Mic-in | Mic-in audio jack | |
| DC in | DC power-in connector | |
| DC in | 2 pins Phoenix connector | |
| DP1/2 | 2 x DP connector | |
| Power Switch | 2 pins Phoenix connector default for system reset function (option for power on/off) | Do not connect any power source to this connector to avoid damage of motherboard |

1.5 System Dimensions

1.5.1 Front and Rear side

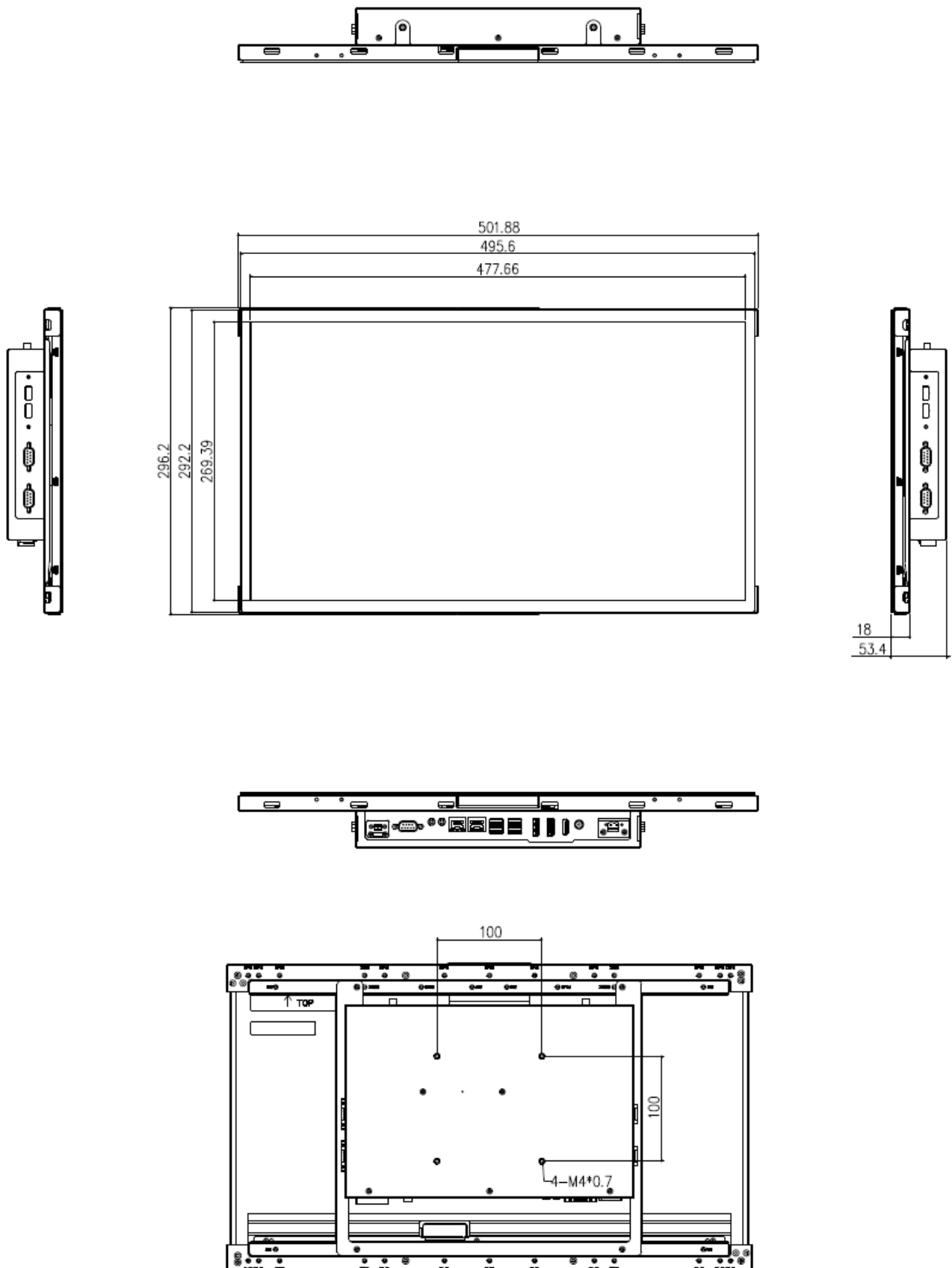

1.6 Panel Mounting

Panel mount is the solution for mounting OFP into the opening of wall (or cabinet).

The dimension of opening is as below:

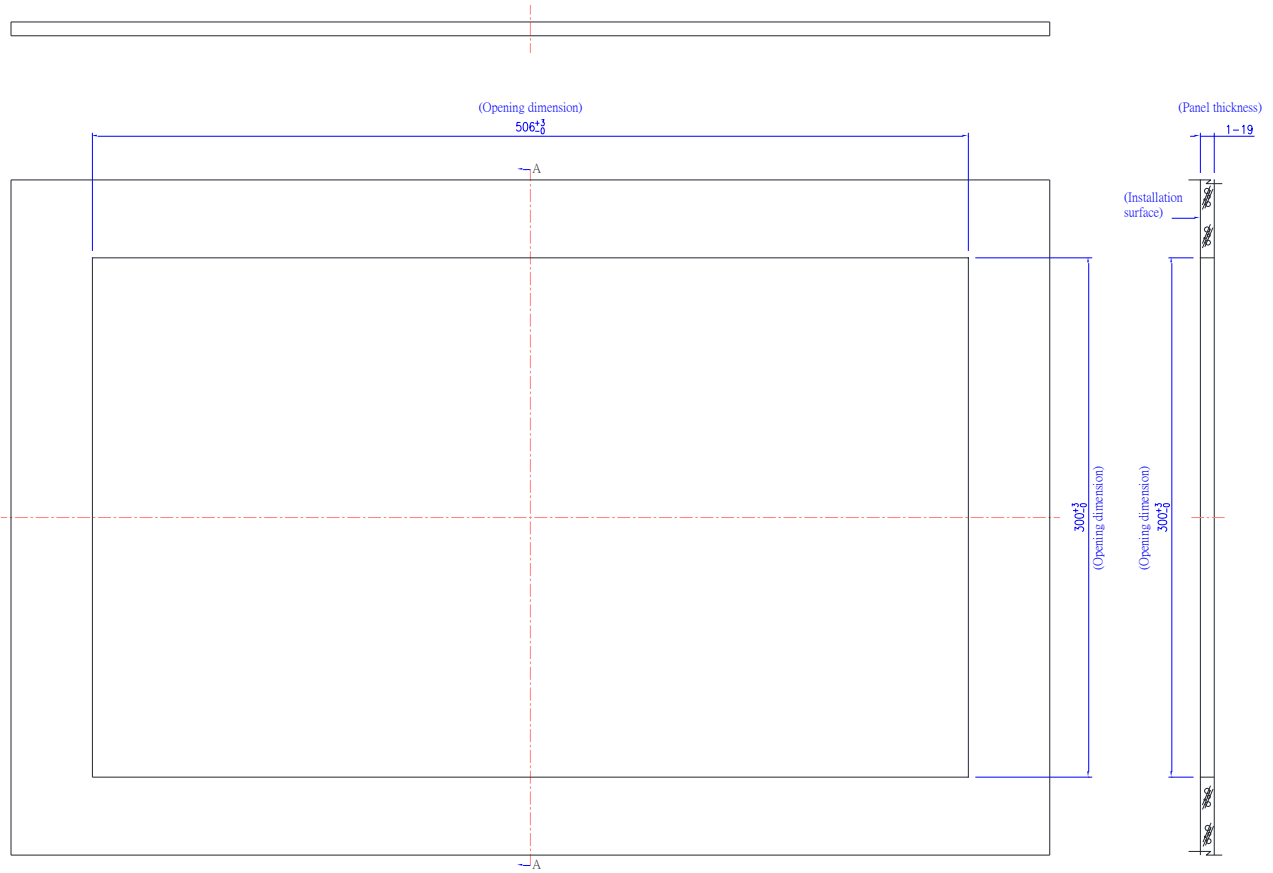

(Unit: mm)

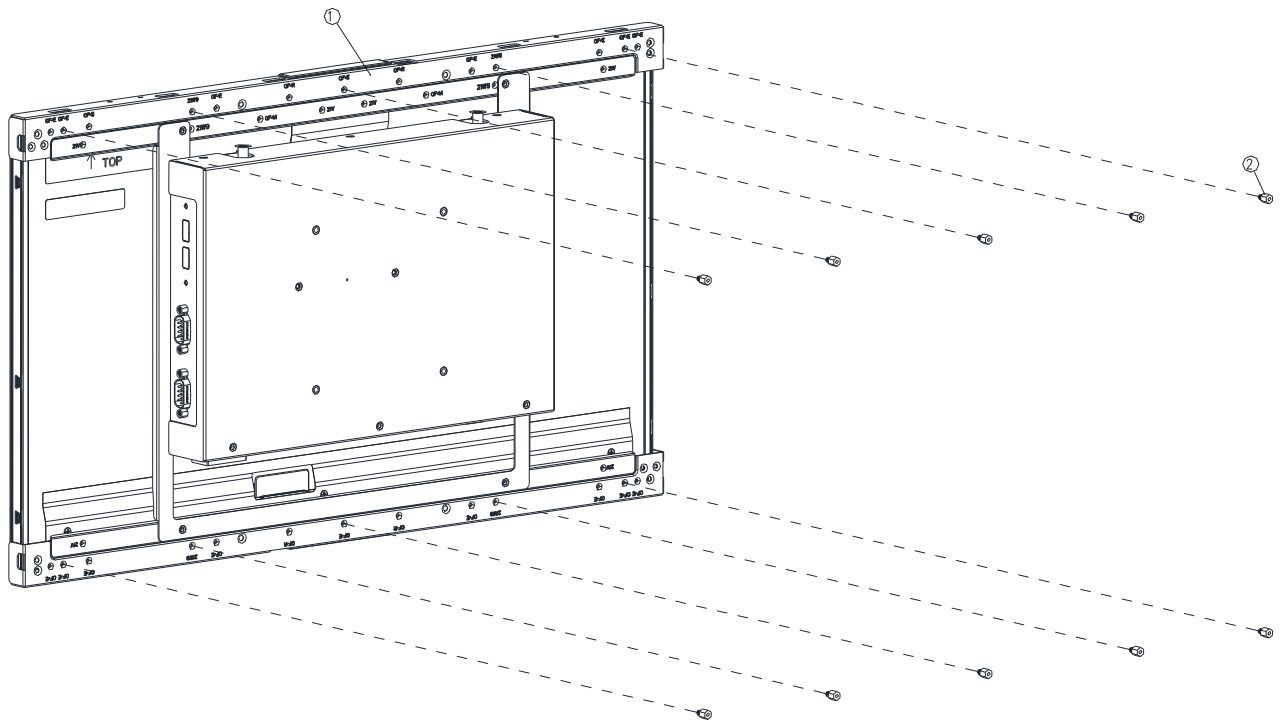

Step1. Insert and fasten 10 pcs Hexagon Studs on each side of the OFP-21W33 Panel Bracket.

| | | |
|------|--------------|----------|
| 2 | Hexagon Stud | 10 |
| 1 | OFP-21W33 | 1 |
| Item | Part Name | Quantity |

OFP-21W33

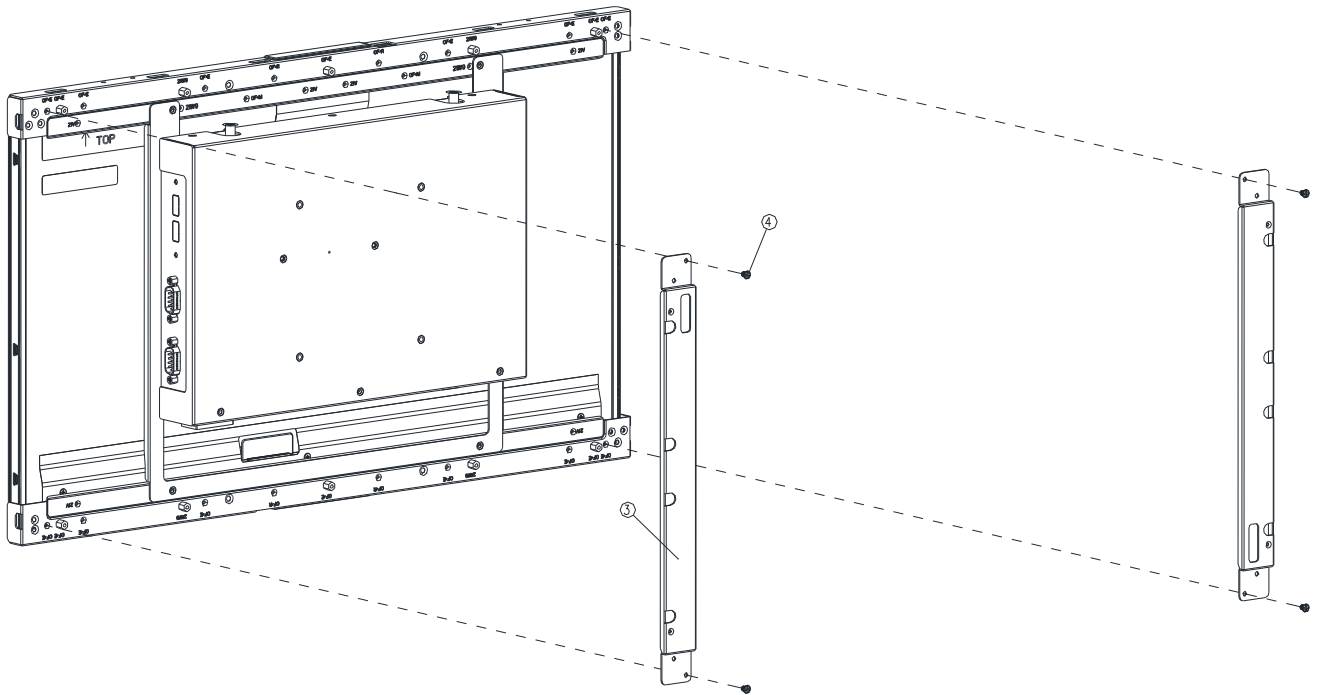

Step2. Assemble the 2pcs Bracket-RL on the left and right sides of the OFP-21W33 bracket by fastening 4 pcs screws on each side.

| | | |
|------|------------|----------|
| 4 | Screw | 4 |
| 3 | Bracket-RL | 2 |
| Item | Part Name | Quantity |

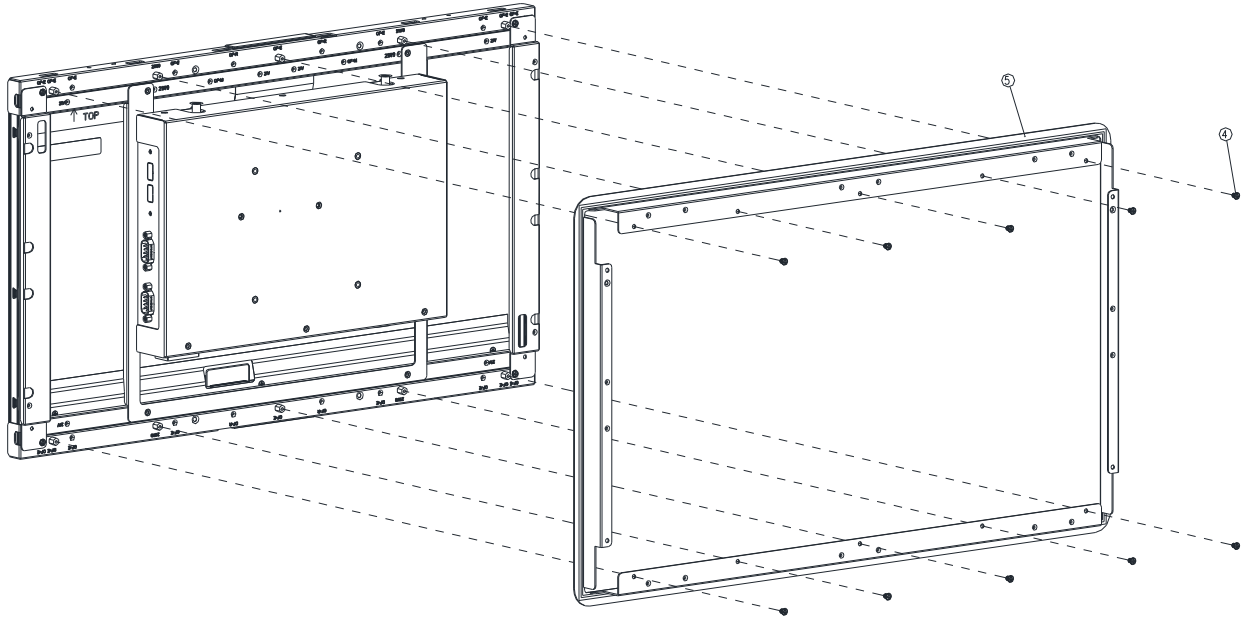

Step3. Assemble the Front Bracket to OFP-21W33 and fasten 10 pcs screws on the corresponding Hexagon Studs.

| | | |
|------|---------------|----------|
| 5 | Front Bracket | 1 |
| 4 | Screw | 10 |
| Item | Part Name | Quantity |

OFP-21W33

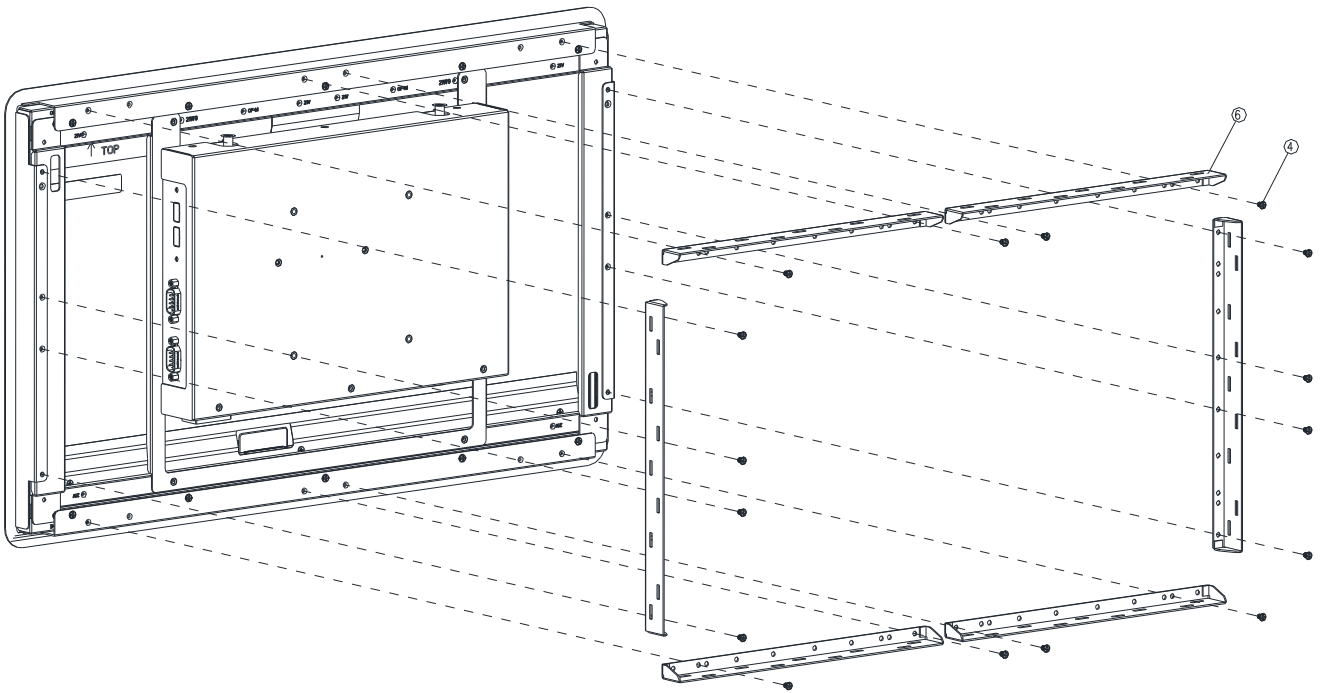

Step4. Assemble the 6pcs Panel kit Brackets on the Front Bracket and fasten the 16 pcs screws to the corresponding holes.

| | | |
|------|-------------------|----------|
| 4 | Screw | 16 |
| 6 | Panel kit Bracket | 6 |
| Item | Part Name | Quantity |



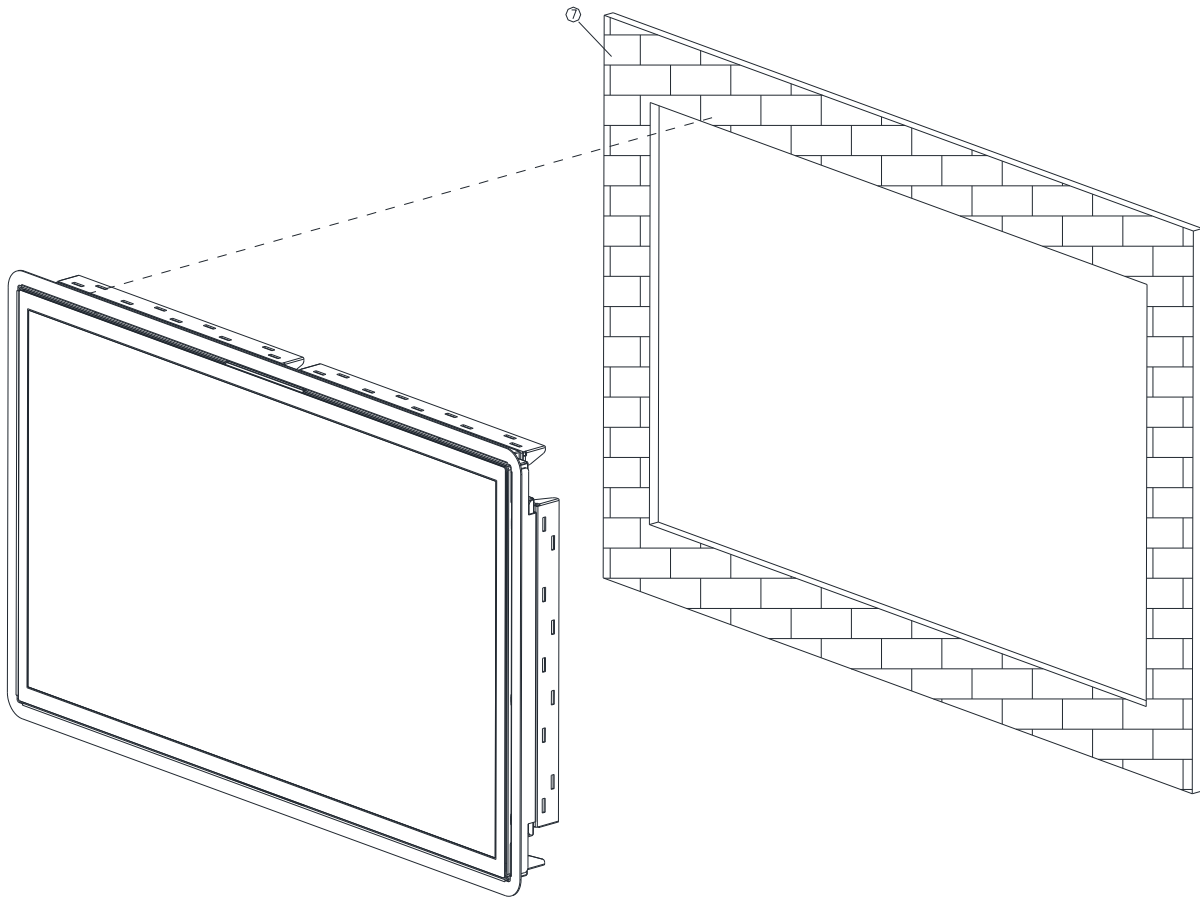

(outside the wall (or cabinet) opening)

Step5. Embed the OFP-21W33 semi-finished product into the wall (or cabinet) opening.

| | | |
|------|-----------|----------|
| 7 | Wall | 1 |
| Item | Part Name | Quantity |

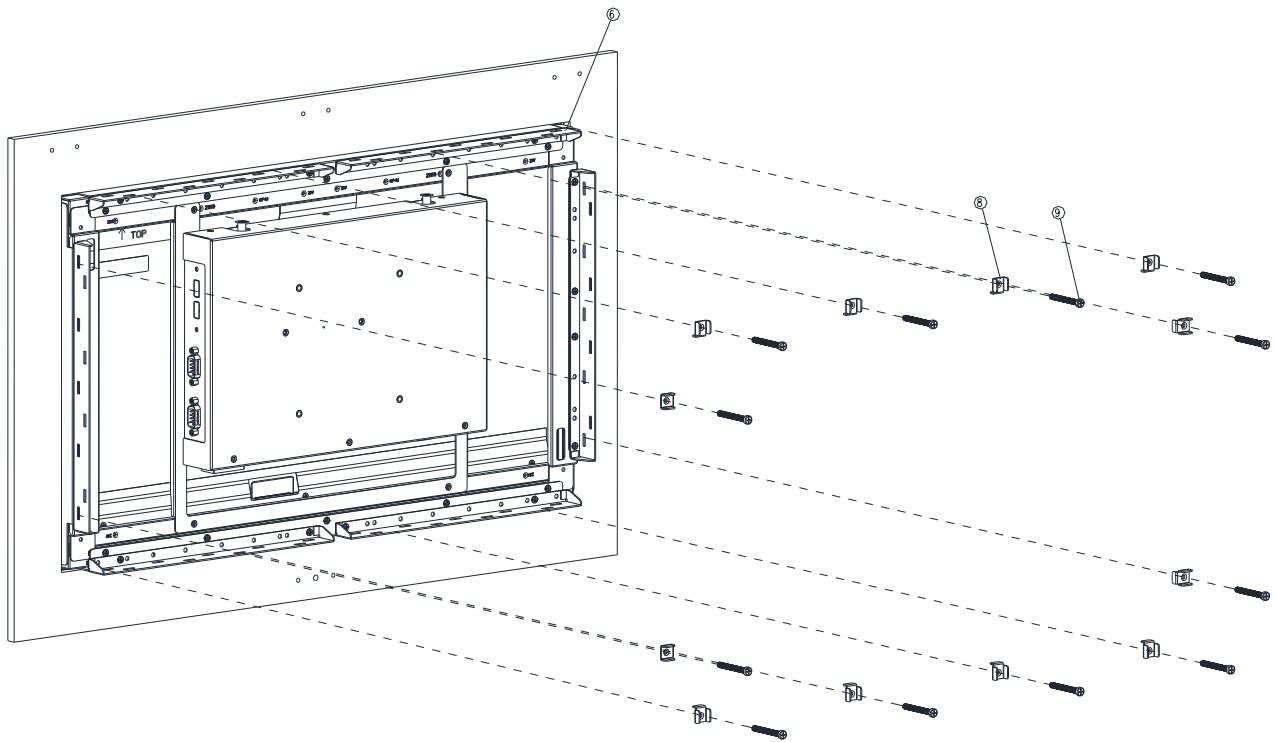

(inside the wall (or cabinet))

Step6. Fasten the Panel mount screw*12 to the Panel mount kit bracket*12 (as shown in Figure 6-1), and then attach them to the Panel Kit Bracket*6 fixing slots.

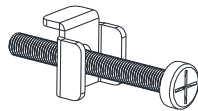
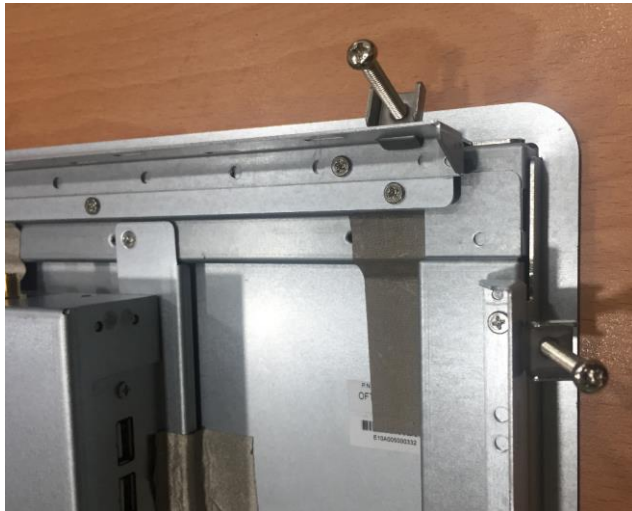
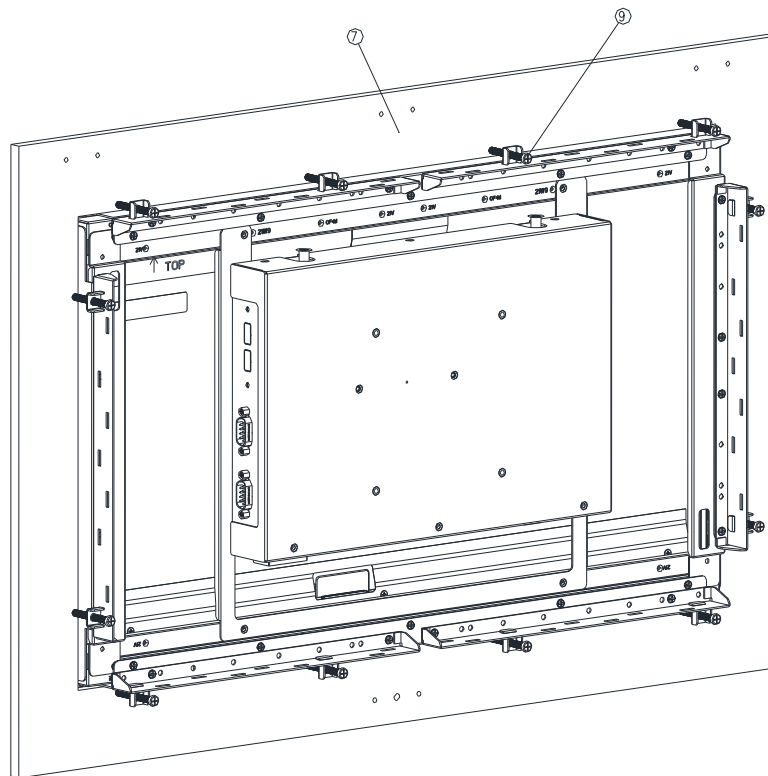

Figure 6-1

| | | |
|------|-------------------------|----------|
| 9 | Panel mount Screw | 12 |
| 8 | Panel Mount Kit Bracket | 12 |
| 6 | Panel Kit Bracket | 6 |
| Item | Part Name | Quantity |

Quick Reference Guide





Step7. Fasten the Panel mount screw*12 against the wall, so that the entire module can be secured by the Panel mount screws and Panel mount kit brackets.

| | | |
|------|-------------------|----------|
| 9 | Panel mount Screw | 12 |
| 7 | Wall | 1 |
| Item | Part Name | Quantity |



(The diagram is demonstrated by OFT-10W01, but the concept “the entire module can be secured by fastening the Panel mount screws against the wall” is the same)

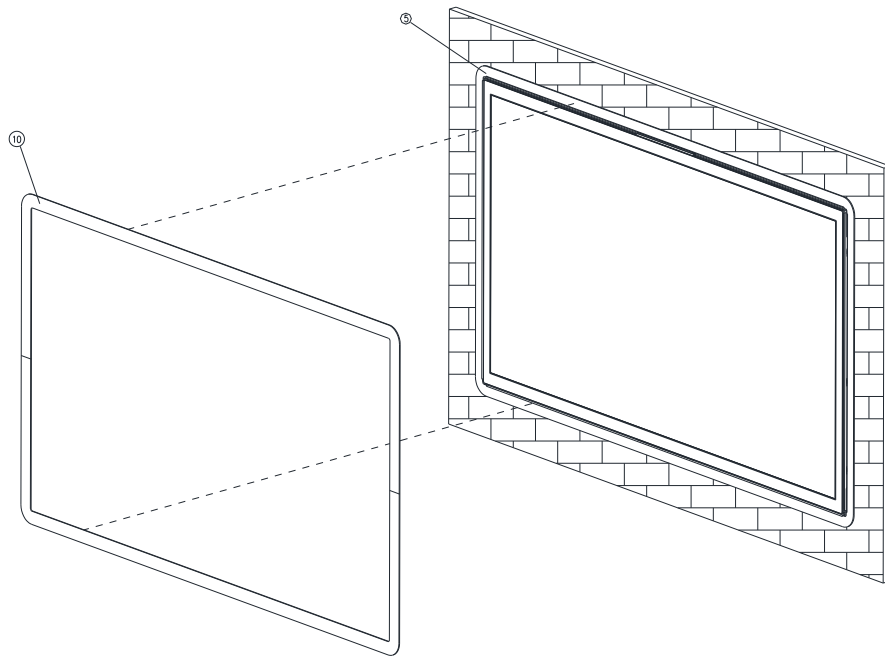

Step8. Paste the 2 pcs U Plates on the Front Bracket to complete installation.

| | | |
|------|---------------|----------|
| 10 | U Plate | 2 |
| 5 | Front Bracket | 1 |
| Item | Part Name | Quantity |



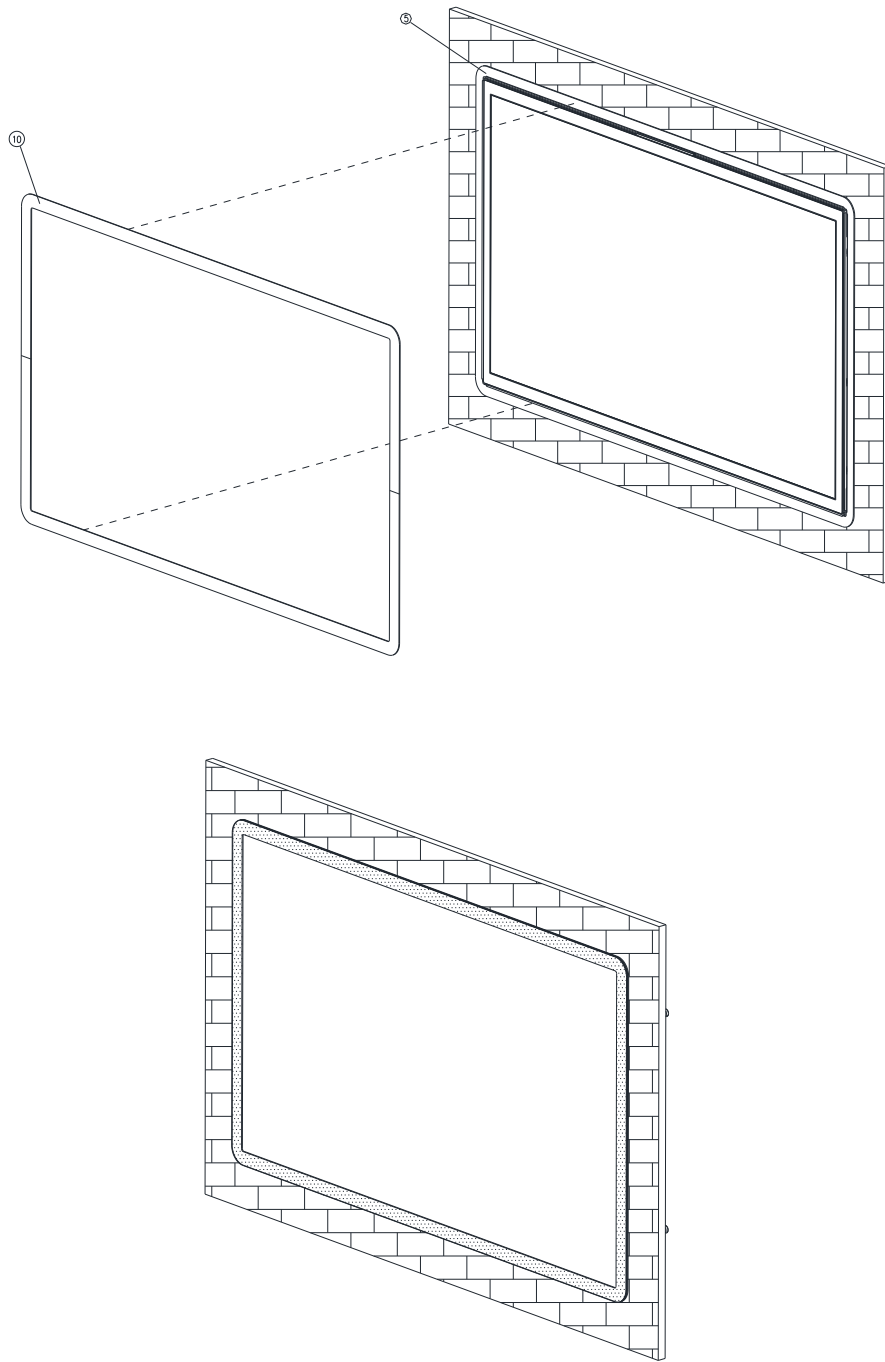

Step9. Paste the Decoration Plate on the U Plate to complete installation.

| | | |
|------|------------------|----------|
| 11 | Decoration Plate | 1 |
| 10 | U Plate | 2 |
| Item | Part Name | Quantity |



1.7 Wall Mounting

Wall mount is the solution for mounting OFP into the wall.

Size of the opening:

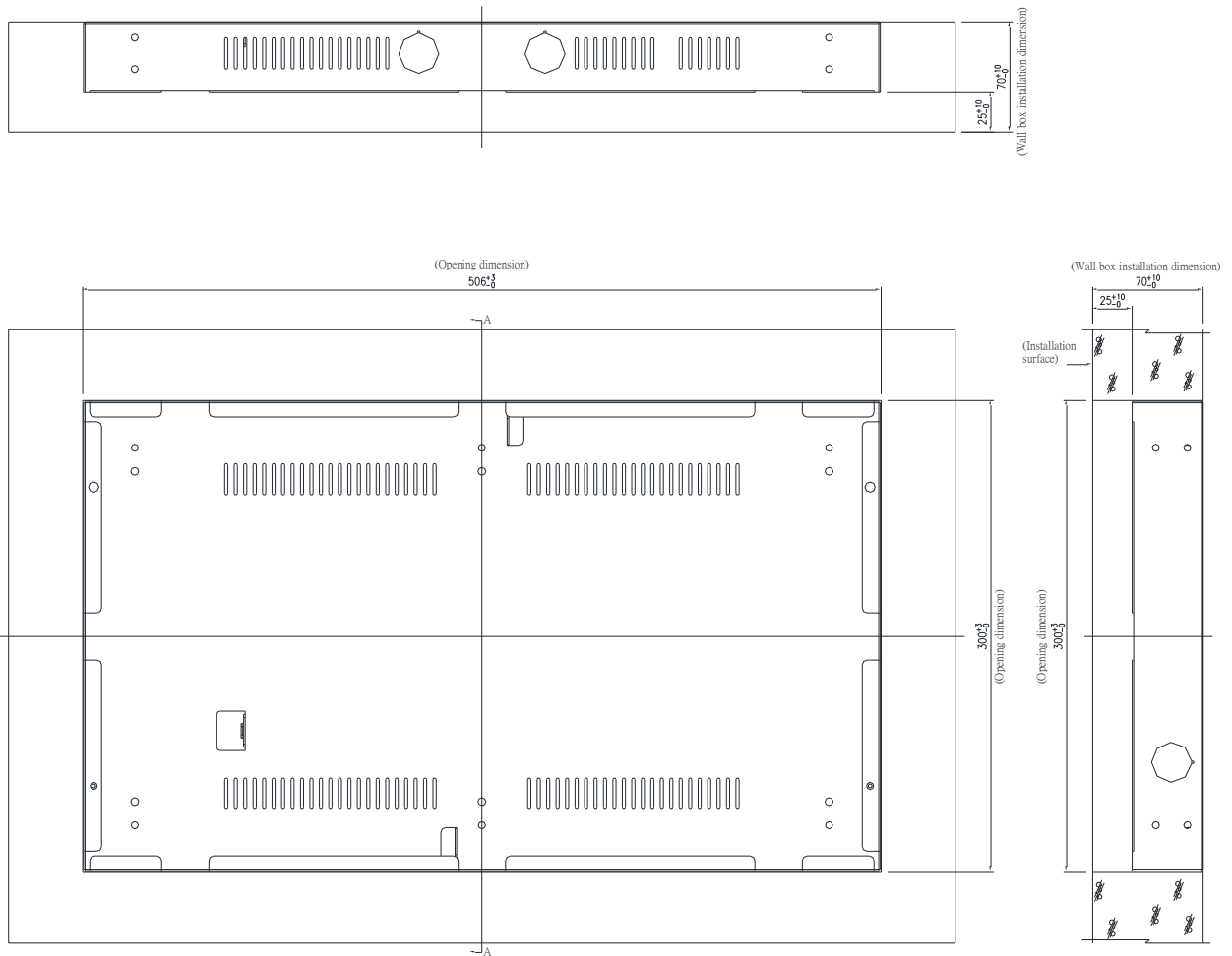

(Unit: mm)

OFP-21W33

Screw hole location:

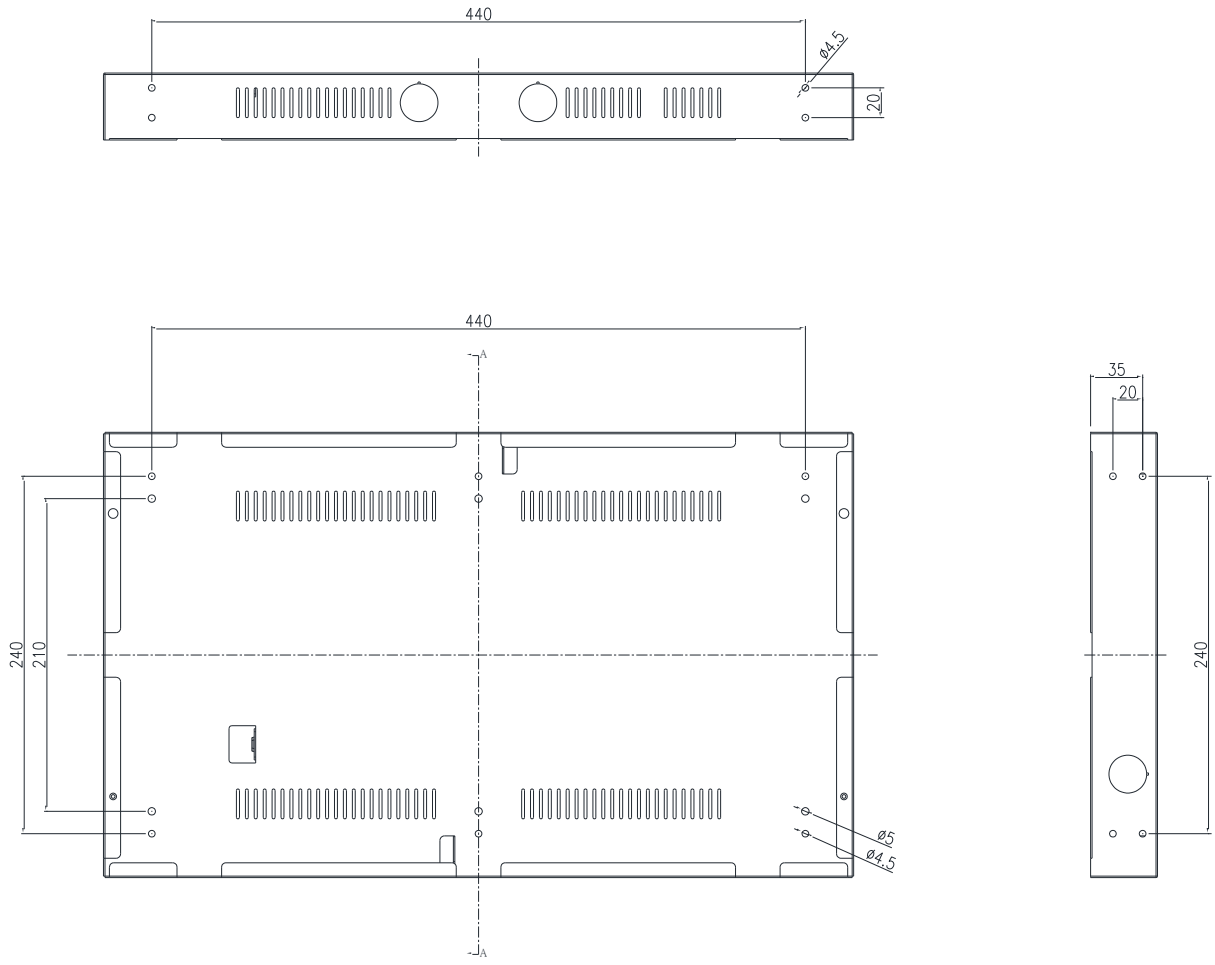

(Unit: mm)

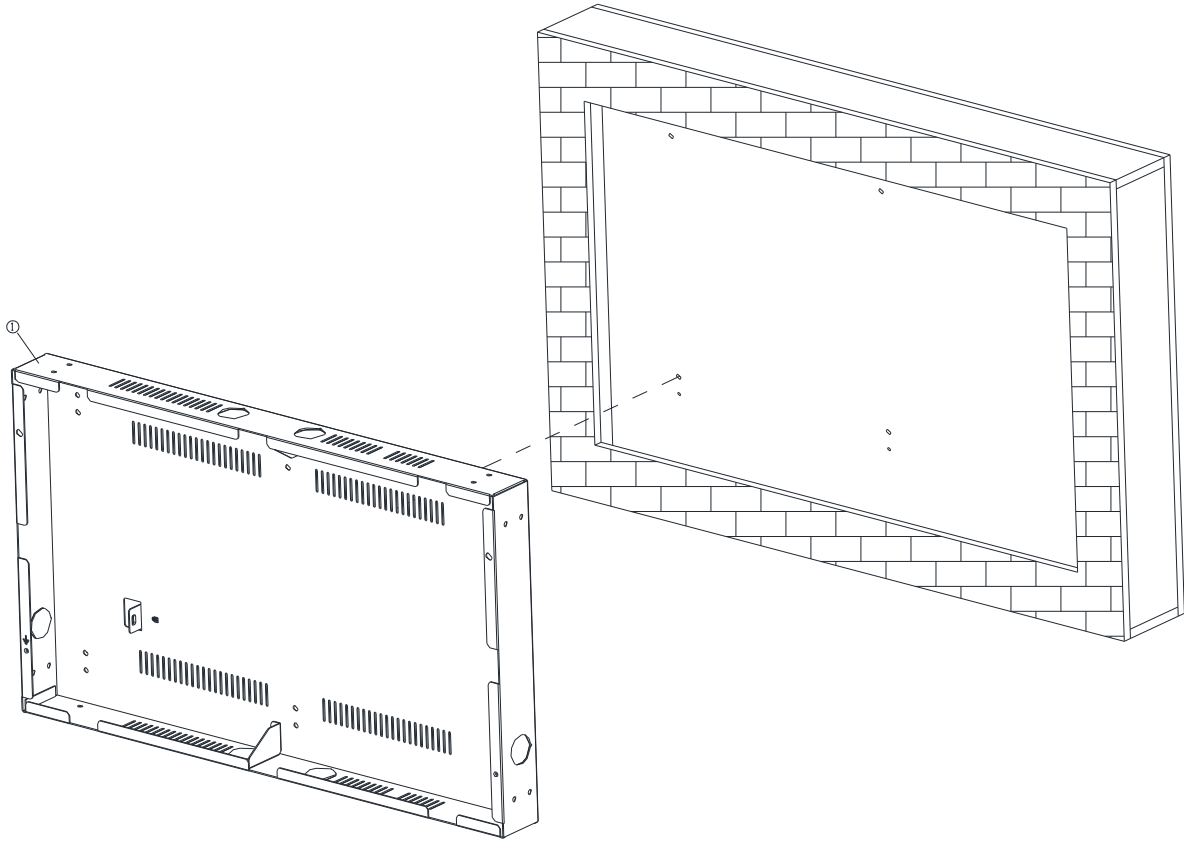

Step1. Install the 21" Wall Box and fix it on the wall, and use suitable screws to lock the wall box (the screws can be purchased according to actual needs)

| | | |
|------|-----------|----------|
| 1 | Wall box | 1 |
| Item | Part Name | Quantity |

OFP-21W33

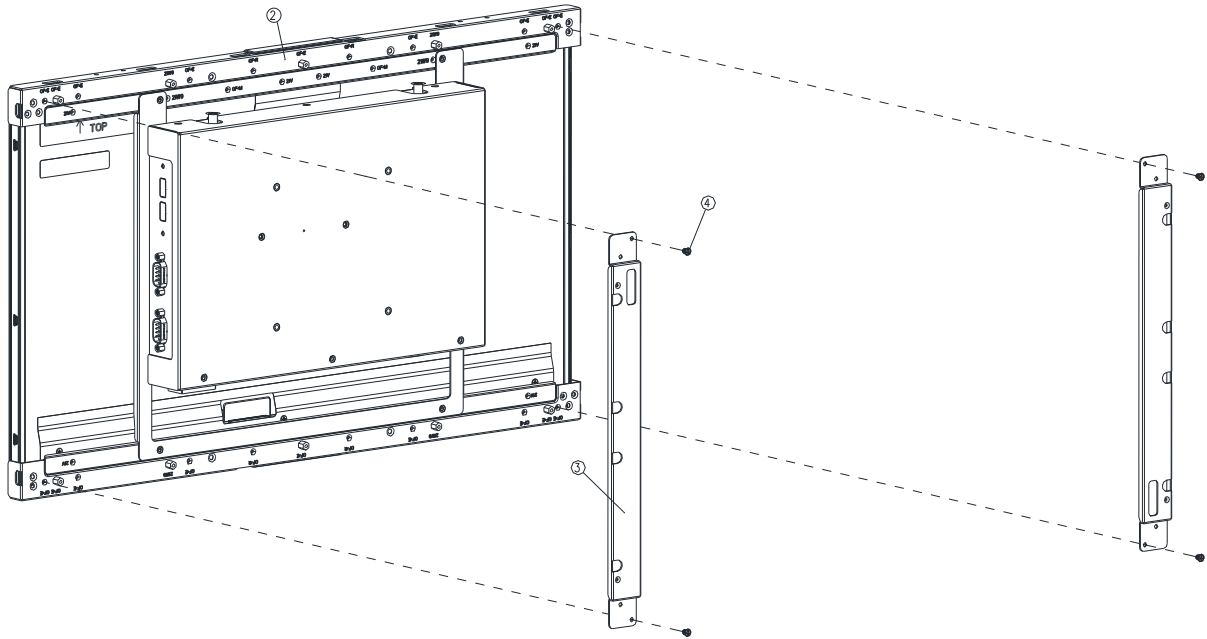

Step2. Assemble the 2pcs Bracket-RL on the left and right sides of the OFP-21W33 bracket by fastening 4 pcs screws on each side

| | | |
|------|------------|----------|
| 4 | Screw | 4 |
| 3 | Bracket-RL | 2 |
| 2 | OFP-21W33 | 1 |
| Item | Part Name | Quantity |

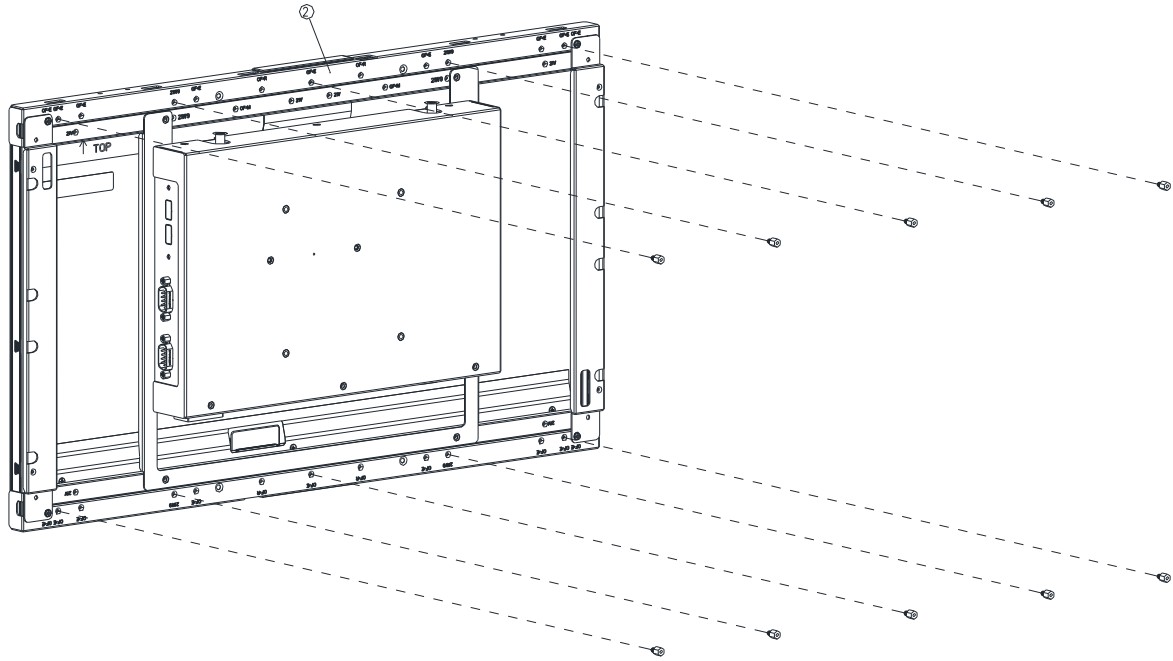

Step3. Fasten 10 pcs Hexagon Studs on each side of the OFP-21W33 Bracket.

| | | |
|------|----------------|----------|
| 5 | Hexagon Stud | 10 |
| 2 | BCX11_156_ASSY | 1 |
| Item | Part Name | Quantity |

OFP-21W33

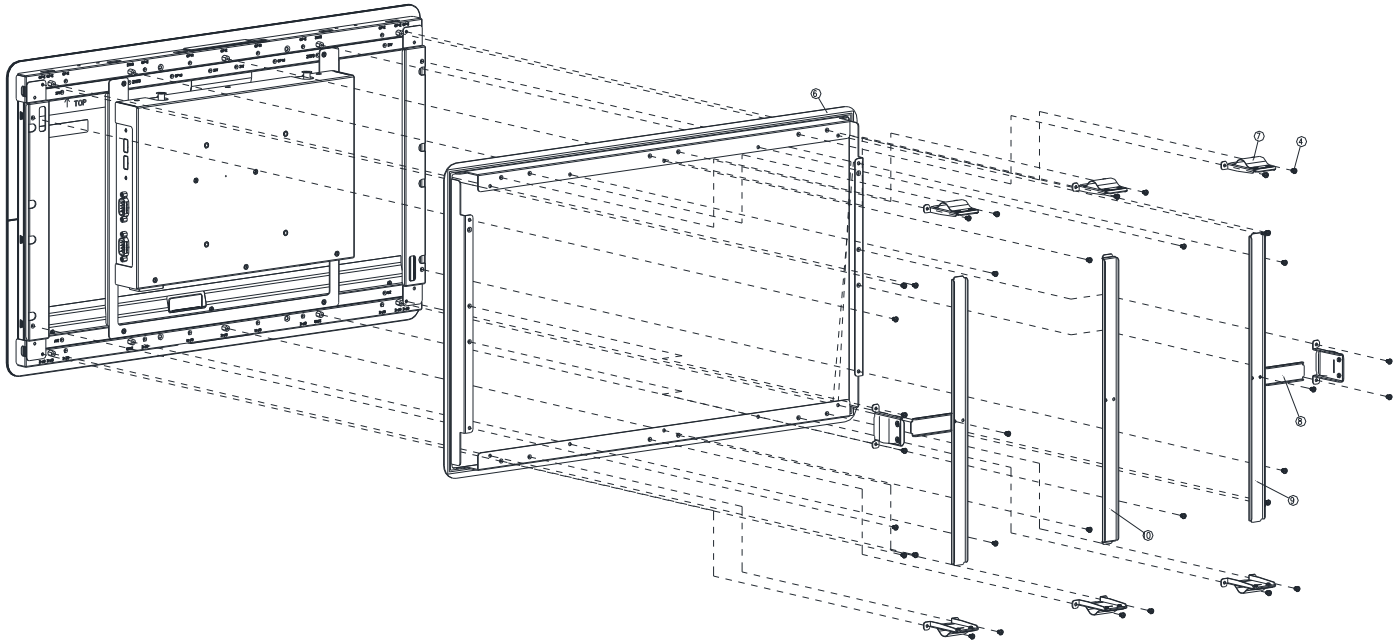

Step4-1. Assemble the Front bracket to OFP-21W33, and fasten 14 pcs screws to the 10 corresponding Hexagon Studs locations and 4 Bracket R/L locations.

Step4-2. Fasten the 3 pcs wall mount kit to the top of the Front bracket with 6pcs screws

Step4-3. Fasten 2 pcs Support Bracket-H to 2 pcs Support Bracket-V with 2 pcs screws.

Step4-4. Insert the Support Bracket-H into the locked rectangular hole of the Wall mount kit, and insert the unlocked rectangular hole of the Wall mount kit into the Support Bracket-V/Support Bracket-M and fasten 2 pcs Screws on the Front bracket (3 times in this step)

Step4-5. Insert the rectangular hole of the Wall mount kit into the Support Bracket-H and fasten 2pcs screws to the Front bracket (Repeat two times)

| | | |
|------|-------------------|----------|
| 10 | Support Bracket-M | 1 |
| 9 | Support Bracket-V | 2 |
| 8 | Support Bracket-H | 2 |
| 7 | Wall mount kit | 8 |
| 4 | Screw | 32 |
| 6 | Front bracket | 1 |
| Item | Part Name | Quantity |





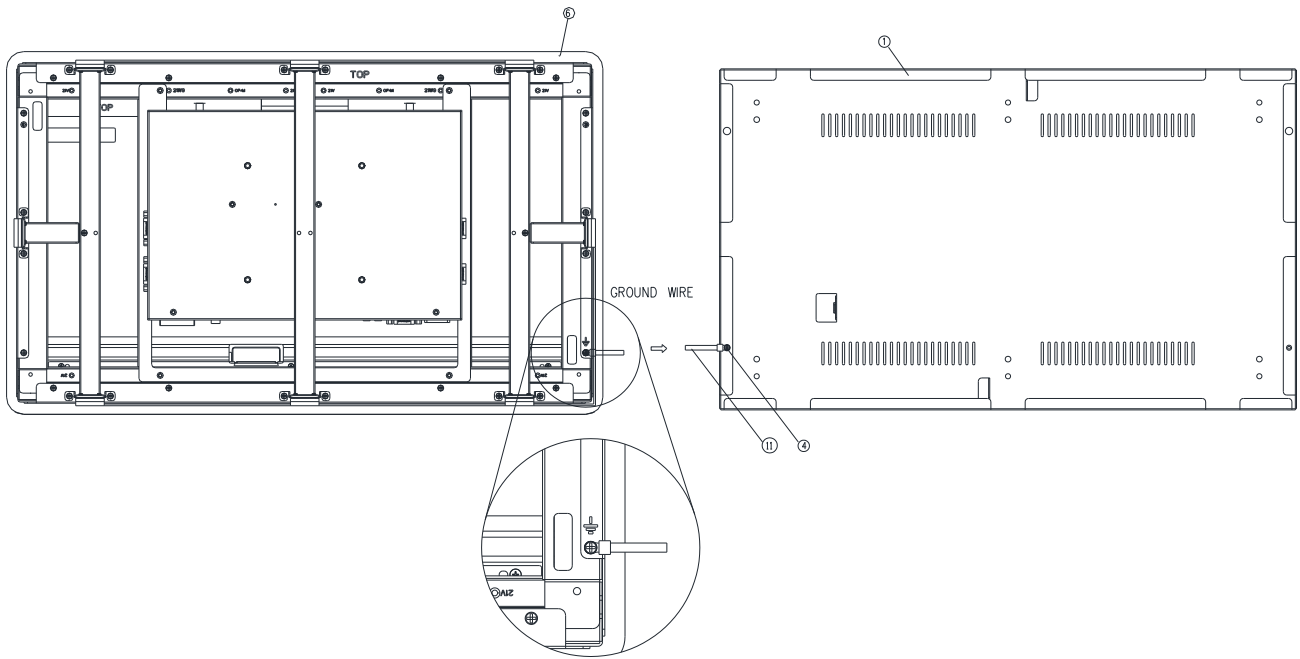

Step5. Fasten the Ground wire with 2 screws on the ground screw holes of Front bracket and Wall box.

| | | |
|------|---------------|----------|
| 11 | Ground wire | 1 |
| 4 | Screw | 2 |
| 6 | Front bracket | 1 |
| 1 | Wall box | 1 |
| Item | Part Name | Quantity |

OFP-21W33

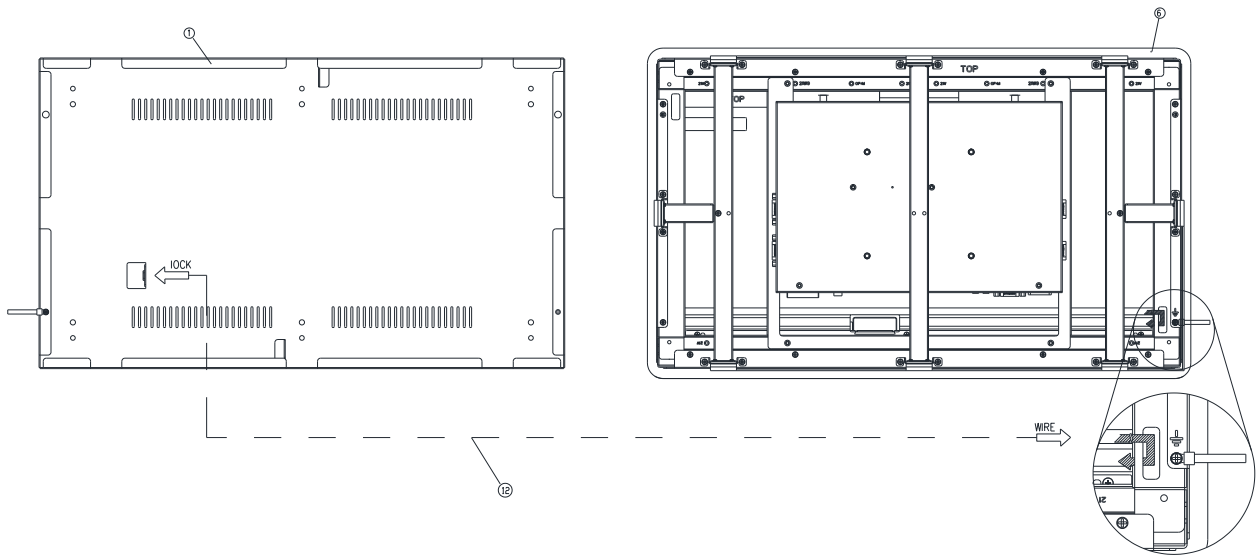

Step6. Wrap the Kensington lock (option) around the hole in the Front bracket and attach the lock to the keyhole in the Wall box.

| | | |
|------|-----------------|----------|
| 12 | Kensington lock | 1 |
| 6 | Front bracket | 1 |
| 1 | Wall box | 1 |
| Item | Part Name | Quantity |

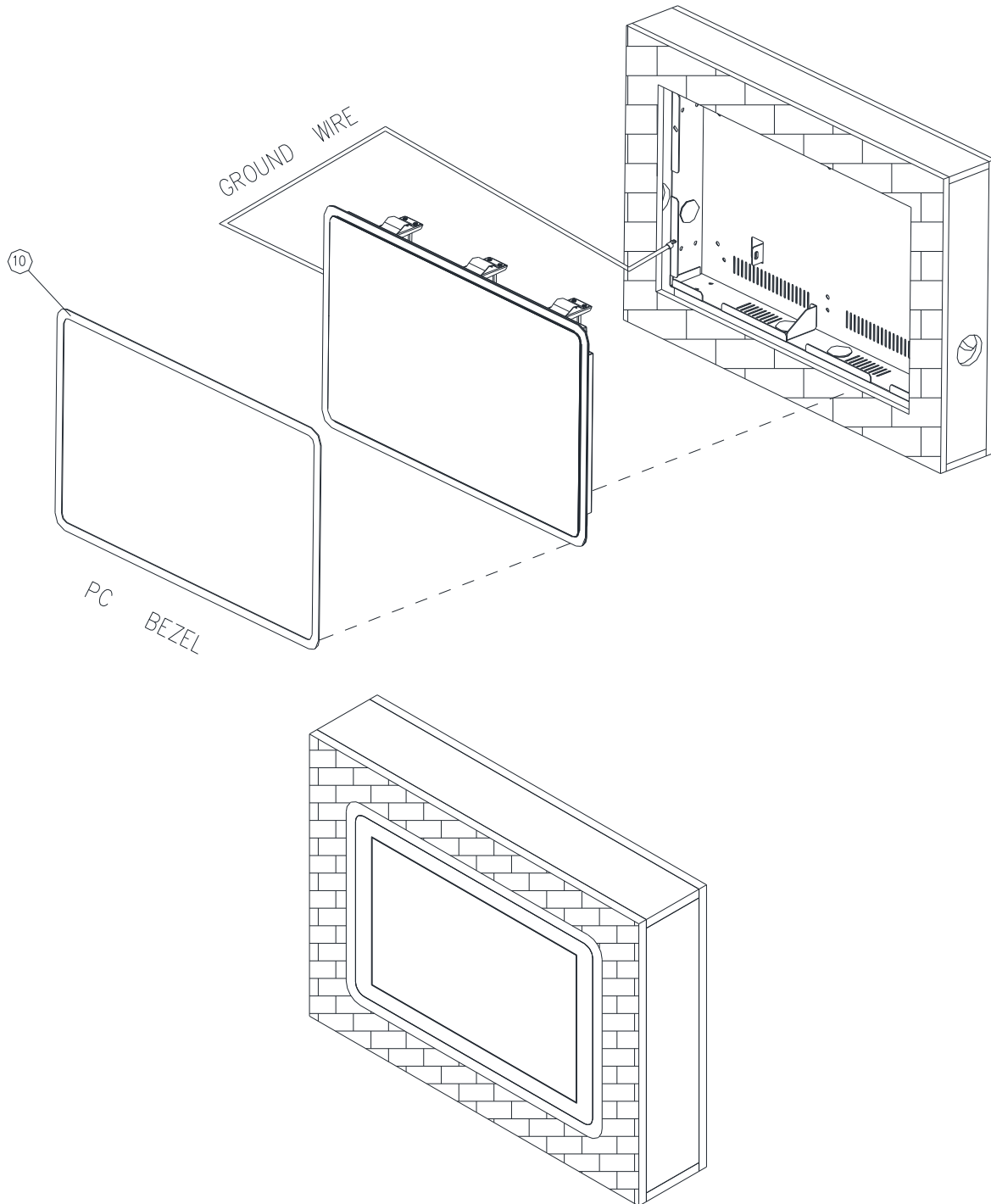

Step6-1. Store the Ground wire and Kensington lock in the Wall box and embed the OFP-21W33 semi-finished product into the wall (Wall Box).

Step6-2. Paste the Decoration Plate on the Front bracket to complete installation.

| | | |
|------|-----------|----------|
| 10 | PC bezel | 1 |
| Item | Part Name | Quantity |



2. Hardware Configuration

For advanced information, please refer to:

- 1- EMX-APLP included in this manual.



Note: If you need more information, please visit our website:

<http://www.avalue.com.tw>

2.1 OFP-21W33 connector mapping

2.1.1 Serial Port connector (COM)

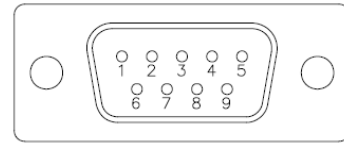
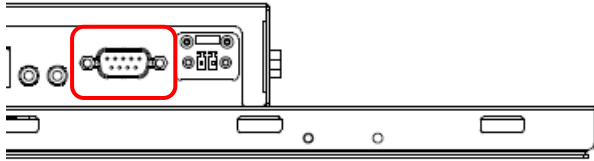

In RS-232 Mode

| Signal | PIN | PIN | Signal |
|--------|-----|-----|--------|
| NDCD# | 1 | 6 | NDSR# |
| NRXD | 2 | 7 | NRTS# |
| NTXD | 3 | 8 | NCTS# |
| NDTR# | 4 | 9 | NRI# |
| GND | 5 | | |

In RS-422 Mode

| Signal | PIN | PIN | Signal |
|--------|-----|-----|--------|
| TxD1- | 1 | 6 | NC |
| TxD1+ | 2 | 7 | NC |
| RxD1+ | 3 | 8 | NC |
| RxD1- | 4 | 9 | NC |
| GND | 5 | | |

In RS-485 Mode

| Signal | PIN | PIN | Signal |
|--------|-----|-----|--------|
| DATA1- | 1 | 6 | NC |
| DATA1+ | 2 | 7 | NC |
| NC | 3 | 8 | NC |
| NC | 4 | 9 | NC |
| GND | 5 | | |

2.1.2 DC power-in connector (DC in)

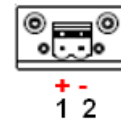
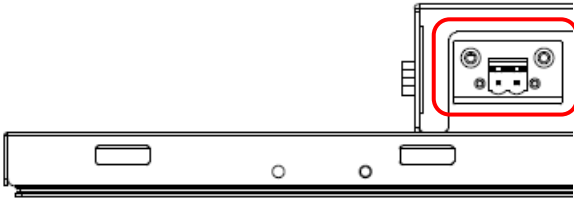

| Signal | PIN |
|--------------|-----|
| +V12-24_DCIN | 1 |
| GND | 2 |

2.2 Product Overview

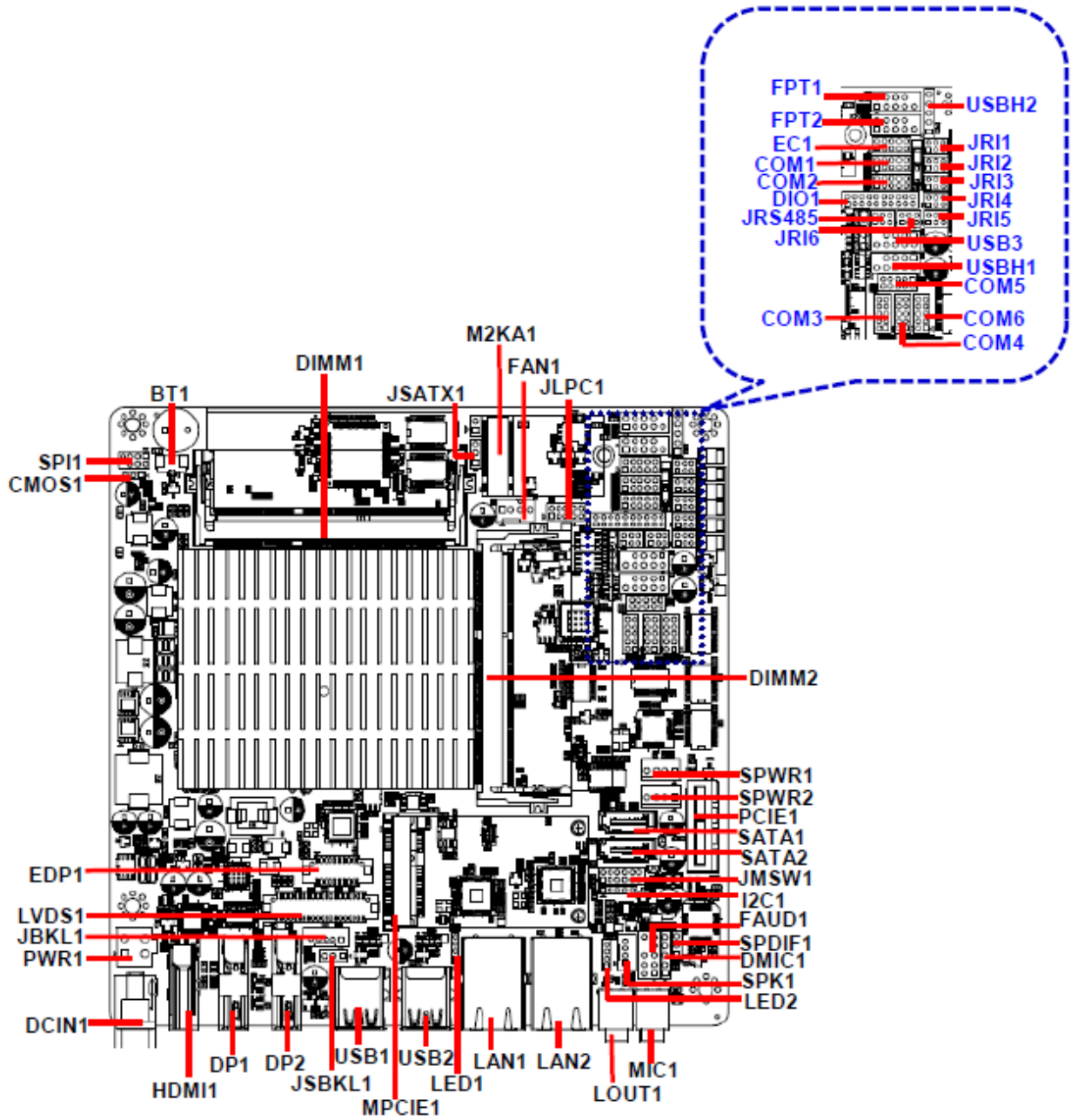

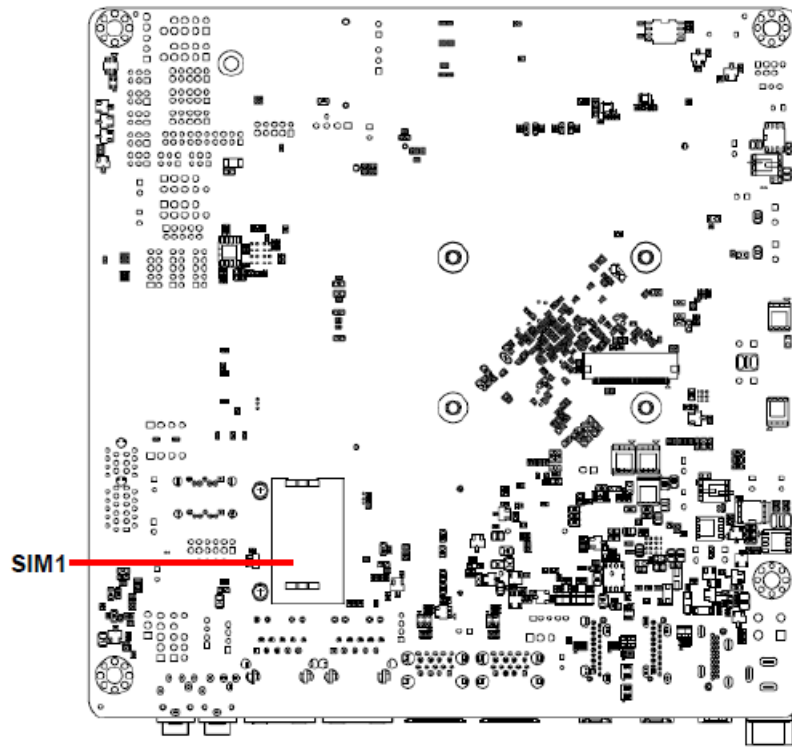

2.3 Jumper and Connector List

You can configure your board to match the needs of your application by setting jumpers. A jumper is the simplest kind of electric switch.

It consists of two metal pins and a small metal clip (often protected by a plastic cover) that slides over the pins to connect them. To “close” a jumper you connect the pins with the clip. To “open” a jumper you remove the clip. Sometimes a jumper will have three pins, labeled 1, 2, and 3. In this case, you would connect either two pins.

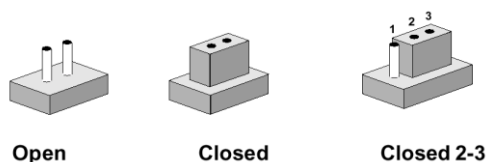

The jumper settings are schematically depicted in this manual as follows:



A pair of needle-nose pliers may be helpful when working with jumpers.

Connectors on the board are linked to external devices such as hard disk drives, a keyboard, or floppy drives. In addition, the board has a number of jumpers that allow you to configure your system to suit your application.

If you have any doubts about the best hardware configuration for your application, contact your local distributor or sales representative before you make any changes.

The following tables list the function of each of the board’s jumpers and connectors.

Jumpers

| Label | Function | Note |
|-----------------------|--|----------------------------|
| JRI1/2/3/4/5/6 | Serial port 1/2/3/4/5/6 pin9 signal select | 3 x 2 header, pitch 2.00mm |
| JMSW1 | SATA2/MSATA1 mPCIe slot selector | 6 x 2 header, pitch 2.00mm |
| JSBKL1 | LVDS Back Light power selection | 3 x 1 header, pitch 2.54mm |
| JSATX1 | AT/ATX Power Mode Select | 3 x 1 header, pitch 2.54mm |
| CMOS1 | Clear CMOS | 3 x 1 header, pitch 2.00mm |

Connectors

| Label | Function | Note |
|-------------|-------------------------|----------------------------|
| FAN1 | CPU fan connector | 4 x 1 wafer, pitch 2.54mm |
| FPT1 | Front Panel connector 1 | 5 x 2 header, pitch 2.54mm |
| FPT2 | Front Panel connector 2 | 5 x 2 header, pitch 2.54mm |

Quick Reference Guide

| | | |
|----------------|--|---|
| DIMM1/2 | 204-pin DDR3L DIMM socket | |
| FAUD1 | Front Audio connector | 5 x 2 header, pitch 2.54mm |
| JBKL1 | LCD Inverter connector | 5 x 1 wafer, pitch 2.00mm Compatible with Connector: JST PHR-5 |
| SPI1 | SPI connector | 4 x 2 header, pitch 2.00mm |
| COM1 | Serial Port 1 connector | 5 x 2 header, pitch 2.00mm |
| COM2 | Serial Port 2 connector | 5 x 2 header, pitch 2.00mm |
| COM3 | Serial Port 3 connector | 5 x 2 header, pitch 2.00mm |
| COM4 | Serial Port 4 connector | 5 x 2 header, pitch 2.00mm |
| COM5 | Serial Port 5 connector | 5 x 2 header, pitch 2.00mm |
| COM6 | Serial Port 6 connector | 5 x 2 header, pitch 2.00mm |
| JRS485 | Serial Port 1 RS485/422 Mode connector | 3 x 2 header, pitch 2.00mm |
| DIO1 | General purpose I/O connector | 10 x 2 header, pitch 2.00mm |
| SPK1 | Speaker connector | 4 x 1 wafer, pitch 2.00mm |
| LVDS1 | LVDS Connector | DIN 40-pin wafer, pitch 1.25mm Compatible with Connector: Hirose DF13-40DS-1.25C |
| USB1/2 | USB connector 1/2 | |
| USB3 | USB 2.0 connector | 5 x 2 header, pitch 2.54mm |
| USBH1 | USB 2.0 connector | 5 x 2 header, pitch 2.54mm |
| USBH2 | USB 2.0 connector | 5 x 1 header, pitch 2.54mm |
| SPDIF1 | Sony/Philips Digital Interface | 3 x 1 header, pitch 2.54mm |
| LAN1/2 | RJ-45 Ethernet 1/2 | |
| PCIE1 | PCIe connector | |
| LED1 | LED indicator connector 1 | 4 x 1 header, pitch 2.00mm |
| LED2 | LED indicator connector 2 | 4 x 1 header, pitch 2.00mm |
| DP1/2 | DP connector 1/2 | |
| EDP1 | eDP connector | 10 x 2 wafer, pitch 1.25mm |
| BT1 | Battery connector | 2 x 1 wafer, pitch 1.25mm |
| M2KA1 | M.2 Type A 2230 connector | |
| MPCIE1 | Mini-PCIe connector 1 | |
| JLPC1 | LPC connector | 5 x 2 header, pitch 2.00mm |
| PWR1 | Power connector | 2 x 2 wafer, pitch 4.20mm |
| SATA1/2 | Serial ATA connector 1/2 | |
| SPWR1/2 | SATA Power connector 1/2 | 4 x 1 wafer, pitch 2.54mm |

OFP-21W33

| | | |
|--------------|------------------------------|----------------------------|
| EC1 | EC_Program | 5 x 2 header, pitch 2.00mm |
| DCIN1 | DC Power-in connector | |
| I2C1 | I2C connector | 5 x 1 header, pitch 2.00mm |
| HDMI1 | HDMI connector | |
| LOUT1 | Line-out audio jack | |
| MIC1 | Mic-in audio jack | |
| DMIC1 | Digital Microphone connector | 5 x 1 header, pitch 2.54mm |
| SIM1 | SIM card slot | |

2.4 Setting Jumpers & Connectors

2.4.1 Serial port 1/2/3/4/5/6 pin9 signal select (JR11/JR12/JR13/JR14/JR15/JR16)

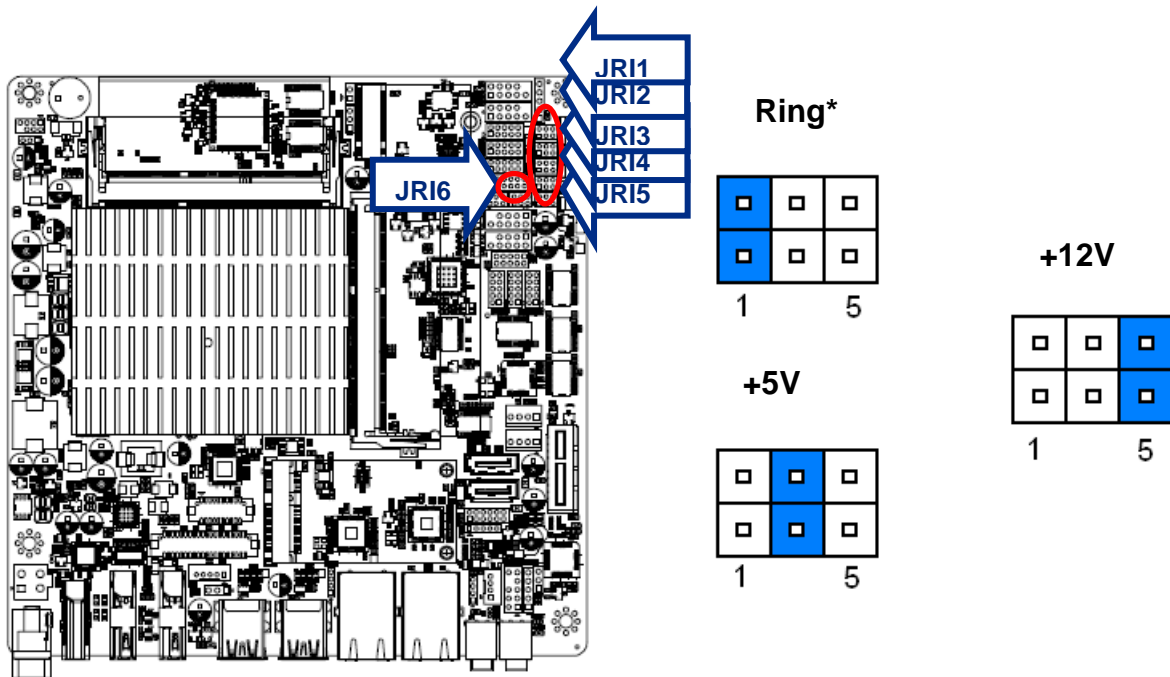

* Default

2.4.2 SATA2/MSATA1 mPCIe slot selector (JMSW1)

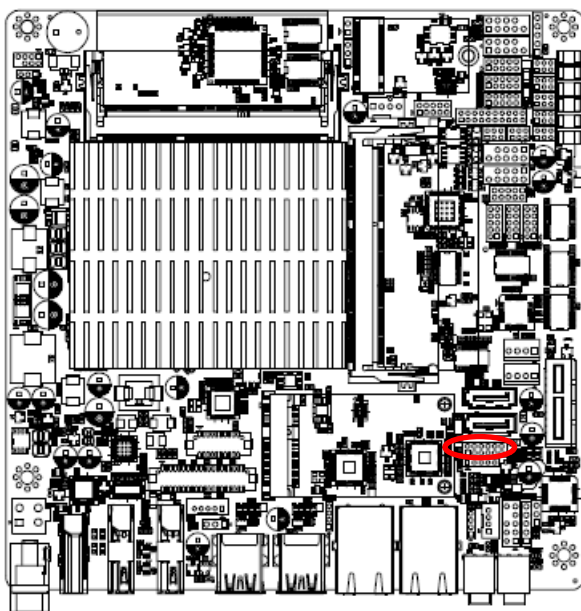

SATA2 Connector*
(SATA2 Connector enabled, MSATA1 slot Disabled)

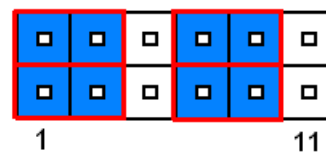

MSATA1 mPCIe slot
(MSATA1 slot enabled, SATA2 Connector Disabled)

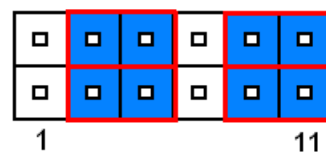

* Default

Note:

SATA2/MSATA1 shared SATA signal, can not be used simultaneously.

2.4.3 LVDS Back Light power selection (JSBKL1)

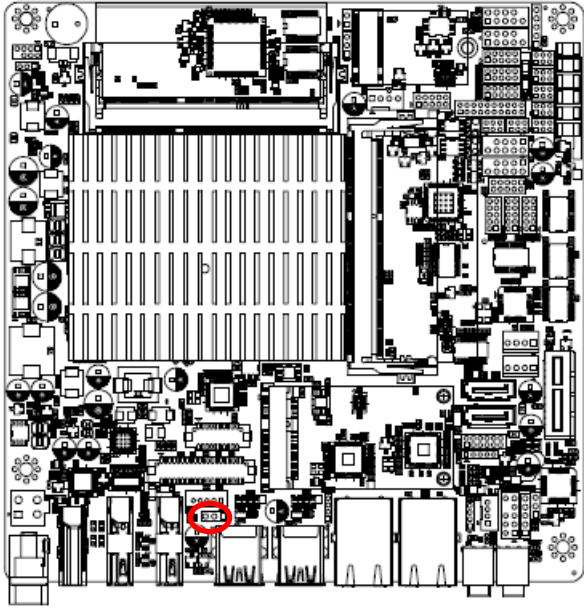

PWM Mode*(Max current: 2A)

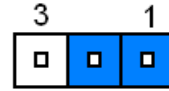

DC Mode(Max current: 2A)



* Default

2.4.4 AT/ATX Power Mode Select (JSATX1)

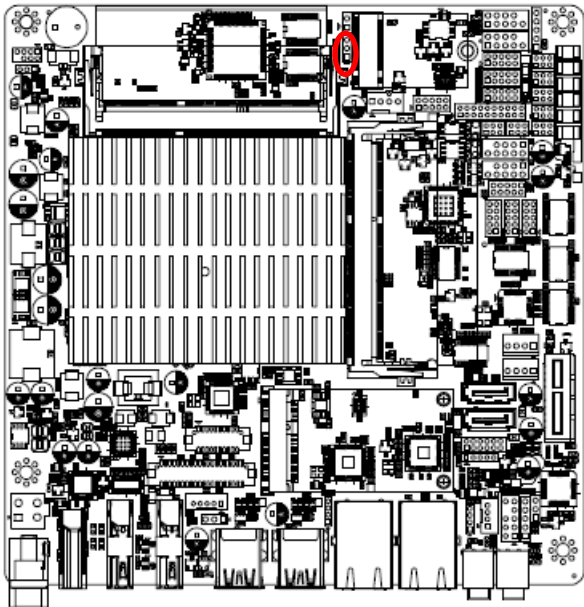

ATX*

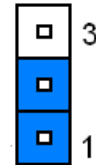

AT

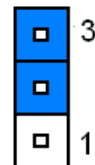

* Default

2.4.5 Clear CMOS (CMOS1)

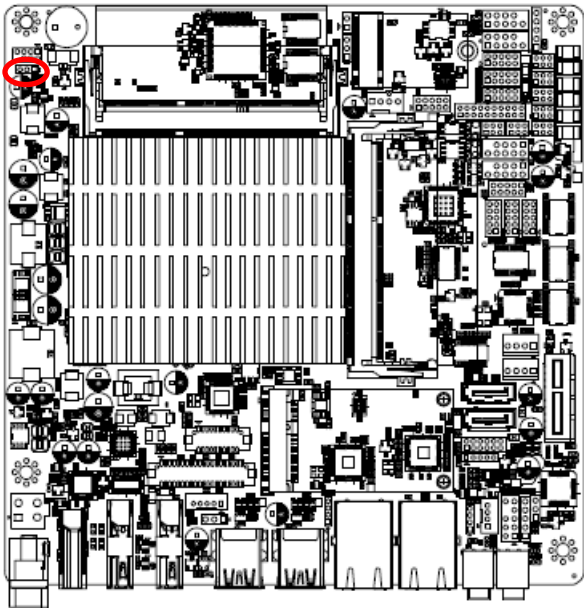

Protect*

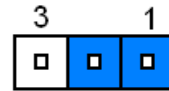

Clear CMOS



* Default

2.4.6 LCD Inverter connector (JBKL1)

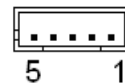
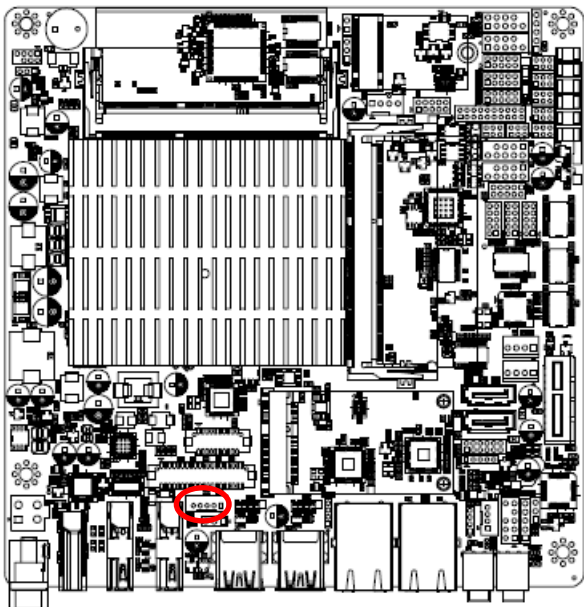

| PIN | Signal |
|-----|-------------|
| 1 | +12V |
| 2 | GND |
| 3 | LVDS_BKLTEN |
| 4 | LVDS_BKLADJ |
| 5 | +5V |

2.4.7 Serial port 1/2 connector (COM1/2)

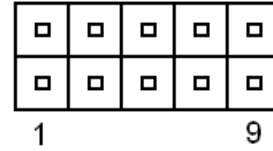
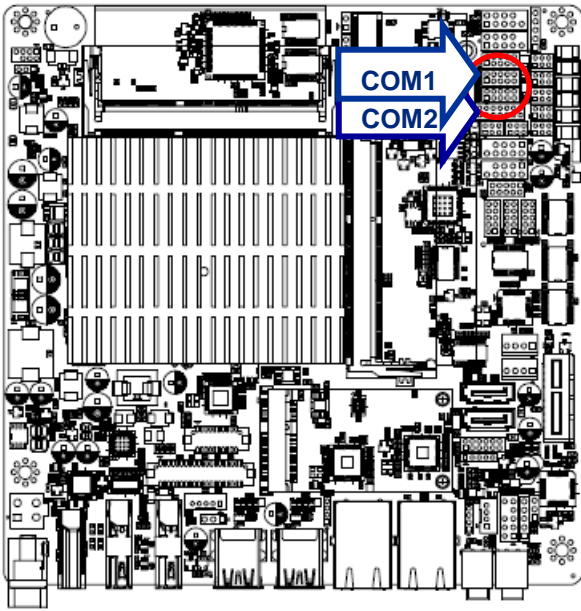

| Signal | PIN | PIN | Signal |
|--------|-----|-----|--------|
| DCD | 1 | 2 | RXD |
| TXD | 3 | 4 | DTR |
| GND | 5 | 6 | DSR |
| RTS | 7 | 8 | CTS |
| RI | 9 | 10 | NC |

2.4.8 Serial port 3/4/6 connector (COM3/4/6)

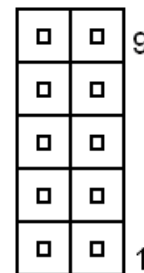
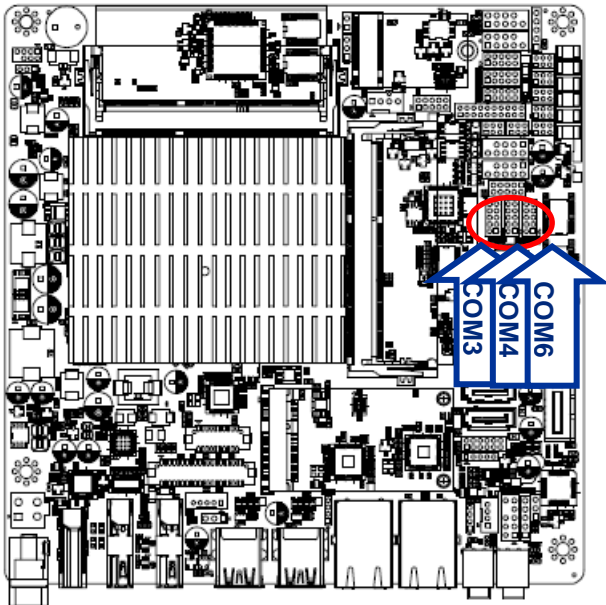

| Signal | PIN | PIN | Signal |
|--------|-----|-----|--------|
| NC | 10 | 9 | RI |
| CTS | 8 | 7 | RTS |
| DSR | 6 | 5 | GND |
| DTR | 4 | 3 | TXD |
| RXD | 2 | 1 | DCD |

2.4.9 Serial port 5 connector (COM5)

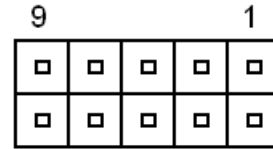
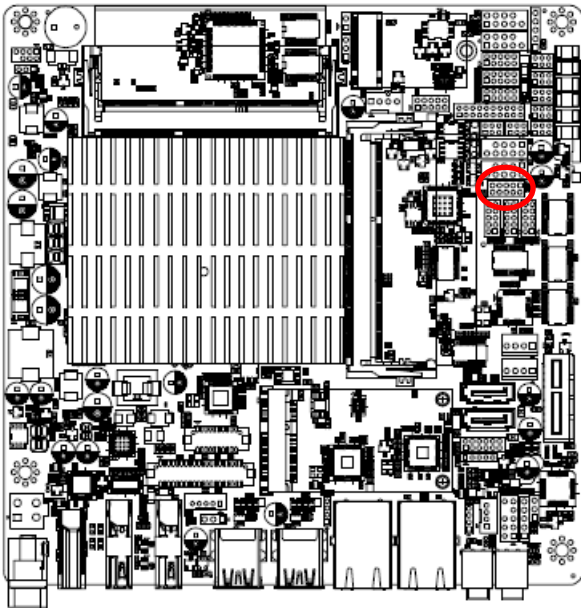

| Signal | PIN | PIN | Signal |
|--------|-----|-----|--------|
| NDCD# | 1 | 2 | NRXD |
| NTXD | 3 | 4 | NDTR# |
| GND | 5 | 6 | NDSR# |
| NRTS# | 7 | 8 | NCTS# |
| NRI# | 9 | 10 | NC |

2.4.10 Serial Port 1 RS485/422 Mode connector (JRS485)

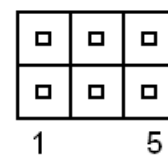
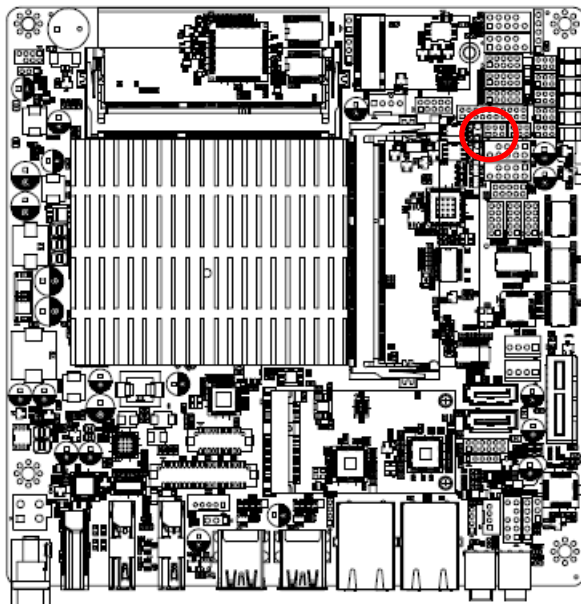

| Signal | PIN | PIN | Signal |
|--------|-----|-----|--------|
| 485TX- | 1 | 2 | 422RX- |
| 485TX+ | 3 | 4 | 422RX+ |
| GND | 5 | 6 | GND |

2.4.11 General purpose I/O connector (DIO1)

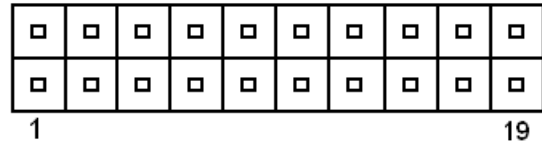
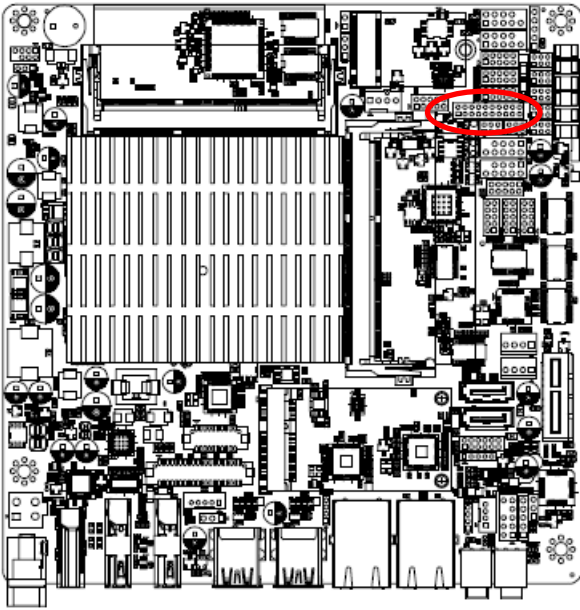

| Signal | PIN | PIN | Signal |
|---------|-----|-----|----------|
| DI0 | 1 | 2 | DO0 |
| DI1 | 3 | 4 | DO1 |
| DI2 | 5 | 6 | DO2 |
| DI3 | 7 | 8 | DO3 |
| DI4 | 9 | 10 | DO4 |
| DI5 | 11 | 12 | DO5 |
| DI6 | 13 | 14 | DO6 |
| DI7 | 15 | 16 | DO7 |
| SMB_CLK | 17 | 18 | SMB_DATA |
| GND | 19 | 20 | +5V |

2.4.12 SATA Power connector 1/2 (SPWR1/2)

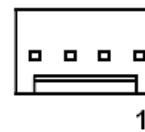
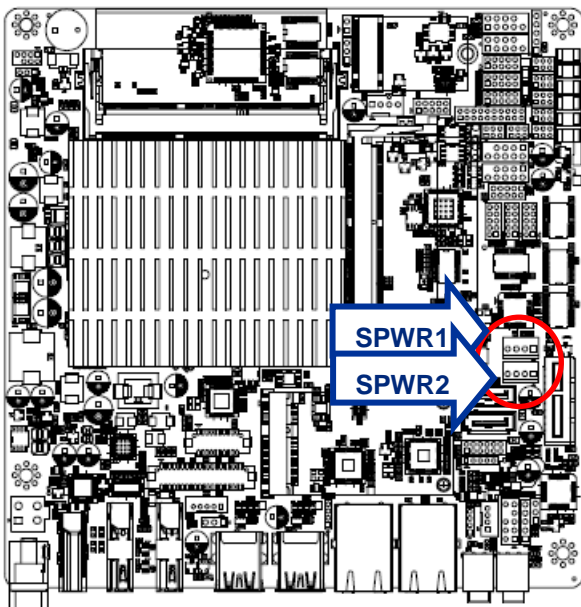

| PIN | Signal |
|-----|------------|
| 1 | +V5S_SATA |
| 2 | GND |
| 3 | GND |
| 4 | +V12S_SATA |

2.4.13 Power connector (PWR1)

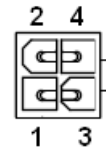
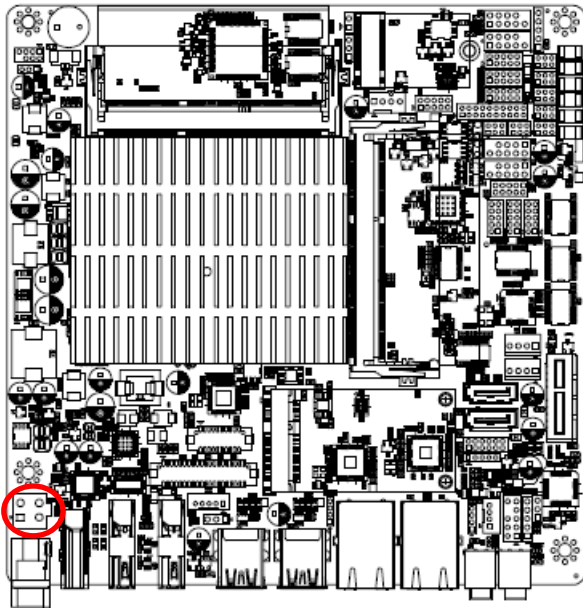

| Signal | PIN | PIN | Signal |
|--------------|-----|-----|--------------|
| GND | 1 | 2 | GND |
| +V12-24_DCIN | 3 | 4 | +V12-24_DCIN |

2.4.14 USB2.0 connector (USB3)

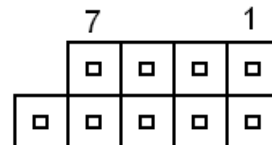
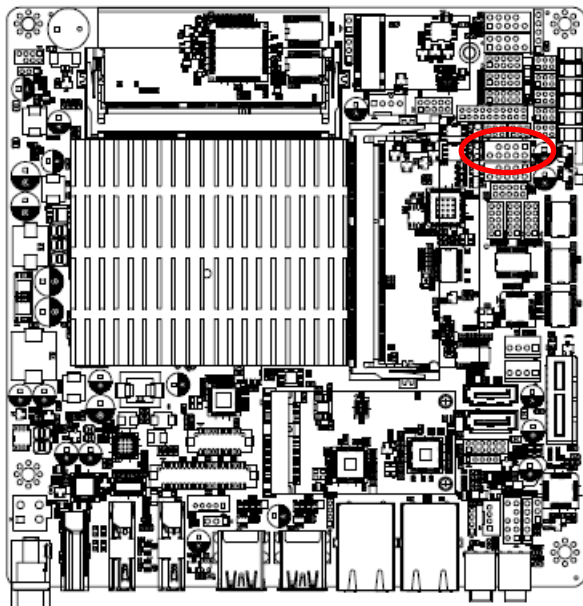

| Signal | PIN | PIN | Signal |
|--------|-----|-----|--------|
| +5VSB | 1 | 2 | +5VSB |
| USBDN4 | 3 | 4 | USBDN5 |
| USBDP4 | 5 | 6 | USBDP5 |
| GND | 7 | 8 | GND |
| | | 10 | NC |

2.4.15 USB2.0 connector (USBH1)

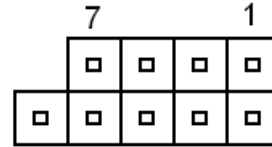
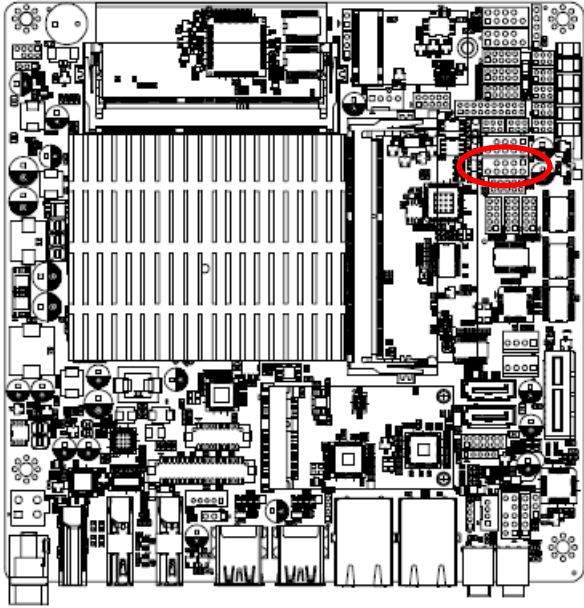

| Signal | PIN | PIN | Signal |
|----------|-----|-----|----------|
| +5VSB | 1 | 2 | +5VSB |
| USB_HDN1 | 3 | 4 | USB_HDN2 |
| USB_HDP1 | 5 | 6 | USB_HDP2 |
| GND | 7 | 8 | GND |
| | | 10 | NC |

2.4.16 USB2.0 connector (USBH2)

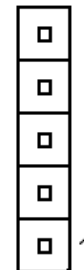
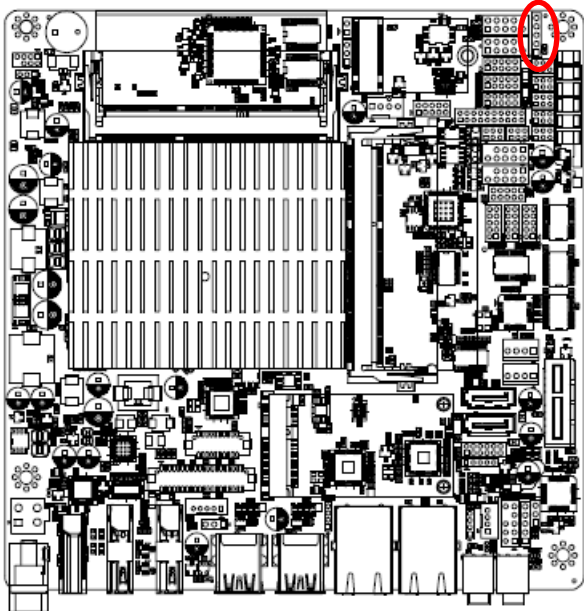

| PIN | Signal |
|-----|----------|
| 5 | NC |
| 4 | GND |
| 3 | USB_HDP4 |
| 2 | USB_HDN4 |
| 1 | +5VSB |

2.4.17 LVDS connector (LVDS1)

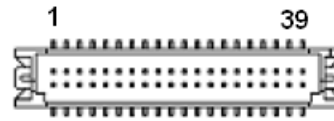
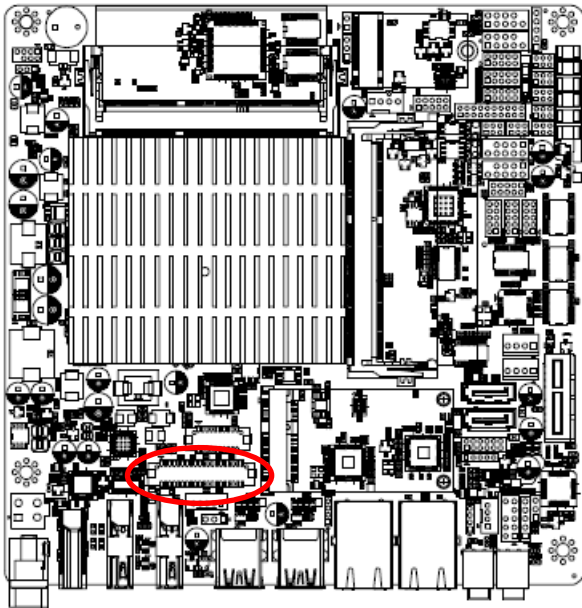

| Signal | PIN | PIN | Signal |
|-------------|-----|-----|-------------|
| +3.3V | 1 | 2 | +5V |
| +3.3V | 3 | 4 | +5V |
| NC | 5 | 6 | NC |
| GND | 7 | 8 | GND |
| LVDS_DATAP1 | 9 | 10 | LVDS_DATAP0 |
| LVDS_DATAN1 | 11 | 12 | LVDS_DATAN0 |
| GND | 13 | 14 | GND |
| LVDS_DATAP3 | 15 | 16 | LVDS_DATAP2 |
| LVDS_DATAN3 | 17 | 18 | LVDS_DATAN2 |
| GND | 19 | 20 | GND |
| LVDS_DATAP5 | 21 | 22 | LVDS_DATAP4 |
| LVDS_DATAN5 | 23 | 24 | LVDS_DATAN4 |
| GND | 25 | 26 | GND |
| LVDS_DATAP7 | 27 | 28 | LVDS_DATAP6 |
| LVDS_DATAN7 | 29 | 30 | LVDS_DATAN6 |
| GND | 31 | 32 | GND |
| LVDS_CLK2P | 33 | 34 | LVDS_CLK1P |
| LVDS_CLK2N | 35 | 36 | LVDS_CLK1N |
| GND | 37 | 38 | GND |
| +12V | 39 | 40 | +12V |

2.4.18 Battery connector (BT1)

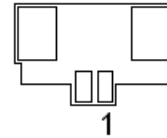
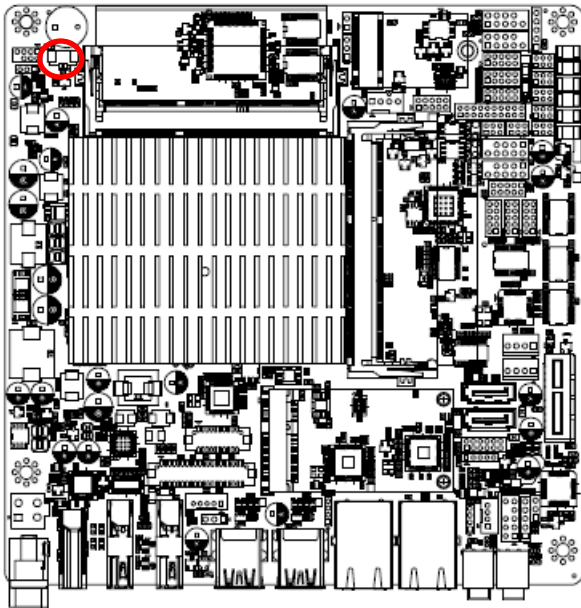

| PIN | Signal |
|-----|---------|
| 1 | +3.3VSB |
| 2 | GND |

2.4.19 Front Audio connector (FAUD1)

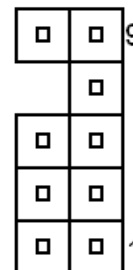
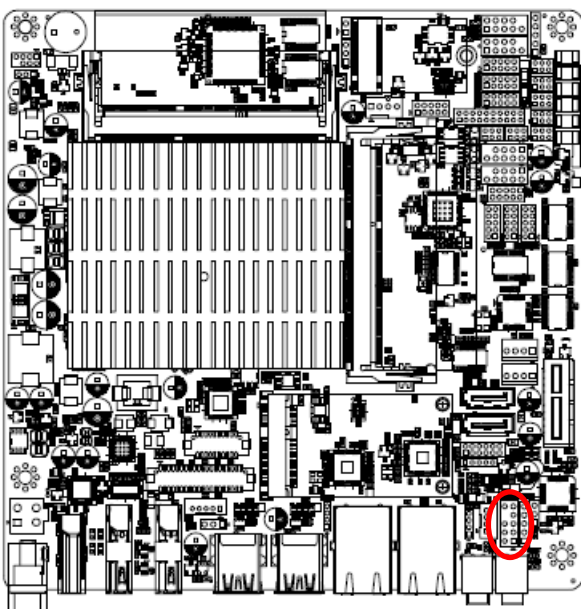

| Signal | PIN | PIN | Signal |
|---------------|-----|-----|---------|
| LINE2_JD | 10 | 9 | LINE2_L |
| | | 7 | SENSE_B |
| MIC2_JD | 6 | 5 | LINE2_R |
| AUD_FRONT_DET | 4 | 3 | MIC2_R |
| GND | 2 | 1 | MIC2_L |

2.3.19.1 Signal Description –Front Audio connector (FAUD1)

| Signal | Signal Description |
|----------|----------------------------------|
| LINE2_JD | AUDIO IN (LINE_RIN/LIN)sense pin |
| MIC2_JD | MIC IN (MIC_RIN/LIN) sense pin |

2.4.20 LPC connector (JLPC1)

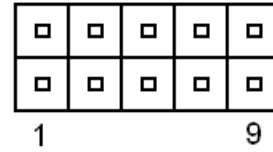
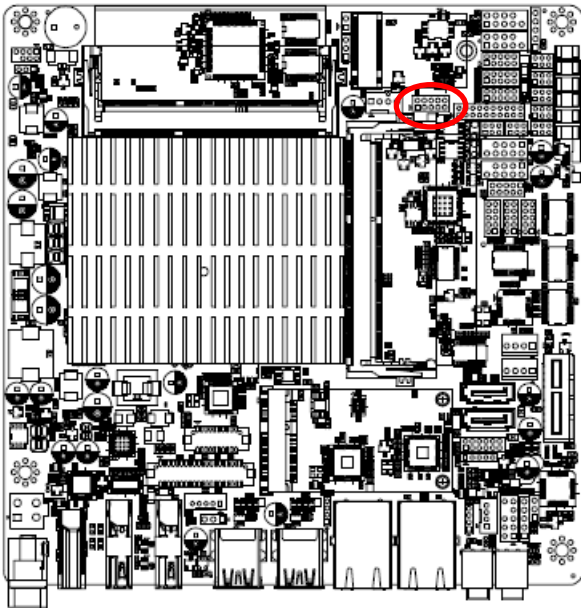

| Signal | PIN | PIN | Signal |
|------------|-----|-----|-------------|
| LPC_AD0 | 1 | 2 | +3.3V |
| LPC_AD1 | 3 | 4 | PLT_RST# |
| LPC_AD2 | 5 | 6 | LPC_FRAME# |
| LPC_AD3 | 7 | 8 | LPC_CLK_DEB |
| LPC_SERIRQ | 9 | 10 | GND |

2.4.21 EC_Program (EC1)

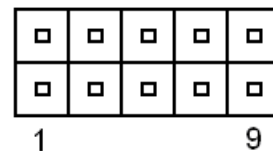
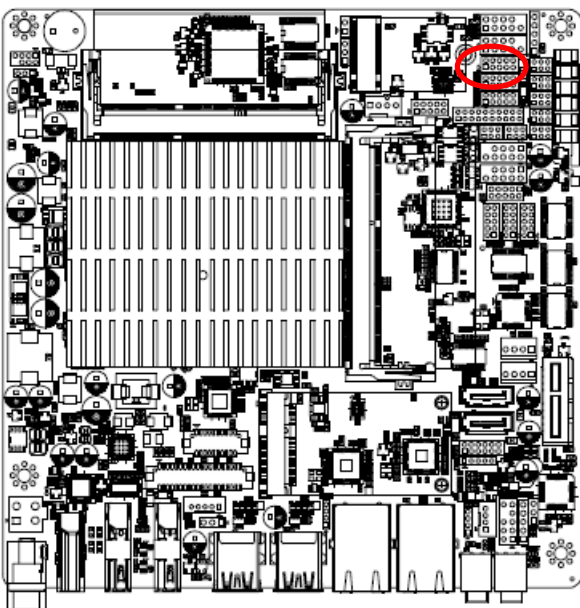

| Signal | PIN | PIN | Signal |
|-------------|-----|-----|------------|
| +3.3A_ECSPi | 1 | 2 | GND |
| EC_FSCE# | 3 | 4 | EC_FSCK |
| EC_FSMIOSO | 5 | 6 | EC_FSMOSI |
| EC_HOLD# | 7 | 8 | NC |
| EC_SMBCLK | 9 | 10 | EC_SMBDATA |

2.4.22 SPI connector (SPI1)

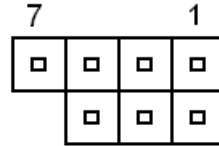
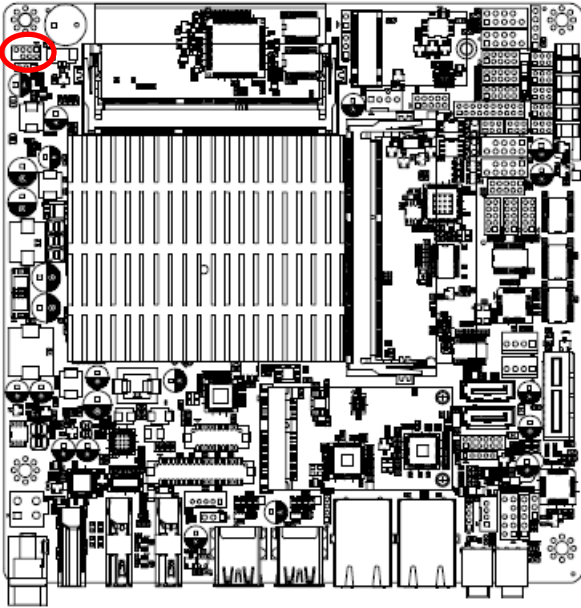

| Signal | PIN | PIN | Signal |
|-----------|-----|-----|----------|
| +1.8VSB | 1 | 2 | GND |
| SPI_CS0# | 3 | 4 | SPI_CLK |
| SPI_MISO | 5 | 6 | SPI_MOSI |
| SPI_HOLD# | 7 | | |

2.4.23 Sony/Philips Digital Interface (SPDIF1)

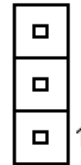
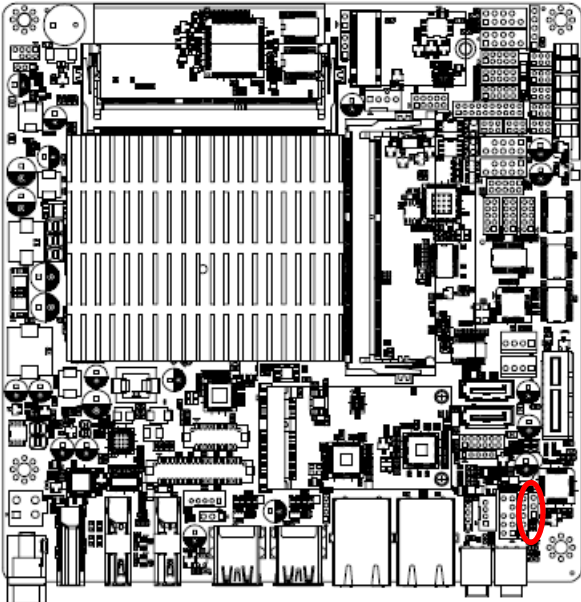

| PIN | Signal |
|-----|-----------|
| 3 | GND |
| 2 | SPDIF_OUT |
| 1 | +5V |

2.4.24 Speaker connector (SPK1)

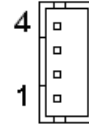
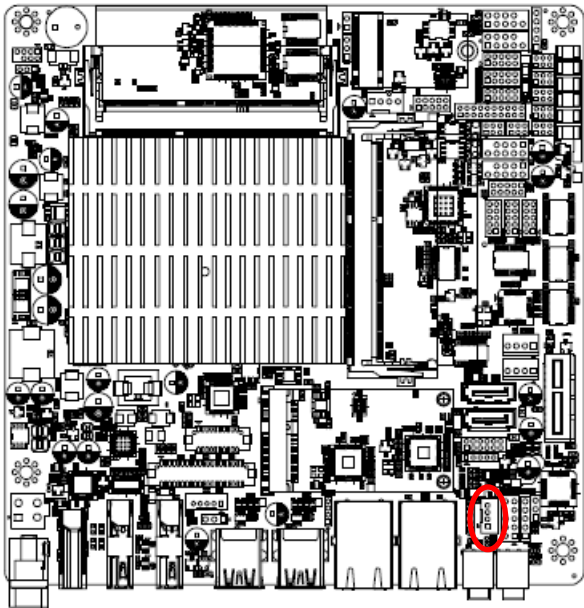

| PIN | Signal |
|-----|--------|
| 4 | RSPK- |
| 3 | RSPK+ |
| 2 | LSPK- |
| 1 | LSPK+ |

2.4.25 Front Panel connector 1 (FPT1)

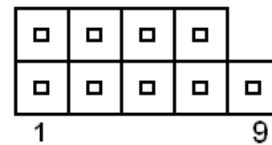
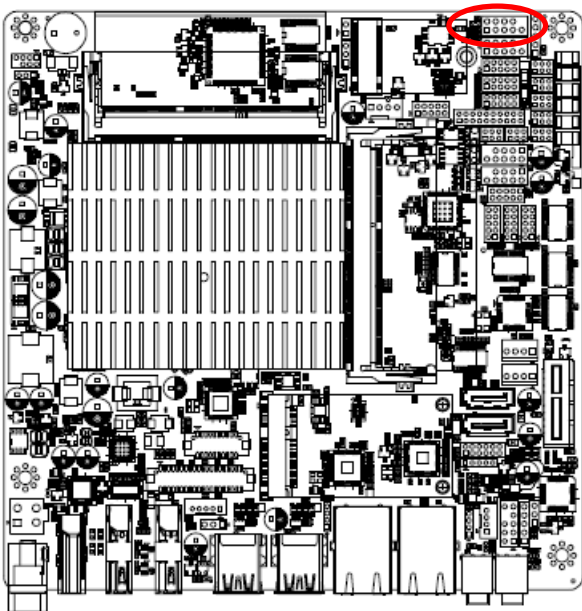

| Signal | PIN | PIN | Signal |
|---------|-----|-----|----------|
| +HD_LED | 1 | 2 | +PWR_LED |
| -HD_LED | 3 | 4 | -PWE_LED |
| +Reset | 5 | 6 | +PWR_BNT |
| -Reset | 7 | 8 | -PWR_BNT |
| NC | 9 | | |

2.4.26 Front Panel connector 2 (FPT2)

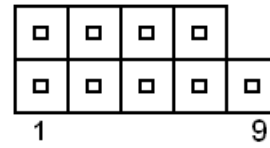
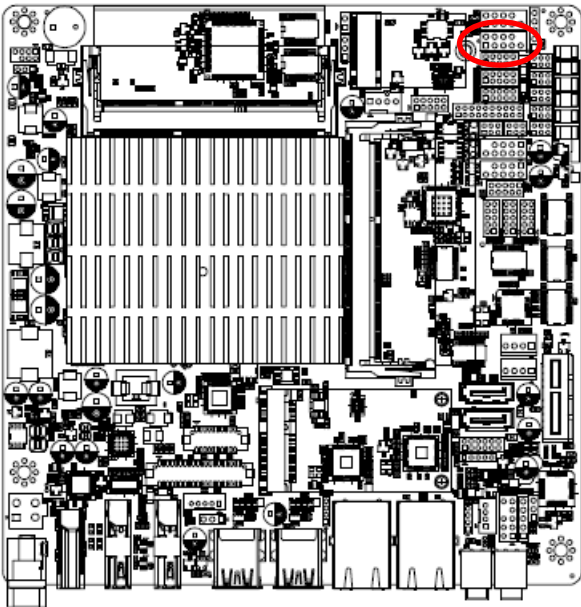

| Signal | PIN | PIN | Signal |
|----------|-----|-----|-------------|
| Speaker+ | 1 | 2 | BLK_VR(10K) |
| NC | 3 | 4 | BLK_UP |
| NC | 5 | 6 | BLK_DN |
| Speaker- | 7 | 8 | GND |
| NC | 9 | 10 | |

Note:

1. Pin2 with GND: Control LVDS Backlight by use Variable Resistor.
2. BLK_UP with GND/BLK_DN with GND: Step control LVDS Backlight by use button and BIOS must to be set "BR Button". (Please refer to page.61)

2.4.27 LED indicator connector 1 (LED1)

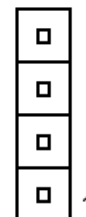
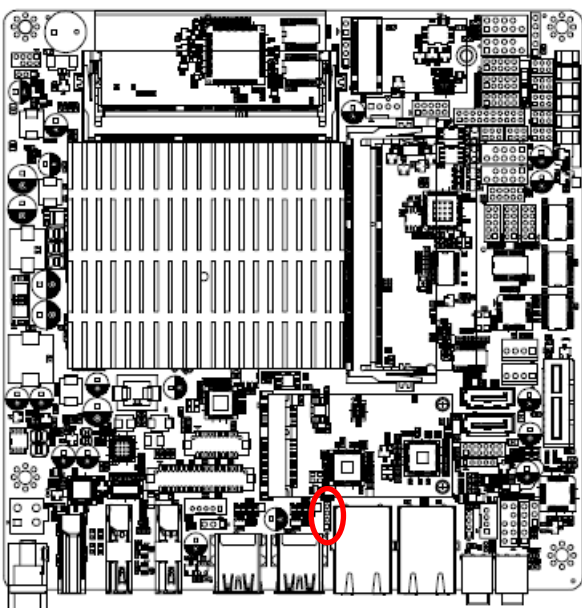

| PIN | Signal |
|-----|--------------|
| 4 | L1_1000#_LED |
| 3 | L1_100#_LED |
| 2 | L1_ACT_N |
| 1 | L1_ACT_P |

2.4.28 LED indicator connector 2 (LED2)

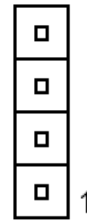
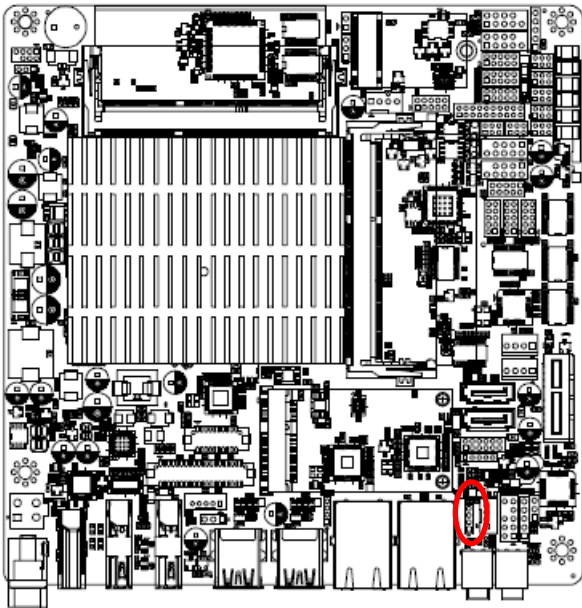

| PIN | Signal |
|-----|--------------|
| 4 | L2_1000#_LED |
| 3 | L2_100#_LED |
| 2 | L2_ACT_N |
| 1 | L2_ACT_P |

2.4.29 CPU fan connector (FAN1)

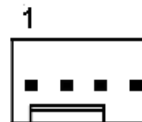
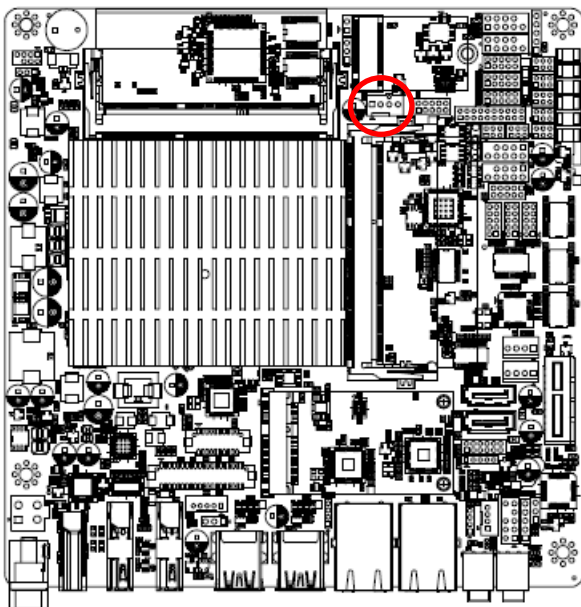

| PIN | Signal |
|-----|------------|
| 1 | GND |
| 2 | +12V |
| 3 | CPU_FANIN |
| 4 | CPU_FANOUT |

2.4.30 Digital Microphone connector (DMIC1)

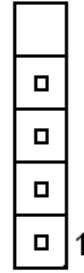
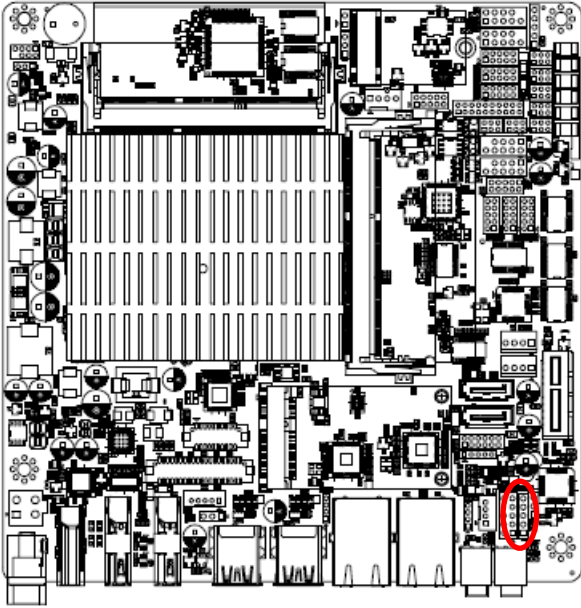

| PIN | Signal |
|-----|----------|
| 5 | |
| 4 | DMIC_CLK |
| 3 | GND |
| 2 | DMIC_DAT |
| 1 | +3.3VSB |

2.4.31 eDP connector (EDP1)

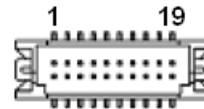
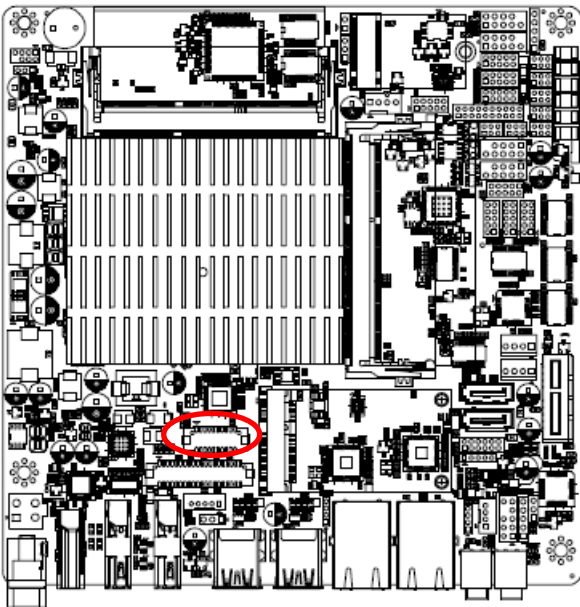

| Signal | PIN | PIN | Signal |
|-------------|-----|-----|-------------|
| GND | 1 | 2 | GND |
| EDP_TXN0 | 3 | 4 | EDP_TXN3 |
| EDP_TXP0 | 5 | 6 | EDP_TXP3 |
| GND | 7 | 8 | NC |
| EDP_TXN1 | 9 | 10 | GND |
| EDP_TXP1 | 11 | 12 | EDP_AUXN |
| GND | 13 | 14 | EDP_AUXP |
| EDP_TXN2 | 15 | 16 | GND |
| EDP_TXP2 | 17 | 18 | EDP_C_HPDP |
| EDP_VCC_PAL | 19 | 20 | EDP_VCC_PAL |

2.4.32 I2C connector (I2C1)

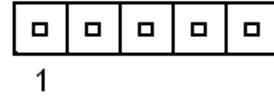
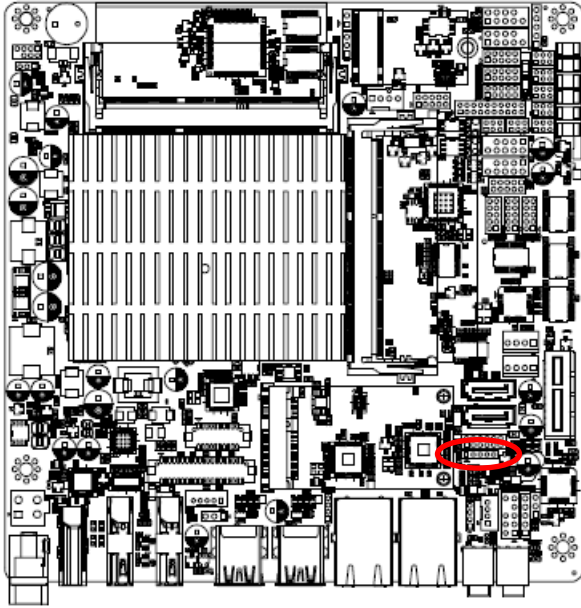

| PIN | Signal |
|-----|--------------|
| 1 | +3.3V |
| 2 | I2C5_INT# |
| 3 | I2C5_LS_CLK |
| 4 | I2C5_LS_DATA |
| 5 | GND |

3. BIOS Setup

3.1 Introduction

The BIOS setup program allows users to modify the basic system configuration. In this following chapter will describe how to access the BIOS setup program and the configuration options that may be changed.

3.2 Starting Setup

The AMI BIOS™ is immediately activated when you first power on the computer. The BIOS reads the system information contained in the NVRAM and begins the process of checking out the system and configuring it. When it finishes, the BIOS will seek an operating system on one of the disks and then launch and turn control over to the operating system.

While the BIOS is in control, the Setup program can be activated in one of two ways:

By pressing or <F2> immediately after switching the system on, or

By pressing the or <F2> key when the following message appears briefly at the left-top of the screen during the POST (Power On Self Test).

Press or <F2> to enter SETUP

If the message disappears before you respond and you still wish to enter Setup, restart the system to try again by turning it OFF then ON or pressing the "RESET" button on the system case. You may also restart by simultaneously pressing <Ctrl>, <Alt>, and <Delete> keys. If you do not press the keys at the correct time and the system does not boot, an error message will be displayed and you will again be asked to.

Press F1 to Continue, DEL to enter SETUP

3.3 Using Setup

In general, you use the arrow keys to highlight items, press <Enter> to select, use the PageUp and PageDown keys to change entries, press <F1> for help and press <Esc> to quit. The following table provides more detail about how to navigate in the Setup program using the keyboard.

| Button | Description |
|---------|---|
| ↑ | Move to previous item |
| ↓ | Move to next item |
| ← | Move to the item in the left hand |
| → | Move to the item in the right hand |
| Esc key | Main Menu -- Quit and not save changes into NVRAM Status Page Setup Menu and Option Page Setup Menu -- Exit current page and return to Main Menu |
| + key | Increase the numeric value or make changes |
| - key | Decrease the numeric value or make changes |
| F1 key | General help, only for Status Page Setup Menu and Option Page Setup Menu |
| F2 key | Previous Values. |
| F3 key | Optimized defaults |
| F4 key | Save & Exit Setup |

- **Navigating Through The Menu Bar**

Use the left and right arrow keys to choose the menu you want to be in.



Note: Some of the navigation keys differ from one screen to another.

- **To Display a Sub Menu**

Use the arrow keys to move the cursor to the sub menu you want. Then press <Enter>. A “>” pointer marks all sub menus.

3.4 Getting Help

Press F1 to pop up a small help window that describes the appropriate keys to use and the possible selections for the highlighted item. To exit the Help Window press <Esc> or the F1 key again.

3.5 In Case of Problems

If, after making and saving system changes with Setup, you discover that your computer no longer is able to boot, the AMI BIOS supports an override to the NVRAM settings which resets your system to its defaults.

The best advice is to only alter settings which you thoroughly understand. To this end, we strongly recommend that you avoid making any changes to the chipset defaults. These defaults have been carefully chosen by both BIOS Vendor and your systems manufacturer to provide the absolute maximum performance and reliability. Even a seemingly small change to the chipset setup has the potential for causing you to use the override.

3.6 BIOS setup

Once you enter the Aptio Setup Utility, the Main Menu will appear on the screen. The Main Menu allows you to select from several setup functions and exit choices. Use the arrow keys to select among the items and press <Enter> to accept and enter the sub-menu.

3.6.1 Main Menu

This section allows you to record some basic hardware configurations in your computer and set the system clock.

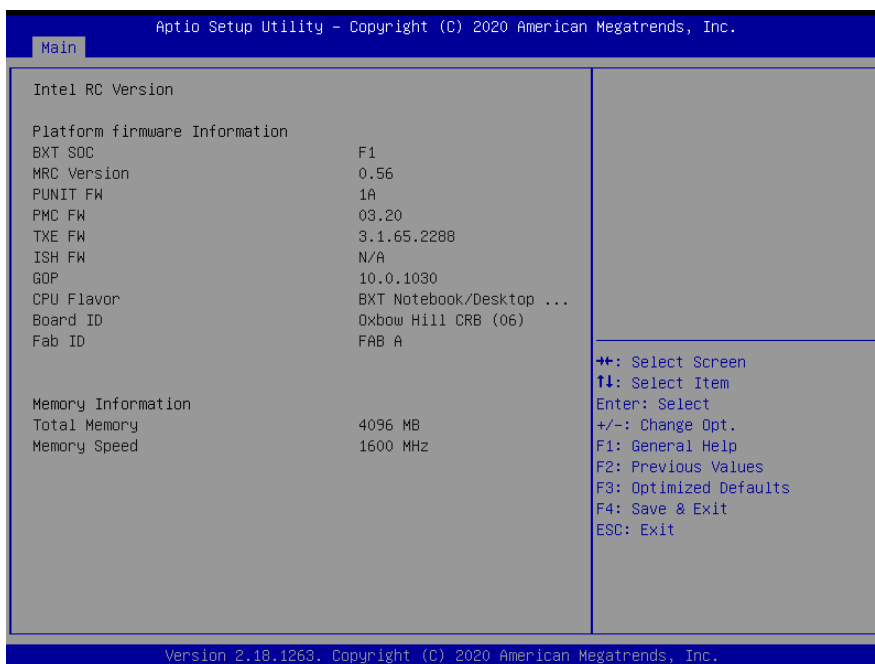

3.6.1.1 System Language

This option allows choosing the system default language.

3.6.1.2 System Date

Use the system date option to set the system date. Manually enter the day, month and year.

3.6.1.3 System Time

Use the system time option to set the system time. Manually enter the hours, minutes and seconds.



Note: The BIOS setup screens shown in this chapter are for reference purposes only, and may not exactly match what you see on your screen.

Visit the Avalue website (www.avalue.com.tw) to download the latest product and BIOS information.

3.6.2 Advanced Menu

This section allows you to configure your CPU and other system devices for basic operation through the following sub-menus.

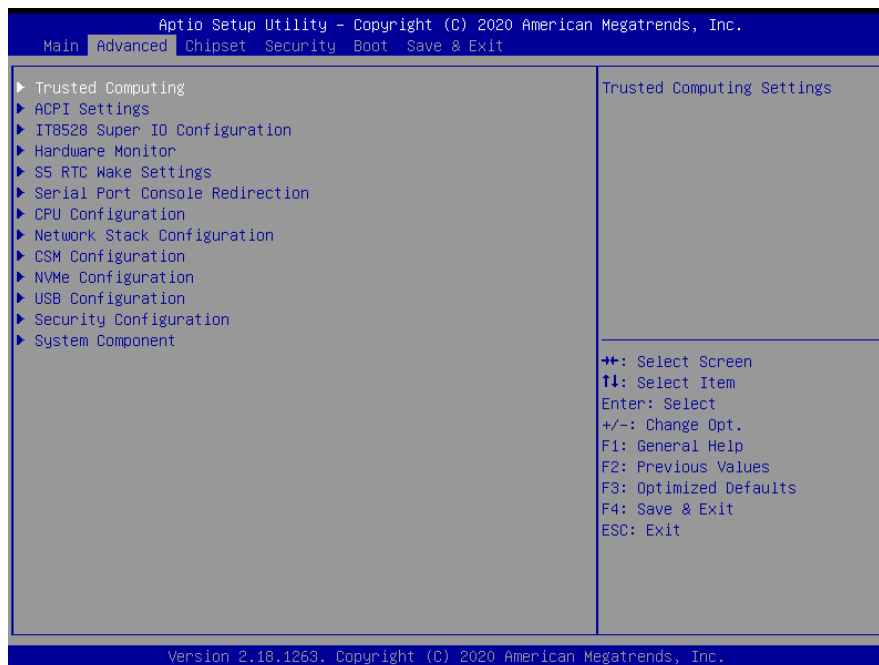

3.6.2.1 Trusted Computing



| Item | Options | Description |
|--------------------------------|-----------------------------------|--|
| Security Device Support | Disable, Enable[Default] | Enables or Disables BIOS support for security device. O.S. will not show Security Device. TCG EFI protocol and INT1Ainterface will not be available. |

3.6.2.2 ACPI Settings

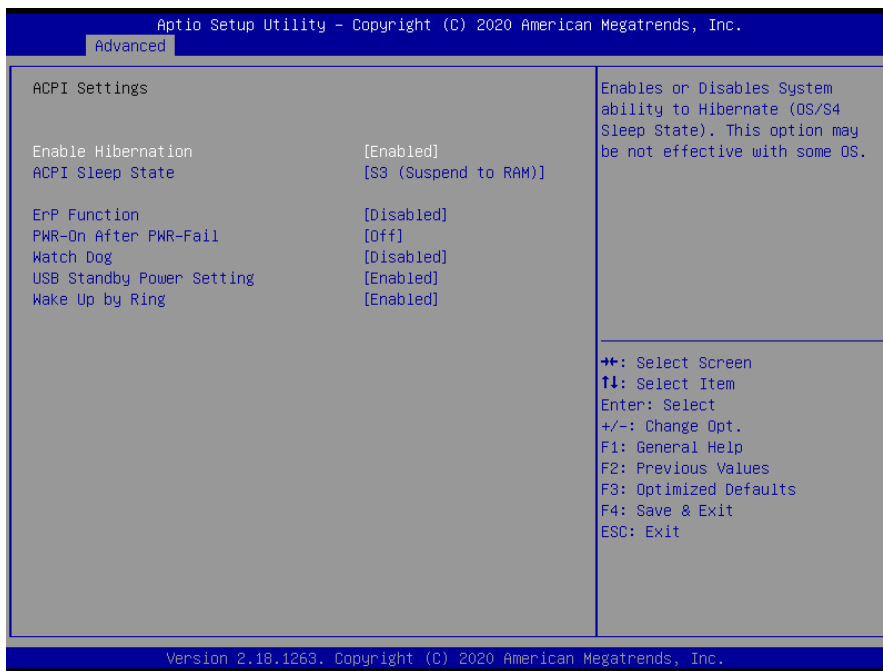

| Item | Options | Description |
|---------------------------|-------------------------------------|---|
| Enable Hibernation | Disabled Enabled[Default], | Enables or Disables System ability to Hibernate (OS/S4 Sleep State). This option may be not effective with some |

| | | |
|----------------------------------|---|---|
| | | OS. |
| ACPI Sleep State | Suspend Disabled, S3 (Suspend to RAM)[Default] | Select the highest ACPI sleep state the system will enter when the SUSPEDN button is pressed. |
| ErP Function | Disabled[Default], Enabled | ErP Function (Deep S5). |
| PWR-On After PWR-Fail | Off[Default] On Last state | AC loss resume. |
| Watch Dog | Disabled[Default], 30 sec 40 sec 50 sec 1 min 2 min 10 min 30 min | Select WatchDog. |
| USB Standby Power Setting | Disabled Enabled[Default], | Enabled/Disabled USB Standby Power during S3/S4/S5. |
| Wake Up by Ring | Disabled Enabled[Default], | Wake Up by Ring from S3/S4/S5. |

3.6.2.3 IT8528 Super IO Configuration

You can use this item to set up or change the IT8528 Super IO configuration for serial ports. Please refer to 3.6.2.3.1~ 3.6.2.3.5 for more information.

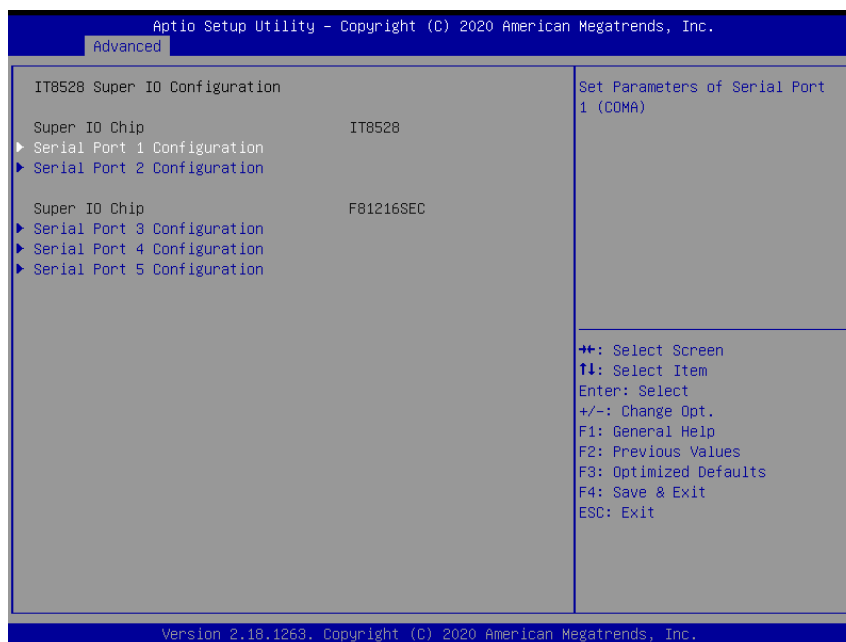

| Item | Description |
|------------------------------------|---|
| Serial Port 1 Configuration | Set Parameters of Serial Port 1 (COMA). |

OFP-21W33

| | |
|------------------------------------|---|
| Serial Port 2 Configuration | Set Parameters of Serial Port 2 (COMB). |
| Serial Port 3 Configuration | Set Parameters of Serial Port 3 (COMC). |
| Serial Port 4 Configuration | Set Parameters of Serial Port 4 (COMD). |
| Serial Port 5 Configuration | Set Parameters of Serial Port 5 (COME). |

3.6.2.3.1 Serial Port 1 Configuration

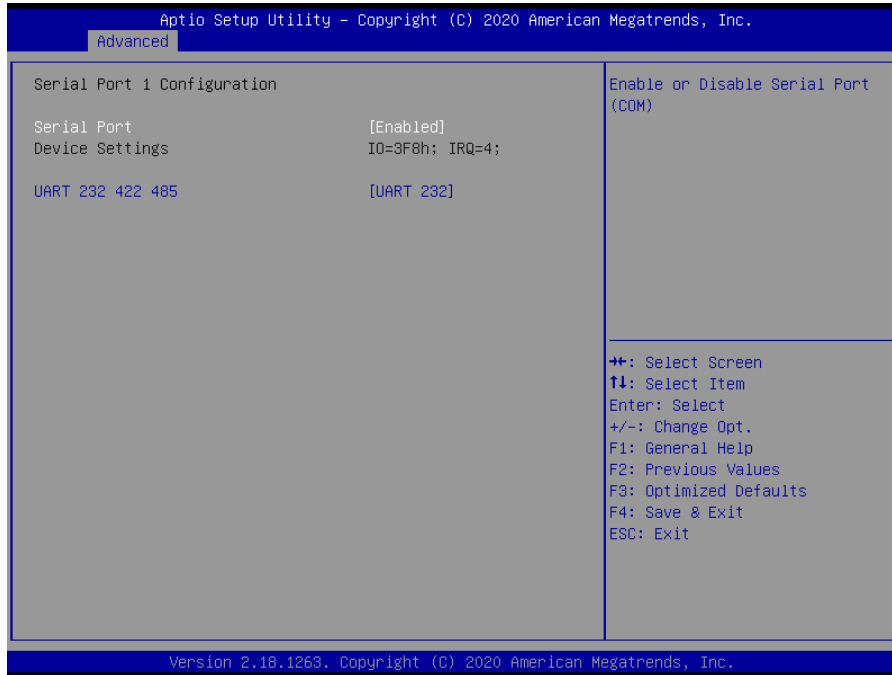

| Item | Option | Description |
|-------------------------|---|--|
| Serial Port | Enabled[Default], Disabled | Enable or Disable Serial Port (COM). |
| UART 232 422 485 | UART 232[Default], UART 422, UART 485 | Change the Serial Port as RS232/422/485. |

3.6.2.3.2 Serial Port 2 Configuration

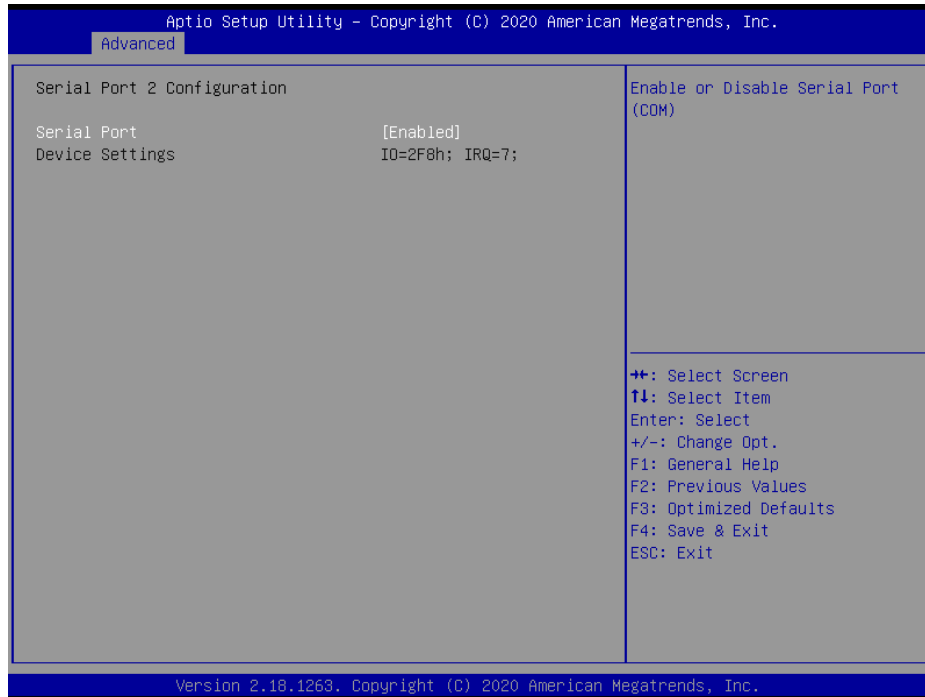

| Item | Option | Description |
|-------------|-------------------------------|--------------------------------------|
| Serial Port | Enabled[Default], Disabled | Enable or Disable Serial Port (COM). |

3.6.2.3.3 Serial Port 3 Configuration

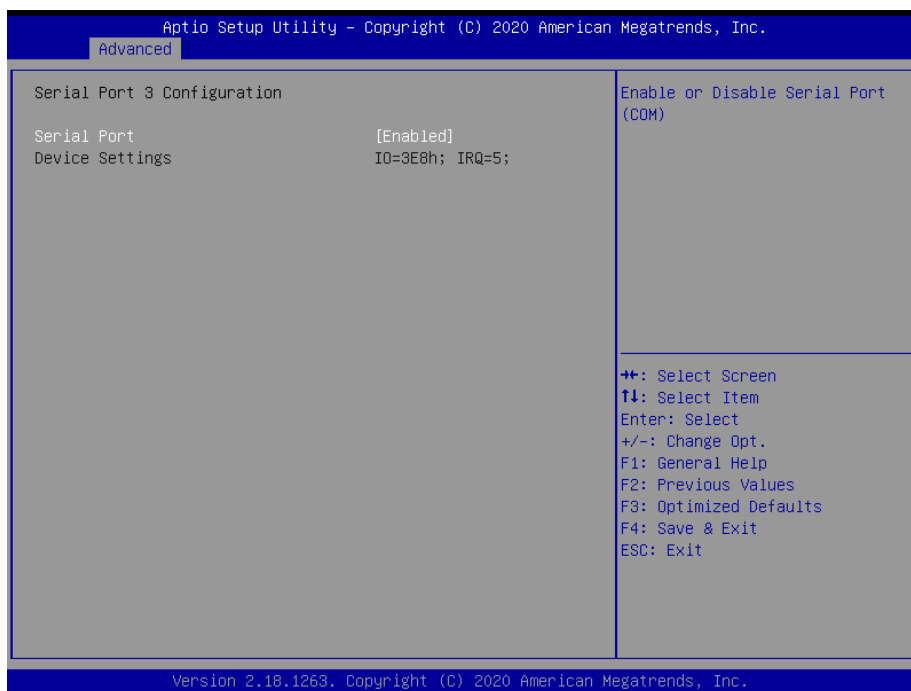

| Item | Option | Description |
|-------------|-------------------------------|--------------------------------------|
| Serial Port | Enabled[Default], Disabled | Enable or Disable Serial Port (COM). |

3.6.2.3.4 Serial Port 4 Configuration

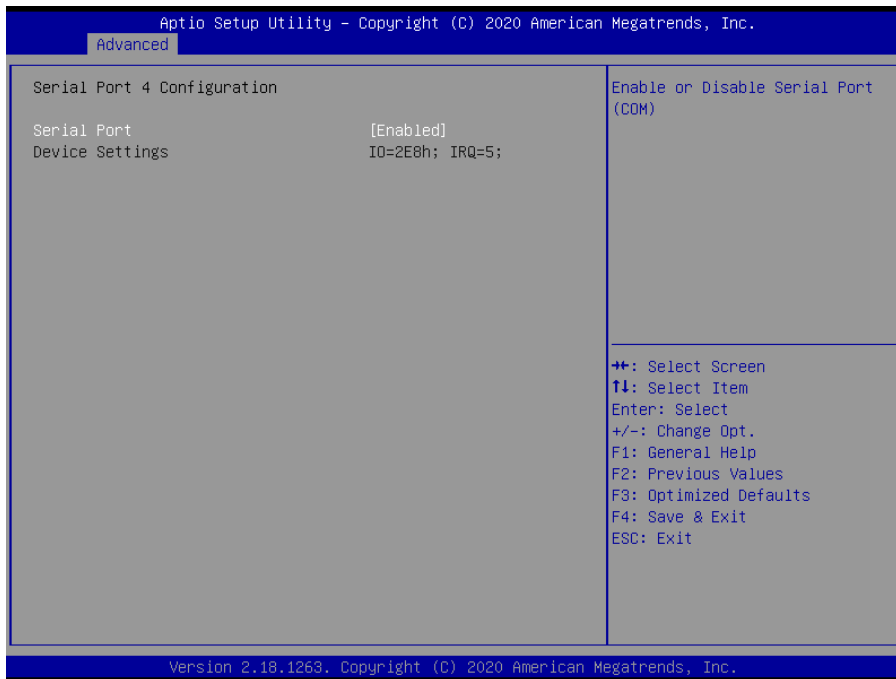

| Item | Option | Description |
|-------------|----------------------------|--------------------------------------|
| Serial Port | Enabled[Default], Disabled | Enable or Disable Serial Port (COM). |

3.6.2.3.5 Serial Port 5 Configuration

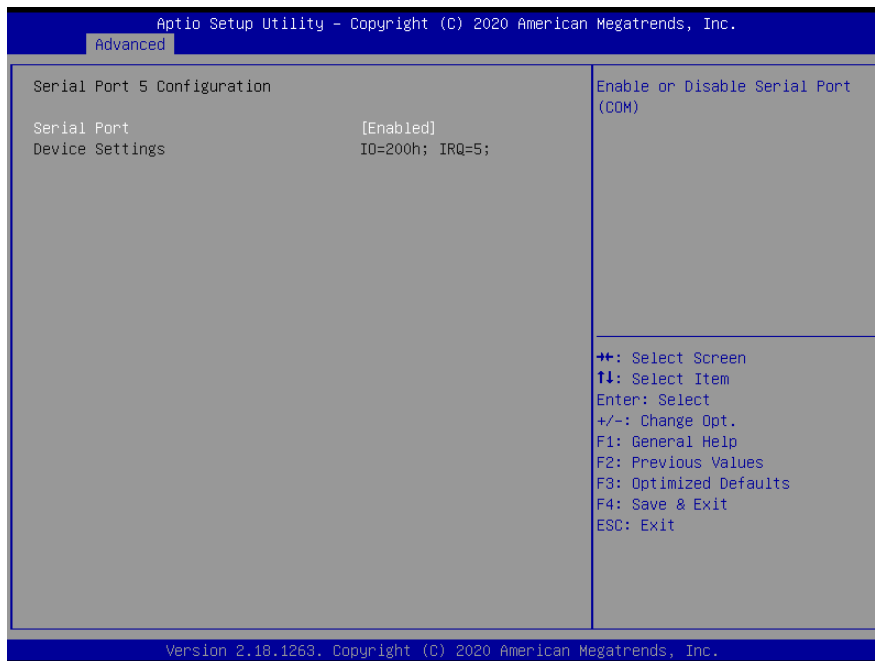

| Item | Option | Description |
|-------------|----------------------------|--------------------------------------|
| Serial Port | Enabled[Default], Disabled | Enable or Disable Serial Port (COM). |

3.6.2.4 H/W Monitor

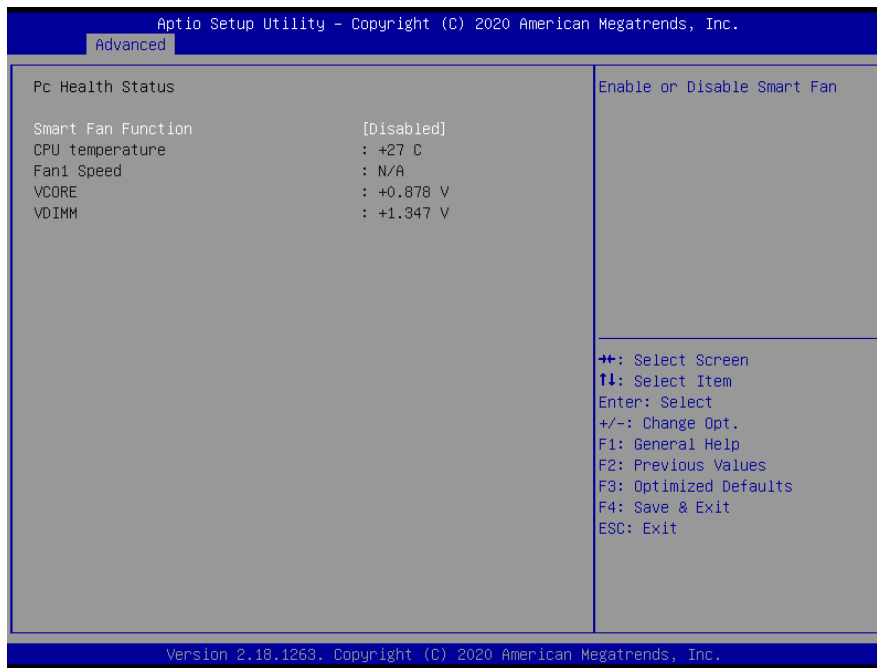

| Item | Options | Description |
|--------------------|-------------------------------|------------------------------|
| Smart Fan Function | Enabled, Disabled[Default] | Enable or Disable Smart Fan. |

3.6.2.4.1 Smart Fan Mode Configuration

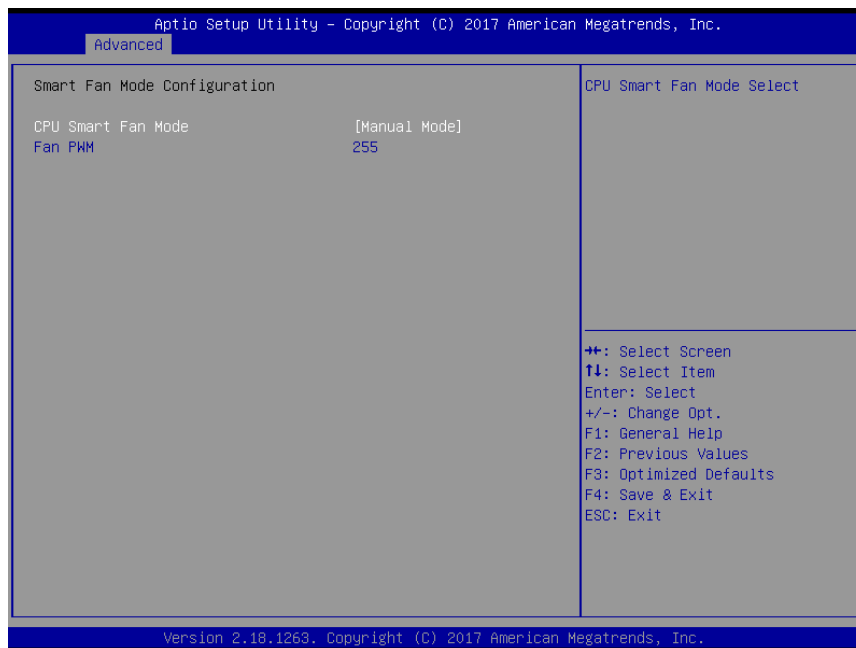

| Item | Option | Description |
|--------------------|---|----------------------------|
| CPU Smart Fan Mode | Manual Mode[Default]/Mode 01/Mode 02/Mode 03/Mode 04/Mode 05/Mode 06/Mode | CPU Smart Fan Mode Select. |

OFP-21W33

| | | |
|----------------|--|---------------|
| | 07/Mode 08/Mode 09/Mode 10/Mode 11/Mode 12/Mode 13/Mode 14/Mode 15/Mode 16/Mode 17/Mode 18/Mode 19/Mode 20 | |
| Fan PWM | 0-255 | Fan PWM duty. |

3.6.2.5 S5 RTC Wake Settings

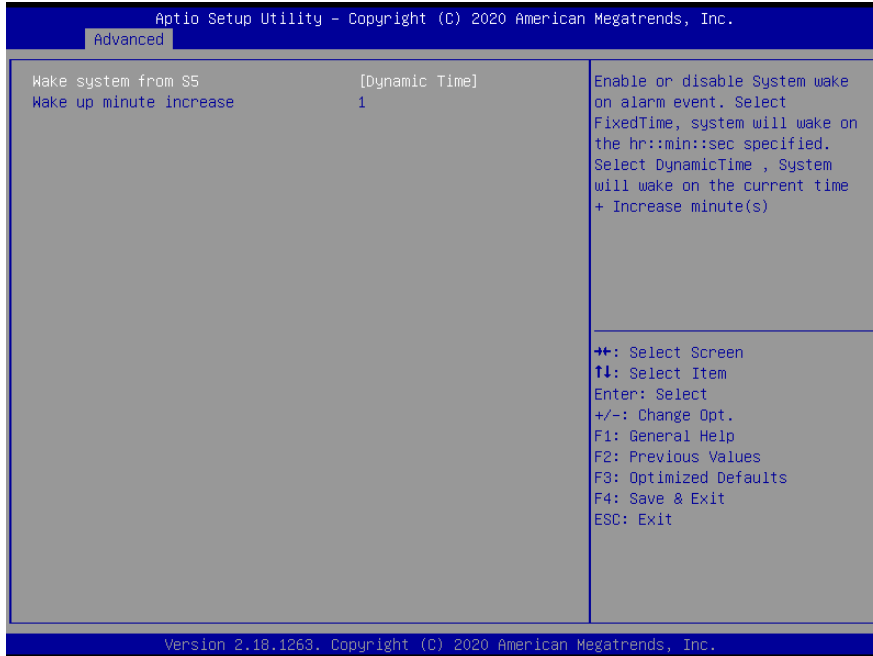

| Item | Options | Description |
|--------------------------------|--|--|
| Wake system from S5 | Disabled[Default], Fixed Time Dynamic Time | Enable or disable System wake on alarm event. Select Fixed Time, system will wake on the hr::min::sec specified. Select Dynamic Time, System will wake on the current time + Increase minute(s). |
| Wake up minute increase | 1-5 | Wake up minute increase. |

Quick Reference Guide

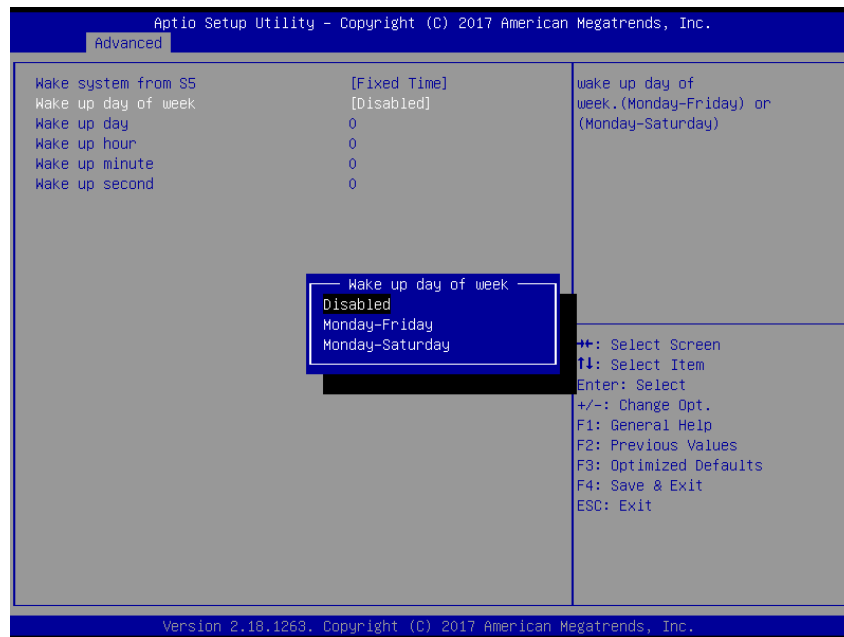

| Item | Options | Description |
|----------------------------|--|--|
| Wake system from S5 | Disabled, Fixed Time[Default] Dynamic Time | Enable or disable System wake on alarm event. Select Fixed Time, system will wake on the hr::min::sec specified. Select Dynamic Time, System will wake on the current time + Increase minute(s). |
| Wake up day of week | Disabled[Default] Monday-Friday Monday-Saturday | Wake up day of week. (Monday-Friday) or (Monday-Saturday). |
| Wake up day | 1-31 | Select 0 for daily system wake up 1-31 for which day of the month that you would like the system to wake up. |
| Wake up hour | 0-23 | Select 0-23 For example enter 3 for 3am and 15 for 3pm. |
| Wake up minute | 0-23 | Select 0-23 For example enter 3 for 3am and 15 for 3pm. |
| Wake up second | 0-23 | Select 0-23 For example enter 3 for 3am and 15 for 3pm. |

3.6.2.6 Serial Port Console Redirection

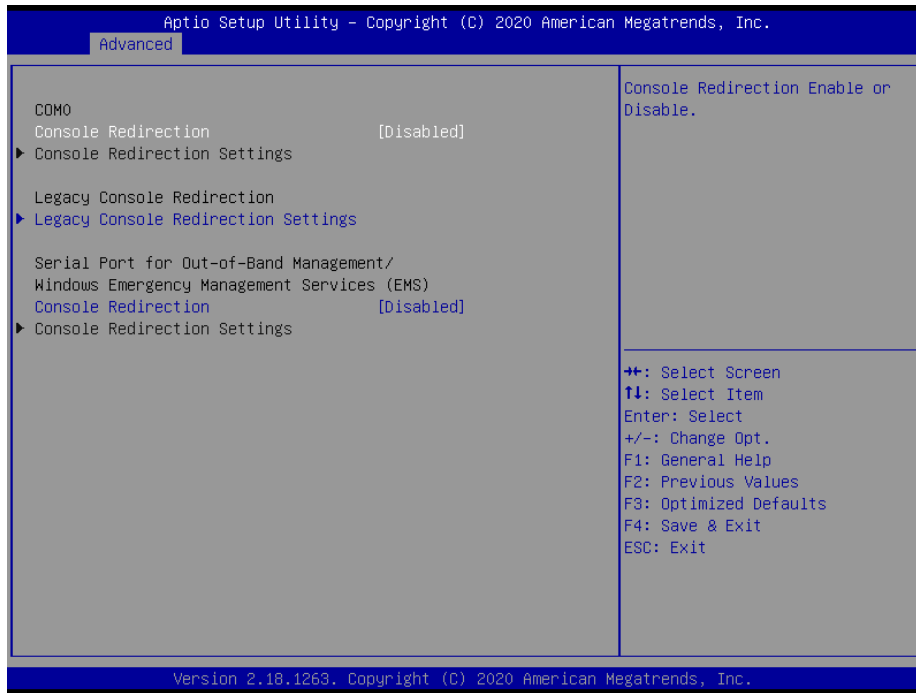

| Item | Options | Description |
|---------------------|-------------------------------|--|
| Console Redirection | Disabled[Default], Enabled | Console Redirection Enable or Disable. |

3.6.2.7 CPU Configuration

Use the CPU configuration menu to view detailed CPU specification and configure the CPU.

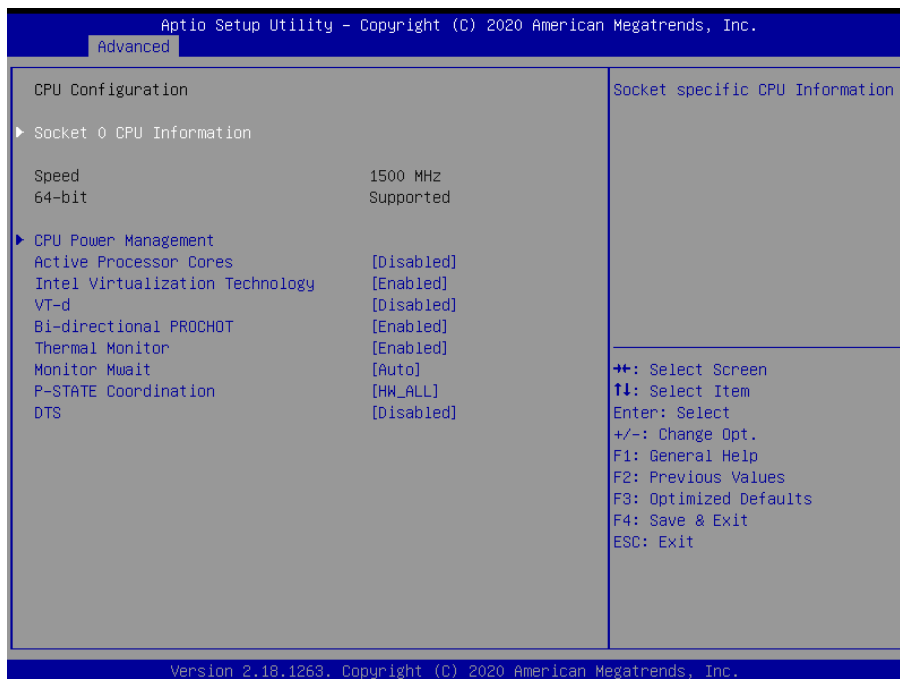

| Item | Options | Description |
|--|---------------------------------------|---|
| Active Processor Cores | Disabled[Default], Enabled | Number of cores to enable in each processor package. |
| Intel Virtualization Technology | Disabled, Enabled[Default] | When enabled, a VMM can utilize the additional hardware capabilities provided by Virtualization Technology. |
| VT-d | Disabled[Default], Enabled | Enable/Disable CPU VT-d. |
| Bi-directional PROCHOT | Disabled, Enabled[Default] | When a processor thermal sensor trips (either core), the PROCHOT# will be driven. If bi-direction is enabled, external agents can drive PROCHOT# to throttle the processor. |
| Thermal Monitor | Disabled, Enabled[Default] | Enable/Disable Thermal Monitor. |
| Monitor Mwait | Disabled, Enabled Auto[Default] | Enable/Disable Monitor Mwait. |
| P-STATE Coordination | HW_ALL[Default] SW_ALL SW_ANY | Change P-STATE Coordination type. |
| DTS | Disabled[Default], Enabled | Enable/Disable Digital Thermal Sensor. |

3.6.2.7.1 Socket 0 CPU Information

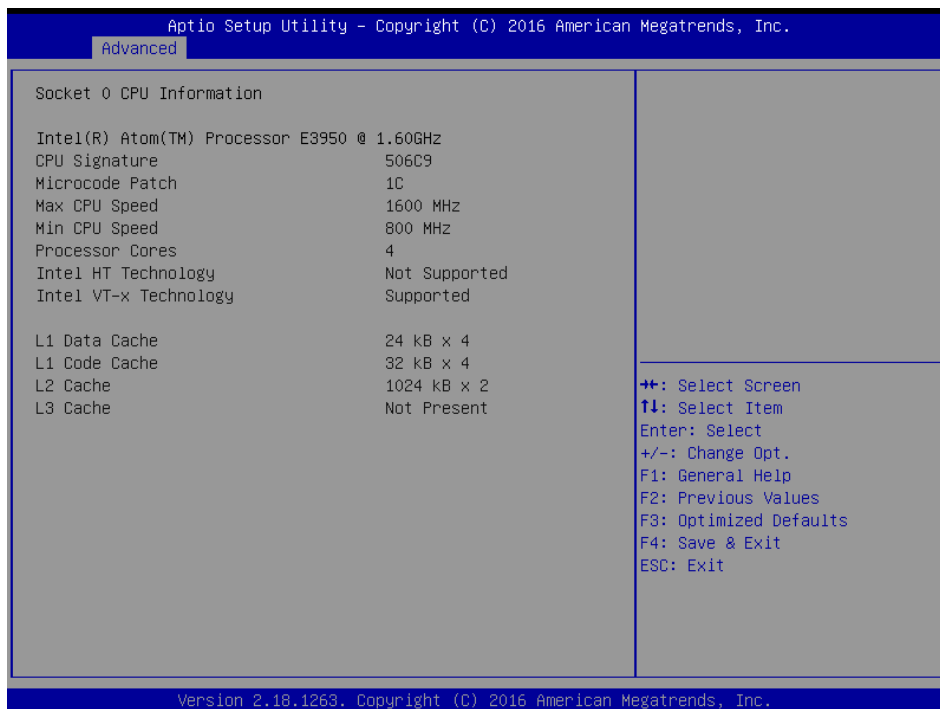

3.6.2.7.2 CPU Power Management Configuration

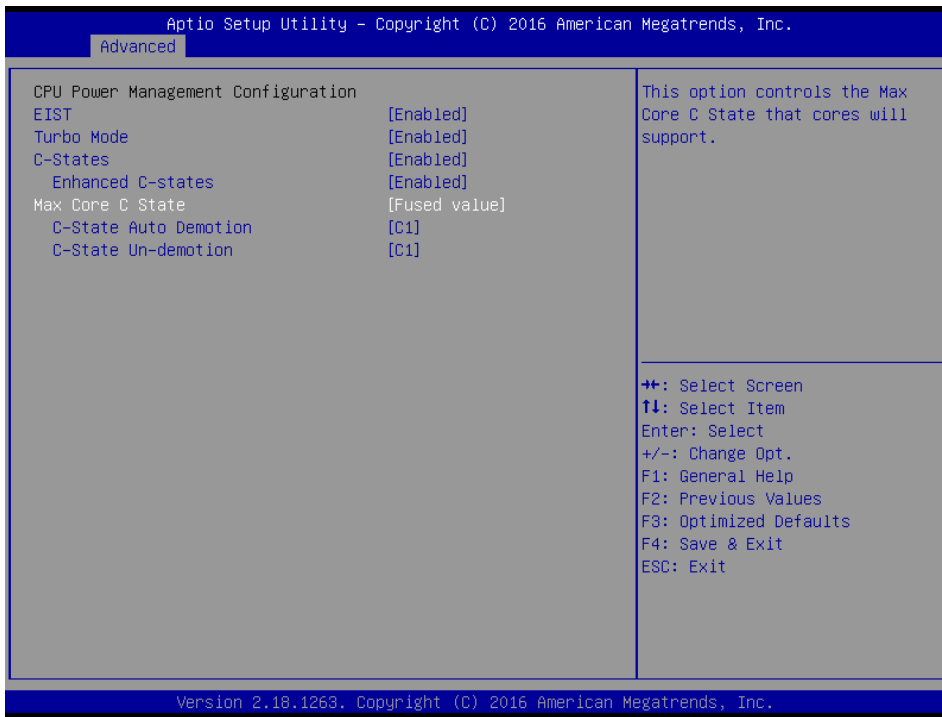

| Item | Options | Description |
|------------------------------|--|--|
| EIST | Disabled, Enabled [Default] | Enable/Disable Intel SpeedStep. |
| Turbo Mode | Disabled, Enabled [Default] | Turbo Mode. |
| C-States | Disabled, Enabled [Default] | Enable/Disable C State. |
| Enhanced C-states | Disabled, Enabled [Default] | Enable/Disable C1E. When enabled, CPU will switch to minimum speed when all cores enter C-State. |
| Max Core C State | Fused value [Default] Core C10 Core C9 Core C8 Core C7 Core C6 Core C1 Unlimited | This option controls the Max Core C State that cores will support. |
| C-State Auto Demotion | Disabled C1 [Default] | Configure C-State Auto Demotion. |
| C-State Un-demotion | Disabled C1 [Default] | Configure C-State Un-demotion. |

3.6.2.8 Network Stack Configuration

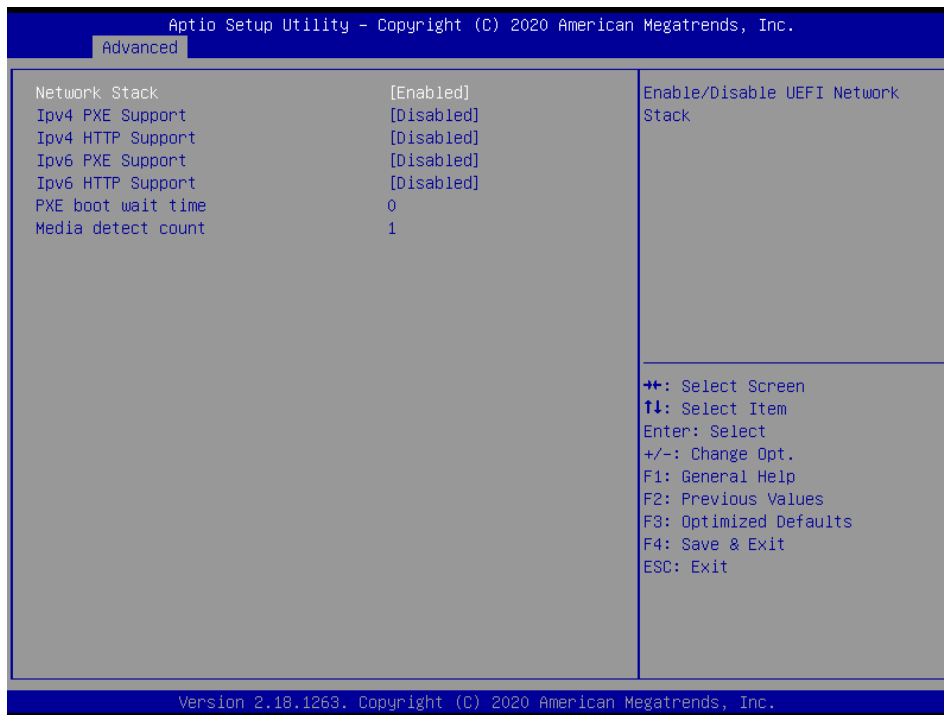

| Item | Options | Description |
|---------------------------|------------------------------|---|
| Network Stack | Disabled[Default] Enabled | Enable/Disable UEFI Network Stack. |
| Ipv4 PXE Support | Disabled[Default] Enabled | Enable Ipv4 PXE Boot Support. If disabled IPV4 PXE boot option will not be created. |
| Ipv4 HTTP Support | Disabled[Default] Enabled | Enable Ipv4 HTTP Boot Support. If disabled IPV4 HTTP boot option will not be created. |
| Ipv6 PXE Support | Disabled[Default] Enabled | Enable Ipv6 PXE Boot Support. If disabled IPV6 PXE boot option will not be created. |
| Ipv6 HTTP Support | Disabled[Default] Enabled | Enable Ipv6 HTTP Boot Support. If disabled IPV6 HTTP boot option will not be created. |
| PXE boot wait time | 0 | Wait time to press ESC key to abort the PXE boot. |
| Media detect count | 1 | Number of times presence of media will be checked. |

3.6.2.9 NVMe Configuration

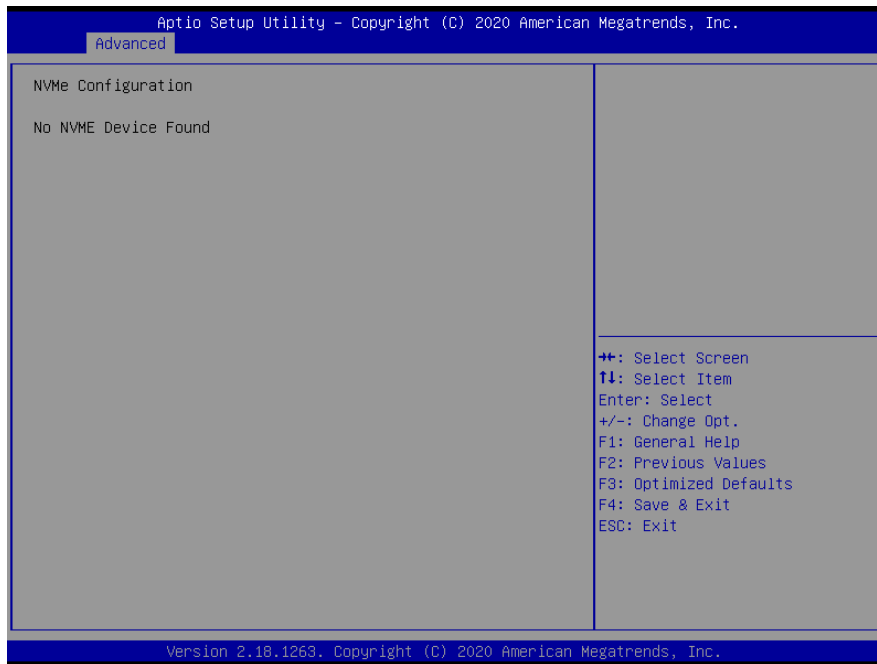

3.6.2.10 CSM Configuration

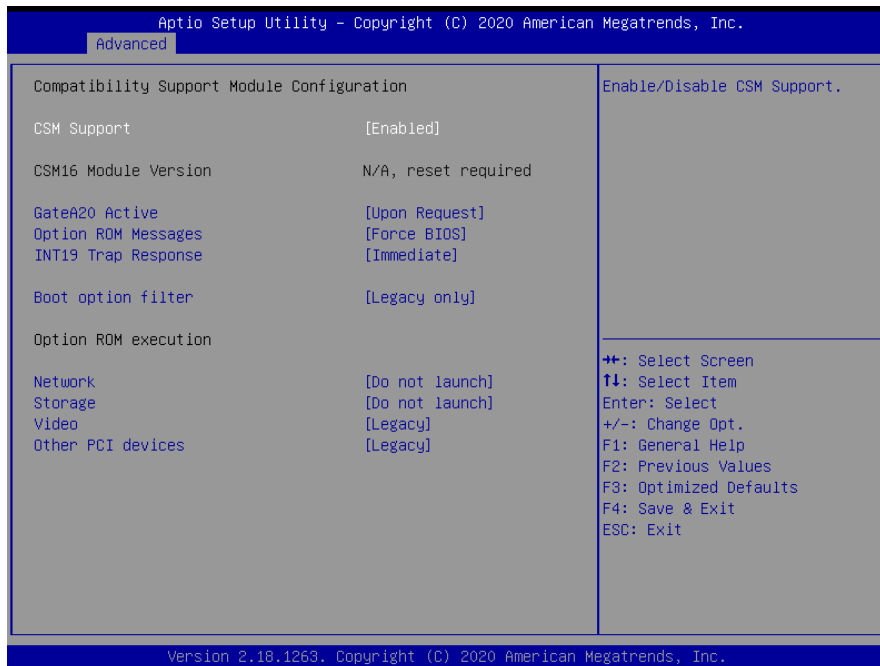

| Item | Options | Description |
|-----------------------|---------------------------------|--|
| CSM Support | Disabled[Default], Enabled | Enable/Disable CSM Support. |
| GateA20 Active | Upon Request[Default] Always | UPON REQUEST – GA20 can be disabled using BIOS services. ALWAYS – do not allow disabling GA20; this option is useful when any RT code is executed above 1MB. |

| | | |
|----------------------------|--|--|
| Option ROM Messages | Force BIOS Keep Current[Default] | Set display mode for Option ROM. |
| INT19 Trap Response | Immediate[Default] Postponed | BIOS reaction on INT19 trapping by Option ROM: IMMEDIATE – execute the trap right away; POSTPONED – execute the trap during legacy boot. |
| Boot option filter | UEFI and Legacy Legacy only[Default] UEFI only | This option controls Legacy/UEFI ROMs priority. |
| Network | Do not launch[Default] UEFI Legacy | Controls the execution of UEFI and Legacy PXE OpROM. |
| Storage | Do not launch[Default] UEFI Legacy | Controls the execution of UEFI and Legacy Storage OpROM. |
| Video | Do not launch UEFI Legacy[Default] | Controls the execution of UEFI and Legacy Video OpROM. |
| Other PCI devices | Do not launch UEFI Legacy[Default] | Determines OpROM execution policy for devices other than Network, Storage, or Video. |

3.6.2.11 USB Configuration

The USB Configuration menu helps read USB information and configures USB settings.

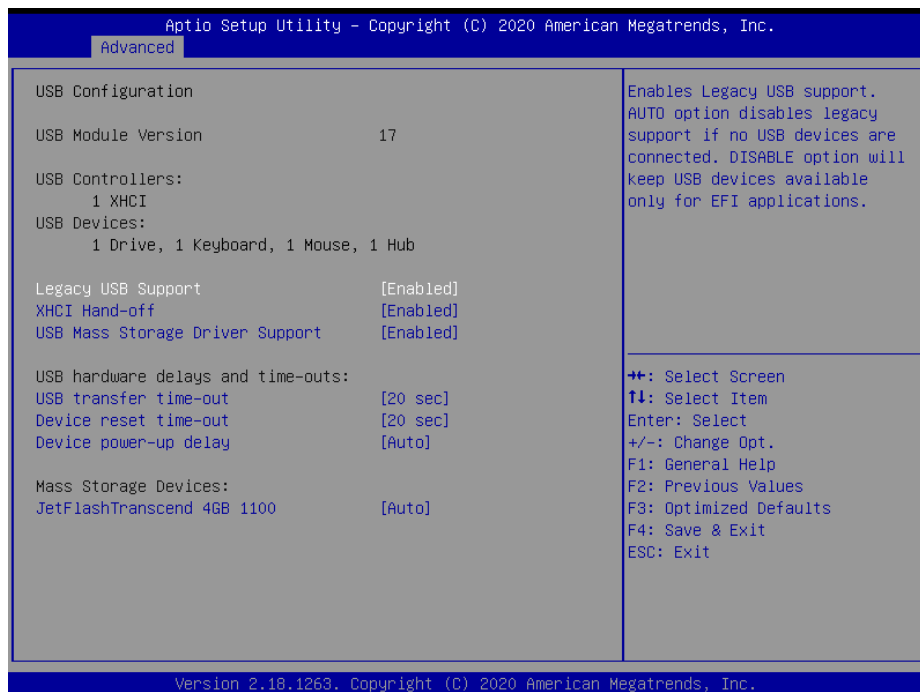

| Item | Options | Description |
|---------------------------|--------------------------------------|--|
| Legacy USB Support | Enabled[Default] Disabled Auto | Enables Legacy USB support. AUTO option disables legacy support if no USB devices are connected. DISABLE option will keep USB devices available only for EFI applications. |

| | | |
|--|--|--|
| XHCI Hand-off | Enabled[Default] Disabled | This is a workaround for OSes without XHCI hand-off support. The XHCI ownership change should be claimed by XHCI driver. |
| USB Mass Storage Driver Support | Disabled Enabled[Default] | Enable/Disable USB Mass Storage Driver Support. |
| USB transfer time-out | 1 sec 5 sec 10 sec 20 sec[Default] | The time-out value for Control, Bulk, and Interrupt transfers. |
| Device reset time-out | 10 sec 20 sec[Default] 30 sec 40 sec | USB mass storage device Start Unit command time-out. |
| Device power-up delay | Auto[Default] Manual | Maximum time the device will take before it properly reports itself to the Host Controller. 'Auto' uses default value: for a Root port it is 100ms, for a Hub port the delay is taken from Hub descriptor. |
| Mass Storage Devices | Auto[Default] Floppy Forced FDD Hard Disk CD-ROM | Mass storage device emulation type 'AUTO' enumerates devices according to their media format. Optical drives are emulated as 'CDROM', drives with no media will be emulated according to a drive type. |

3.6.2.12 Security Configuration



| Item | Options | Description |
|------------------------|-------------------------------|-----------------------------------|
| TXE HMRFP0 | Enabled, Disabled[Default] | TXE HMRFP0. |
| TXE EOP Message | Enabled[Default], Disabled | Send EOP Message Before Enter OS. |

3.6.2.13 System Component



| Item | Options | Description |
|-----------------|-----------------------------------|--------------------------------------|
| OS Reset Select | Warm Reset[Default] Cold Reset | Select the reset type in FACP table. |

3.6.3 Chipset



3.6.3.1 North Bridge

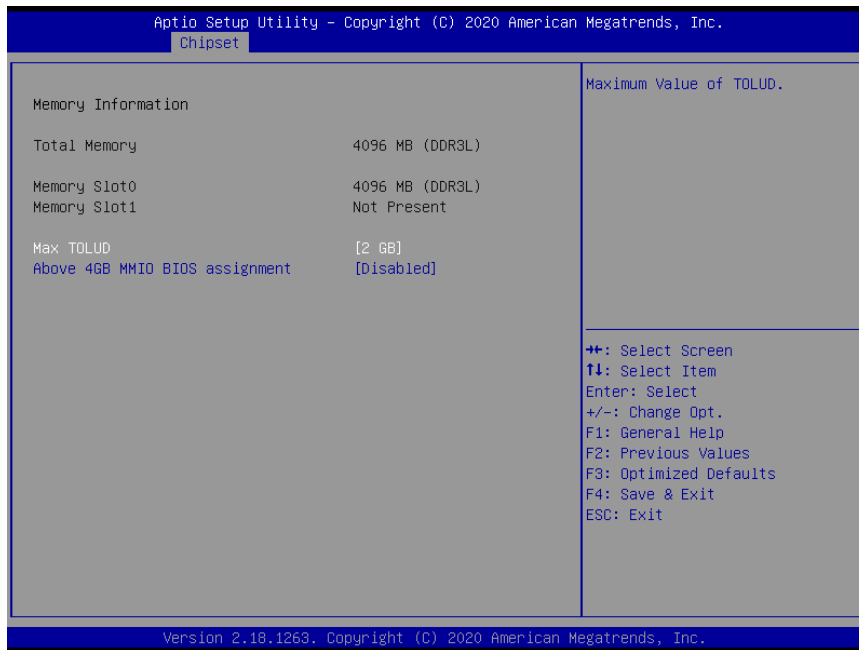

| Item | Option | Description |
|---------------------------------------|---|---|
| Max TOLUD | 2 GB[Default] 2.25 GB 2.5 GB 2.75 GB | Maximum Value of TOLUD. |
| Above 4GB MMIO BIOS assignment | Enabled Disabled[Default] | Enable/Disabel above 4GB MemoryMappedIO BIOS assignment This is disabled automatically when Aperture Size is set to 2048MB. |

3.6.3.2 South Bridge

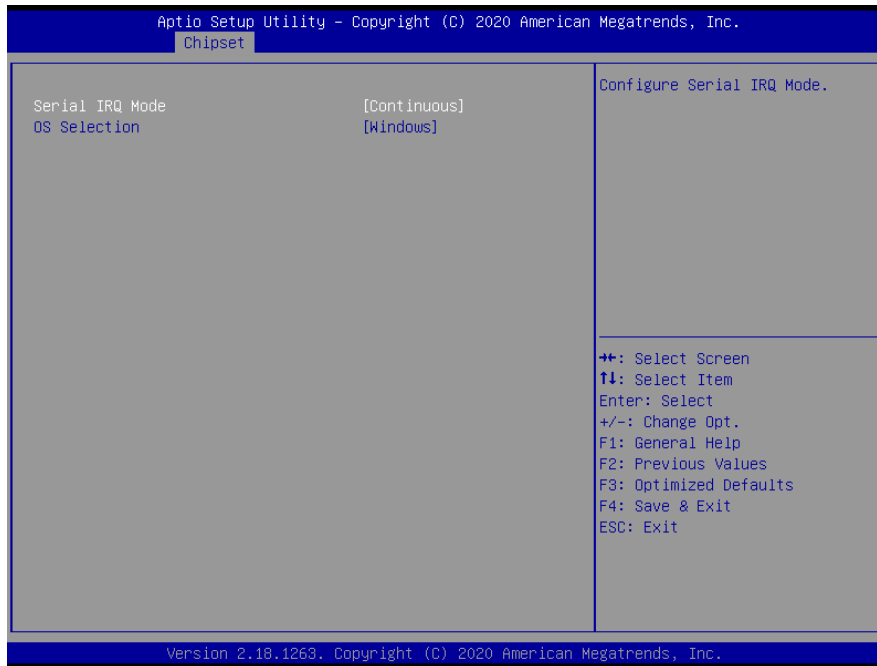

| Item | Option | Description |
|-----------------|--|----------------------------|
| Serial IRQ Mode | Quiet Continuous[Default] | Configure Serial IRQ Mode. |
| OS Selection | Windows[Default] Android Intel Linux | Select the target OS. |

3.6.3.3 Uncore Configuration

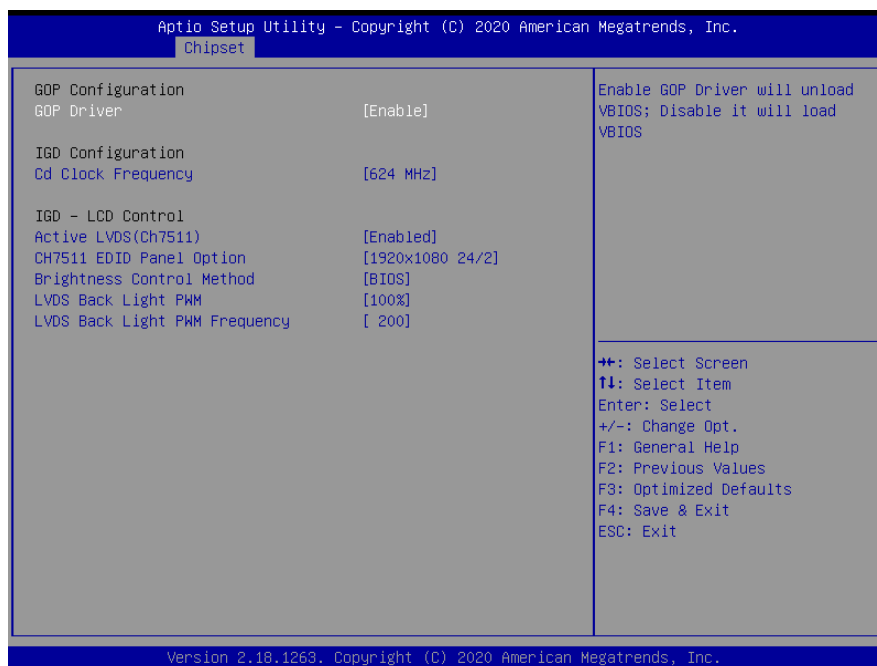

| Item | Option | Description |
|--------------------------------------|---|--|
| GOP Driver | Enable[Default] Disable | Enable GOP Driver will unload VBIOS; Disabled it will load VBIOS. |
| Cd Clock Frequency | 144 MHz 288 MHz 384 MHz 576 MHz 624 MHz[Default] | Select the highest Cd Clock frequency supported by the platform. |
| Active LVDS (Ch7511) | Disabled[Default] Enabled | Active Internal LVDS(eDP->Ch7511-to-LVDS). |
| CH7511 EDID Panel Option | 1024x768 24/1 800x600 18/1 1024x768 18/1 1366x768 18/1 1024x600 18/1 1280x800 18/1 1920x1200 24/2 1920x1080 18/2 1280x1024 24/2 1440x900 18/2 1600x1200 24/2 1366x768 24/1 1920x1080 24/2[Default] 1680x1050 24/2 | Port1-EDP to LVDS(Chrotel 7511) Panel EDID Option. |
| Brightness Control Method | BIOS[Default] BR Button VR OS Driver | LVDS Brightness Control Method. 1.BIOS 2.Brightness Button 3.Variable Resistor 4.OS Driver. |
| LVDS Back Light PWM | 00% 25% 50% 75% 100%[Default] | Select LVDS back light PWM duty. |
| LVDS Back Light PWM Frequency | 200[Default] 300 400 500 700 1k 2k 3k 5k 10k 20k | Select LVDS back light PWM Frequency. |

3.6.3.4 South Cluster Configuration

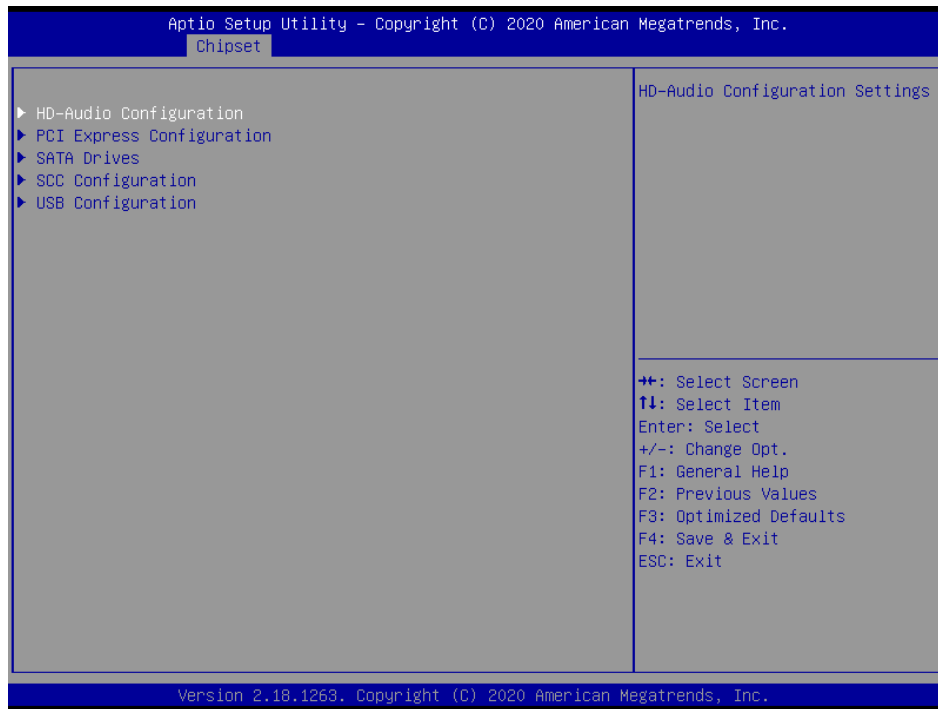

3.6.3.4.1 HD-Audio Configuration

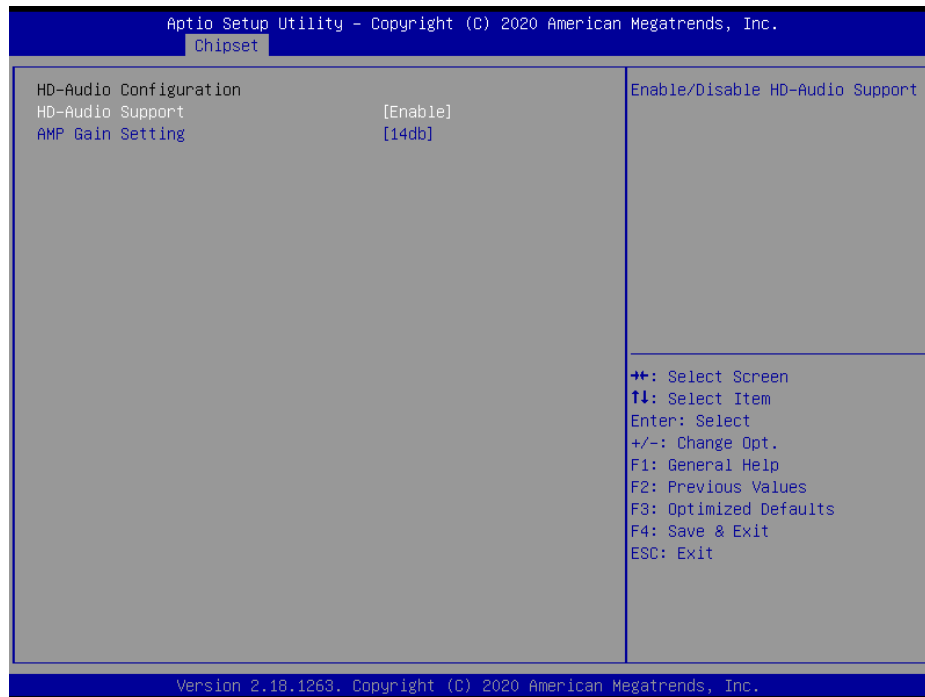

| Item | Option | Description |
|------------------|-----------------------------|----------------------------------|
| HD-Audio Support | Disable Enable[Default], | Enable/Disable HD-Audio Support. |

| | | |
|-------------------------|---------------------------------------|---------------------|
| AMP Gain Setting | 11db 14db[Default] 19db 25db | Select AMP Gain db. |
|-------------------------|---------------------------------------|---------------------|

3.6.3.4.2 PCI Express Configuration

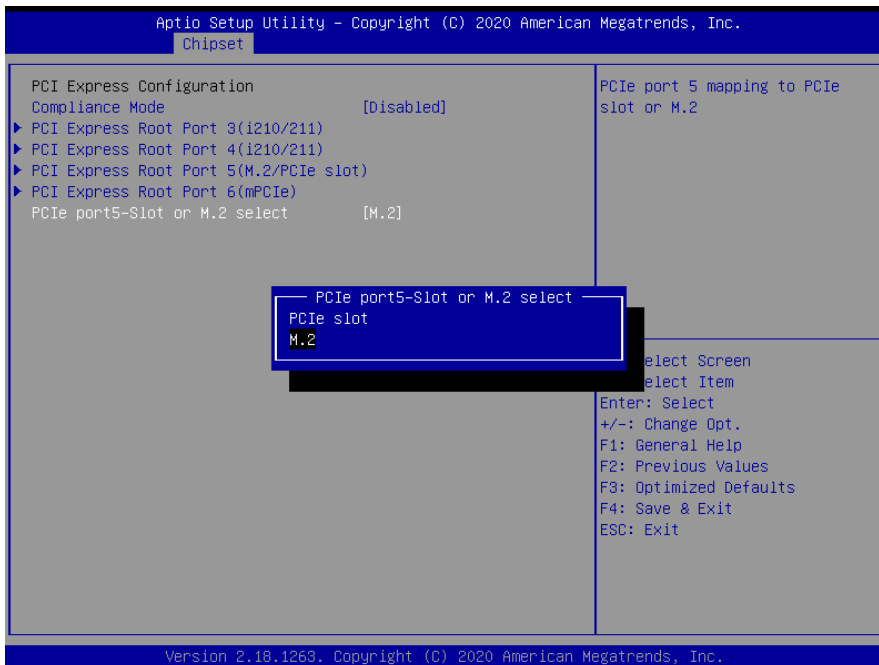
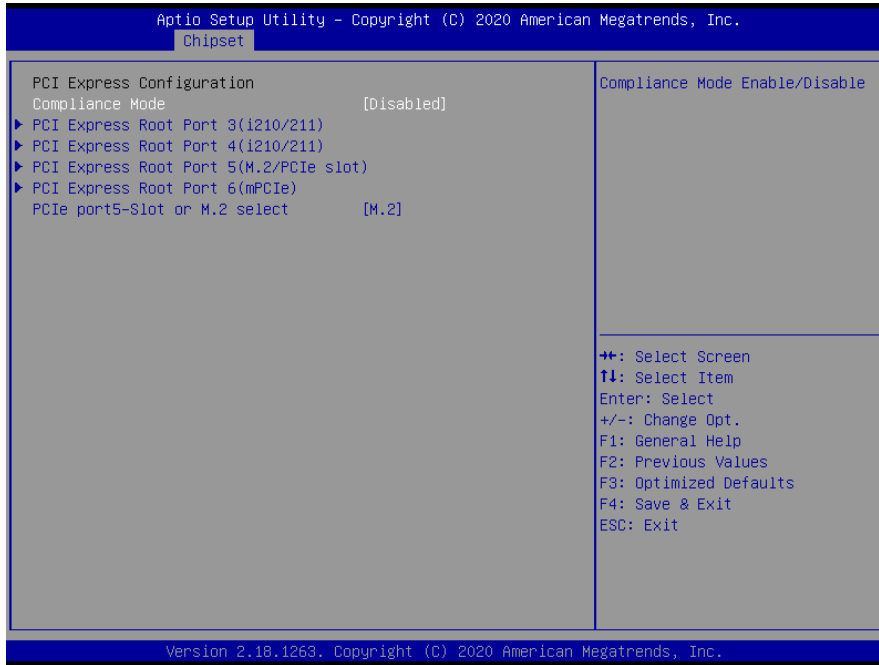

| Item | Option | Description |
|--------------------------------------|----------------------------|---|
| PCIe port5-Slot or M.2 select | PCIe slot M.2[Default], | PCIe port5 mapping to PCIe slot or M.2. |

3.6.3.4.2.1 PCI Express Root Port 3(i210/211)

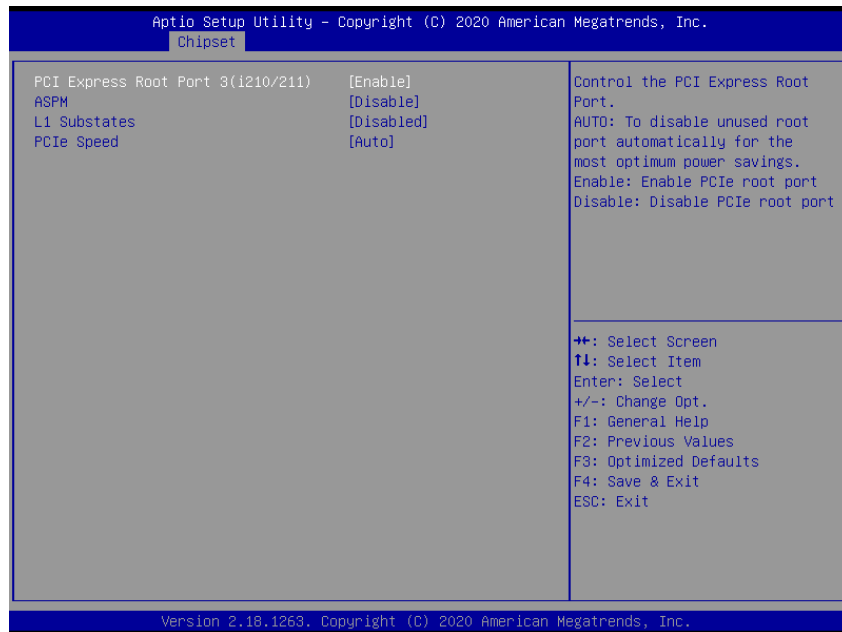

| Item | Option | Description |
|--|--|---|
| PCI Express Root Port 3(i210/211) | Disable Enable [Default] | Control the PCI Express Root Port. AUTO: To disable unused root port automatically for the most optimum power savings. Enable: Enable PCIe root port Disable: Disable PCIe root port. |
| ASPM | Disable [Default] L0s L1 L0sL1 Auto | PCI Express Active State Power Management settings. |
| L1 Substates | Disabled [Default] L1.1 L1.2 L1.1 & L1.2 | PCI Express L1 Substates settings. |
| PCIe Speed | Auto [Default] Gen 1 Gen 2 | Configure PCIe Speed. |

3.6.3.4.2.2 PCI Express Root Port 4(i210/211)

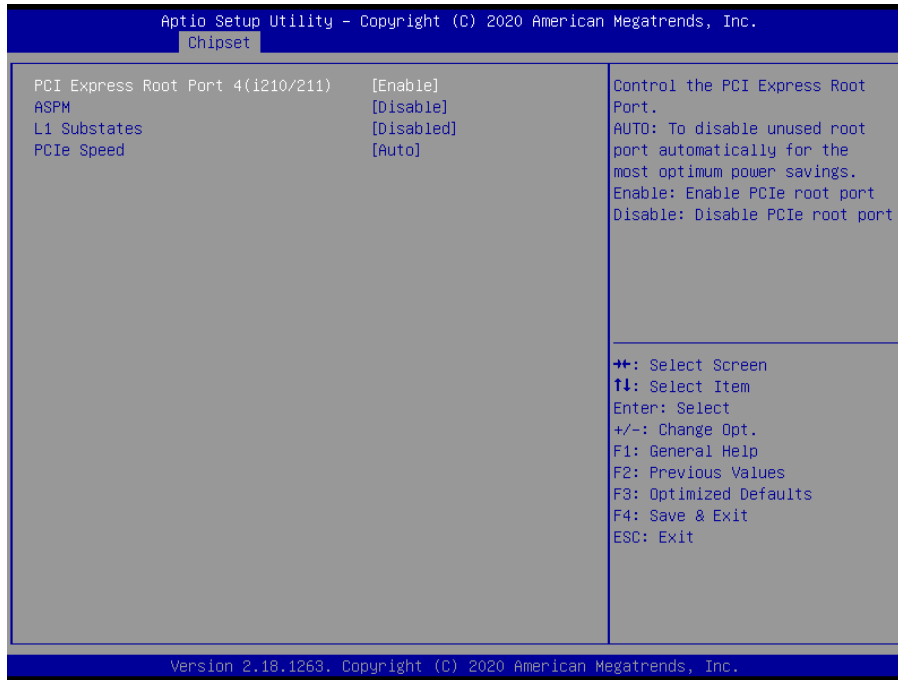

| Item | Option | Description |
|--|---|---|
| PCI Express Root Port 4(i210/211) | Disable Enable[Default] | Control the PCI Express Root Port. AUTO: To disable unused root port automatically for the most optimum power savings. Enable: Enable PCIe root port Disable: Disable PCIe root port. |
| ASPM | Disable[Default] L0s L1 L0sL1 Auto | PCI Express Active State Power Management settings. |
| L1 Substates | Disabled[Default] L1.1 L1.2 L1.1 & L1.2 | PCI Express L1 Substates settings. |
| PCIe Speed | Auto[Default] Gen 1 Gen 2 | Configure PCIe Speed. |

3.6.3.4.2.3 PCI Express Root Port 5(M.2/PCIe slot)

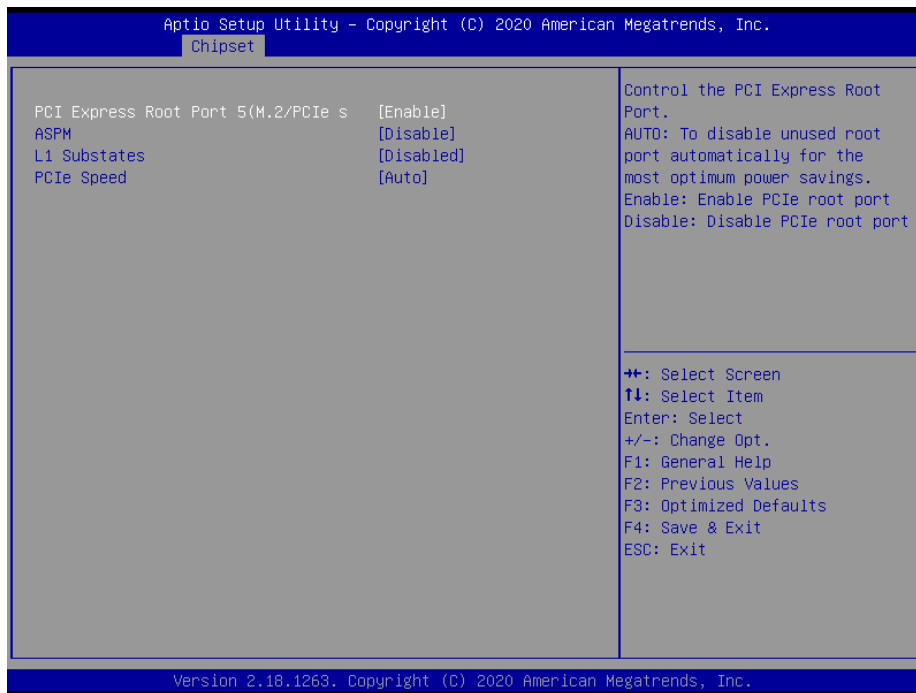

| Item | Option | Description |
|---|--|---|
| PCI Express Root Port 5(M.2/PCIe slot) | Disable Enable [Default] | Control the PCI Express Root Port. AUTO: To disable unused root port automatically for the most optimum power savings. Enable: Enable PCIe root port Disable: Disable PCIe root port. |
| ASPM | Disable [Default] L0s L1 L0sL1 Auto | PCI Express Active State Power Management settings. |
| L1 Substates | Disabled [Default] L1.1 L1.2 L1.1 & L1.2 | PCI Express L1 Substates settings. |
| PCIe Speed | Auto [Default] Gen 1 Gen 2 | Configure PCIe Speed. |

3.6.3.4.2.4 PCI Express Root Port 6(mPCIe)

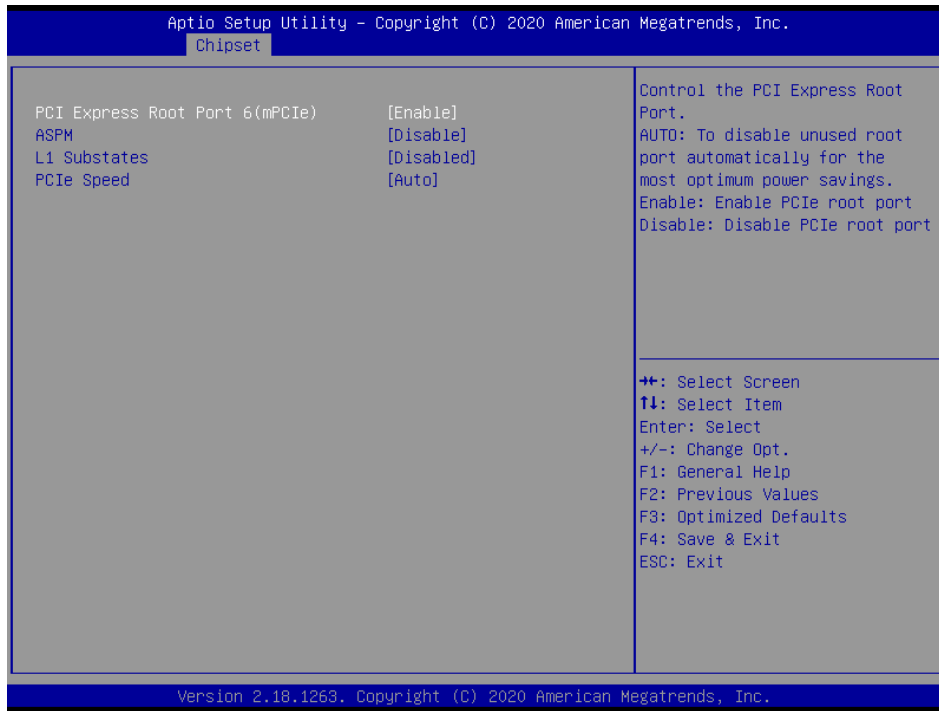

| Item | Option | Description |
|---------------------------------------|---|---|
| PCI Express Root Port 6(mPCIe) | Disable Enable[Default] | Control the PCI Express Root Port. AUTO: To disable unused root port automatically for the most optimum power savings. Enable: Enable PCIe root port Disable: Disable PCIe root port. |
| ASPM | Disable[Default] L0s L1 L0sL1 Auto | PCI Express Active State Power Management settings. |
| L1 Substates | Disabled[Default] L1.1 L1.2 L1.1 & L1.2 | PCI Express L1 Substates settings. |
| PCIe Speed | Auto[Default] Gen 1 Gen 2 | Configure PCIe Speed. |

3.6.3.4.3 SATA Drives

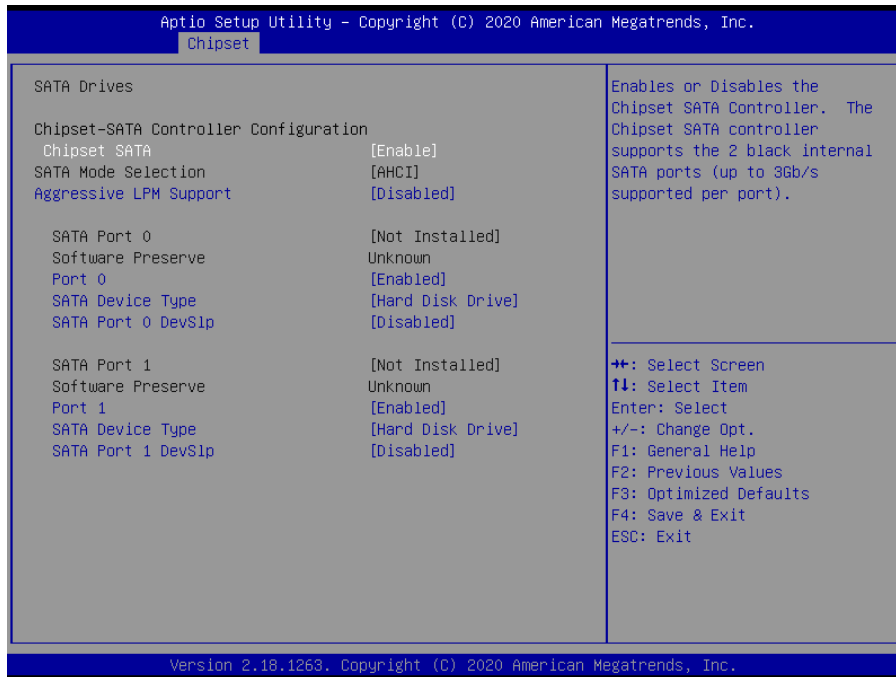

| Item | Option | Description |
|-------------------------------|---|---|
| Chipset SATA | Enable[Default], Disable | Enables or Disables the Chipset the SATA Controller. The Chipset SATA controller supports the 2 black internal SATA ports (up to 3Gb/s supported per port). |
| Aggressive LPM Support | Disabled[Default] Enabled | Enable PCH to aggressively enter link power state. |
| Port 0/1 | Disabled Enabled[Default] | Enable or Disable SATA Port. |
| SATA Device Type | Hard Disk Drive[Default] Solid State Drive | Identify the SATA port is connected to Solid State Driver or Hard Disk Drive. |
| SATA Port 0/1 DevSlp | Disabled[Default] Enabled | Enable/Disable SATA Port 0/1 DevSlp. Board rework for LP needed before enable. |

3.6.3.4.4 SCC Configuration

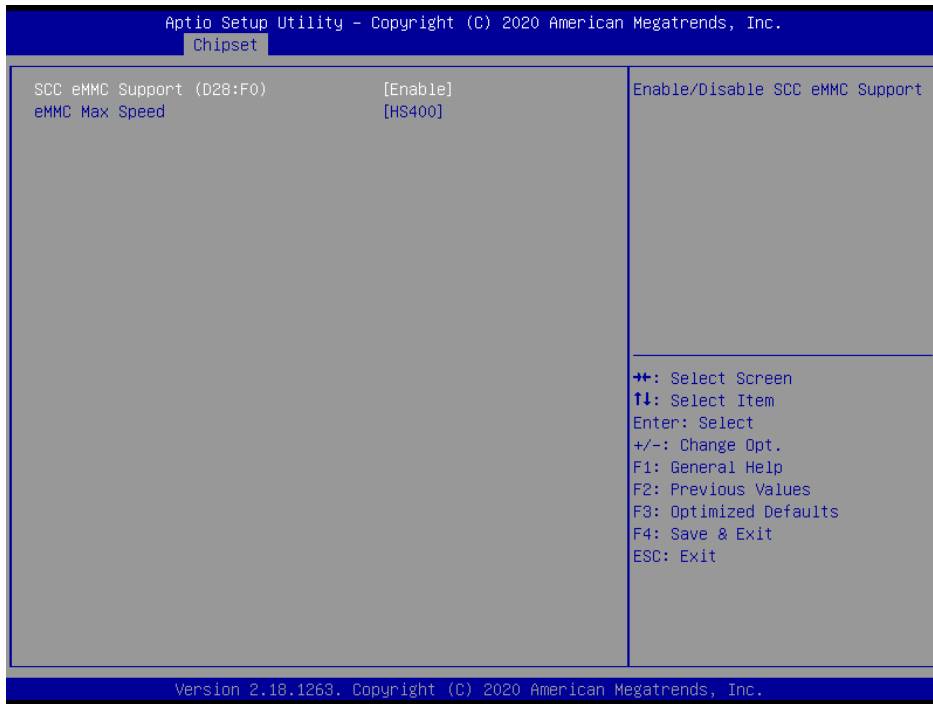

| Item | Option | Description |
|----------------------------------|-----------------------------------|------------------------------------|
| SCC eMMC Support (D28:F0) | Disable Enable[Default], | Enable/Disable SCC eMMC Support. |
| eMMC Max Speed | HS400[Default], HS200 DDR50 | Select the eMMC max Speed allowed. |

3.6.3.4.5 USB Configuration



| Item | Option | Description |
|----------------------|--------------------------|--|
| XHCI Pre-Boot Driver | Enable, Disable[Default] | Enable/Disable XHCI Pre-Boot Driver support. |

3.6.4 Security

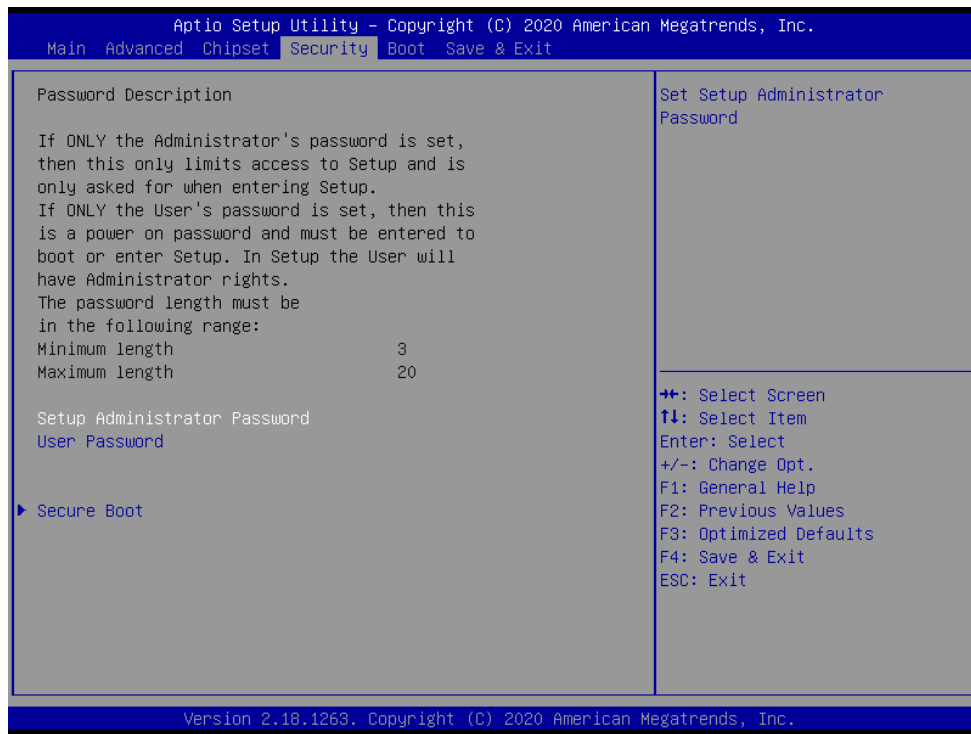

- **Setup Administrator Password**

Set setup Administrator Password

- **User Password**

Set User Password

3.6.4.1 Secure Boot

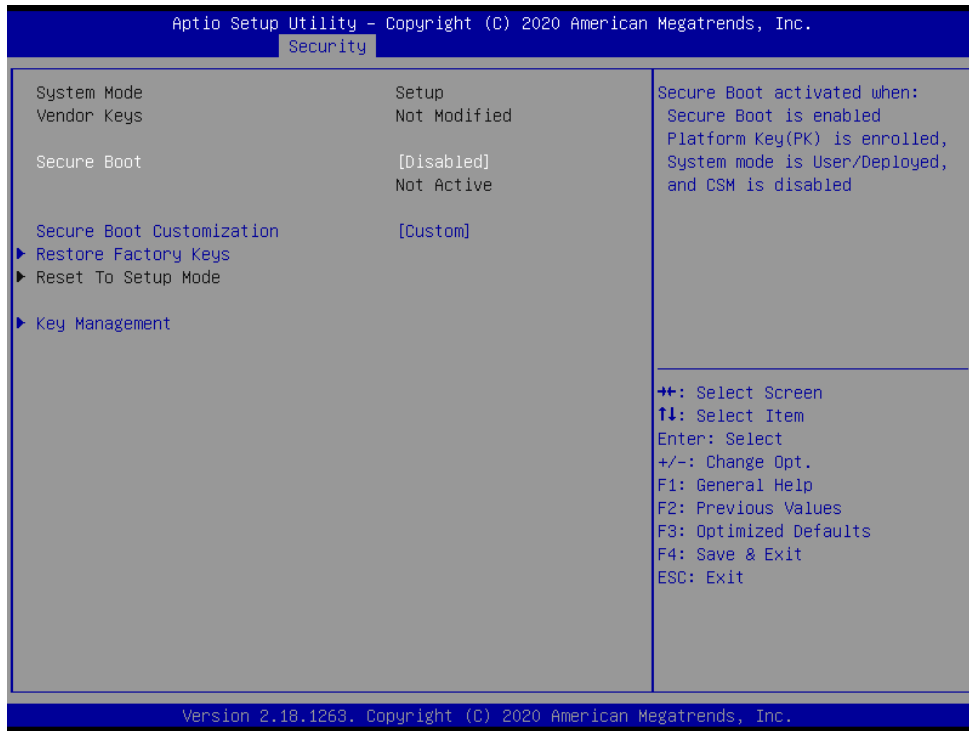

| Item | Option | Description |
|----------------------------------|------------------------------|--|
| Secure Boot Mode | Disabled[Default] Enabled | Secure Boot activated when:Secure Boot is enabled, Platform Key(PK) is enrolled, System mode is User/Deployed, and CSM is disabled. |
| Secure Boot Customization | Standard Custom[Default] | Secure Boot Mode –Custom_Standard, Set UEFI Secure Boot Mode to STANDARD mode or CUSTOM mode or CUSTOM mode, this change is effect after save. And after reset, the mode will return to STANDARD mode. |

3.6.5 Boot

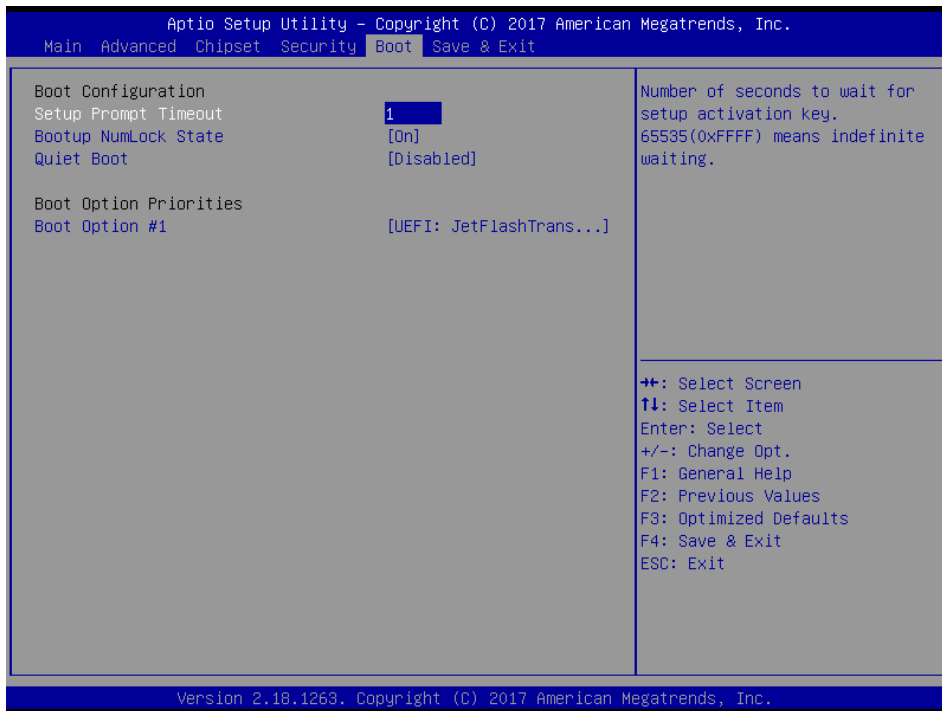

| Item | Option | Description |
|-----------------------------|------------------------------|---|
| Setup Prompt Timeout | 1~ 65535 | Number of seconds to wait for setup activation key. 65535(0xFFFF) means indefinite waiting. |
| Bootup NumLock State | On[Default] Off | Select the Keyboard NumLock state |
| Quiet Boot | Disabled[Default] Enabled | Enables or disables Quiet Boot option |
| Boot Option #1 | Set the system boot order. | |

3.6.6 Save and exit

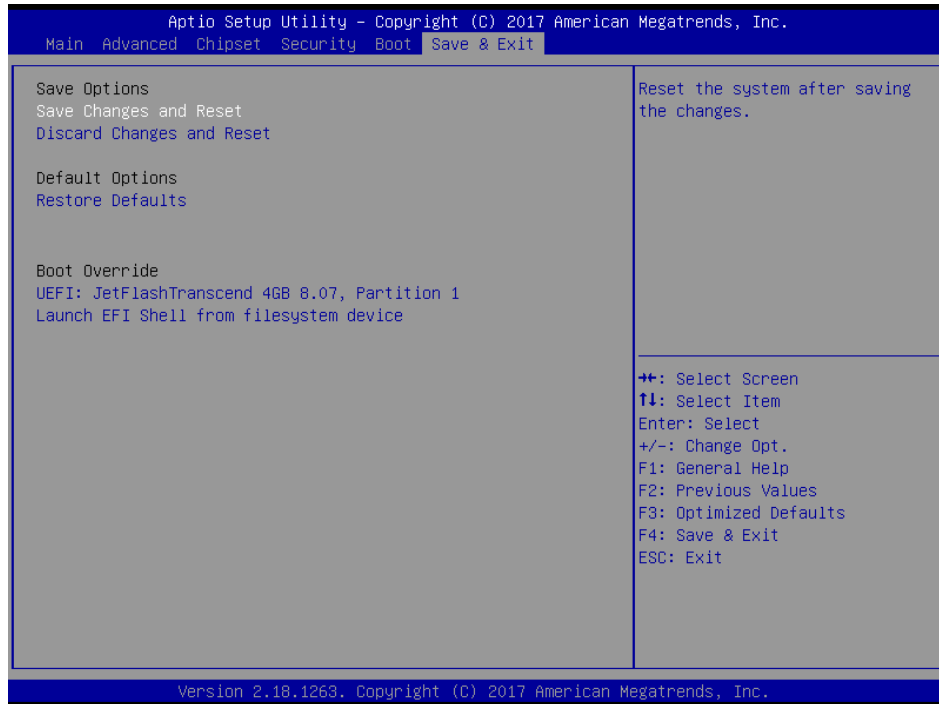

3.6.6.1 Save Changes and Reset

Reset the system after saving the changes.

3.6.6.2 Discard Changes and Reset

Any changes made to BIOS settings during this session of the BIOS setup program are discarded. The setup program then exits and reboots the controller.

3.6.6.3 Restore Defaults

This option restores all BIOS settings to the factory default. This option is useful if the controller exhibits unpredictable behavior due to an incorrect or inappropriate BIOS setting.

3.6.6.4 Launch EFI Shell from filesystem device

Attempts to Launch EFI Shell application (Shellx64.efi) from one of the available filesystem devices.

4. Drivers Installation



Note: Installation procedures and screen shots in this section are for your reference and may not be exactly the same as shown on your screen.

4.1 Install Chipset Driver

All drivers can be found on the Avalue Official Website:

<http://www.avalue.com.tw>.



Note: The installation procedures and screen shots in this section are based on Windows 10 operation system. If the warning message appears while the installation process, click Continue to go on.

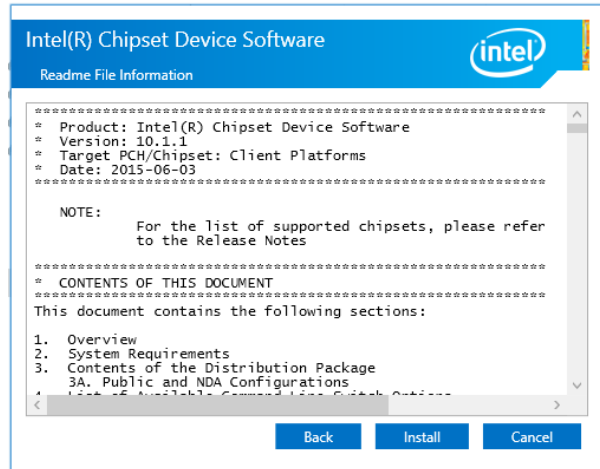

Step 3. Click Install.

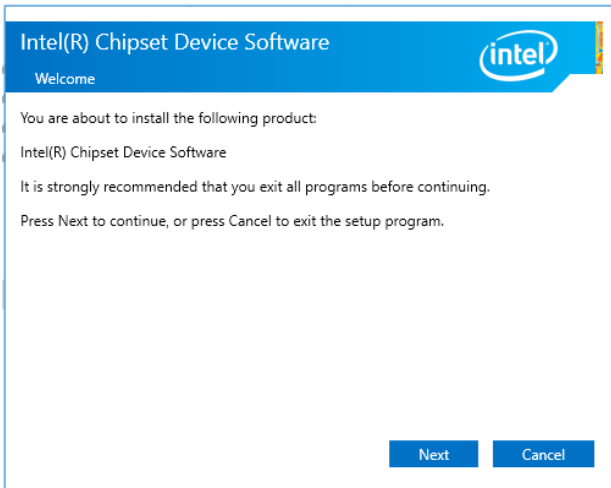

Step1. Click Next.

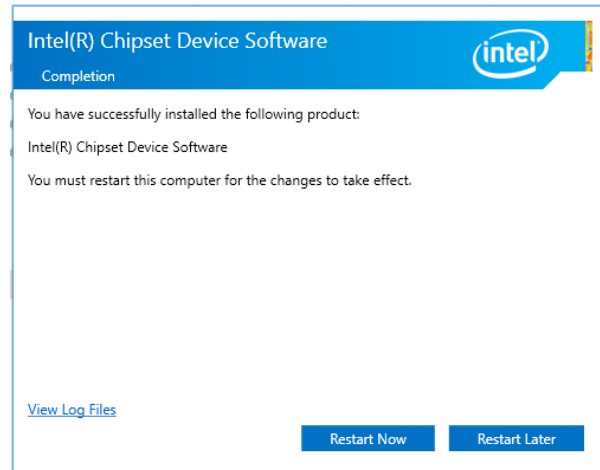

Step 4. Click Finish to complete setup.

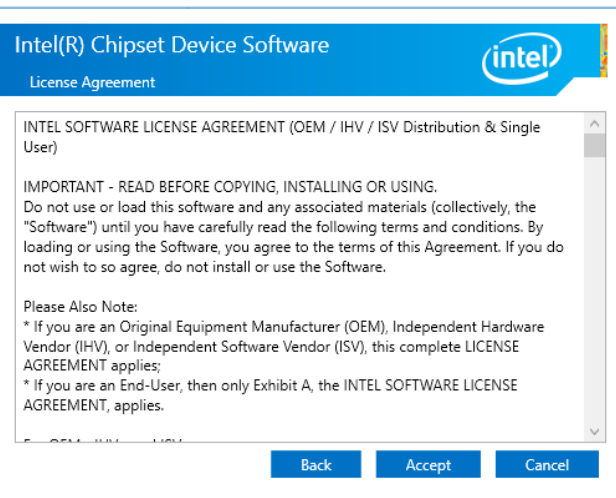

Step 2. Click Accept.

4.2 Install VGA Driver

All drivers can be found on the Avalue Official Website:

<http://www.avalue.com.tw>.



Note: The installation procedures and screen shots in this section are based on Windows 10 operation system. If the warning message appears while the installation process, click Continue to go on.

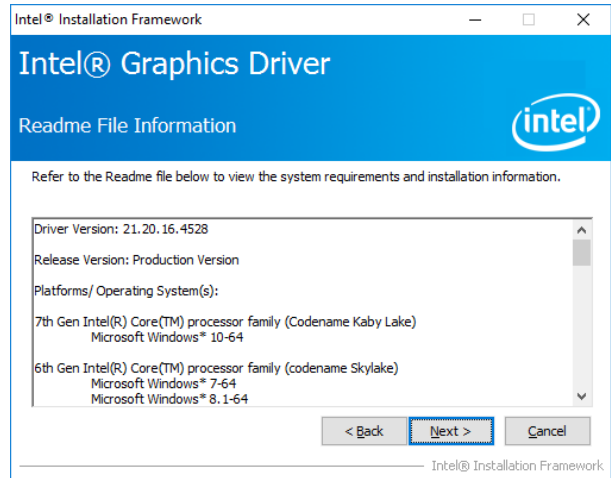

Step 3. Click Next.

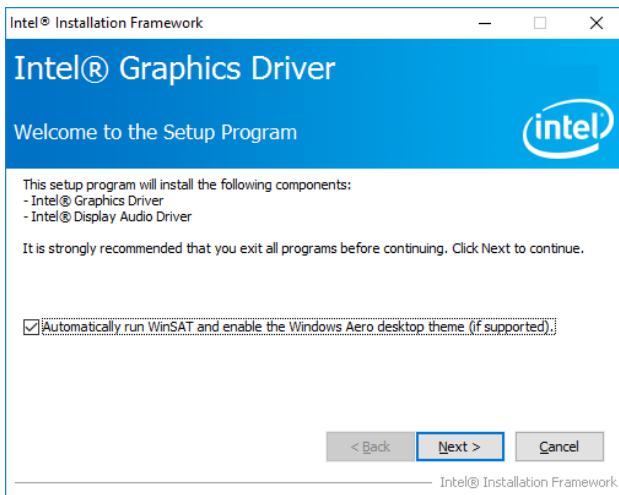

Step 1. Click Next to continue installation.

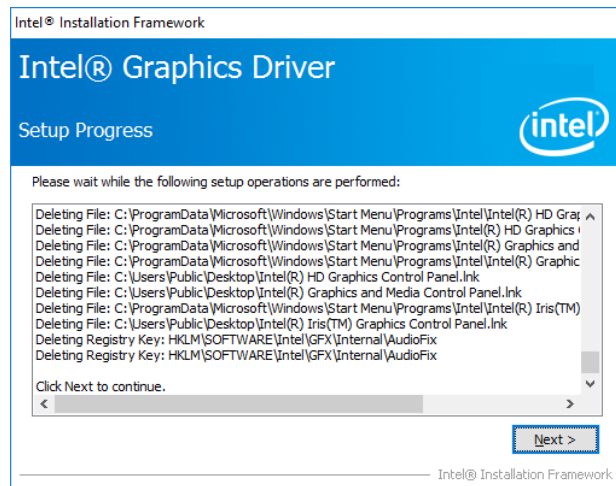

Step 4. Click Next.

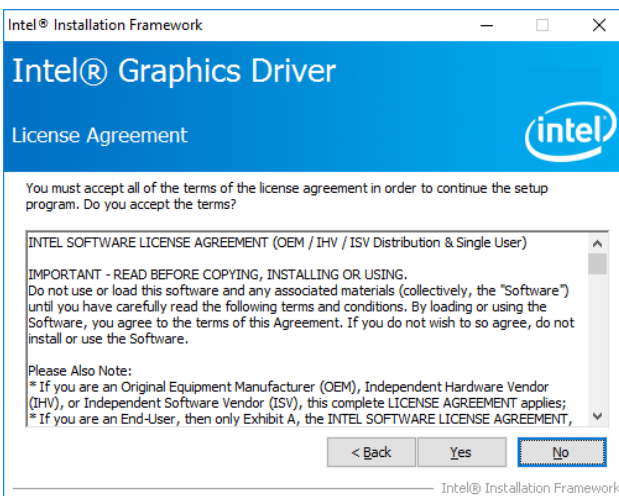

Step 2.

Click **Yes** to accept license agreement.

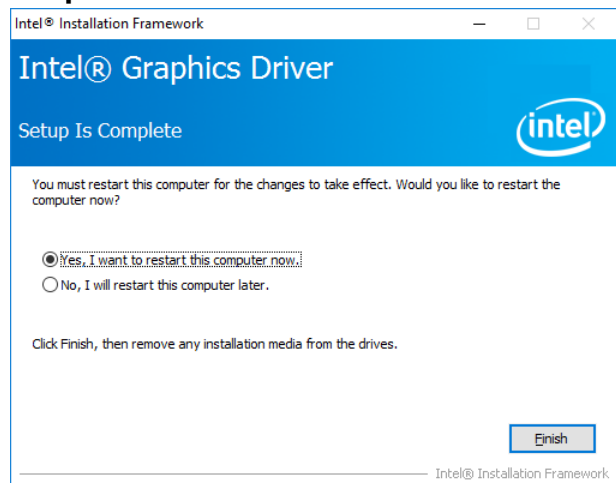

Step 5. Click Finish to complete setup.

4.3 Install Serial IO Driver

All drivers can be found on the Avalue Official Website:

<http://www.avalue.com.tw>.



Note: The installation procedures and screen shots in this section are based on Windows 10 operation system. If the warning message appears while the installation process, click Continue to go on.

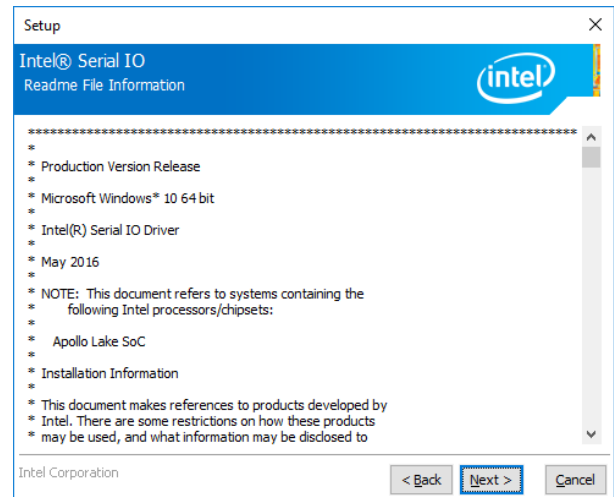

Step 3. Click Next.

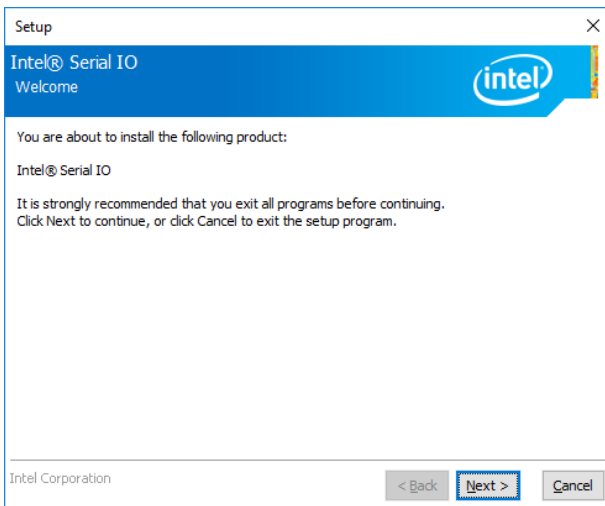

Step 1. Click Next to continue setup.

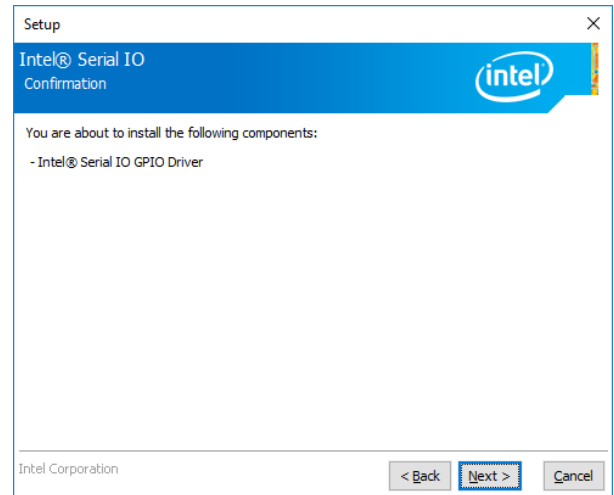

Step 4. Click Next.

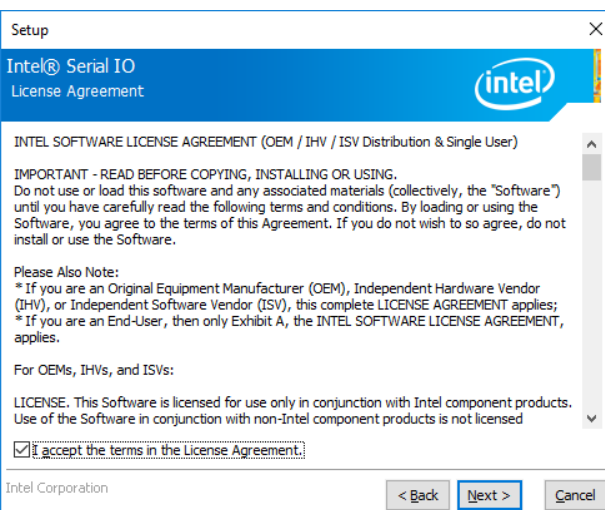

Step 2. Click Next.

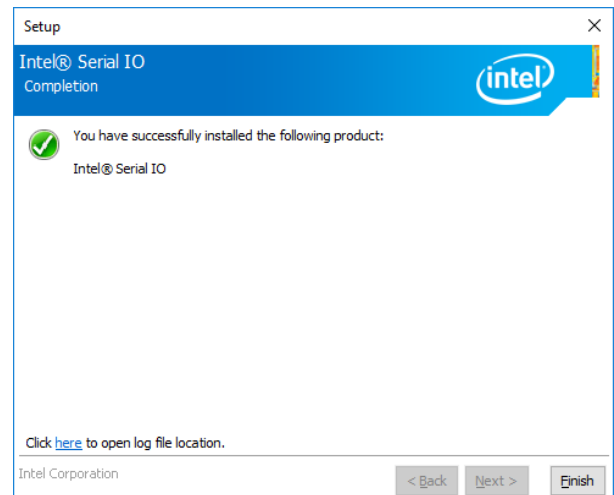

Step 5. Click Finish to complete the setup.

4.4 Install TXE Driver

All drivers can be found on the Avalue Official Website:

<http://www.avalu.com.tw>.



Note: The installation procedures and screen shots in this section are based on Windows 10 operation system. If the warning message appears while the installation process, click Continue to go on.

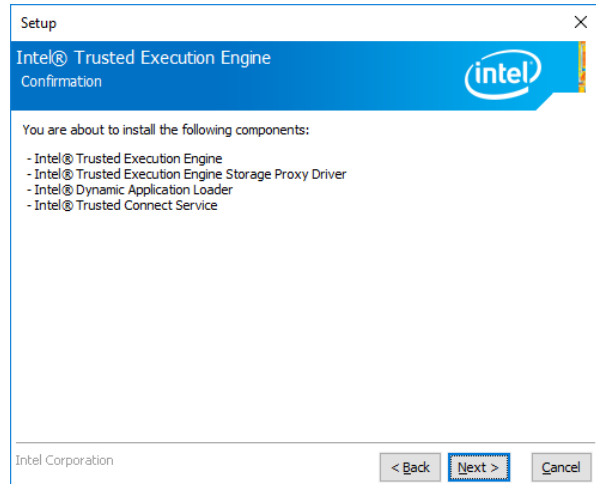

Step 3. Click Next.

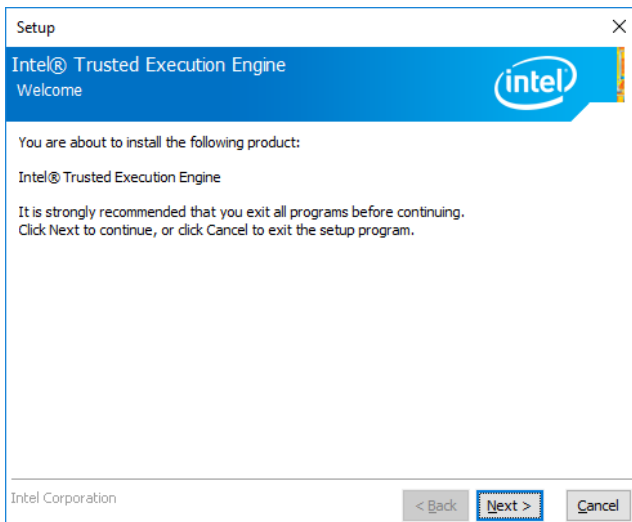

Step 1. Click Next to continue setup.

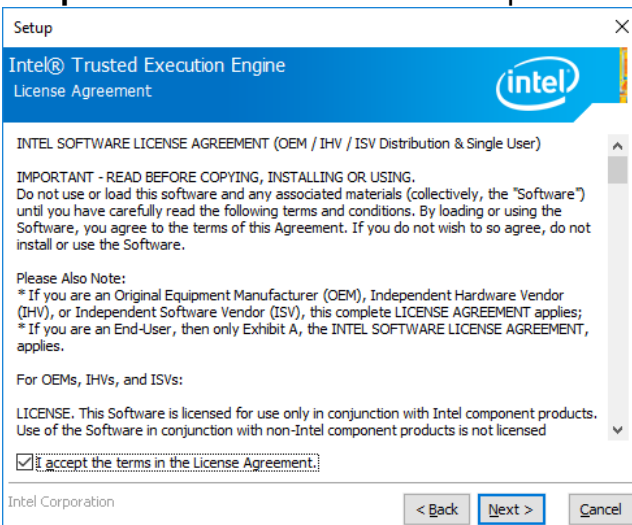

Step 2. Click Next.

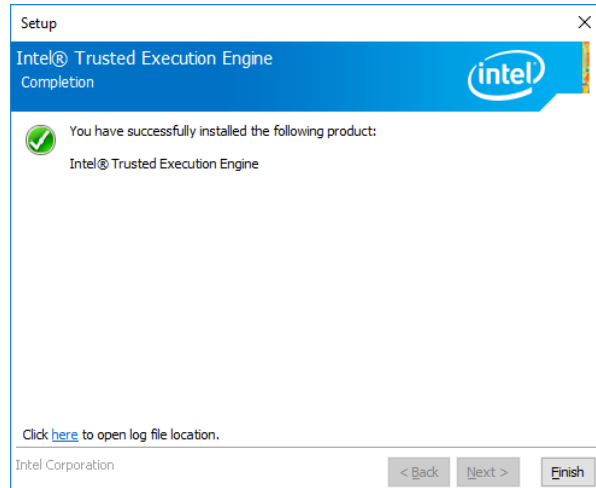

Step 4. Click Finish to complete the setup.

4.5 Install Audio Driver (For Realtek ALC662 HD Audio)

All drivers can be found on the Avalue Official Website:

<http://www.avalue.com.tw>.



Note: The installation procedures and screen shots in this section are based on Windows 10 operation system. If the warning message appears while the installation process, click Continue to go on.

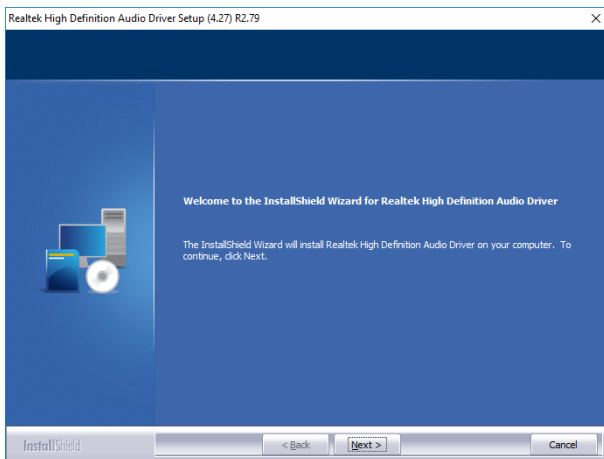

Step 1. Click **Next** to Install.

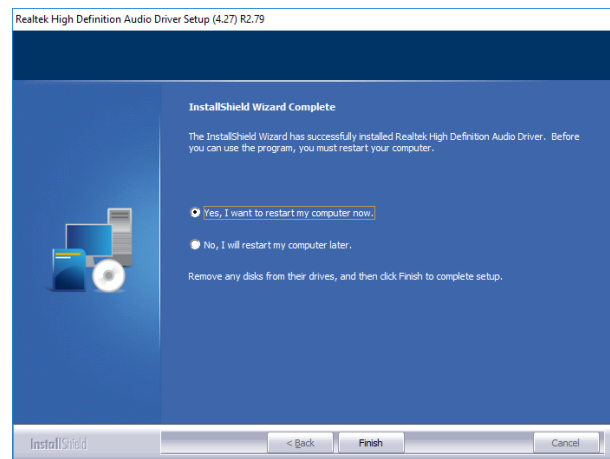

Step 2. Select **Finish** to complete Installation.

4.6 Install LAN Driver (For Intel I211AT)

All drivers can be found on the Avalue Official Website:

<http://www.avalu.com.tw>.



Note: The installation procedures and screen shots in this section are based on Windows 10 operation system. If the warning message appears while the installation process, click Continue to go on.

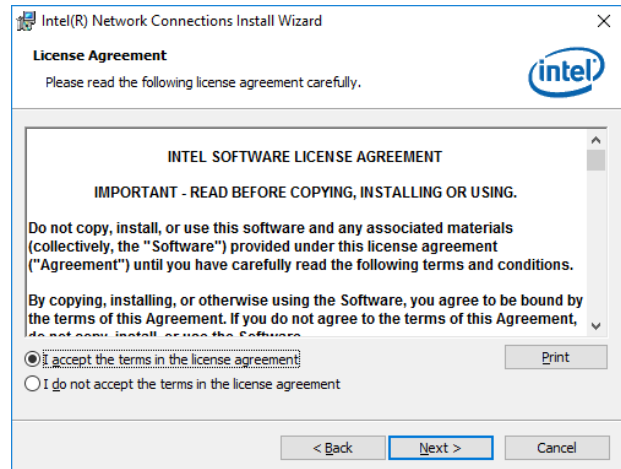

Step 3. Click Next.

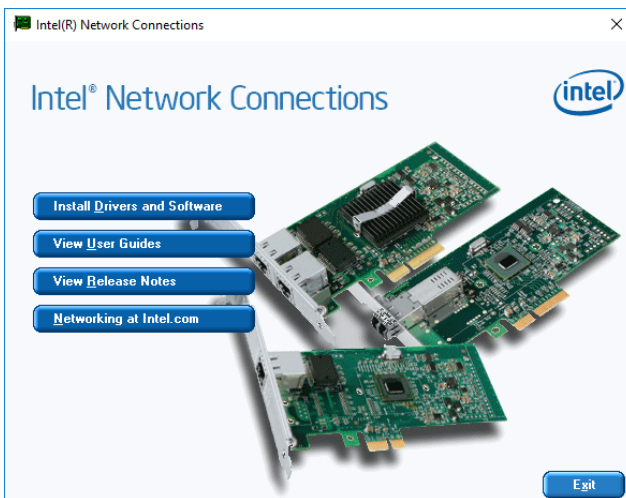

Step 1. Click Install Drivers and Software.

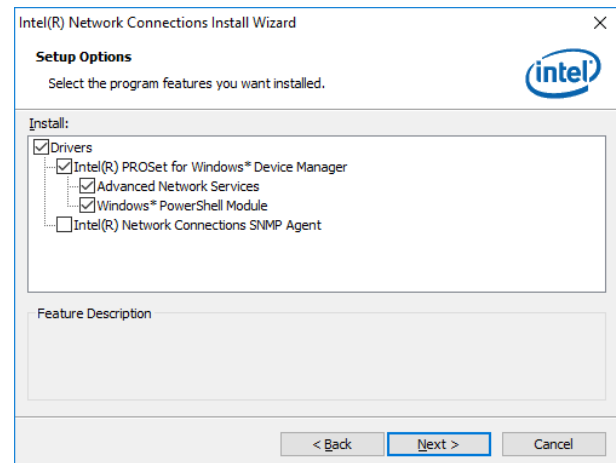

Step 4. Click Next.

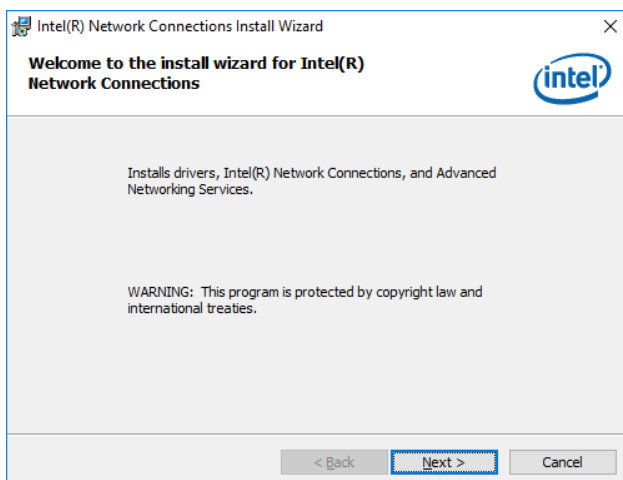

Step 2. Click Next.

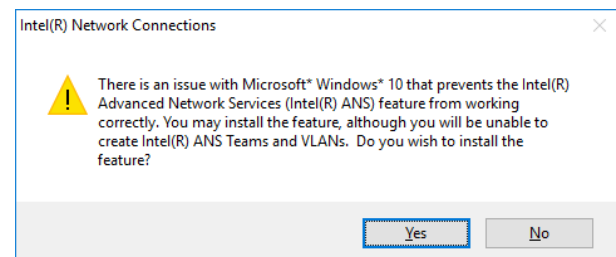

Step 5. Click Yes.

OFP-21W33

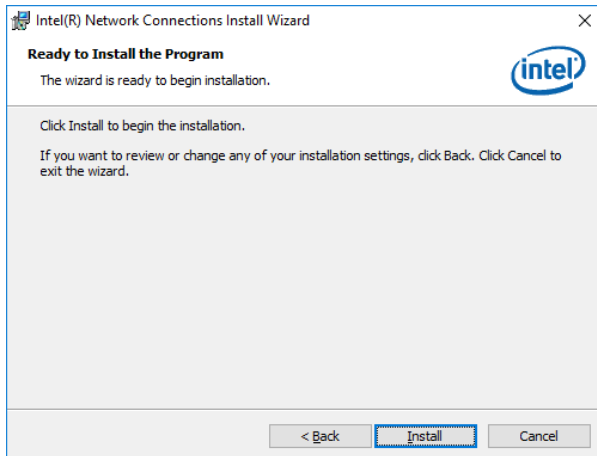

Step 6. Click Install.

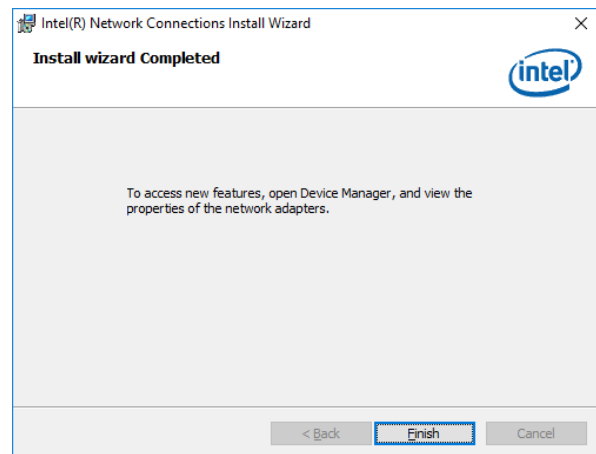

Step 7. Click Finish to complete setup.

5. Development Resource

Here you can find development resource for OFP-21W33

Datasheet

[LCD Datasheet\(LVDS\)](#)

[Touch Screen Datasheet](#)

[Adapter Datasheet](#)

[CE/FCC test Report](#) (Product Design Verification Report)

Here you can find information for Software development

[How to flash Android image file](#)



Note: If you need more information, please visit our website:

<http://www.avalue.com.tw>