

# **P400M9-DMR**

## **Multi-mode PoC Radio**

Cortex-A73 + Cortex-A53 (Octa-core up to 2.0 GHz)

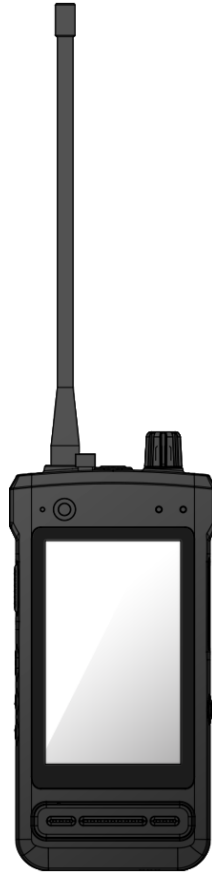

---

# **Quick Start Guide**

## 1. Getting Started

Congratulations on purchasing Winmate® Multi-mode PoC Radio P400M9-DMR.

P400M9-DMR is a multi-mode push to talk over cellular (PoC) radio with robust features designed to bridge the communications gap between diverse radio networks while withstanding industrial use and providing high-tech solutions. The processing power comes from the Cortex-A73 + Cortex-A53 (Octa-core up to 2.0 GHz) processor for high performance. The radio features a 4-inches panel with direct optical bonding and supports DMR also optional VHF/UHF radio.

### Highlights

- Cortex-A73 + Cortex-A53 (Octa-core up to 2.0 GHz)
- 4" 800 x 480 Panel with direct optical bonding
- Supports Android 11
- Support DMR and optional VHF / UHF Radio

## 2. Unpacking

Check and identify the standard supplied accessories.

### Standard factory shipment list:

- **Multi-mode PoC Radio**

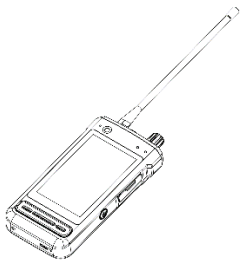

- **Standard Battery**



- **Power Adapter**



- **Quick Start Guide**



### 3. Description of Parts

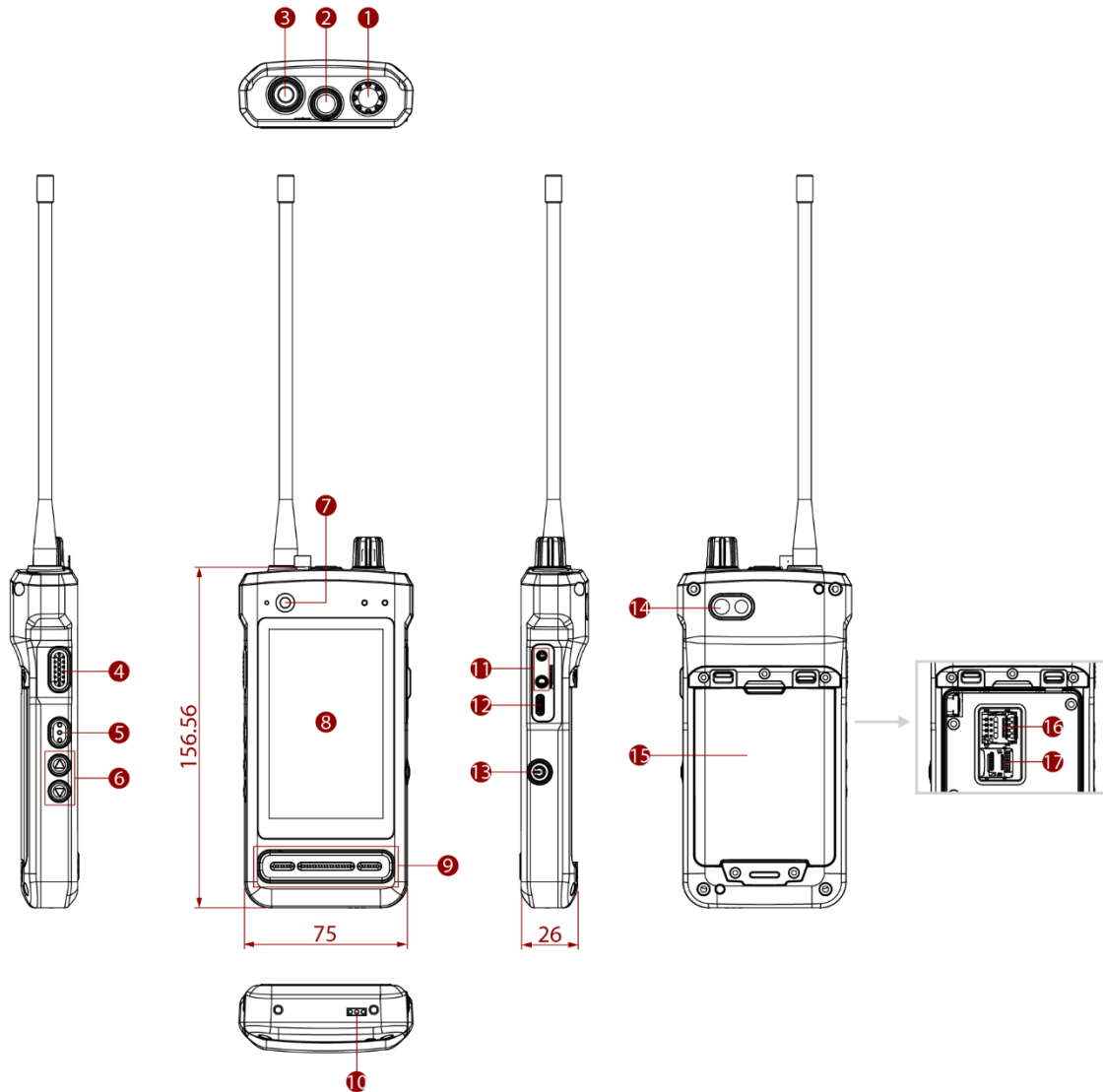

No	Item	Description	No	Item	Description
1	Adjusting Knob	Adjust Radio frequency	10	Docking Connector	Connect to desk docking
2	Emergency Button	Send SOS message	11	Audio Jack	Connect to a K-type headset or headphone
3	Radio Antenna	UHF/VHF Antenna	12	USB Type C	For data transfer and charging
4	PTT Button	Press and hold to speak during half-duplex calls	13	Power Button	Turn on/off the device
5	Function Button	Programmable button. Default: Menu	14	Rear Camera	13MP Autofocus Camera.
6	Volume Buttons	Increase and decrease volume	15	Battery	7.6V, typ. 2500mAh Li-Polymer
7	Front Camera	8 Megapixel Webcam	16	SIM Card Slot	Slot to insert Micro SIM card.
8	4" Touch Screen	Display and act as one of the inputs for the PoC Radio	17	MicroSD Card Slot	Memory card reader port for SD Card
9	Speaker	Send out the voice from the device			

## 4. First-Time Operation

### Attaching the Antenna

1. Put the antenna on the antenna connector.
2. Rotate the antenna clockwise until hand tight.



#### Caution

Do not hold the radio by the antenna. It may reduce the radio performance and antenna's life span.

### Inserting Battery Pack



**Warning!** Discontinue using the device immediately if you notice the battery is swelling or looks puffy or misshapen. Do not attempt to charge or use the device. Do not handle a damaged or leaking battery. Do not let leaking battery fluid come into contact with your eyes, skin, or clothing.



**Caution** To keep battery health and prevent possible issues from battery over-discharged, please charge the device's built-in backup battery once every two months.

*To install the standard battery pack:*

1. Disconnect any cords connected to the PoC radio and turn the radio over, back facing up.
2. Locate the Battery Lock Latch and push it to the "Unlocked" position.
3. Insert the battery with the connector-pins side first, and then lower the battery into the battery compartment. The battery will be flat against the housing once fully inserted.
4. Slide the Battery Lock to the "Locked" position.

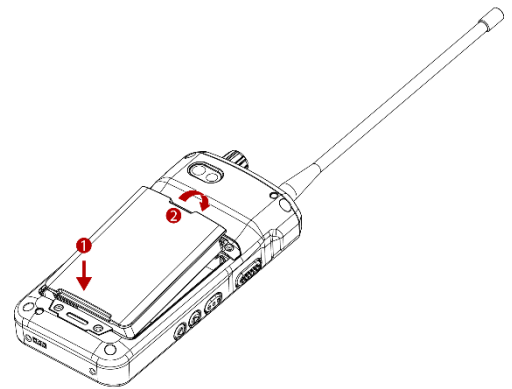

*To remove the battery pack:*

1. Shut down the radio. Disconnect any cords connected to the device.
2. Turn the PoC radio over, back facing up.
3. Locate the Battery Lock and slide it to the "Unlocked" position.
4. Lift the battery out of the compartment.

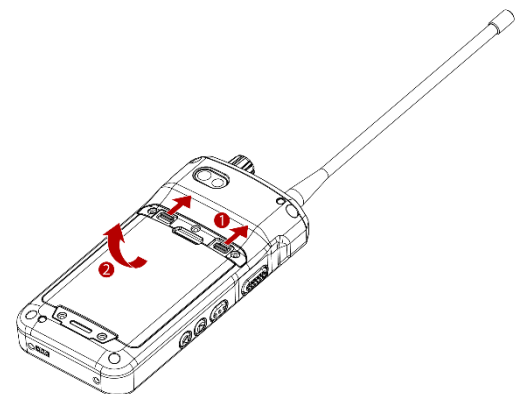

### Installing SIM-Card

*To install the SIM card:*

1. Remove the battery, as described in the section *Inserting Battery Pack*.
2. Push and lift the SIM-card slot.
3. Insert the SIM card into the SIM-card slot. **Chip/contact is facing down.**
4. Push the SIM-Card slot back to the original position.
5. Put the battery back.

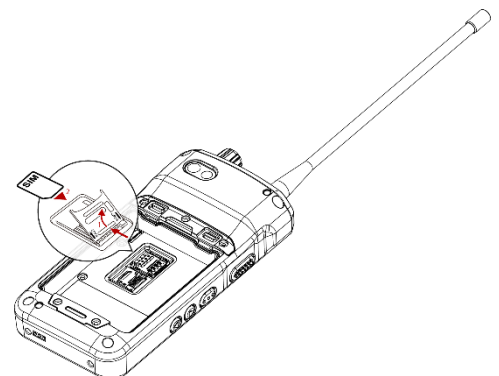

## Inserting MicroSD Card

To install MicroSD Card:

1. Remove the battery, as described in the section *Inserting Battery Pack*.
2. Push and lift the microSD-card slot.
3. Insert microSD card into slot. **Chip/contact is facing down.**
4. Close the microSD card holder.
5. Put back the battery, as described in the section *Inserting Battery Pack*.

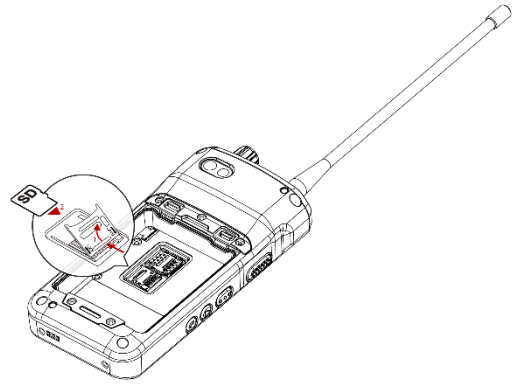

## Connecting to Power Supply

The PoC radio operates either on external AC power or internal battery power. It is recommended to use AC power when you start up the radio for the first time.



**Caution** Use only the AC adapter included with your device. Using other AC adapters may damage the device and the Battery.



**Caution** Please ensure the battery has fully charged before starting up the device for the first time.

Perform the following to connect the Tablet computer to AC Power:

1. Open I/O protective cover by pulling out the latch.
2. Plug the USB Type C of the power adapter into the USB Type C port of the device.
3. Plug the power cord into the electrical outlet.

## 5. Turning On and Off the Device

### Turning On

1. Press and hold the power button on the right side of the unit for **3 seconds**.
2. When the device vibrates, release the power button.
3. The desktop screen is displayed.

### Turning Off

1. Press and hold the power button until the phone options menu appears, tap the **Power Off**  .
2. Users can also use the Phone options menu to put the device into silent or airplane mode.

## 6. Radio Setting

### Using Radio and PoC Functions

1. In the main APPS window, open the Larzio app and log in. Select any person/group in the address book to enter the call page.

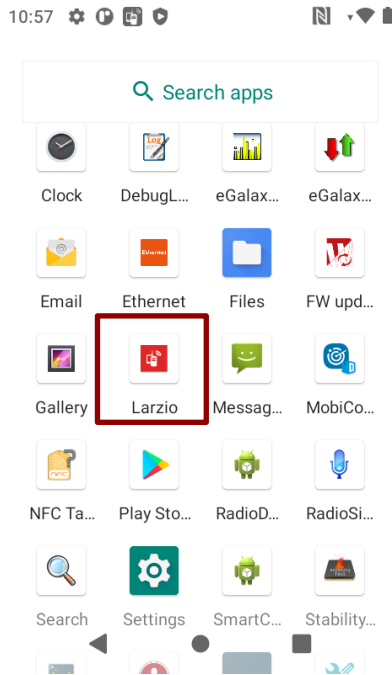

2. There are two ways to switch between PoC and Radio mode:
  - On the call page, slide the modes button to switch between PoC or radio modes.

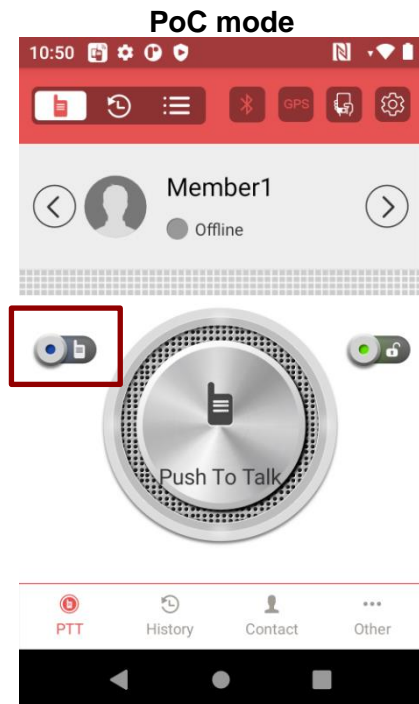

- Or Click **Other** > **Radio Mode** to enter the radio mode.

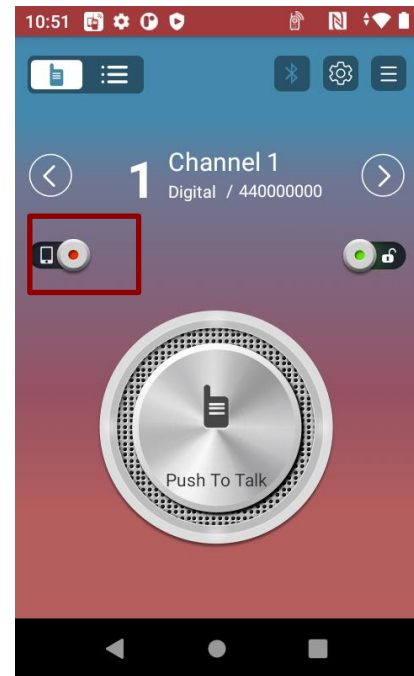
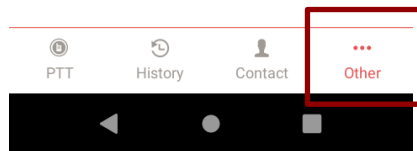
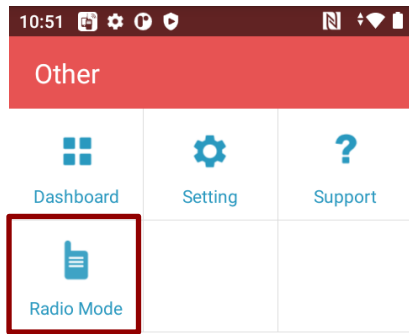

## Switch Channels

The Larzio App can store 16 channels for quick switching between calls.

1. Rotate the adjusting knob or click the left/right arrow buttons to switch channels.



2. Click the **Channel List** icon. Then click the channel list to switch between channels.

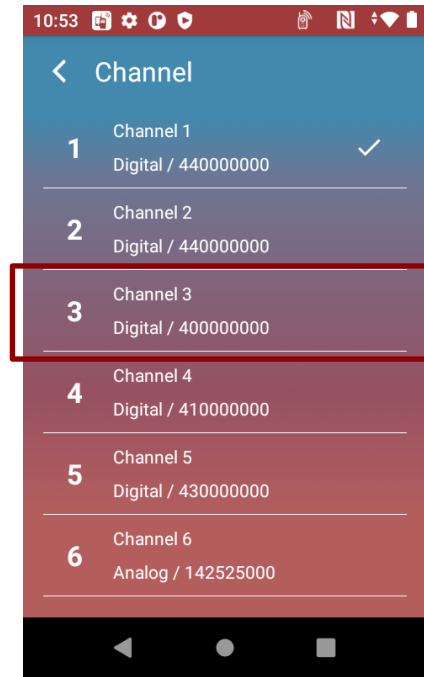
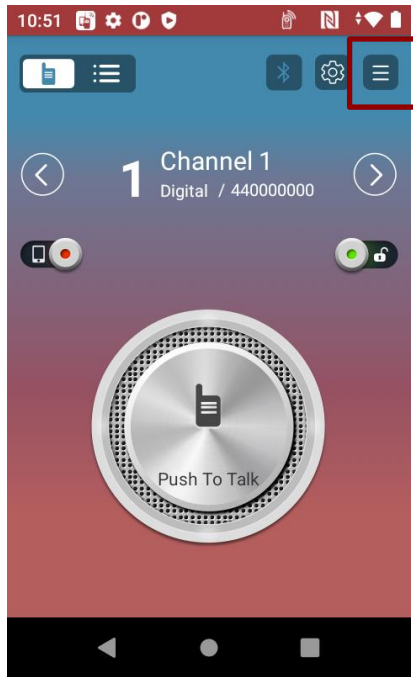

## Edit Channels

1. Click the **List** icon to view information about the current channel.
2. Click the **Edit Channel** and then click the items to be modified.
3. After editing, press the **Save Settings** to complete the modification.

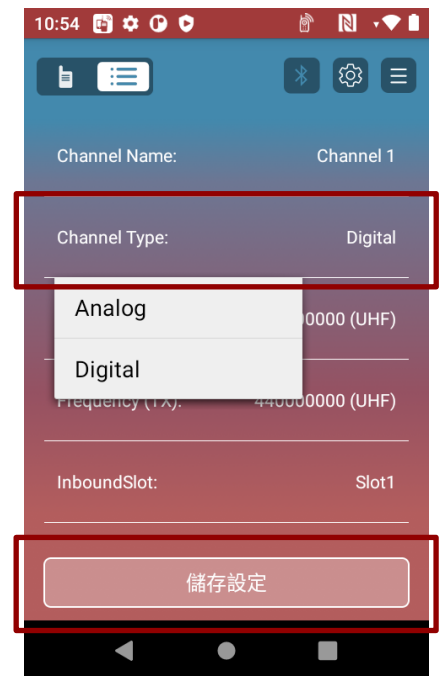
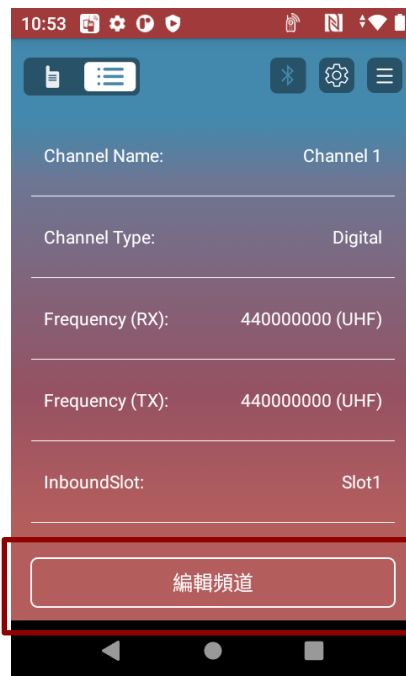
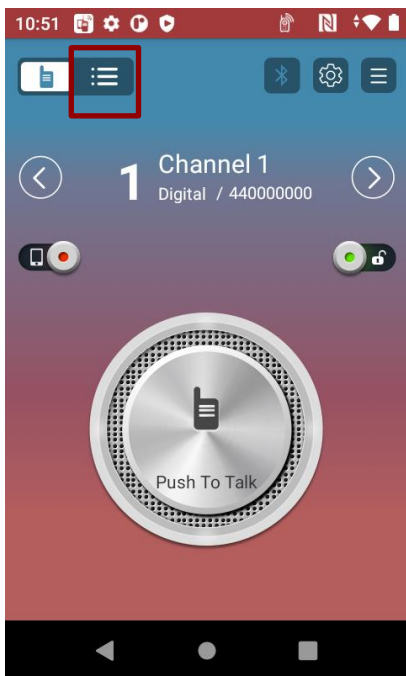



## Parameter Setting

Click the **Setting** icon to set general parameters for all channels.

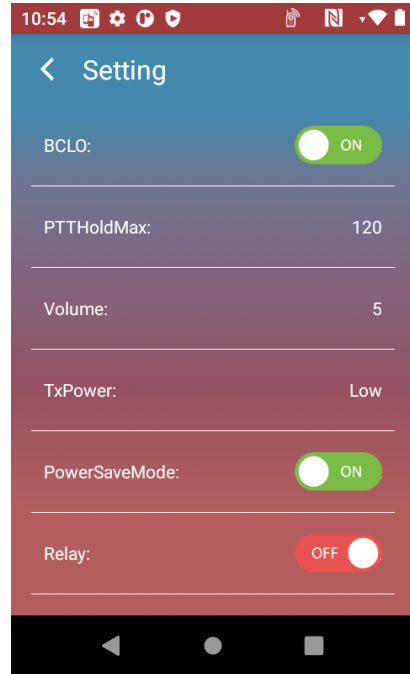
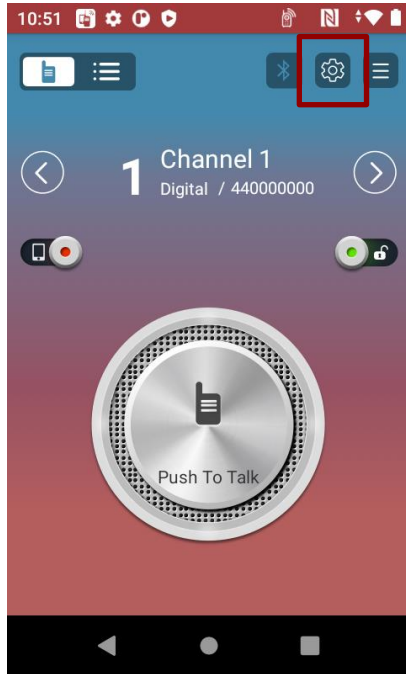

## Push to Talk

Press and hold the **Push To Talk** on the screen or the PTT button on the left side of the device to speak during half-duplex calls.

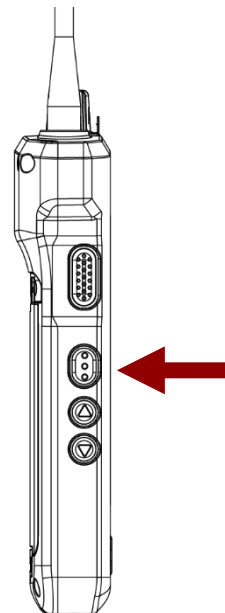

## 7. Winmate Kiosk Manager

The P400M9-DMR Multi-mode PoC radio comes with preinstalled APP named Winmate® Home Manager (WKM). This application lets the device manager lock the launcher. When the launcher is locked, the user can only use one application assigned by the device manager.

1. In the main APPS window, select the **Kiosk Manager** . Select **Kiosk Manager** to start your settings. Go to **Password Manager** and set your password for this APP. The default password: **password**

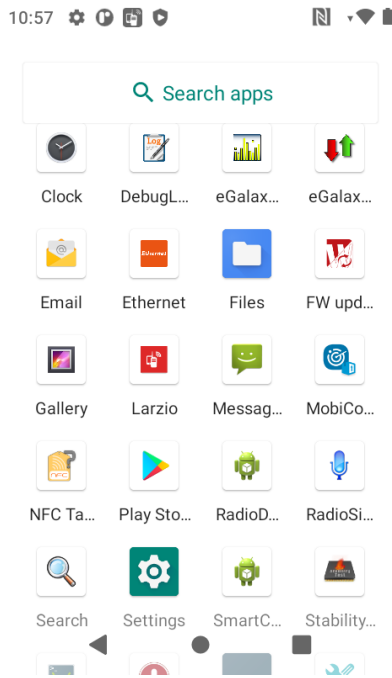

Refer to the *User Guide* for more details about Winmate Kiosk Manager.



---

Winmate Inc.  
9F, No.111-6, Shing-De Rd., San-Chung District,  
New Taipei City 24158, Taiwan, R.O.C  
[www.winmate.com](http://www.winmate.com)

