

# M Series Box PC

**Intel® Tiger Lake Core™ i5-1135G7, 2.4 GHz  
(turbo up to 4.2GHz)**



**Model No.:** ITMH100  
ITMH100-6L  
ITMH200

---

# User Manual

Version 1.0

Document Part No: 915211101100

Please read these instructions carefully before using this product, and save this manual for future use.

# CONTENTS

<b>Preface</b> .....	<b>3</b>
<b>Chapter 1: Introduction</b> .....	<b>6</b>
1.1 Features .....	6
1.2 Package Contents .....	7
1.3 Product Overview .....	8
1.3.1 I/O Connectors – ITMH100 .....	8
1.3.2 I/O Connectors – ITMH100-6L .....	8
1.3.3 I/O Connectors – ITMH200 .....	9
1.4 Dimensions.....	10
1.4.1 ITMH100 .....	10
1.4.2 ITMH100-6L.....	10
1.4.3 ITMH200 .....	11
<b>Chapter 2: Installation</b> .....	<b>12</b>
2.1 Mounting.....	12
2.1.1 VESA Mount .....	12
2.1.2 Desk Mount (ITMH200 only) .....	12
2.2 Service Access (ITMH100 only) .....	13
2.3 Connecting the Power .....	15
2.4 Connector Pin Define .....	16
2.4.1 Isolated DC in Connector .....	16
2.4.2 Giga LAN Connector .....	16
2.4.3 USB 3.2 Gen 1 Connector .....	16
2.4.4 HDMI Output Connector.....	16
2.4.5 DP Output Connector .....	17
2.4.6 Serial Port Connector .....	17
2.4.7 Giga LAN Connector .....	17
2.4.8 Audio Combo Connector (Mic in/ Line Out) .....	17
<b>Chapter 3: Getting Started</b> .....	<b>18</b>
<b>Chapter 4: BIOS Setting</b> .....	<b>39</b>
4.1 How and When to Use BIOS Setup.....	39
4.2 BIOS Functions .....	40
4.2.1 Main Menu .....	40
4.2.2 Boot .....	41
4.2.3 Serial Port Mode Settings: RS232, RS485, RS422 .....	42
<b>Chapter 5: Specifications</b> .....	<b>44</b>
<b>Appendix</b> .....	<b>46</b>

Appendix A: System Dimensions ..... 46  
Appendix B: Software Developer Support ..... 47

# Preface

## Advisory Conventions

Four types of advisories are used throughout the user manual to provide helpful information or to alert you to the potential for hardware damage or personal injury. These are Notes, Important, Cautions, and Warnings. The following is an example of each type of advisory.



**Note:**

A note is used to emphasize helpful information



**Important:**

An important note indicates information that is important for you to know.



**Caution** A Caution alert indicates potential damage to hardware and explains how to avoid the potential problem.



**Warning!** An Electrical Shock Warning indicates the potential harm from electrical hazards and how to avoid the potential problem.

## FCC Statement

This device complies with part 15 FCC rules.



Operation is subject to the following two conditions:

- This device may not cause harmful interference.
- This device must accept any interference received including interference that may cause undesired operation

This equipment has been tested and found to comply with the limits for a class "B" digital device, pursuant to part 15 of the FCC rules. These limits are designed to provide reasonable protection against harmful interference when the equipment is operated in a commercial environment. This equipment generates, uses, and can radiate radio frequency energy and, if not installed and used in accordance with the instruction manual, may cause harmful interference to radio communications. Operation of this equipment in a residential area is likely to cause harmful interference in which case the user will be required to correct the interference at his own expense.

## CE Notice (European Union)



Electromagnetic Compatibility Directive (2014/30/EU)

- EN55024: 2010/ A1: 2015
  - IEC61000-4-2: 2009
  - IEC61000-4-3: 2006+A1: 2007+A2: 2010
  - IEC61000-4-4: 2012
  - IEC61000-4-5: 2014
  - IEC61000-4-6: 2014
  - IEC61000-4-8: 2010
  - IEC61000-4-11: 2004

- EN55032: 2012/AC:2013

- EN61000-3-2:2014

- EN61000-3-3:2013

Low Voltage Directive (2014/35/EU)

- EN 60950-1:2006/A11:2009/A1:2010/A12:2011/ A2:2013

This equipment is in conformity with the requirement of the following EU legislations and harmonized standards. Product also complies with the Council directions.

## Copyright Notice

No part of this document may be reproduced, copied, translated, or transmitted in any form or by any means, electronic or mechanical, for any purpose, without the prior written permission of the original manufacturer.

## Trademark Acknowledgement

Brand and product names are trademarks or registered trademarks of their respective owners.

## Disclaimer

Winmate Inc. reserve the right to make changes, without notice, to any product, including circuits and/or software described or contained in this manual in order to improve design and/or performance. We assume no responsibility or liability for the use of the described product(s) conveys no license or title under any patent, copyright, or masks work rights to these products, and make no representations or warranties that these products are free from patent, copyright, or mask work right infringement, unless otherwise specified. Applications that are described in this manual are for illustration purposes only. We make no representation or guarantee that such application will be suitable for the specified use without further testing or modification.

## Warranty

Winmate Inc. warranty guarantees that each of its products will be free from material and workmanship defects for a period of one year from the invoice date. If the customer discovers a defect, we will, at his/her option, repair or replace the defective product at no charge to the customer, provide it is returned during the warranty period of one year, with transportation charges prepaid. The returned product must be properly packaged in its original packaging to obtain warranty service. If the serial number and the product shipping data differ by over 30 days, the in-warranty service will be made according to the shipping date. In the serial numbers the third and fourth two digits give the year of manufacture, and the fifth digit means the month (e. g., with A for October, B for November and C for December).

For example, the serial number 1W22Axxxxxxx means October of year 2022.

## Customer Service

We provide a service guide for any problem by the following steps: First, visit the website of our distributor to find the update information about the product. Second, contact with your distributor, sales representative, or our customer service center for technical support if you need additional assistance.

You may need the following information ready before you call:

- Product serial number
- Software (OS, version, application software, etc.)
- Description of complete problem
- The exact wording of any error messages

In addition, free technical support is available from our engineers every business day. We are always ready to give advice on application requirements or specific information on the installation and operation of any of our products.

## Safety Information

**Warning!** Always completely disconnect the power cord from your chassis whenever you work with the hardware. Do not make connections while the power is on. Sensitive electronic components can be damaged by sudden power surges. Only experienced electronics personnel should open the PC chassis.



**Avertissement!** Toujours débrancher le cordon d'alimentation du châssis lorsque vous travaillez sur celui-ci. Ne pas brancher de connexions lorsque l'alimentation est présente. Des composants électroniques sensibles peuvent être endommagés par des sauts d'alimentation. Seulement du personnel expérimenté devrait ouvrir ces châssis.



**Caution** Always ground yourself to remove any static charge before touching the CPU card. Modern electronic devices are very sensitive to static electric charges. As a safety precaution, use a grounding wrist strap at all times. Place all electronic components in a static-dissipative surface or static-shielded bag when they are not in the chassis.

**Attention** Toujours vérifier votre mise à la terre afin d'éliminer toute charge statique avant de toucher la carte CPU. Les équipements électroniques modernes sont très sensibles aux décharges d'électricité statique. Toujours utiliser un bracelet de mise à la terre comme précaution. Placer toutes les composantes électroniques sur une surface conçue pour dissiper les charges, ou dans un sac anti-statique lorsqu'elles ne sont pas dans le châssis.

# Chapter 1: Introduction

Congratulations on purchasing Winmate® M Series BOX PC. ITMH100/ ITMH200 with 11th Generation Intel® i5-1135G7 offers high performance computing power and outstanding video processing. ITMH100/ ITMH200 are suitable for Factory Automation, Machine Vision, Surveillance and other high-performance applications.

## 1.1 Features

Winmate® ITMH100 Embedded Computer offers the following features:

- Intel® Tiger Lake UP3 Core™ i5-1135G7 rugged Box PC
- Multi Video Output, HDMI/DisplayPort
- Auto detection of the connected display, No settings necessary
- Quick & Easy Replaceable Hard Disk Design, No Tools required
- Support wide range 9-29V DC input
- Optional with Modular front Display as a Panel PC

Winmate® ITMH100-6L Embedded Computer offers the following features:

- Intel® Tiger Lake UP3 Core™ i5-1135G7 processor, rugged Box PC
- Support LAN port x6
- Multi Video Output, HDMI/Display Port
- Quick & Easy Replaceable Hard Disk Design, No Tools required
- Support wide range 9-29V DC input

Winmate® ITMH200 Embedded Computer offers the following features:

- 11th Generation Intel® i5-1145G7 Processors
- Multi Video Output, HDMI/ Display Port
- Support wide range 9-29V DC input Isolation Power
- Auto detection of the connected display, No settings necessary
- Quick & Easily Replaceable Hard Disk Design, No Tools required
- Optional with Modular front Display as a Panel PC Expansion slot for PCIe x4
- One Quick & Easily Removable 2.5" SSD Bay Slot

## 1.2 Package Contents

Carefully remove the box and unpack your device. Please check if all the items listed below are inside your package. If any of these items are missing or damaged contact us immediately.

Standard factory shipment list:

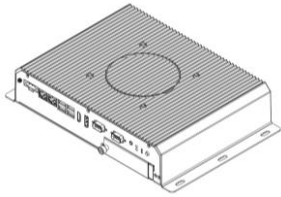

<b>M Series Box PC</b>	<b>Quick Start Guide (Hardcopy)</b>	<b>Driver CD</b>	<b>3 Pin Terminal Block Cable P/N: 94EL02X020E0 Connector P/N: 604520105001</b>
	<b>P/N: 91521110109Z</b>	<b>91711110101U</b>	

Package may include the following items based on your order (optional):

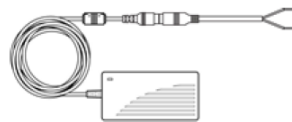
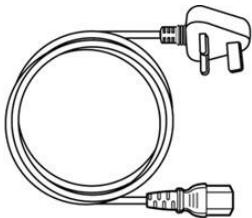

<b>Power Cord</b>	<b>AC Adapter 12V/ 84W</b>
<b>Varies by country</b>	<b>90PO12800000</b>



## 1.3 Product Overview

### 1.3.1 I/O Connectors – ITMH100

Front side I/O

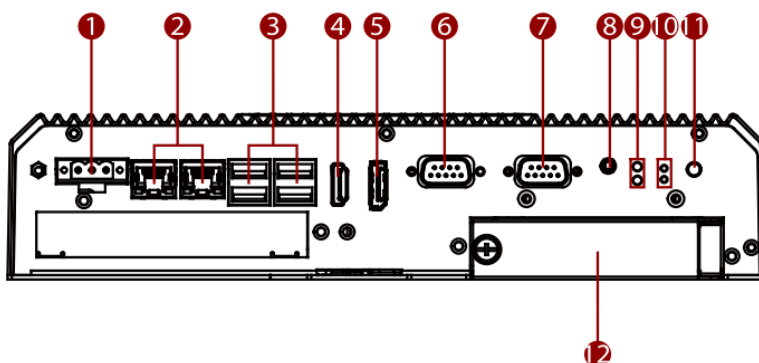

- |                 |  |
|-----------------|--|
| ① Power Input   | ⑧ Audio Combo Connector<br>(Mic in / Line Out) |
| ② Giga LAN      | ⑨ HDD LED indicator                            |
| ③ USB 3.2 Gen.1 | ⑩ Reset / Clear CMOS button                    |
| ④ HDMI          | ⑪ Power Switch                                 |
| ⑤ DP            | ⑫ Removable HDD/ SSD Slot                      |
| ⑥ COM           |  |
| ⑦ COM           |  |

### 1.3.2 I/O Connectors – ITMH100-6L

Front side I/O

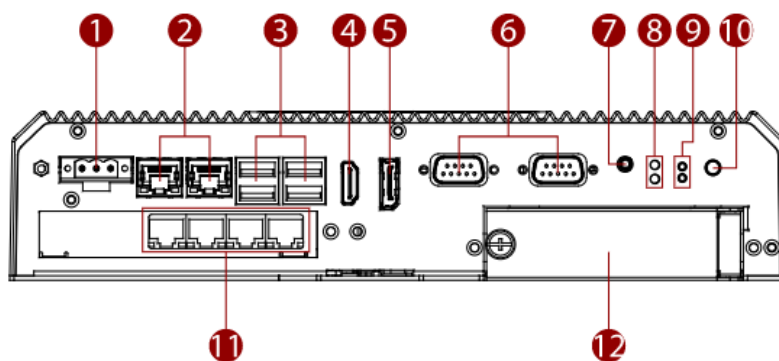

- |                 |                            |
|-----------------|----------------------------|
| ① Power Input   | ⑦ Audio (Mic in/ Line Out) |
| ② Giga LAN      | ⑧ HDD LED indicator        |
| ③ USB 3.2 Gen.1 | ⑨ Reset/ Clear CMOS Button |
| ④ HDMI          | ⑩ Power Switch             |
| ⑤ DP            | ⑪ LAN                      |
| ⑥ COM           | ⑫ Removable HDD/ SSD Slot  |

### 1.3.3 I/O Connectors – ITMH200

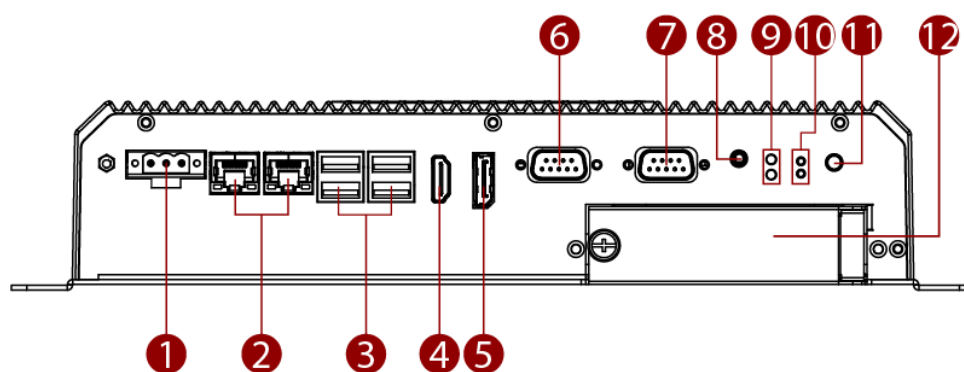

- |                 |                             |
|-----------------|-----------------------------|
| ① Power Input   | ⑦ COM                       |
| ② Giga LAN      | ⑧ Audio (Mic in / Line Out) |
| ③ USB 3.2 Gen.1 | ⑨ HDD LED indicator         |
| ④ HDMI          | ⑩ Reset / Clear CMOS button |
| ⑤ DP            | ⑪ Power Switch              |
| ⑥ COM           | ⑫ Removable HDD/ SSD Slot   |

## 1.4 Dimensions

### 1.4.1 ITMH100

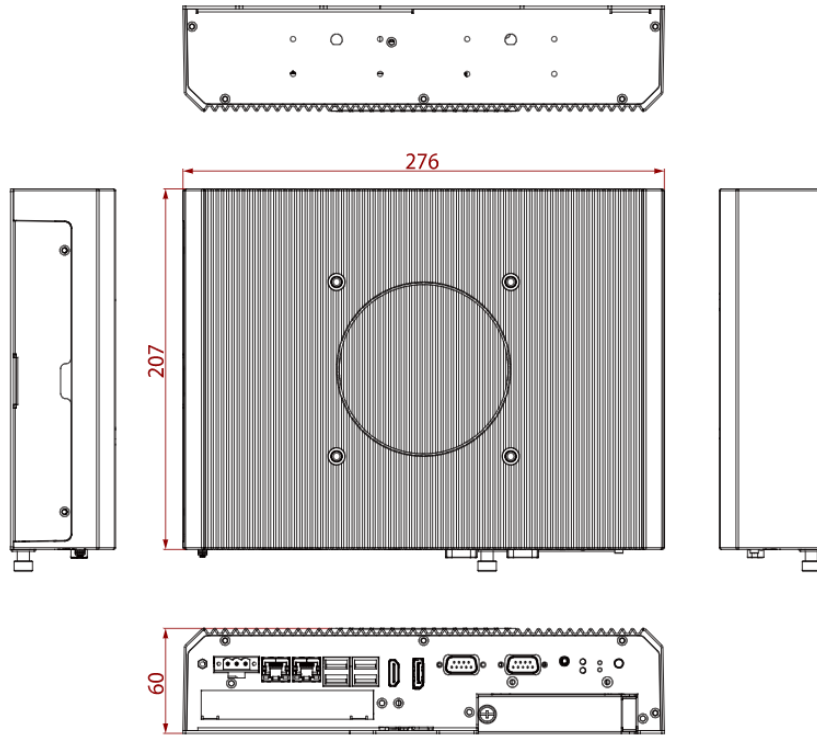

### 1.4.2 ITMH100-6L

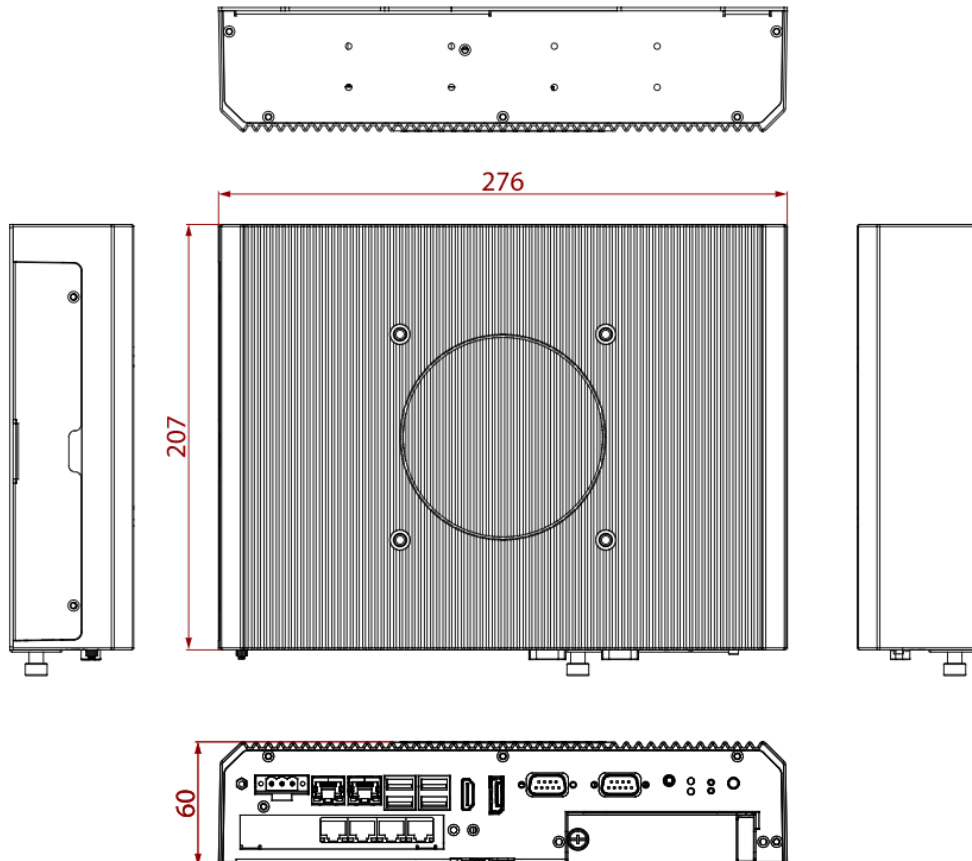

### 1.4.3 ITMH200

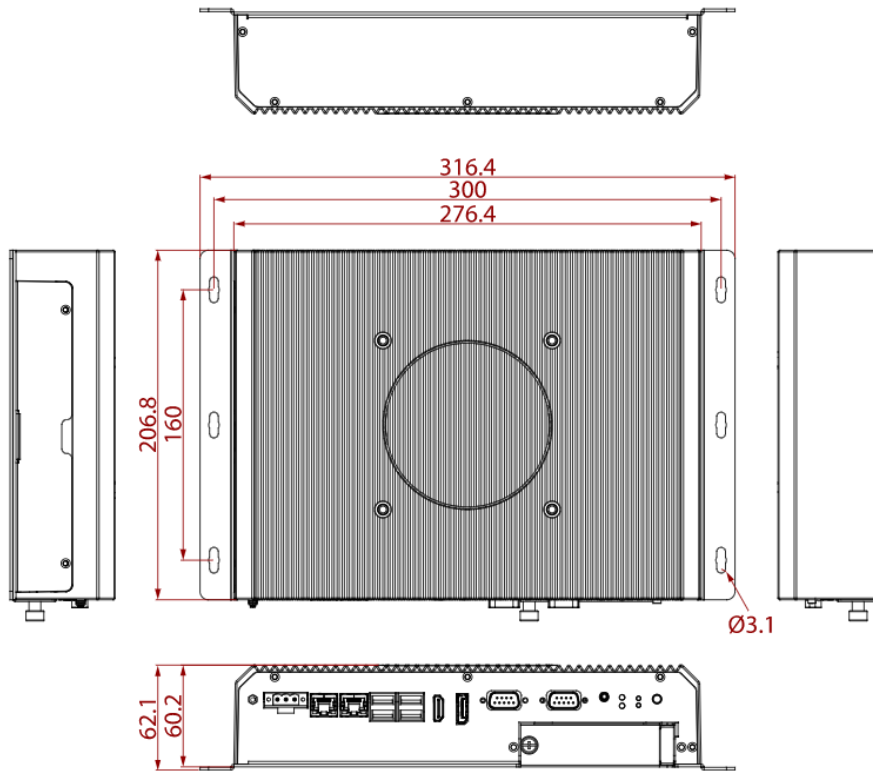

## Chapter 2: Installation

### 2.1 Mounting

#### 2.1.1 VESA Mount

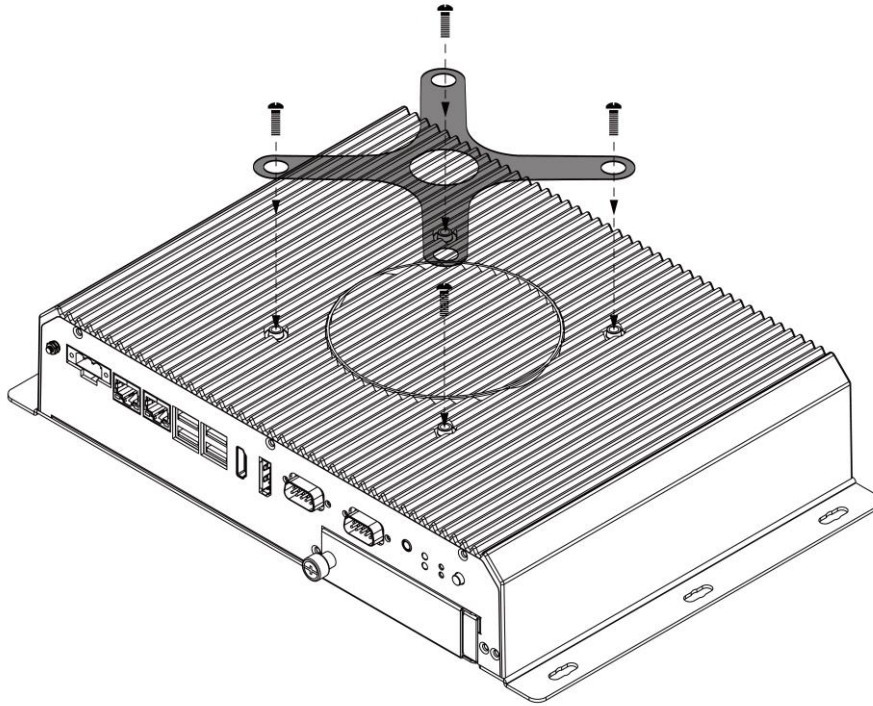

#### **Mounting Instruction:**

1. Fasten screws to secure L-shape mounting brackets to the M SERIES BOX PC.

#### 2.1.2 Desk Mount (ITMH200 only)

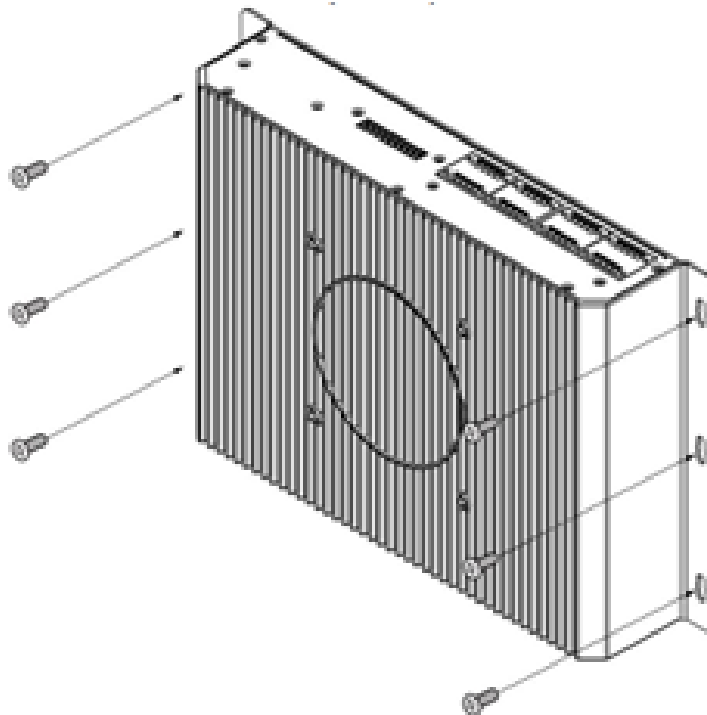

## 2.2 Service Access (ITMH100 only)

ITMH100 Box PC provides Service Access. To access the RAM, internal SSD and PCI Card Slot, do the following steps to perform this task:

1. Turn the box pc over and face the back side



2. Locate the side to access the door. Then, remove the two screws on the side of the box pc



3. Remove the two screws on the bottom side of the box pc



4. User will be able to access the RAM, internal SSD, Fuse, and PCI Card Slot as follows

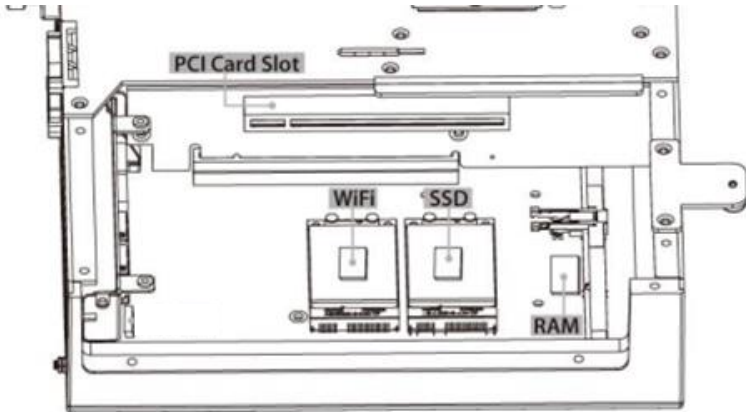

## 2.3 Connecting the Power

### Connecting to AC Power Source

To connect the M Series Box PC to AC power source:

1. Plug one end of the terminal block cable firmly to the DC IN Jack.
2. Plug the other end of the terminal block plug to the AC adapter.
3. Connect the AC adapter to the power cord.
4. Plug the power cord to a working AC outlet. The device will boot automatically.

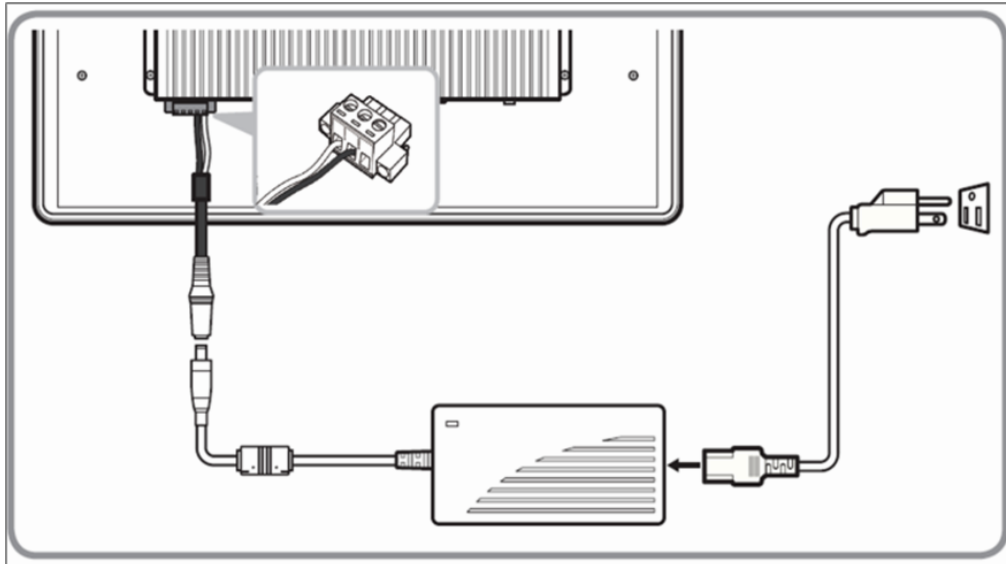

### Connecting to DC Power Source

To connect the M Series Box PC to DC power source:

1. Insert the exposed wires of the DC Power Cable to the appropriate connectors on the terminal block plug.
2. Plug the terminal block plug firmly to the DC IN Jack.
3. Connect the other end of the DC power cable (wires with lug terminals that are labeled “+” and “-” to the terminals of the 9~29V DC Power Source. Ensure that the power connections maintain the proper polarity.

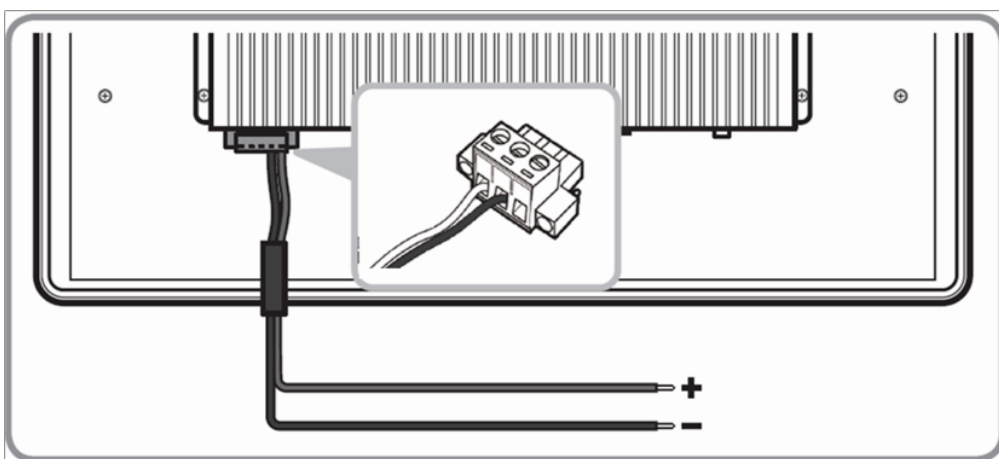

#### NOTE

Power cords vary in appearance by region and country.



## 2.4 Connector Pin Define

### 2.4.1 Isolated DC in Connector

M SERIES BOX PC has a 3pin terminal block that accepts 9~29V DC input.

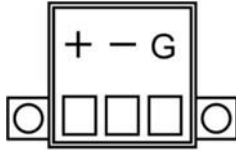

Pin No.	Signal Name	Description
1	VIN+	9-29V DC Input +
2	VIN-	9-29V DC Input -
3	GND	Ground

### 2.4.2 Giga LAN Connector

The M SERIES BOX PC equipped with one RJ45 10/100/1000 Mbps Ethernet interface for connecting to the internet.

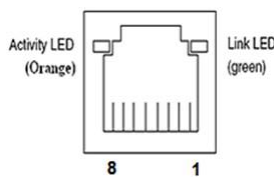

Pin №	Signal Name	Pin №	Signal Name
1	TX1+	2	TX1-
3	TX2+	4	TX2-
5	TX3+	6	TX3-
7	TX4+	8	TX4-

### 2.4.3 USB 3.2 Gen 1 Connector

The M SERIES BOX PC has four USB 3.2 Gen 1 connectors. Use USB3.2 Gen 1 connectors to connect external devices such as mouse or keyboard to the device.

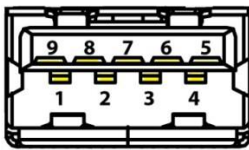

Pin №	Signal Name	Pin №	Signal Name
1	+5V	2	USB_D-
3	USB_D+	4	GND
5	STDA_SSRX-	6	STDA_SSRX+
7	GND_DRAIN	8	STDA_SSTX-
9	STDA_SSTX+		

### 2.4.4 HDMI Output Connector

Use HDMI A Type19-pin female output connector to connect the HMI device to an external display.



Pin №	Signal Name	Pin №	Signal Name
1	TMDS_DATA2+	2	GND
3	TMDS_DATA2-	4	TMDS_DATA1+
5	GND	6	TMDS_DATA1-
7	TMDS_DATA0+	8	GND
9	TMDS_DATA0-	10	TMDS_CLOCK+
11	GND	12	TMDS_CLOCK-
13	CEC	14	NC
15	DDC_CLOCK	16	DDC_DATA
17	GND	18	5V
19	Hot Plug Detect		

## 2.4.5 DP Output Connector

Use HDMI A Type19-pin female output connector to connect the HMI device to an external display.

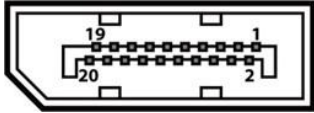

Pin №	Signal Name	Pin №	Signal Name
1	Lane 0+	2	GND
3	Lane 0-	4	Lane 1+
5	GND	6	Lane 1-
7	Lane 2+	8	GND
9	Lane 2-	10	Lane 3+
11	GND	12	Lane 3-
13	AUX_EN_N	14	GND
15	AUX+	16	GND
17	AUX-	18	Hot Plug
19	GND	20	+3.3V

## 2.4.6 Serial Port Connector

The M Series Box PC uses D-SUB 9pin connector to connect serial interfaces.

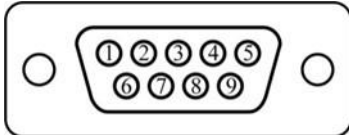

Pin №	RS-232 (Default)	RS-422	RS-485
1	DCD	TxD-	D-
2	RXD	TxD+	D+
3	TXD	RxD+	NC
4	DTR	RxD-	NC
5	GND	GND	GND
6	DSR	NC	NC
7	RTS	NC	NC
8	CTS	NC	NC
9	RI	NC	NC

## 2.4.7 Giga LAN Connector

The M Series Box PC equipped with two RJ45 10/100/1000 Mbps Ethernet interface for connecting to the internet.

Pin No	Signal Name	Pin No	Signal Name
1	TX1+	2	TX1-
3	TX2+	4	TX2-
5	TX3+	6	TX3-
7	TX4+	8	TX4-

## 2.4.8 Audio Combo Connector (Mic in/ Line Out)

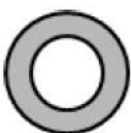



## Chapter 3: Getting Started

### 3.1 How to Enable Watchdog

To enable Watchdog, you need to download Winmate Watchdog utility. Find more information on Watchdog in “Watchdog Guide” that you can download from Winmate Download Center.

To enable watchdog in Watchdog\_AP follow the instructions below:

1. On the right bottom side of the desktop screen, click  **triangle button** to show hidden icons.
2. Click  icon to open Watchdog utility.

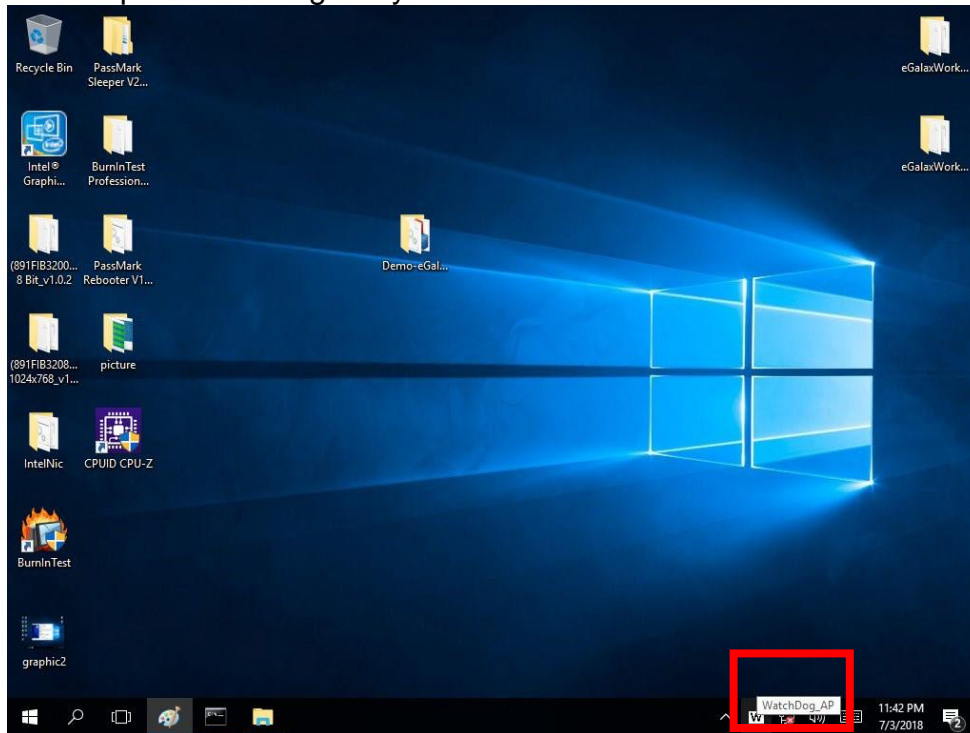

3. In Watchdog utility window set countdown time and periodically feed time, or disable watchdog.

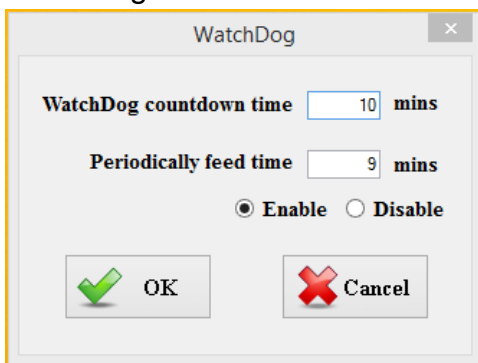

#### Example:

Every 10 min watchdog will monitor the system, in case any error occurs the system will restart automatically when the countdown time reaches 0.

Every 9 min watchdog timer will be reset to 10 min.

Settings	Description
Watchdog Countdown Time	The system automaticity restarts when this countdown time reaches zero. <i>Default: 10 min</i>
Periodically Feed Time	To set a cycle time to automatically reset watchdog timer. <i>Default: 9 min</i>
Enable / Disable	Enable or disable watchdog. <i>Default: Enable</i>

## 3.2 S4 Wake on LAN

In Windows 10 OS shutdown settings will not have Hibernate mode if your storage capacity is below 32 GB.



**Caution** Check if the system has the storage capacity of minimum 32 GB before entering Hibernation mode.

Storage capacity below 32 GB:

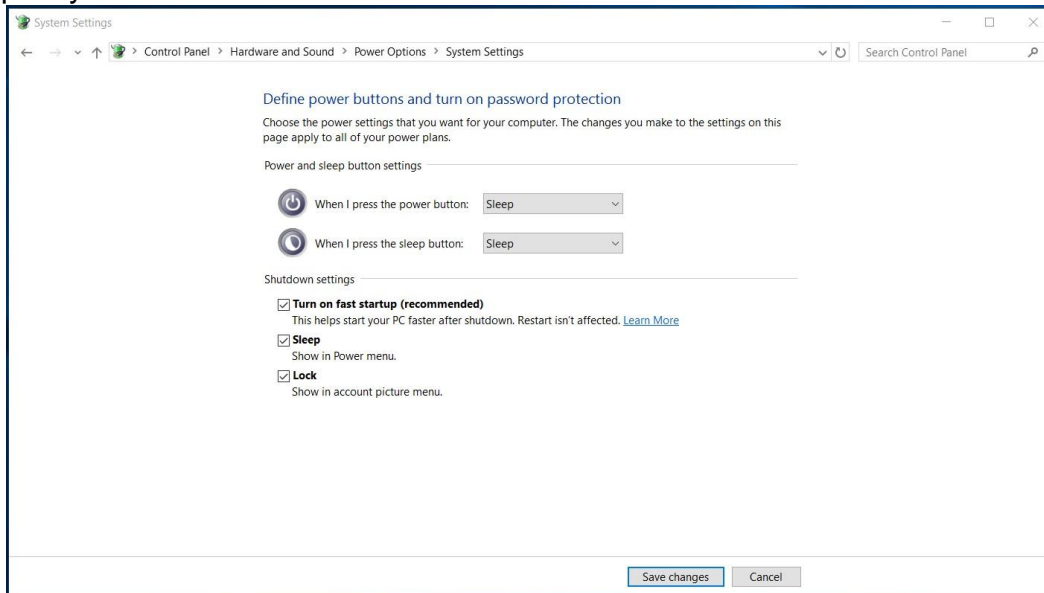

Storage capacity above 32 GB

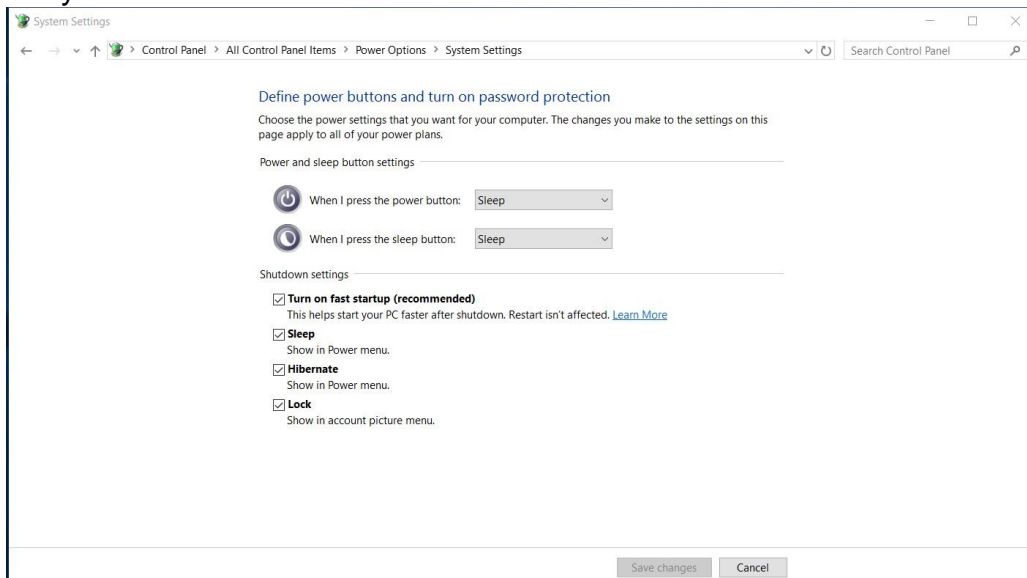

## 3.3 Using Recovery Wizard to Restore Computer

**Note:**

Before starting the recovery process, make sure to backup all user data. The data will be lost after the recovery process.

To enable quick one-key recovery procedure:

**Important:**

Before starting the recovery process, remove the PCIe card.

1. Connect the computer to the power source. Make sure the computer stays plugged in to power source during the recovery process.
2. Turn on the computer, and when the boot screen shows up, press **F6** to initiate the Recovery Wizard.
3. The following screen shows the Recovery Wizard. Click **Recovery** button to continue

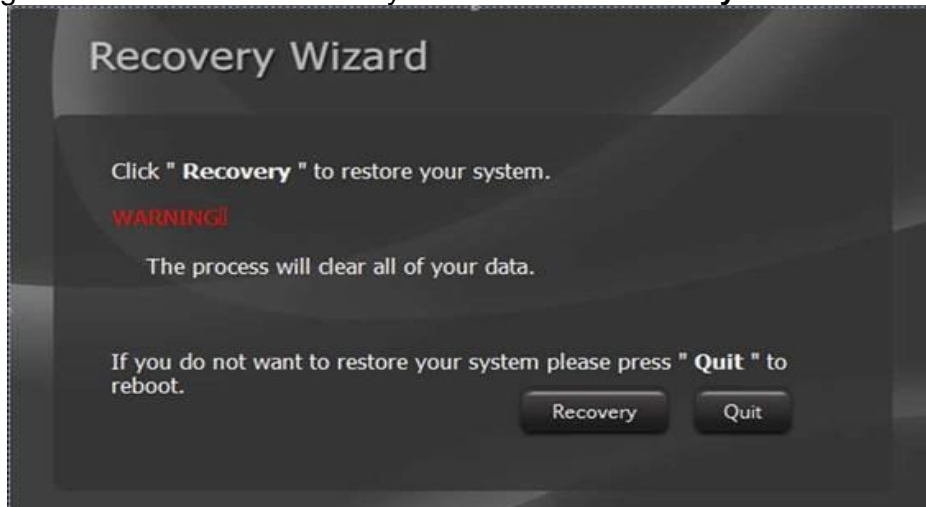

4. A warning message about data loss will show up. Make sure the data is backed up before recovery, and click Yes to continue.



5. Wait the recovery process to complete. During the recovery process, a command prompt will show up to indicate the percent of recovery process complete. Please restart your computer manually.

## 3.4 Driver Installation

This chapter contains driver installation guide. Follow the instructions below to complete the installation. You will quickly complete the installation. This chapter provides instructions on how to install drivers on the M SERIES BOX PC.

### 3.4.1 Chipset Driver

1. Follow instructions below to install Chipset driver.

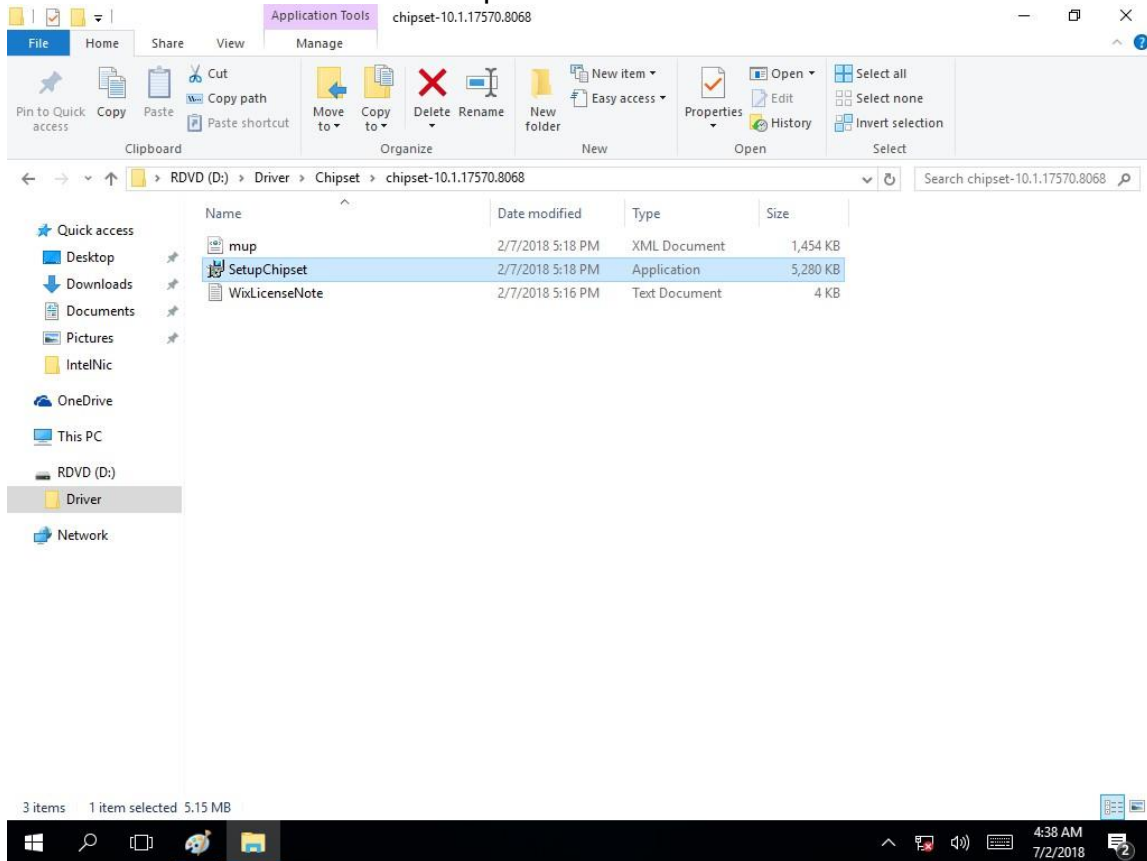

2. Installation window will pop up, select **Next**.

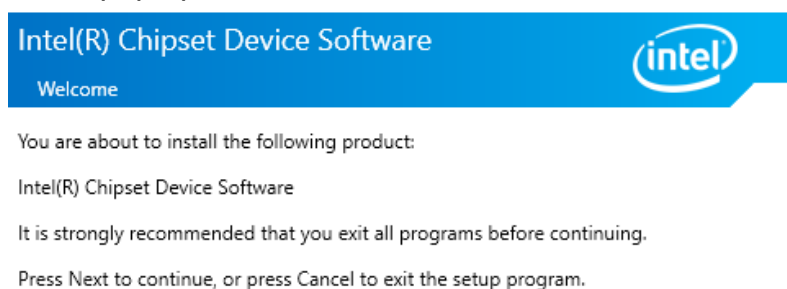

Next

Cancel

3. Select **Accept** to agree with the terms of license agreement.

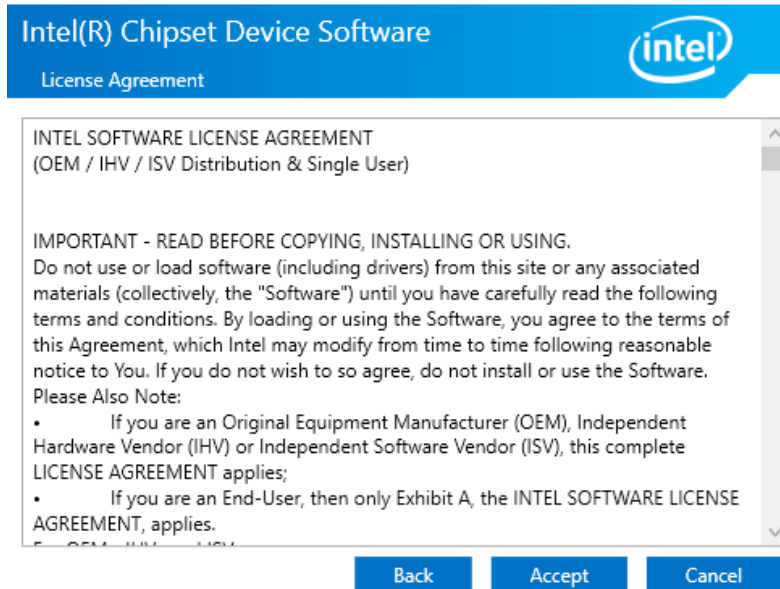

4. Check the ReadMe file information, select **Install** to continue.

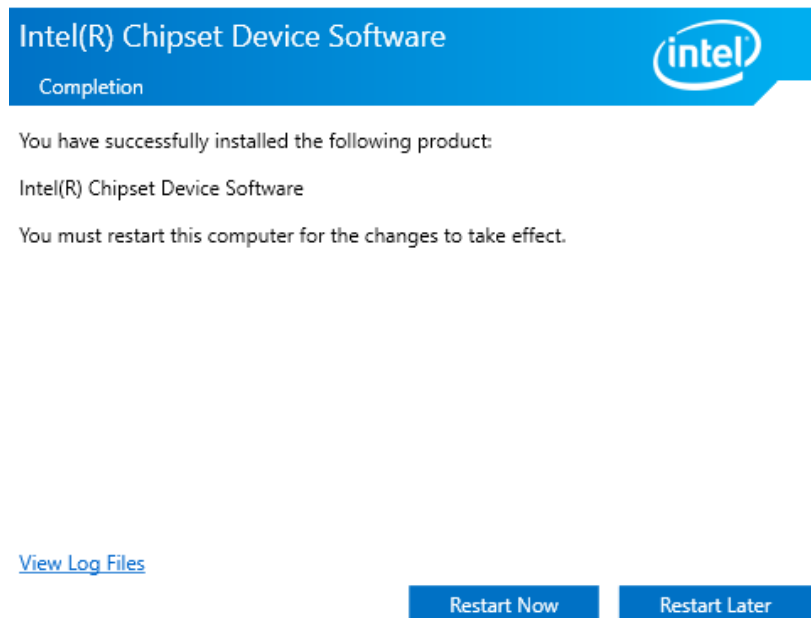

5. Wait for the driver to be installed. When installation completed, select **Restart Now** to restart your computer.



## 3.4.2 Graphic Driver

Follow instructions below to install Graphic driver.

1. Open the Driver CD (included in the package) and select **Graphic driver**.

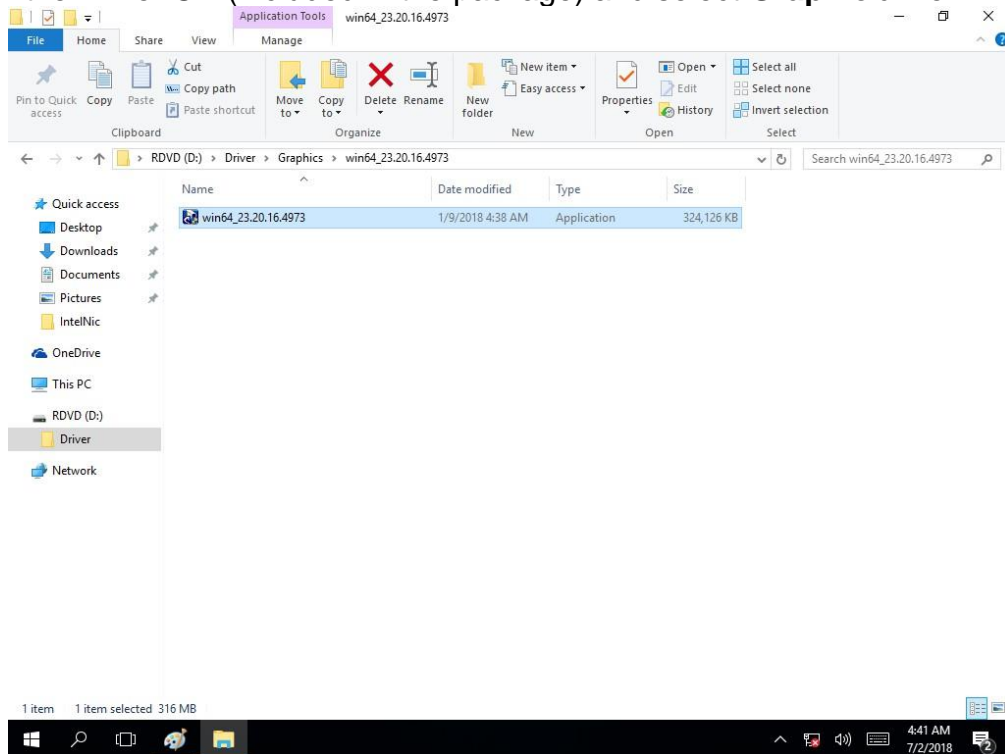

2. Installation window will pop up, select **Next**.

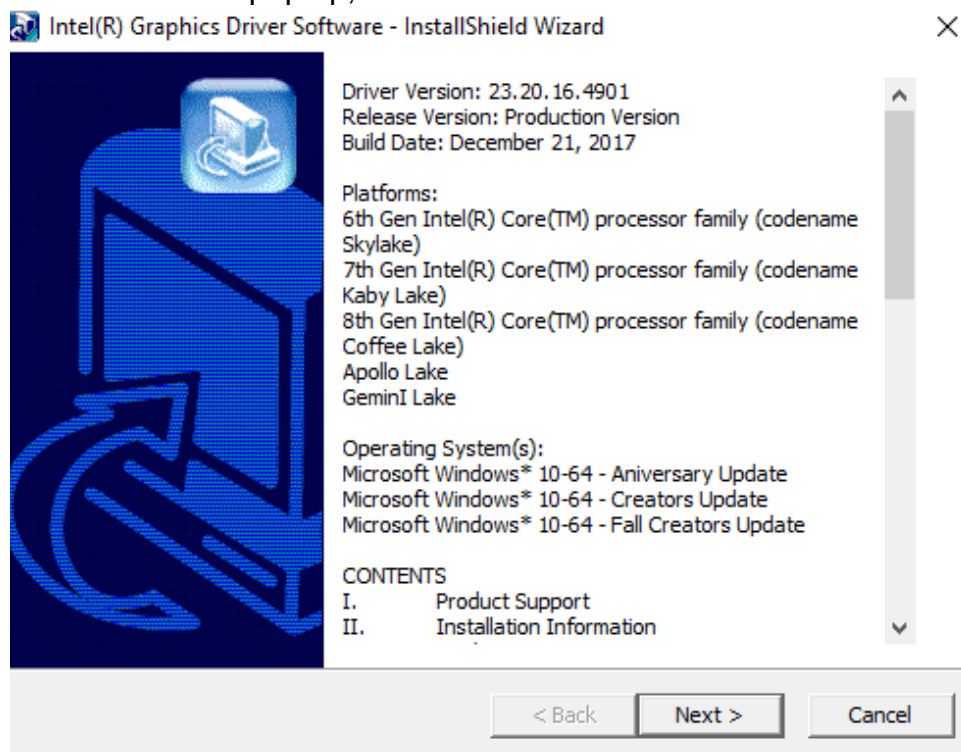



3. Select Accept to agree with the terms of license agreement.

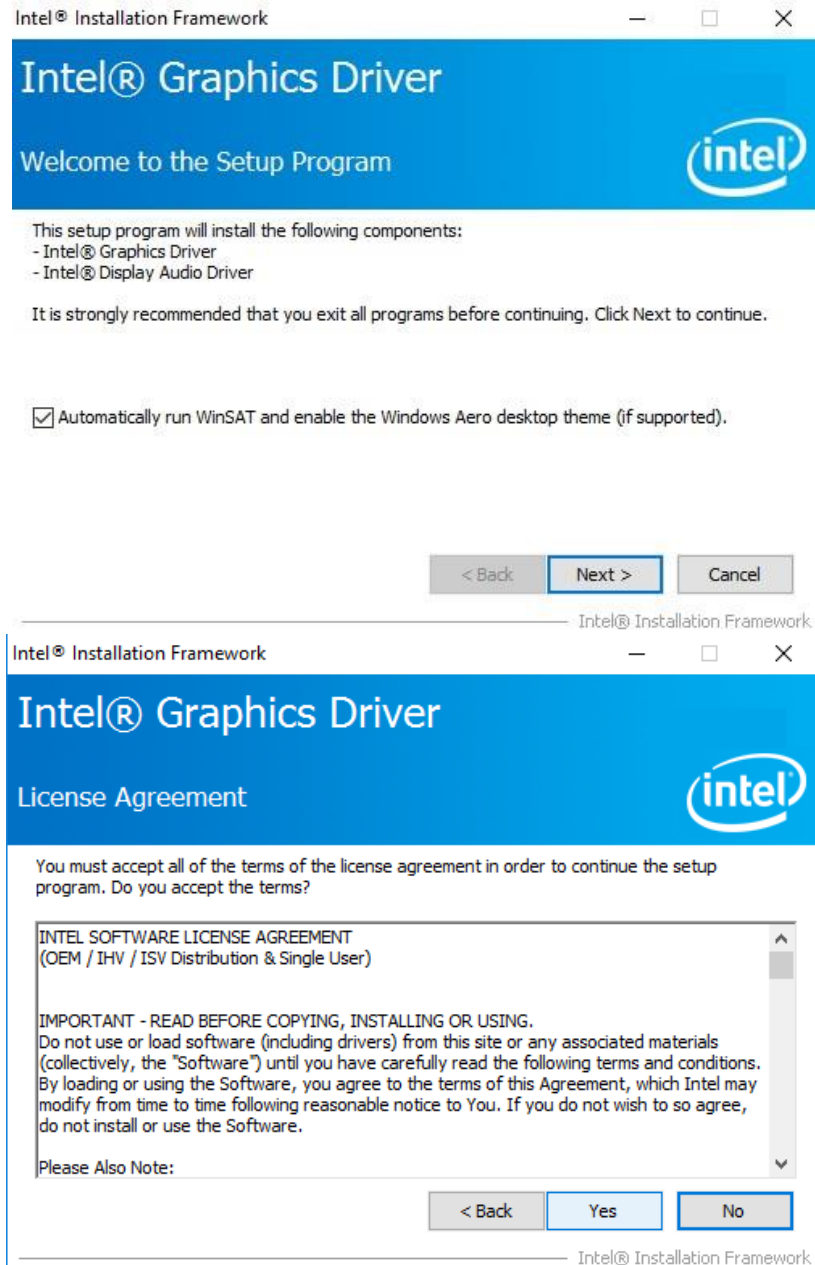

4. Check the ReadMe file information, select **Next** to continue.

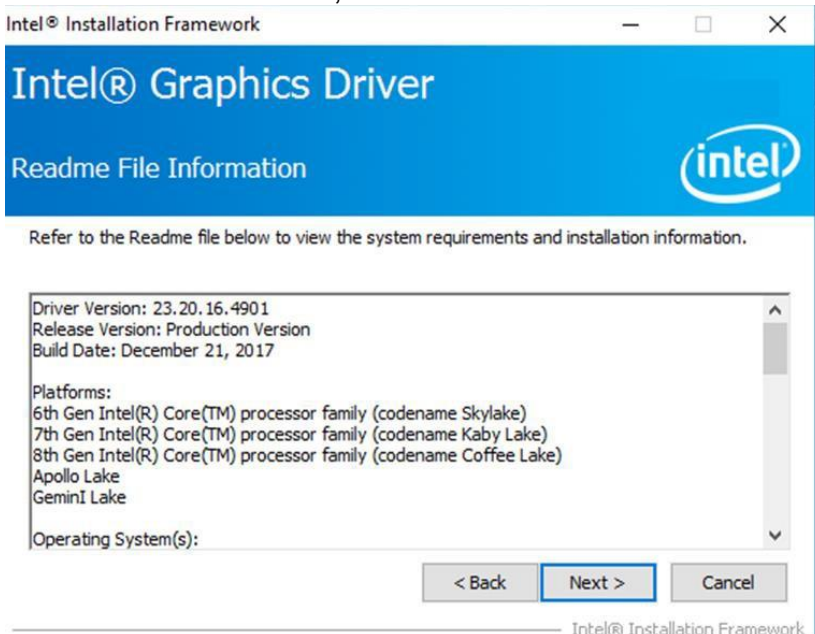

5. Wait for the driver to be installed.

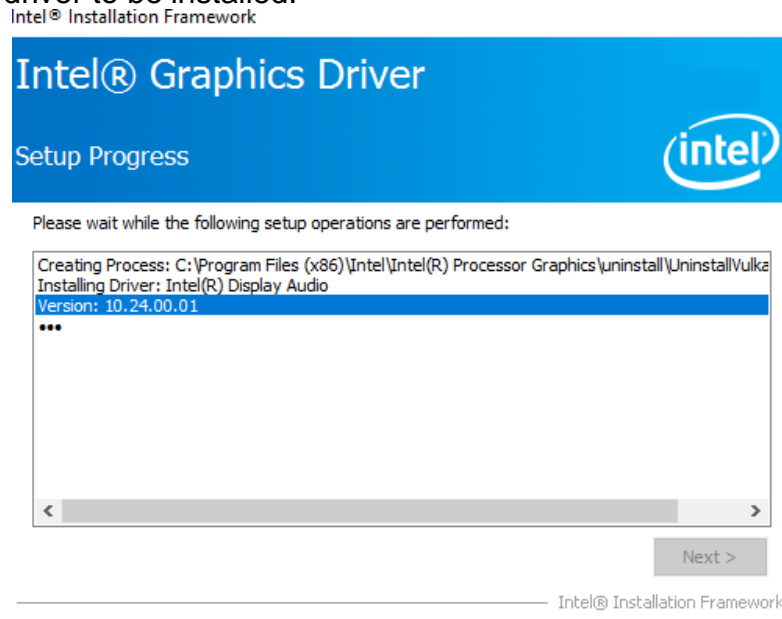

6. Select **Next** to continue.

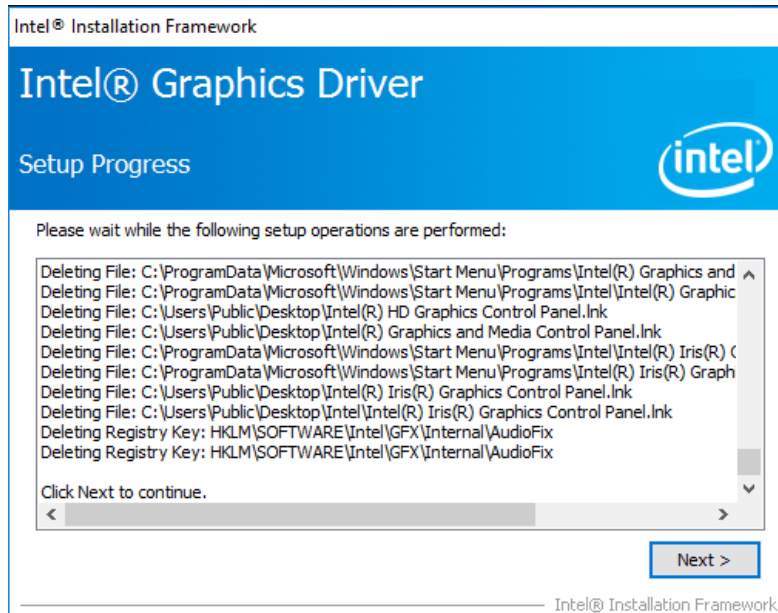

7. After installation is completed, select “**Yes, I want to restart this computer now**”, and click **Finish**.

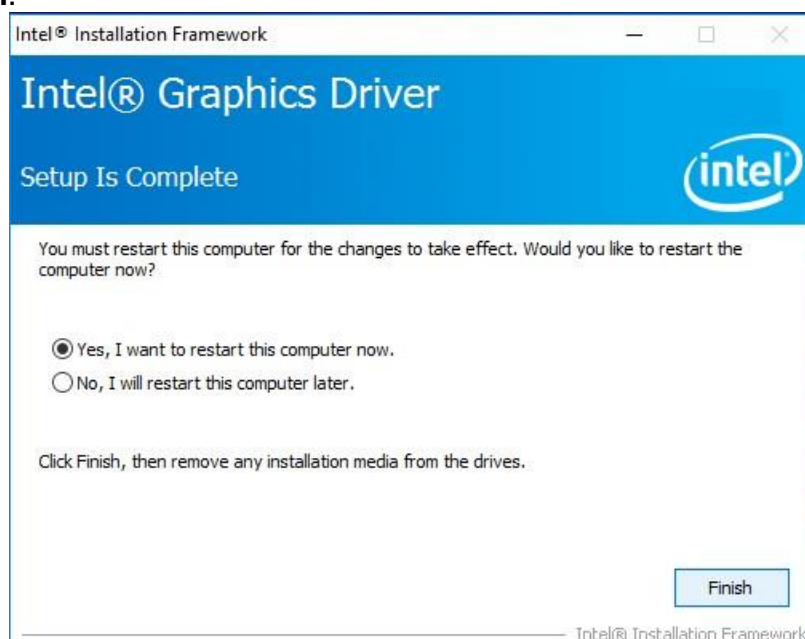

### 3.4.3 Management Engine (ME)

Follow instructions below to install Management Engine (ME).

1. Open the Driver CD (included in the package) and select **ME** driver.

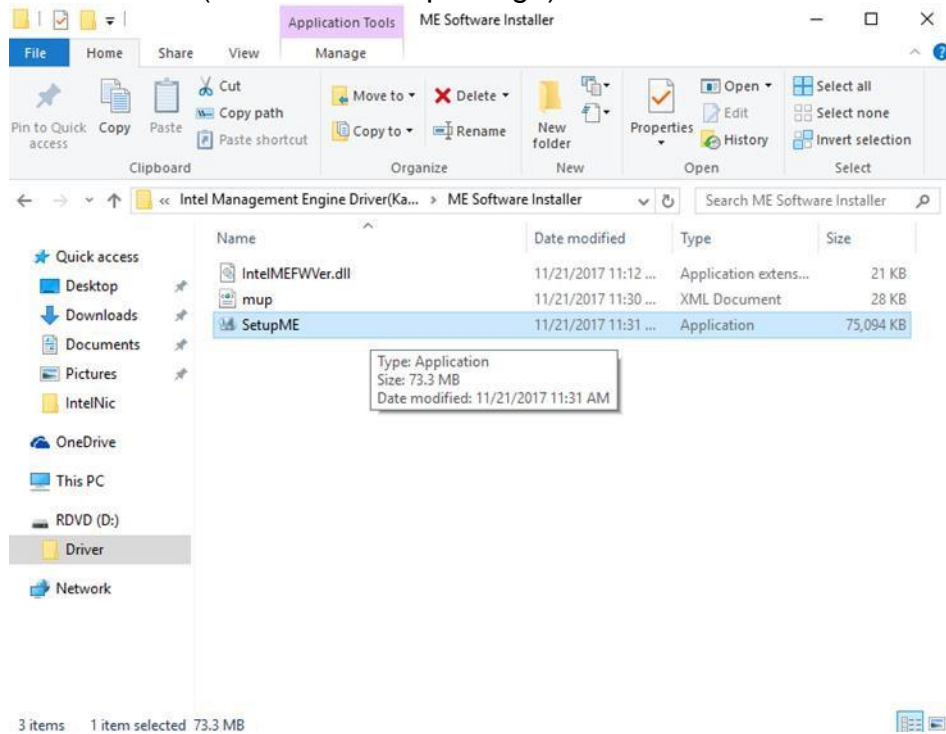

2. Select **Next** to start the installation.

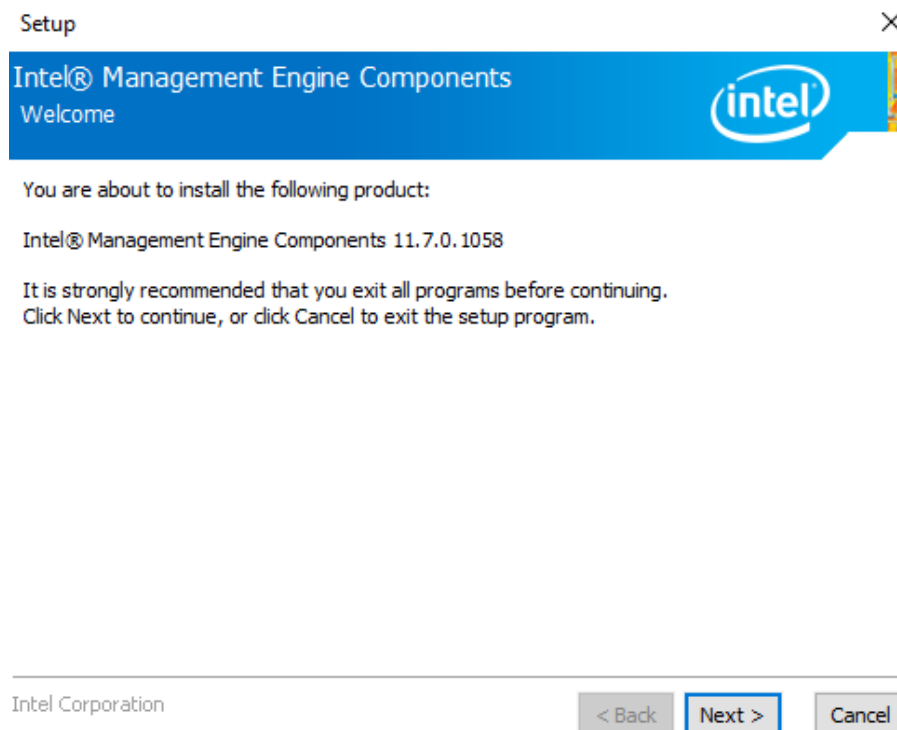

3. Select **Next** to agree with the terms of license agreement.

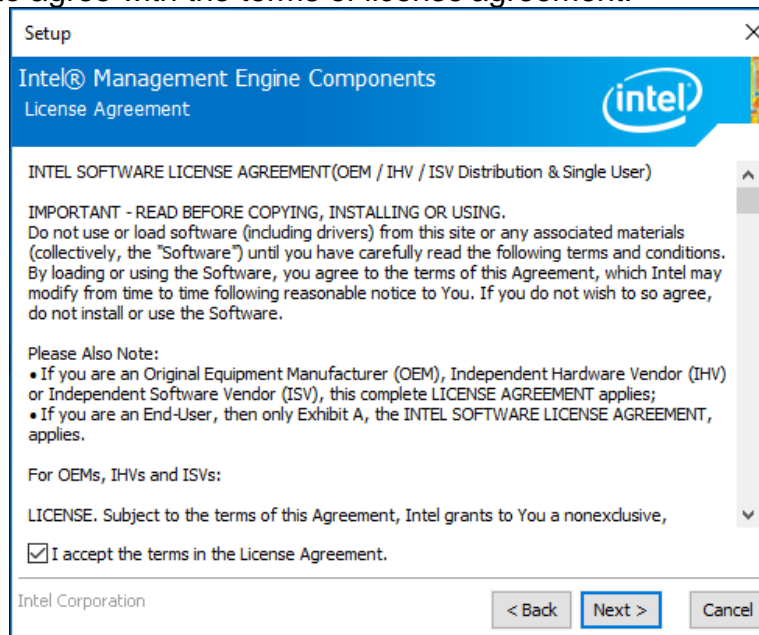

4. Wait for the driver to be installed.

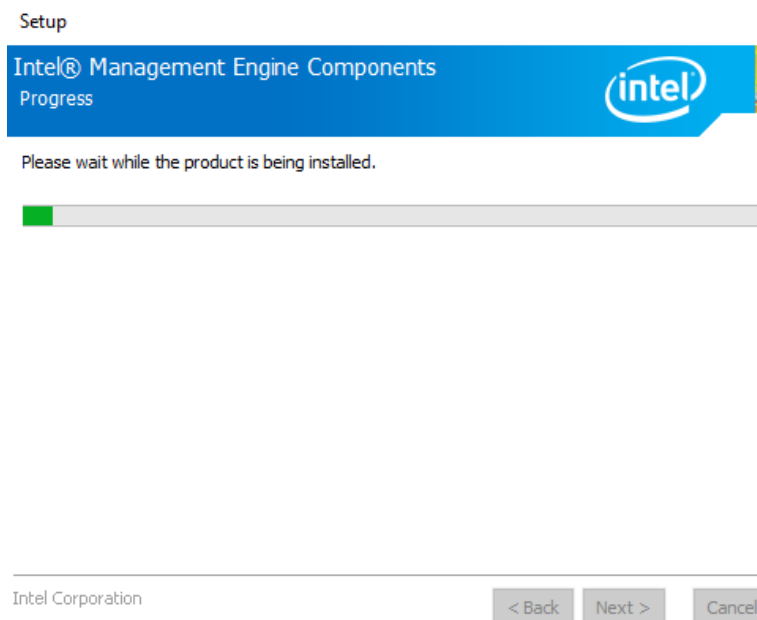

5. When installation completed, select **Finish** complete installation.

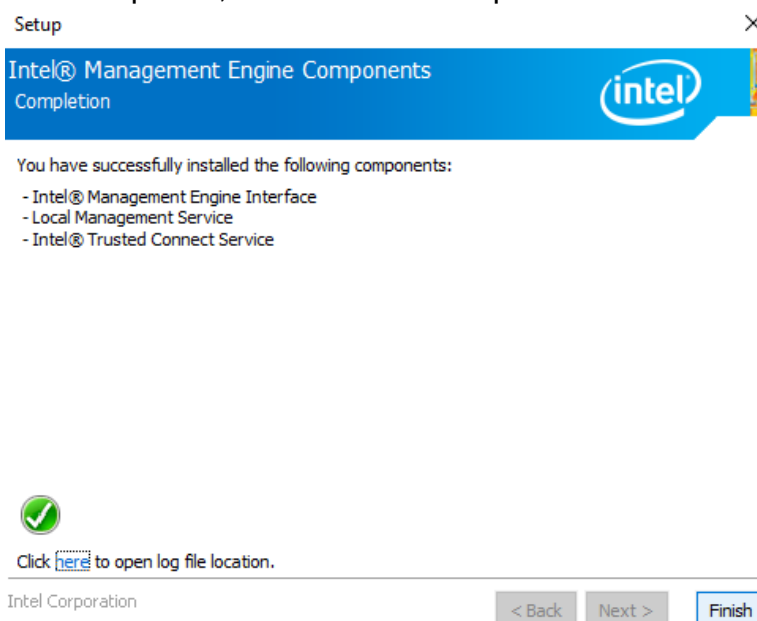

### 3.4.4 Intel GNA Driver

For Intel 11th Gen Intel CPU which are required to install the Intel Gaussian and Neural Accelerator (GNA) driver, please refer to the instructions below to complete the process.

1. Open the Driver CD (included in the package) and select **Intel GNA** driver
2. In the folder, find “gna.inf” and right click on “gna.inf” and select “Install”.

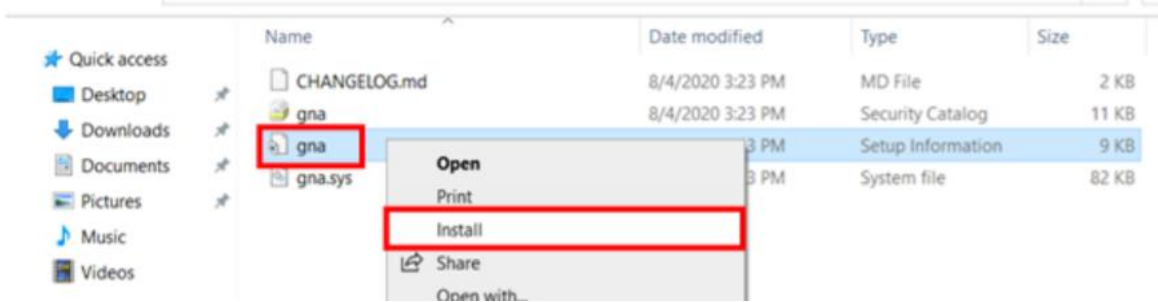

3. Once the installation completes, the following message will show up

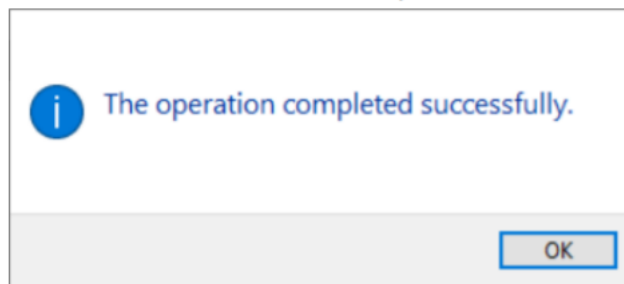

### 3.4.5 Intel Serial IO Driver

This utility installs the originally shipped version of the Intel Serial IO GPIO Host Controller driver.

1. Open the Driver CD (included in the package) and select **Serial IO** driver
2. Locate the **SetupSerialIO.exe** file.
3. Right click on the executable and select 'Run as administrator' option from the menu to start the installer and then click 'Yes' button in User Account Control pop-up window.

名稱	修改日期	類型	大小
production	2021/6/23 上午 11:14	檔案資料夾	
SerialIO_30.100.2031.2_PV_TGL-LP_20H1v2	2021/6/23 下午 02:53	檔案資料夾	
Intel(R) Serial IO - Bring Up Guide and releas...	2020/9/12 上午 02:57	Adobe Acrobat 文件	385 KB
mup.xml	2020/8/20 下午 01:46	XML Document	6 KB
ReadMe.TXT	2020/6/11 上午 03:03	文字文件	46 KB
SetupSerialIO.exe	2020/9/11 下午 01:17	應用程式	2,039 KB
Software License Agreement (PV).pdf	2017/11/11 上午 12:38	Adobe Acrobat 文件	167 KB
WixLicenseNote.txt	2016/8/30 上午 09:28	文字文件	13 KB

4. Click 'Next >' button to continue the installation.

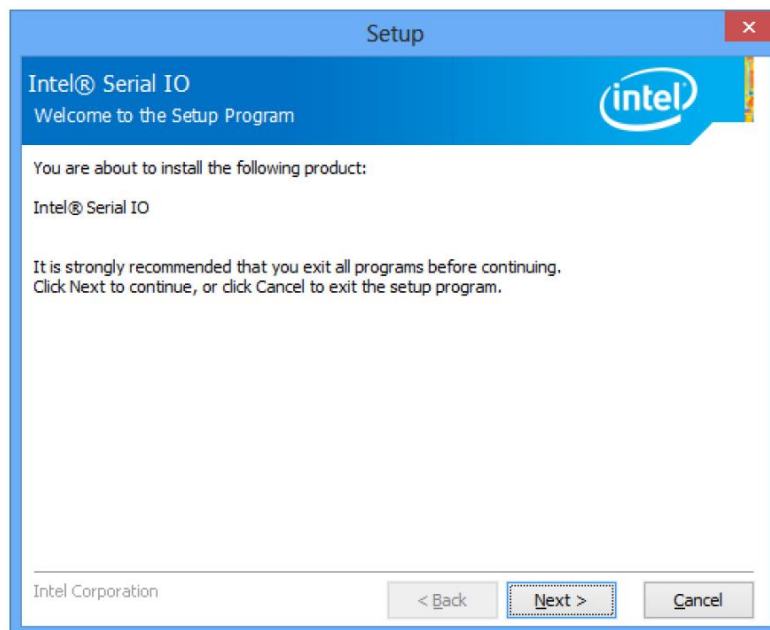

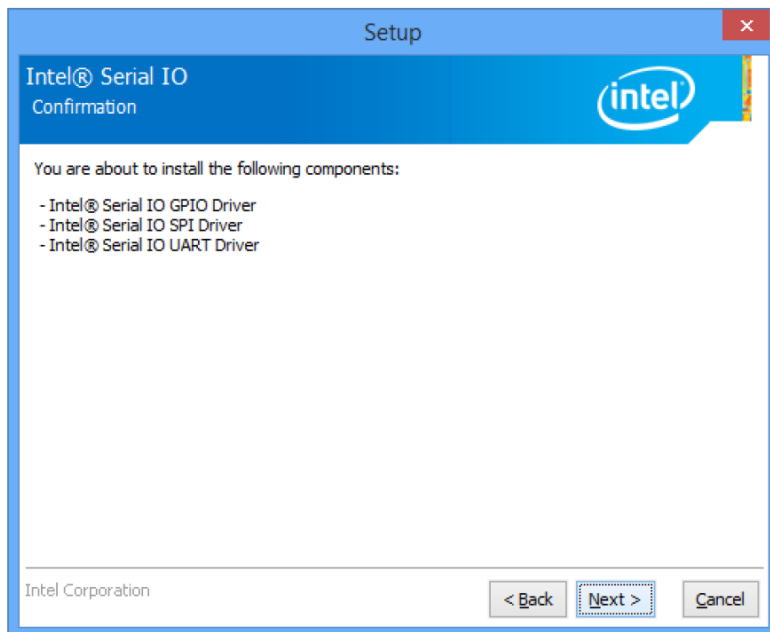
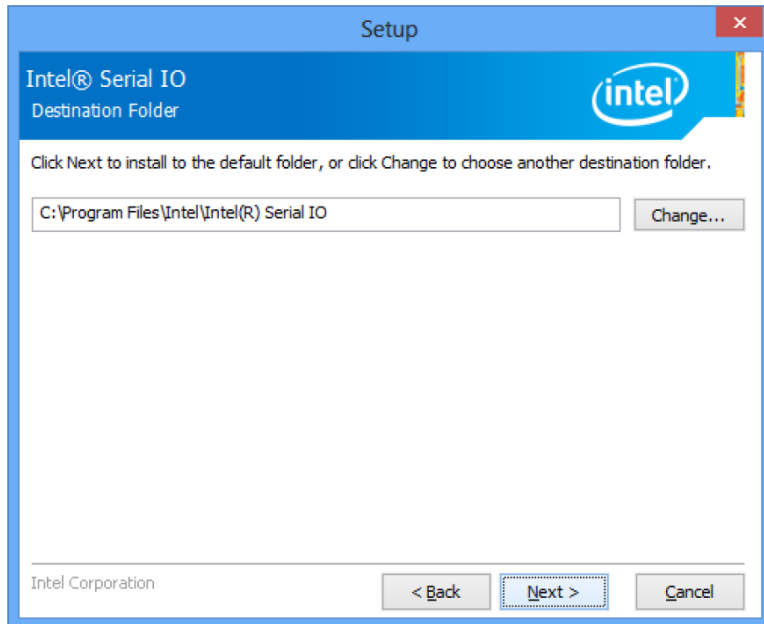

5. After successful installation, you should see setup completion screen. Click on 'Finish' button to complete the installation.

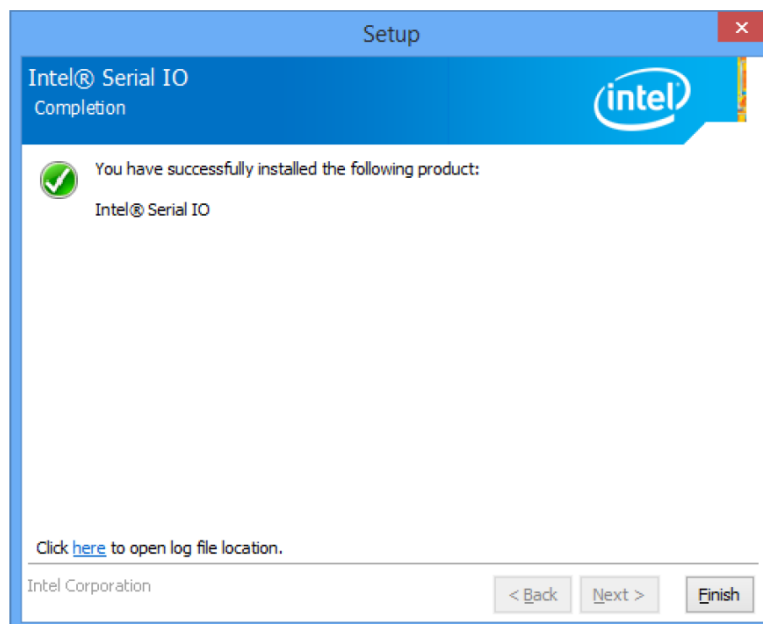

## 3.4.6 Audio Driver

Follow instructions below to install Audio driver.

1. Open the Driver CD (included in the package) and select **Audio** driver.

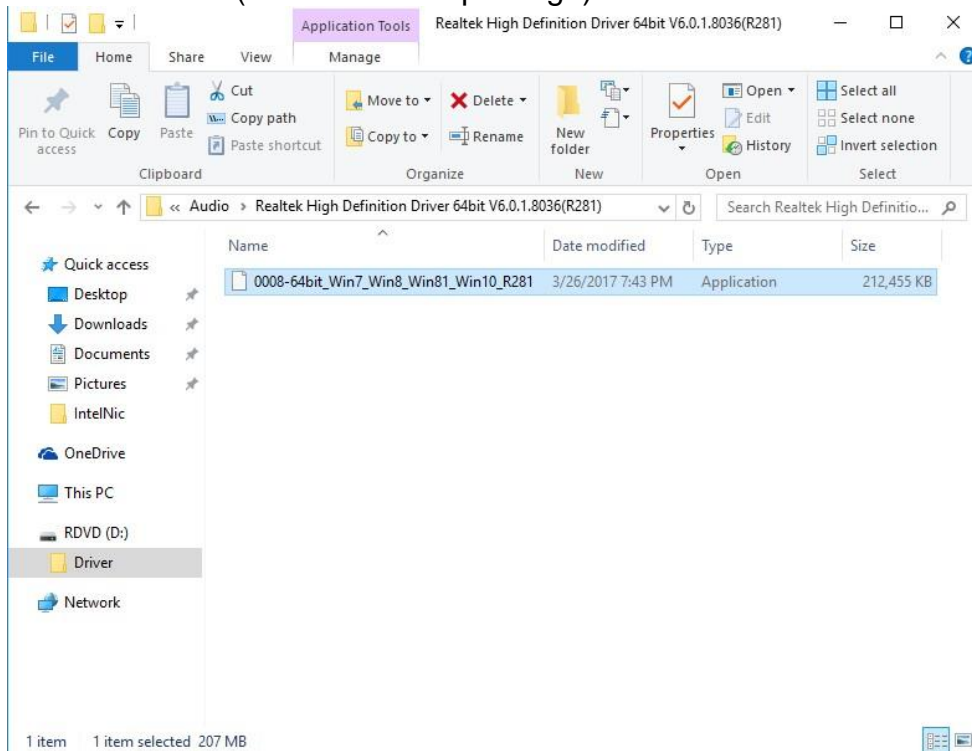

2. Select **Next** to continue.

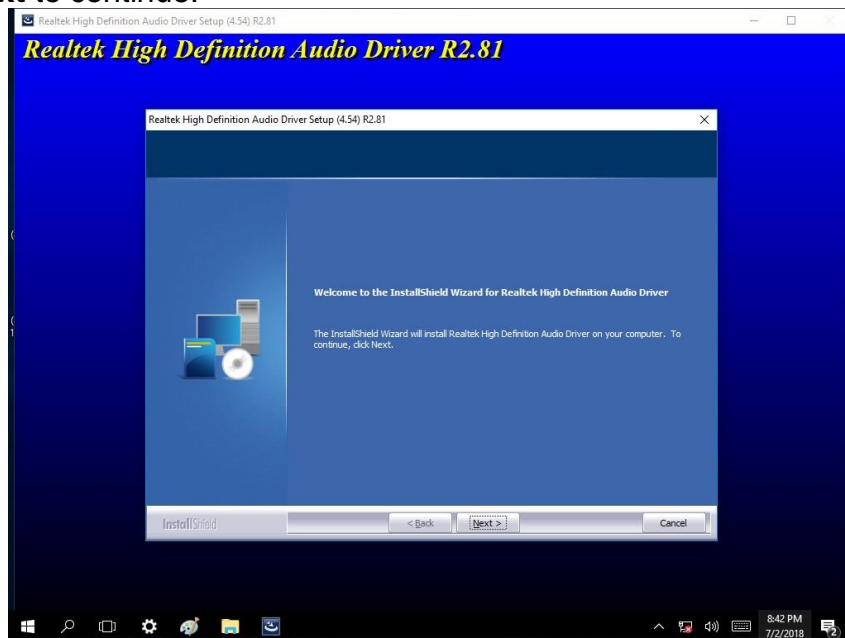



3. When installation completed, select **Finish** complete installation.



## 3.4.7 Ethernet Driver

Follow instructions below to install LAN driver.

1. Open the Driver CD (included in the package) and select **LAN** driver.

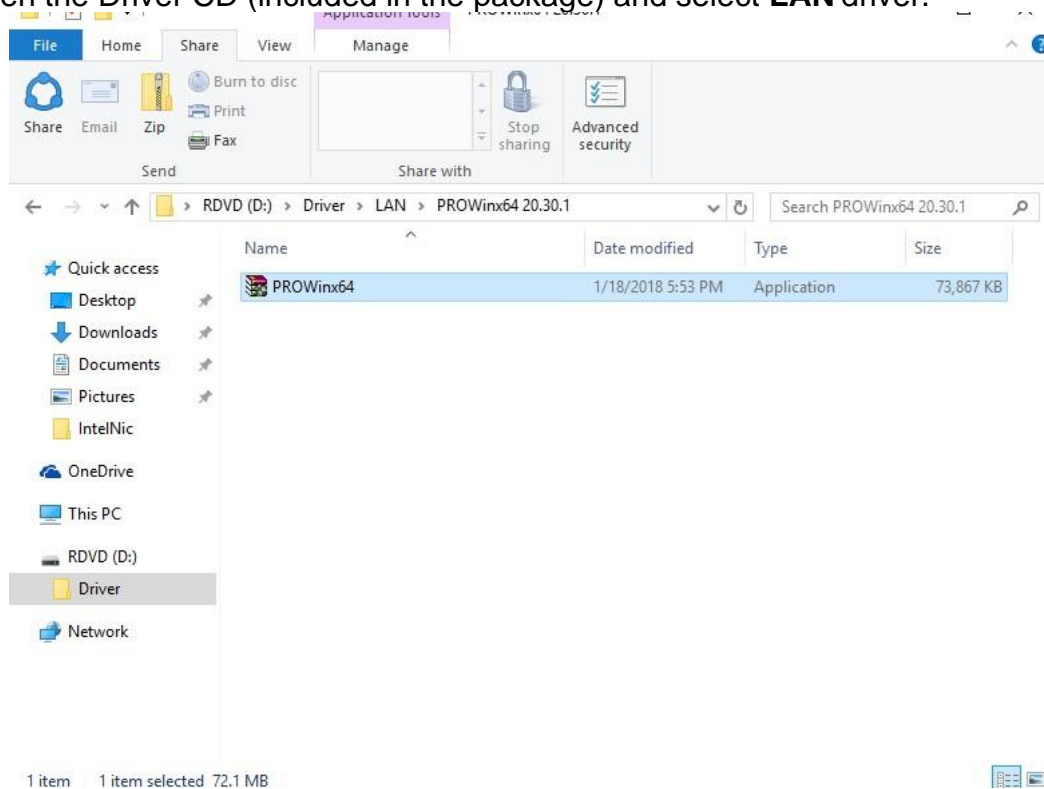

2. When compression is complete, select **Next**.

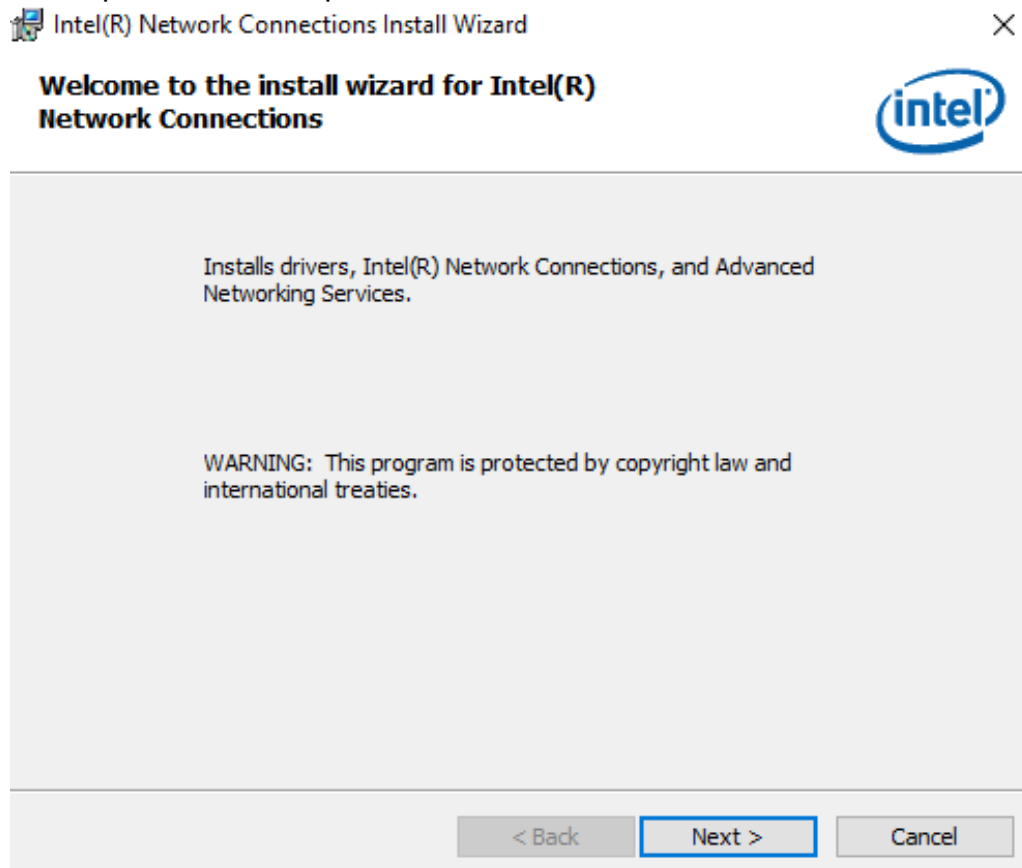

3. Read the license agreement, and then select **Next**.

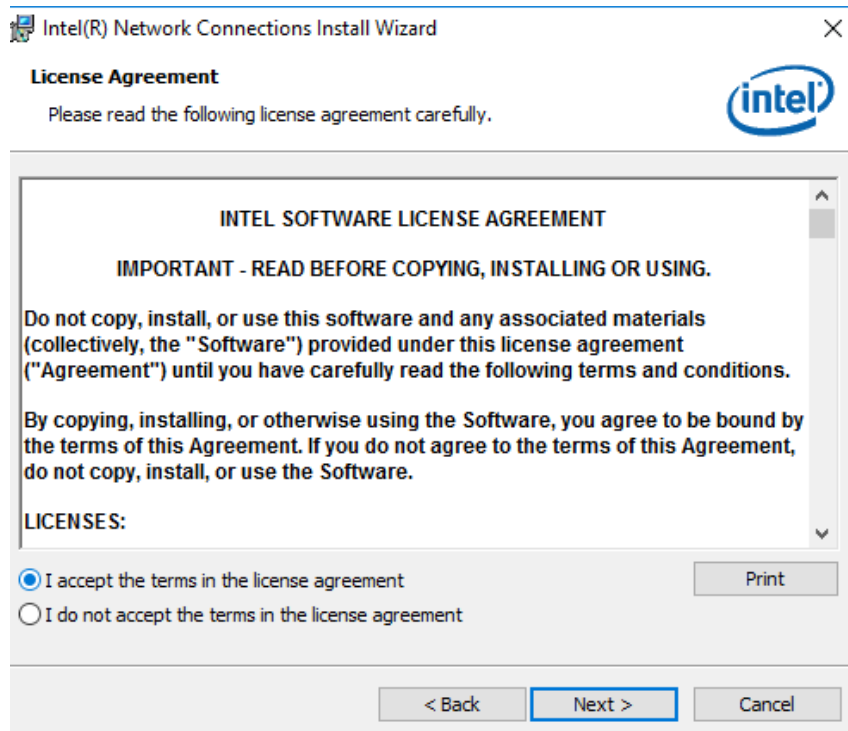

4. System displays the installed packages, select **Next**.

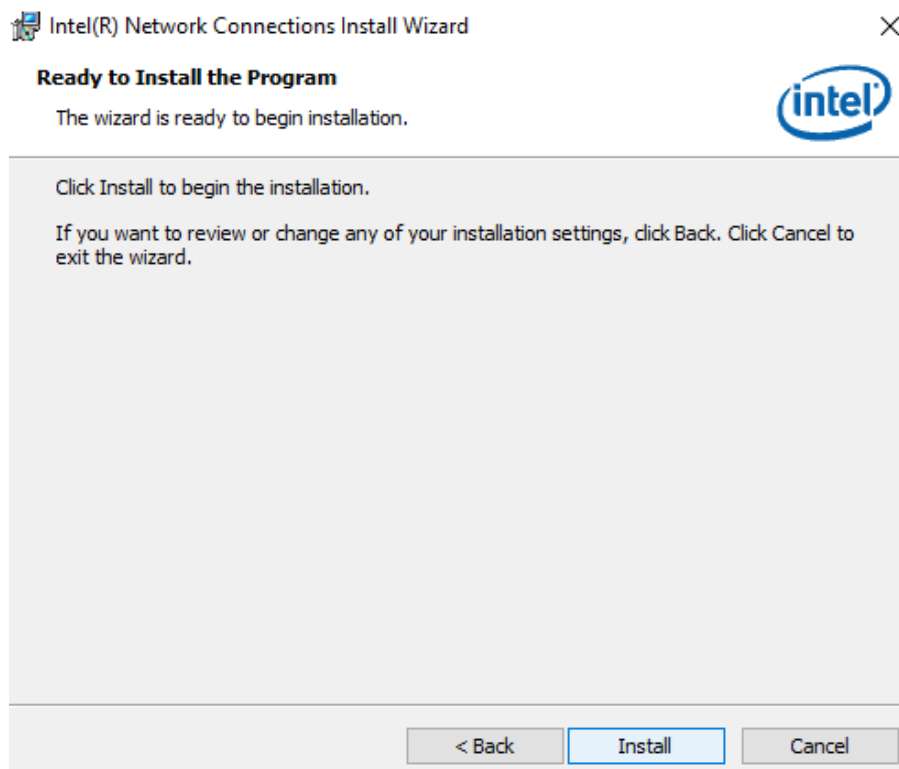

5. Confirm the installation, select **Install** to start the installation.

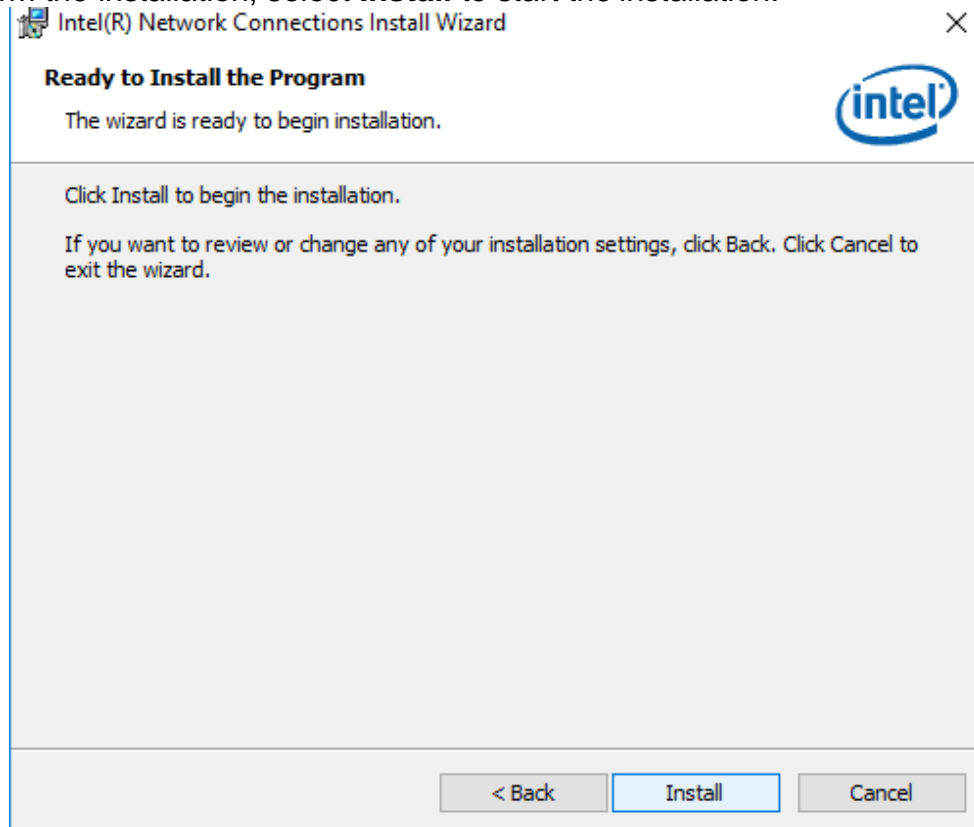

6. When installation is completed, select **Finish** to close the window.

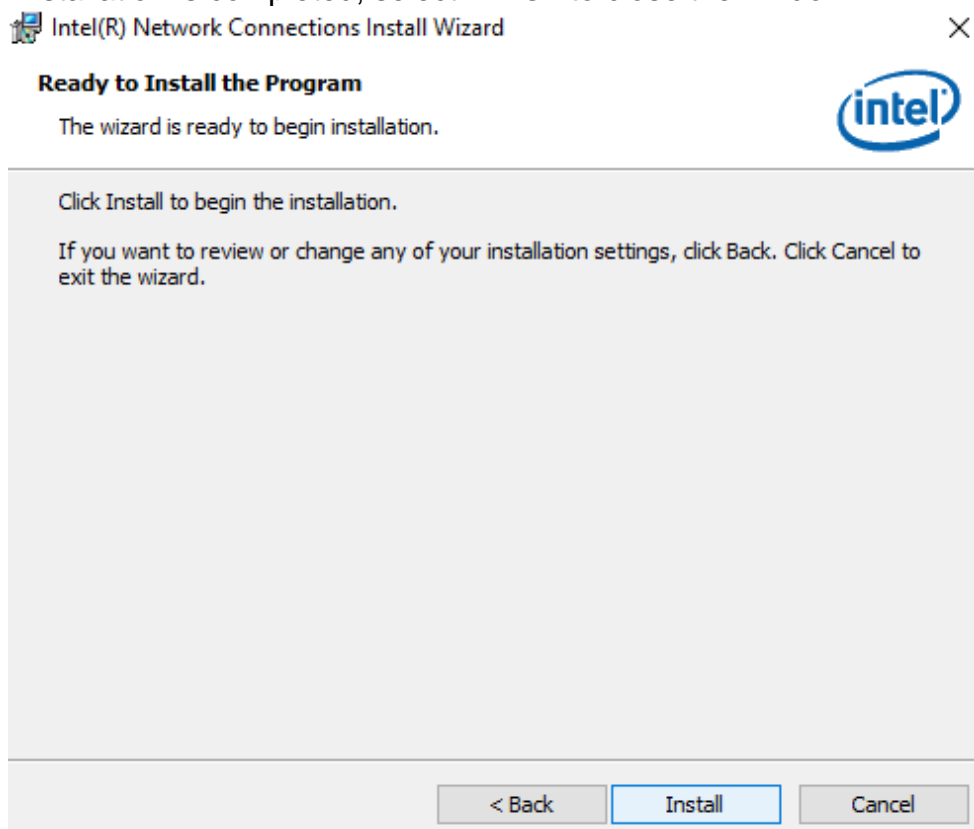

### 3.4.8 Watchdog Driver Installation

Follow instructions below to install **Watchdog** driver.

1. Type “cmd” in the run box then the cmd.exe will appear in programs.

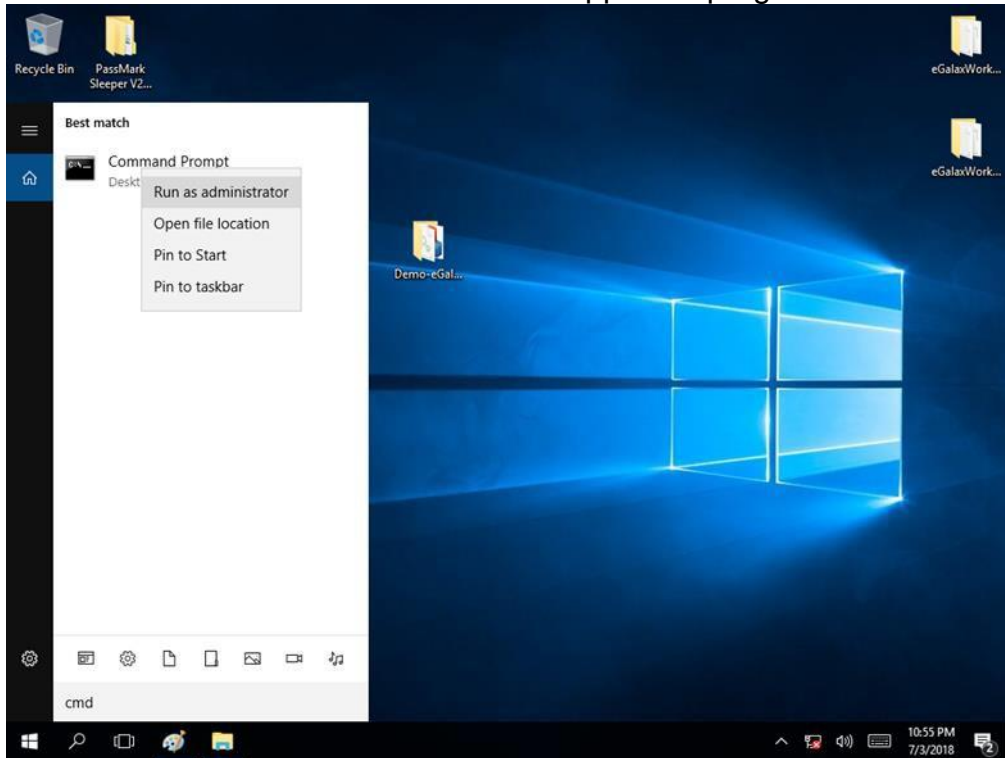

2. Right click on the cmd.exe and click on “Run as administrator” to start
3. Open the Driver CD (included in the package) and select Watchdog driver.

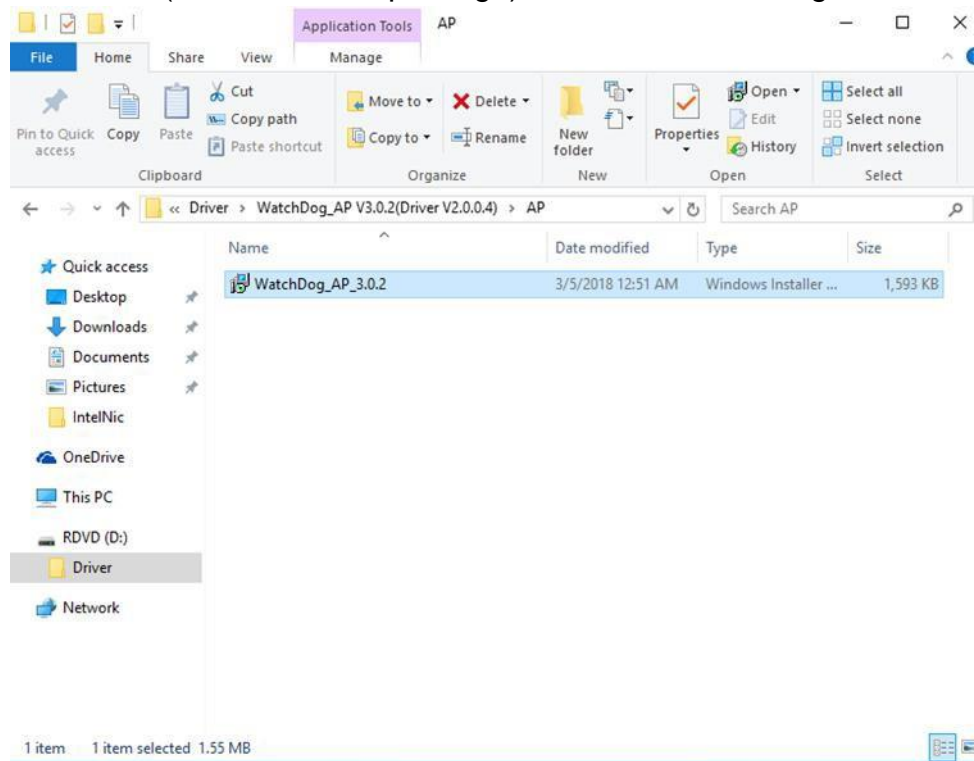

4. When Windows Security dialog appear, select **install** to continue the Installation.

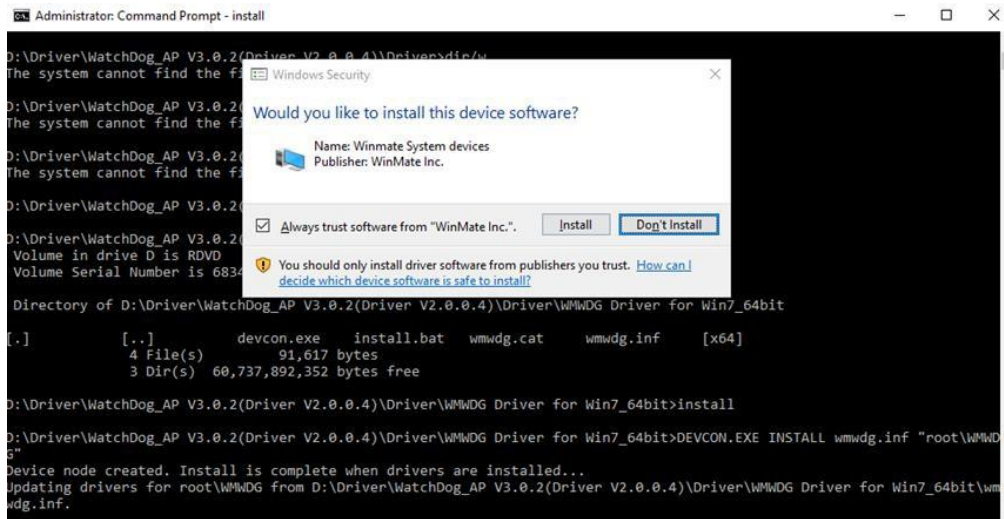

5. Wait for installation to complete. When installation is complete, press any key to close.

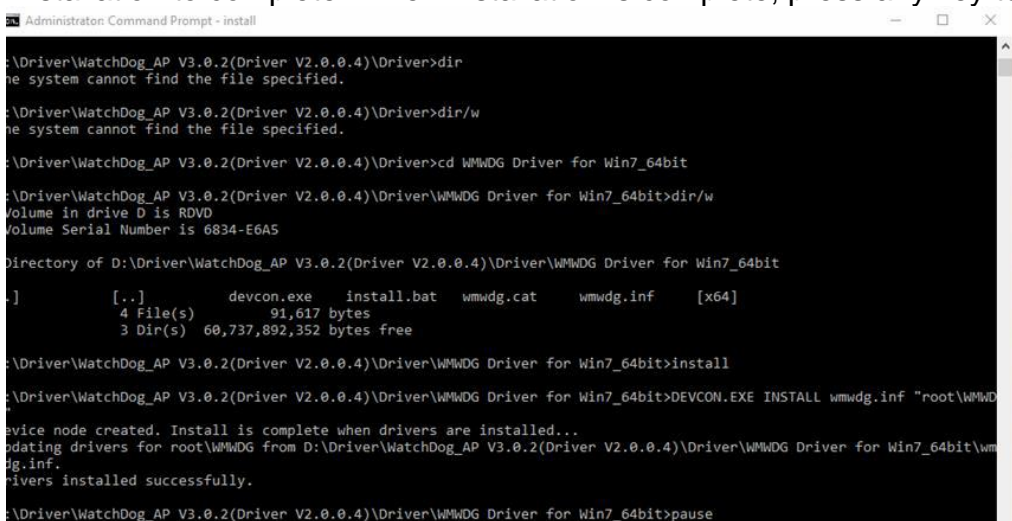

6. Open the Driver CD (included in the package) and select **Watchdog AP**.

7. Select **Next**.



8. The installed storage location is displayed, select **Next** to continue.

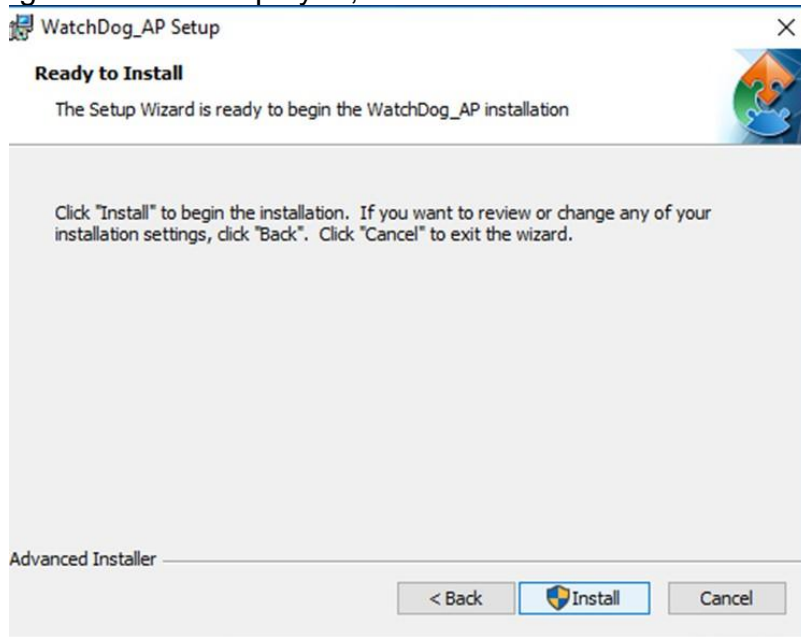

9. Select **Next** to start the installation.

10. When installation is completed, select **Finish** to close the window.



## Chapter 4: BIOS Setting

This chapter provides information on how to use BIOS setup, its functions and menu.

### 4.1 How and When to Use BIOS Setup

To enter the BIOS setup, you need to connect an external USB keyboard, external monitor and press Del key when the prompt appears on the screen during start up. The prompt screen shows only few seconds so need press Del key quickly.



#### IMPORTANT:

Updated BIOS version may be published after the manual released. Check the latest version of BIOS on the website.

You may need to run BIOS setup utility for reasons listed below:

1. Error message on screen indicates to check BIOS setup
2. Restoring the factory default settings.
3. Modifying the specific hardware specifications
4. Necessity to optimize specifications

#### BIOS Navigation Keys

The following keys are enabled during POST:

Key	Function
Del	Enters the BIOS setup menu.
F7	Display the boot menu. Lists all bootable devices that are connected to the system. With cursor ↑ and cursor ↓ and by pressing <ENTER>, select the device used for the boot.
Pause	Pressing the [Pause] key stops the POST. Press any other key to resume the POST.

The following Keys can be used after entering the BIOS Setup.

Key	Function
F1	Help
F5/ F6	Change Values
F9	Setup Defaults
F10	Save & Exit
Esc	Exit
Enter	Select SubMenu
↑/ ↓	Select Item
← / →	Select Item

For items marked ► press <Enter> for more options.



#### NOTE:

You can press the F1, F2, F3, F4, -/+ , and Esc keys by connecting a USB keyboard to your computer.



## 4.2 BIOS Functions

### 4.2.1 Main Menu

The Main menu displays the basic information about your system including BIOS version, processor RC version, system language, time, and date.

When you enter BIOS setup, the first menu that appears on the screen is the main menu. It contains the system information including BIOS version, processor RC version, system language, time, and date.

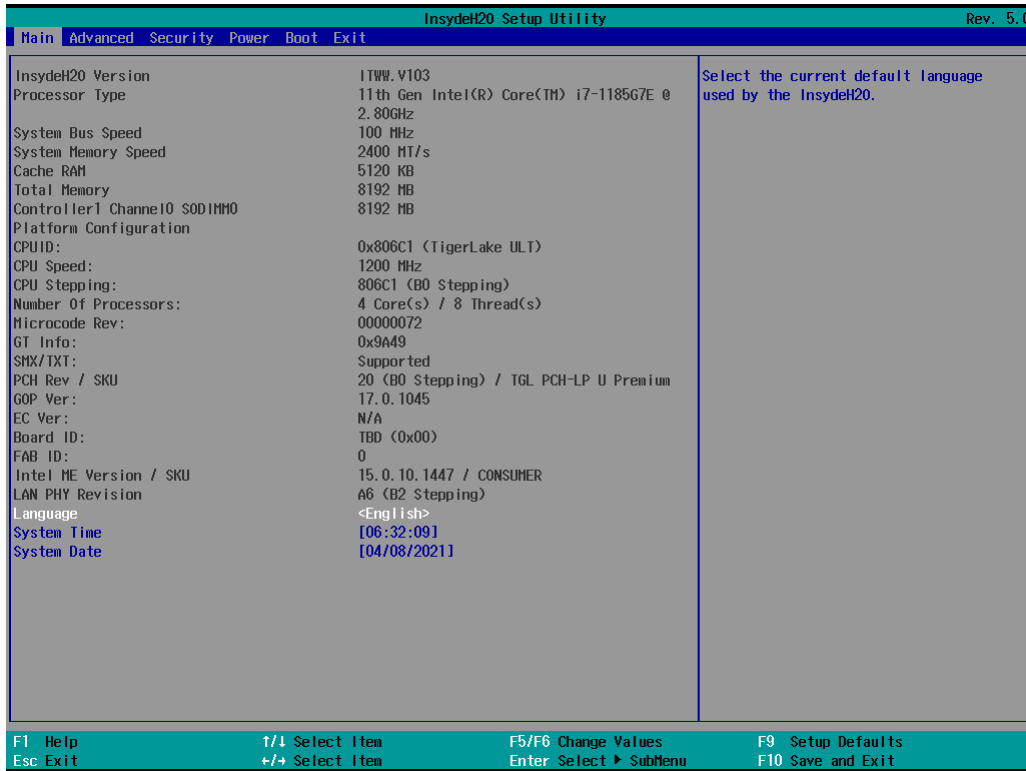

## 4.2.2 Boot

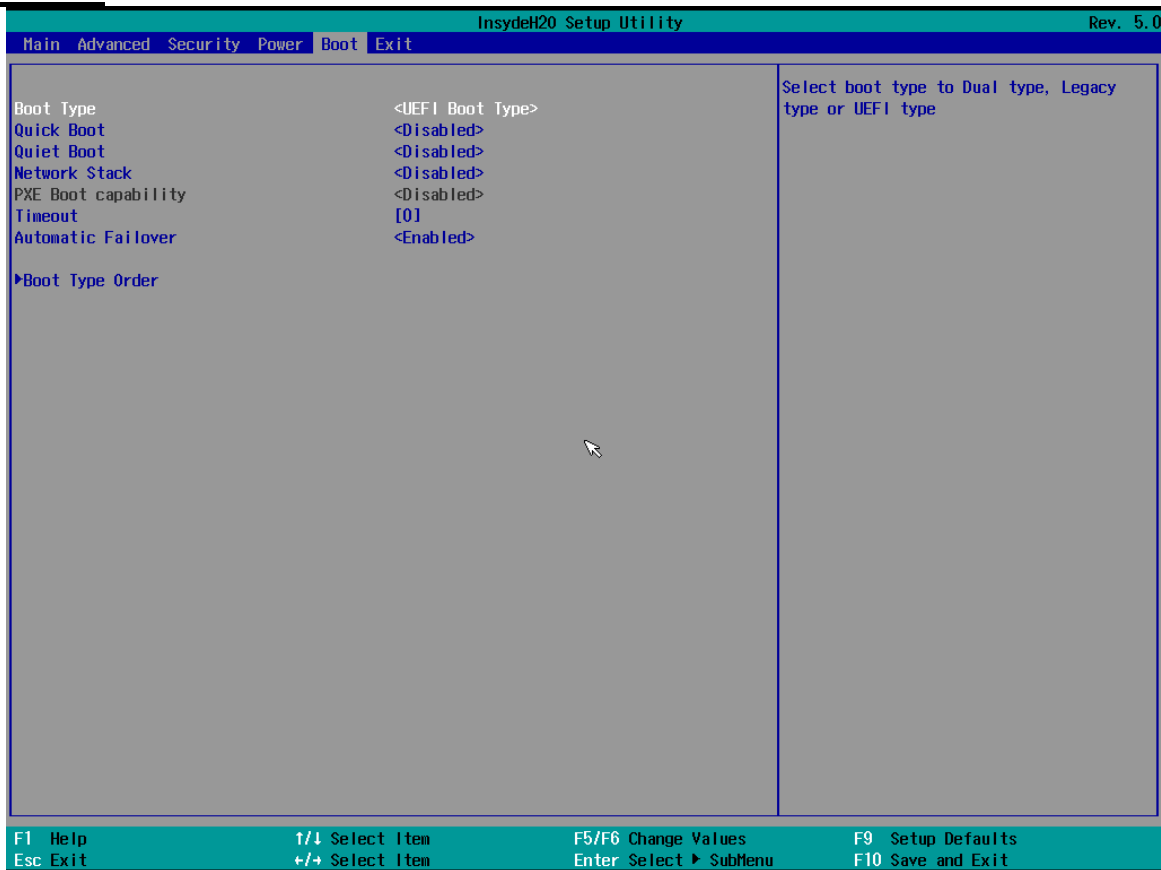

BIOS Setting	Description	Setting Option	Effect
Boot Type	Boot Type configuration	UEFI Boot Type	Select boot type to Dual type, Legacy type or UEFI type
Quick Boot	Quick Boot configuration	Enabled Disabled	Allows InsydeH20 to skip certain tests while booting. This will decrease the time needed to boot the system
Quiet Boot	Quiet Boot configuration	Enabled Disabled	Disable or enable booting in text Mode.
Network Stack	Network Stack configuration	Disabled Enabled	Network Stack Support: Windows 8 Bitlocker Unlock UEFI IPv4/ IPv6 PXE Legacy PXE OPROM
Timeout	Timeout	[Value]	Timeout settings
Automatic Failover		Enable	If boot to default device fail, it will directly try to boot next device
		Disable	If boot to default device fail, it will pop warning message then go to firmware UI
Boot Type Order	Boot Type Order	Enter	Opens sub-menu

### 4.2.3 Serial Port Mode Settings: RS232, RS485, RS422

InsydeH20 Setup Utility		Rev. 5.0
Advanced		
F81968 Chip 1		UART Configuration
I/O Configuration Port	4Eh/4Fh	
▶UART Port 1 Configuration		
▶UART Port 2 Configuration		
▶UART Port 3 Configuration		
▶UART Port 4 Configuration		
▶UART Port 5 Configuration		
▶UART Port 6 Configuration		
▶Hardware Monitor		
Watch-Dog Timer	<Always Off>	
▶GPIO Group 0 Configuration		
▶GPIO Group 7 Configuration		

F1 Help      ↑/↓ Select Item      F5/F6 Change Values      F9 Setup Defaults  
 Esc Exit      +/+ Select Item      Enter Select ▶ SubMenu      F10 Save and Exit

InsydeH20 Setup Utility		Rev. 5.0
Advanced		
UART Port 1 Configuration		Configure UART Port using options :
UART Port 1	<Enabled>	[Disabled] Disable device
Base I/O Address	<3F8h>	[Enabled] Enable device and use
Interrupt	<IRQ4>	below settings
Peripheral Type	<RS232>	
Clock Source	<1.8432 MHz>	

F1 Help      ↑/↓ Select Item      F5/F6 Change Values      F9 Setup Defaults  
 Esc Exit      +/+ Select Item      Enter Select ▶ SubMenu      F10 Save and Exit

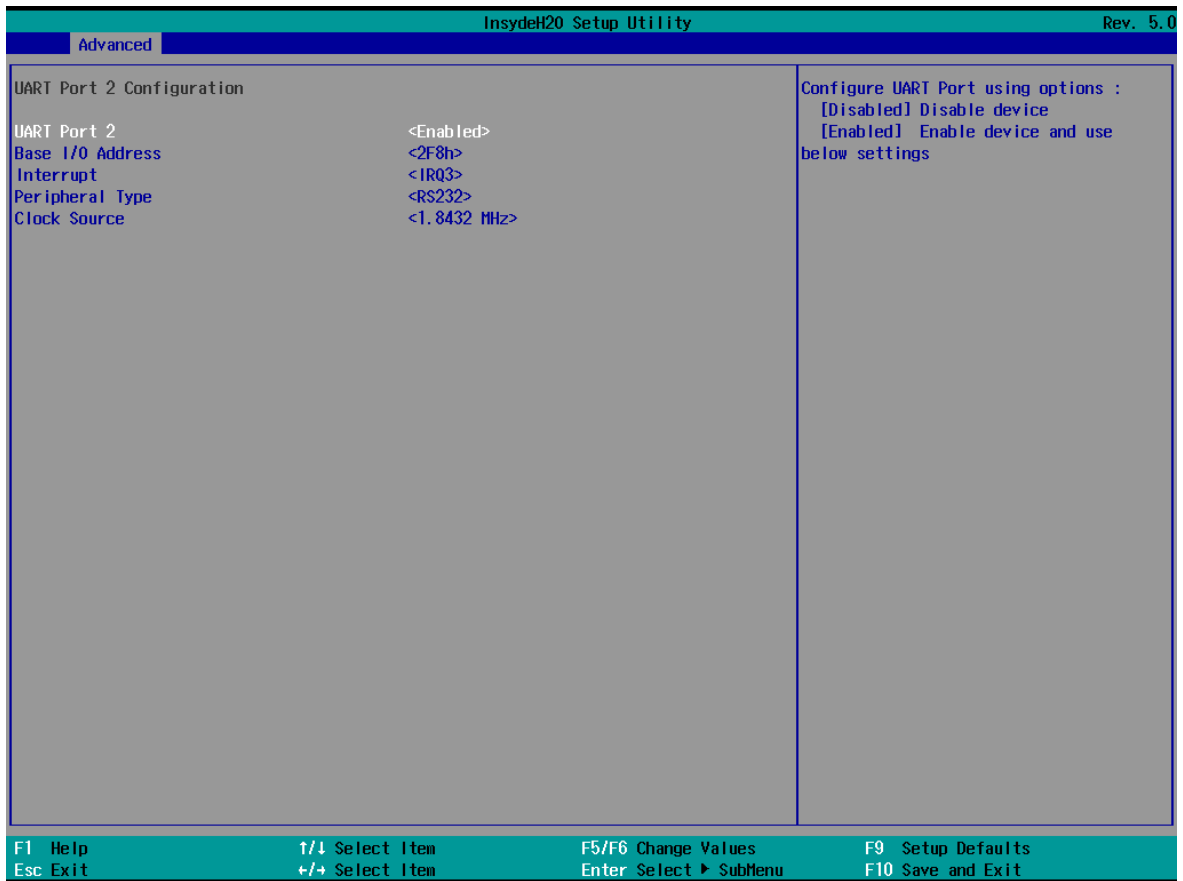

## Chapter 5: Specifications

		Model name		
		ITMH100	ITMH100-6L	ITMH200
System Specification	Processor	Intel® Tiger Lake Core™ i5-1135G7, 2.4 GHz(turbo up to 4.2GHz)		
	Memory	2 x SODIMM, DDR4 3200 MHz, 4GB 8GB (Optional) 16GB (Optional) 32GB (Optional)		
	Storage	1 x M.2 2280 NVMe SSD, 128GB up to 512GB 2 x 2.5" Removable 256GB SSD up to 512GB (Optional)		
	Ethernet controller	Intel® Ethernet Controller I211-AT + Intel® Ethernet Connection I219-LM		
	Operating System	Windows 10 IoT Enterprise (Optional)		
	WLAN	Support (Optional)		
	BT	Support (Optional)		
Mechanical Specification	Expansion Port	Modular Design for easy service in the field site	-	
	Dimension	276 x 207 x 60 mm	316.4 x 206.8 x 62 mm	
	Mounting	Desk Mounting	VESA Mounting, Desk Mounting	
	Enclosure	Metal Housing		
	Cooling System	Fanless design		
Environment	Operating Humidity	10% to 90% (non-condensing)		
	Operating Temperature	0~50°C		
	Storage Temperature	-10~60°C		
Certification	Certification	CE, FCC		
IO Ports	Power Input	1 x 9~29V DC, 3-Pin Terminal Block		
	USB Port	4 x USB 3.2 Gen.1 (Type-A)		
	Serial Port	2 x RS232/422/485 (Default RS232)		
	Video	1 x DP1.4 1 x HDMI 2.0 (Optional)		
	Audio	1 x Audio Combo Connector (Mic in / Line Out)		
	Expansion Port	1 x mPCIe slot 1 x PCIe x16 slot (x4 signal) (module max size:180x121mm) 1 x M.2 2230 Key E slot for WiFi 1 x M.2 2280 Key M slot for NVMe SSD Swappable 2.5" HDD/SSD Bay Slot	1 x M.2 2230 Key E slot for WiFi 1 x M.2 2280 Key M slot for NVMe SSD Swappable 2.5" HDD/SSD Bay Slot	
	LAN	2 x Giga LAN RJ45 Connector	6 x Giga LAN RJ45 Connector	2 x Giga LAN RJ45 Connector
Indicator	1 x LED Indicator for storage			
Control	Button	1 x Power Button with LED Indicator 1 x Reset Button		

Accessory	Accessory	100~240V AC to DC Adapter Power Cord Open Wire Cable with terminal block connector Driver CD & Manual VESA screws
	Power Rating	9V~29V DC with protection fuse
Power	Adapter	12V 84W

**NOTE:**

1. Accessories and Integrated Options may vary depending on your configuration. The product shown in this document is a standard model. For diagrams that contain customized or optional I/O, please contact the Winmate Sales Team for more information.
2. All specifications are subject to change without prior notice.

# Appendix

## Appendix A: System Dimensions

ITMH100

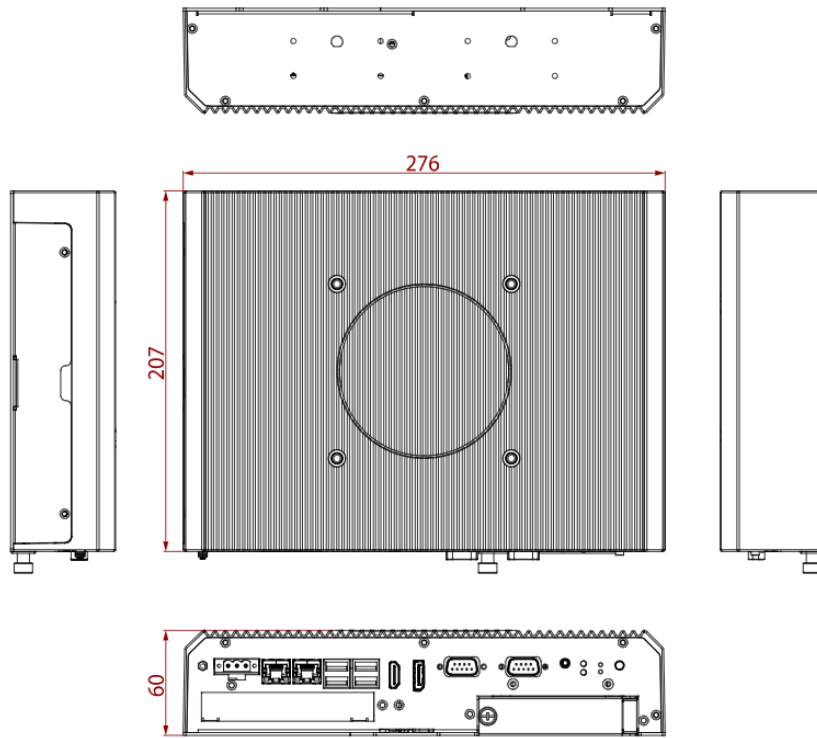

ITMH100-6L

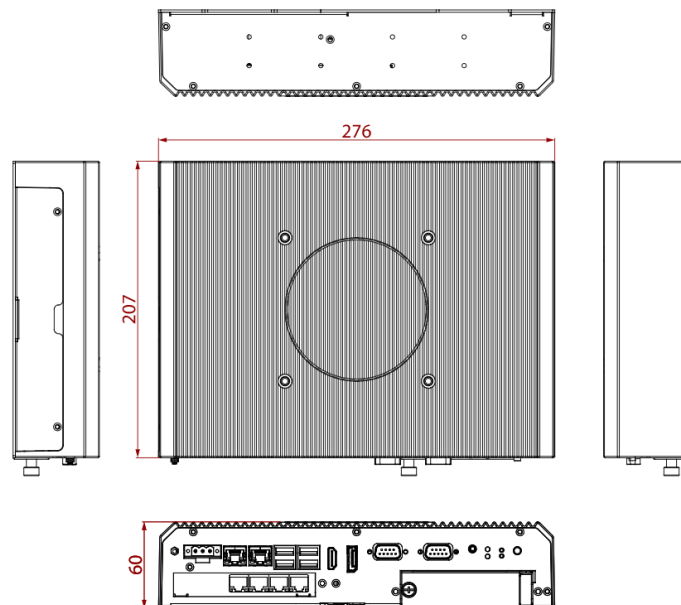

ITMH200

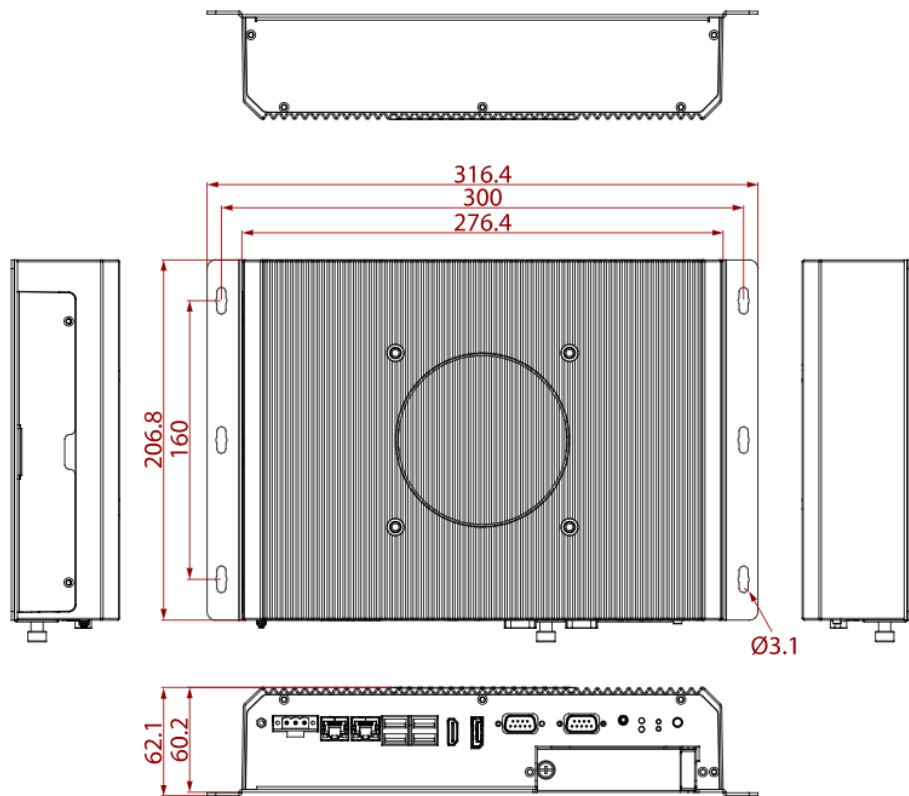

## Appendix B: Software Developer Support

You can download drivers and Software Development Kit (SDK) and Drivers from [Winmate Download Center](#).







