

IP69K Stainless P-Cap

10.4~23.8" Panel PC

Intel® Celeron® Bay Trail-M N2930, 1.83 GHz

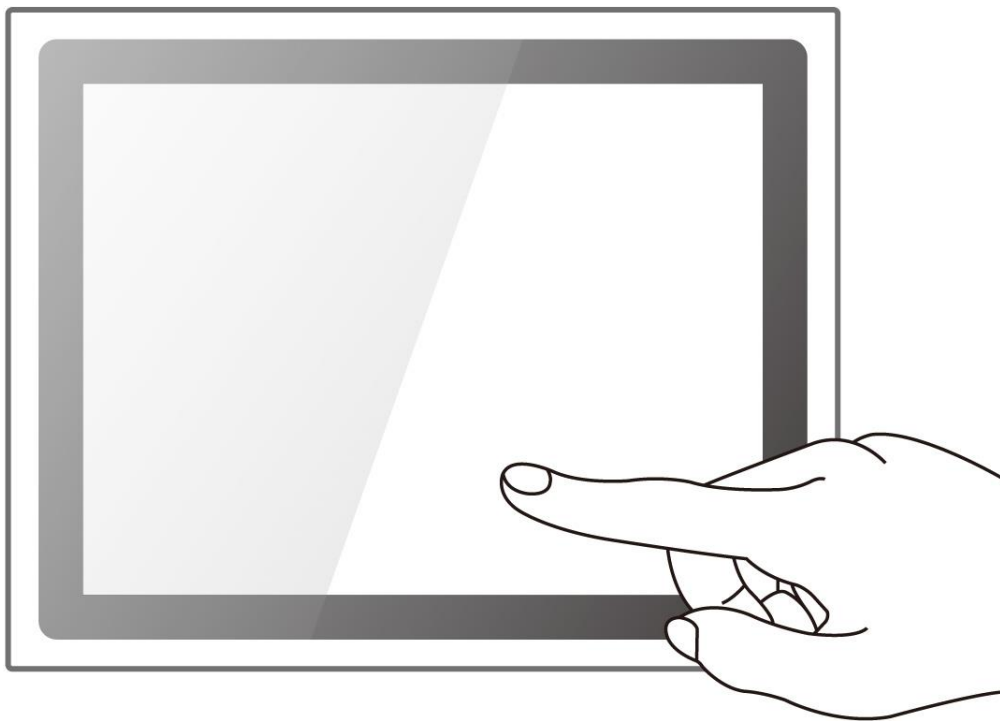

Full IP69K

User Manual

Contents

Preface	3
About This User Manual	8
Chapter 1: Introduction	9
1.1 Product Features.....	9
1.2 Package Content.....	10
1.3 Connector Placement.....	11
1.4 Physical Buttons and LED Indicators	12
1.5 Schematics and Dimensions	12
1.5.1 Dimensions 10.4".....	13
1.5.2 Dimensions 15".....	13
1.5.3 Dimensions 19".....	14
1.5.4 Dimensions 21.5".....	14
1.5.5 Dimensions 23.8".....	15
Chapter 2: Getting Started	16
2.1 Powering On	16
2.1.1 AC Adapter Components.....	16
2.1.2 Power Considerations.....	17
2.1.3 Power Consumption	17
2.1.4 Connecting the Power	18
2.2 Connector Pin Assignments	19
2.2.1 Power Cable	19
2.2.2 Serial Cable.....	19
2.2.3 Ethernet Cable.....	21
2.2.4 USB 2.0 Cable.....	21
2.3 Turning On and Off.....	22
2.4 Cleaning the Monitor	22
Chapter 3: Operating the Device	23
3.1 Operating System.....	23
3.2 Multi-Touch	23
3.3 How to Enable Watchdog.....	27
Chapter 4: AMI UEFI BIOS Setup	30
4.1 When and How to Use BIOS Setup.....	30
4.2 BIOS Functions	30

4.2.1 Main Menu.....	32
4.2.2 Advanced Menu.....	33
4.2.3 Chipset Menu	51
4.2.4 Security Menu.....	52
4.2.5 Boot Configuration.....	53
4.2.6 Save & Exit.....	55
4.3 Using Recovery Wizard to Restore Computer.....	57
Chapter 5: Driver Installation	60
5.1 Installing Chipset Driver	60
5.2 Installing Graphics Driver	62
5.3 Installing Intel Sideband Fabric Device (Intel MBI) Driver	63
5.4 Installing Intel Trusted Engine Interface (Intel TXE) Driver.....	64
5.5 Installing Intel Network Connections	65
5.6 Installing Audio Driver	66
Chapter 6: Mounting	67
6.1 Cable Mounting Considerations	67
6.2 Safety Precautions	67
6.3 Mounting Guide.....	68
6.3.1 VESA Mount.....	68
6.3.2 Yoke Mount	69
Chapter 7: Technical Support.....	70
7.1 Software Developer Support	70
7.2 Problem Report Form.....	71
Appendix A: Product Specifications	72
Appendix B: Order Information	74

Preface

Copyright Notice

No part of this document may be reproduced, copied, translated, or transmitted in any form or by any means, electronic or mechanical, for any purpose, without the prior written permission of the original manufacturer.

Trademark Acknowledgement

Brand and product names are trademarks or registered trademarks of their respective owners.

Disclaimer

Winmate Inc. reserve the right to make changes, without notice, to any product, including circuits and/or software described or contained in this manual in order to improve design and/or performance. We assume no responsibility or liability for the use of the described product(s) conveys no license or title under any patent, copyright, or masks work rights to these products, and make no representations or warranties that these products are free from patent, copyright, or mask work right infringement, unless otherwise specified. Applications that are described in this manual are for illustration purposes only. We make no representation or guarantee that such application will be suitable for the specified use without further testing or modification.

Warranty

Winmate Inc. warranty guarantees that each of its products will be free from material and workmanship defects for a period of one year from the invoice date. If the customer discovers a defect, we will, at his/her option, repair or replace the defective product at no charge to the customer, provide it is returned during the warranty period of one year, with transportation charges prepaid. The returned product must be properly packaged in its original packaging to obtain warranty service. If the serial number and the product shipping data differ by over 30 days, the in-warranty service will be made according to the shipping date. In the serial numbers the third and fourth two digits give the year of manufacture, and the fifth digit means the month (e. g., with A for October, B for November and C for December).

For example, the serial number 1W14Axxxxxxx means October of year 2014.

Customer Service

We provide a service guide for any problem by the following steps: First, visit the website of our distributor to find the update information about the product. Second, contact with your distributor, sales representative, or our customer service center for technical support if you need additional assistance.

You may need the following information ready before you call:

- Product serial number
- Software (OS, version, application software, etc.)
- Description of complete problem
- The exact wording of any error messages

In addition, free technical support is available from our engineers every business day. We are always ready to give advice on application requirements or specific information on the installation and operation of any of our products.

Advisory Conventions

Four types of advisories are used throughout the user manual to provide helpful information or to alert you to the potential for hardware damage or personal injury. These are Notes, Important, Cautions, and Warnings. The following is an example of each type of advisory.



NOTE:

A note is used to emphasize helpful information



IMPORTANT:

An important note indicates information that is important for you to know.



CAUTION/ ATTENTION

A Caution alert indicates potential damage to hardware and explains how to avoid the potential problem.

Une alerte d'attention indique un dommage possible à l'équipement et explique comment éviter le problème potentiel.



WARNING!/ AVERTISSEMENT!

An Electrical Shock Warning indicates the potential harm from electrical hazards and how to avoid the potential problem.

Un Avertissement de Choc Électrique indique le potentiel de chocs sur des emplacements électriques et comment éviter ces problèmes.

ALTERNATING CURRENT / MISE À LE TERRE!



The Protective Conductor Terminal (Earth Ground) symbol indicates the potential risk of serious electrical shock due to improper grounding.

Le symbole de Mise à Terre indique le risqué potentiel de choc électrique grave à la terre incorrecte.

Safety Information

WARNING! / AVERTISSEMENT!



Always completely disconnect the power cord from your chassis whenever you work with the hardware. Do not make connections while the power is on. Sensitive electronic components can be damaged by sudden power surges. Only experienced electronics personnel should open the PC chassis.

Toujours débrancher le cordon d'alimentation du chassis lorsque vous travaillez sur celui-ci. Ne pas brancher de connexions lorsque l'alimentation est présente. Des composantes électroniques sensibles peuvent être endommagées par des sauts d'alimentation. Seulement du personnel expérimenté devrait ouvrir ces chassis.

CAUTION/ATTENTION



Always ground yourself to remove any static charge before touching the CPU card. Modern electronic devices are very sensitive to static electric charges. As a safety precaution, use a grounding wrist strap at all times. Place all electronic components in a static-dissipative surface or static-shielded bag when they are not in the chassis. Toujours vérifier votre mise à la terre afin d'éliminer toute charge statique avant de toucher la carte CPU. Les équipements électroniques modernes sont très sensibles aux décharges d'électricité statique. Toujours utiliser un bracelet de mise à la terre comme précaution. Placer toutes les composantes électroniques sur une surface conçue pour dissiper les charges, ou dans un sac anti-statique lorsqu'elles ne sont pas dans le chassis.

Safety Precautions

For your safety carefully read all the safety instructions before using the device. Keep this user manual for future reference.

- Always disconnect this equipment from any AC outlet before cleaning. Do not use liquid or spray detergents for cleaning. Use a damp cloth.
- For pluggable equipment, the power outlet must be installed near the equipment and must be easily accessible.
- Keep this equipment away from humidity.
- Put this equipment on a reliable surface during installation. Dropping it or letting it fall could cause damage.
- The openings on the enclosure are for air convection and to protect the equipment from overheating.



CAUTION/ATTENTION

Do not cover the openings!
Ne pas couvrir les ouvertures!

- Before connecting the equipment to the power outlet make sure the voltage of the power source is correct.
- Position the power cord so that people cannot step on it. Do not place anything over the

power cord.

- If the equipment is not used for a long time, disconnect it from the power source to avoid damage by transient over-voltage.
- Never pour any liquid into an opening. This could cause fire or electrical shock.
- Never open the equipment. For safety reasons, only qualified service personnel should open the equipment.
- All cautions and warnings on the equipment should be noted.

***Let service personnel to check the equipment in case any of the following problems appear:**

- The power cord or plug is damaged.
- Liquid has penetrated into the equipment.
- The equipment has been exposed to moisture.
- The equipment does not work well or you cannot get it to work according to the user manual.
- The equipment has been dropped and damaged.
- The equipment has obvious signs of breakage.
- Do not leave this equipment in an uncontrolled environment where the storage temperature is below -20°C (-4°F) or above 60°C (140°F). It may damage the equipment.



CAUTION/ATTENTION

Use the recommended mounting apparatus to avoid risk of injury.

Utiliser l'appareil de fixation recommandé pour éliminer le risque de blessure.



WARNING! / AVERTISSEMENT!

Only use the connection cords that come with the product. When in doubt, please contact the manufacturer.

Utiliser seulement les cordons d'alimentation fournis avec le produit. Si vous doutez de leur provenance, contactez le manufacturier.



WARNING! / AVERTISSEMENT!

Always ground yourself against electrostatic damage to the device.

Toujours vérifier votre mise à la terre afin que l'équipement ne se décharge pas sur vous.

- Cover workstations with approved anti-static material. Use a wrist strap connected to a work surface and properly grounded tools and equipment.
- Use anti-static mats, heel straps, or air ionizer for added protection.
- Handle electrostatic-sensitive components, PCB's and assemblies by the case or the edge of the board.
- Avoid contact with pins, leads, or circuitry.
- Turn off power and input signals before inserting and removing connectors or test equipment.

- Keep the work area free of non-conductive materials, such as ordinary plastic assembly aids and Styrofoam.
- Use filed service tools, such as cutters, screwdrivers, and vacuum cleaners that are conductive.
- Always put drivers and PCB's component side on anti-static foam.

Important Information

Federal Communications Commission Radio Frequency Interface Statement



This device complies with part 15 FCC rules.

Operation is subject to the following two conditions:

- This device may not cause harmful interference.
- This device must accept any interference received including interference that may cause undesired operation.

This equipment has been tested and found to comply with the limits for a class "B" digital device, pursuant to part 15 of the FCC rules. These limits are designed to provide reasonable protection against harmful interference when the equipment is operated in a commercial environment. This equipment generates, uses, and can radiate radio frequency energy and, if not installed and used in accordance with the instruction manual, may cause harmful interference to radio communications. Operation of this equipment in a residential area is likely to cause harmful interference in which case the user will be required to correct the interference at his own expense.

European Union



This equipment is in conformity with the requirement of the following EU legislations and harmonized standards. Product also complies with the Council directions.

Electromagnetic Compatibility Directive (2014/30/EU)

- EN55024: 2010/ A1: 2015
 - IEC61000-4-2: 2009
 - IEC61000-4-3: 2006+A1: 2007+A2: 2010
 - IEC61000-4-4: 2012
 - IEC61000-4-5: 2014
 - IEC61000-4-6: 2014
 - IEC61000-4-8: 2010
 - IEC61000-4-11: 2004
- EN55032: 2012/AC:2013
- EN61000-3-2:2014
- EN61000-3-3:2013

Low Voltage Directive (2014/35/EU)

- EN 60950-1:2006/A11:2009/A1:2010/A12:2011/ A2:201

About This User Manual

This User Manual provides information about using the Winmate® IP69K Stainless P-Cap Panel PC with Intel® Celeron® Bay Trail-M N2930 1.83 GHz processor. This User Manual applies to the IP69K Flat Stainless P-CAP Panel PC – R10IB3S-SPT269, R15IB3S-SPC369, R19IB3S-SPM169, W22IB3S-SPA369, and W24IB3S-SPA269.

The documentation set for the IP69K Flat Stainless P-CAP Panel PC provides information for specific user needs, and includes:

- **IP69K Stainless P-Cap Panel PC User Manual** – contains detailed description on how to use the Panel PC, its components and features.
- **IP69K Stainless P-Cap Panel PC Quick Start Guide** - contains detailed description on how to use the Panel PC, its components and features.



NOTE:

Some pictures in this guide are samples and can differ from actual product.

Chapter 1: Introduction

Congratulations on purchasing Winmate® IP69K Stainless P-Cap Panel PC.

Winmate flat stainless steel P-Cap panel PCs and display are designed for applications with high hygienic requirements. IP69K series is completely waterproof with IP69K level of protection allowing for easy cleaning and sterilization.

The IP69K stainless series work well in food, beverage industry, including food processing operations and packaging, chemical manufacturing and other industrial applications.

1.1 Product Features

The IP69K Stainless P-Cap Panel PC features:

- Intel® Celeron® Bay Trail-M N2930, 1.83 GHz
- SUS 316/ AISI 316 stainless steel for food and chemical industries
- Full IP69K waterproof enclosure, good corrosion resistance
- A true flat, easy-to-clean front surface with edge-to-edge design
- Flat multi-touch panel pc with superior readability and P-CAP technology
- Various mounting solutions, Yoke mount and VESA mount
- Plenty of I/O s including USB 2.0, RS-232 serial port and RJ45-10/100/1000 LAN ports
- Waterproof ports with adapter cables for external connectivity
- Supports VESA mount
- Supports Rain/ Glove mode (Optional)

1.2 Package Content

Carefully remove the box and unpack your Panel PC. Please check if all the items listed below are inside your package. If any of these items are missing or damaged contact us immediately.

Factory shipment list:

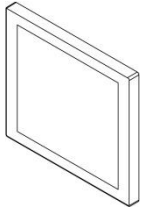

Panel PC	Quick Start Guide (Hardcopy)	Driver CD & User Manual
Varies by product specifications	915211101030	IB32: 9171111101Y

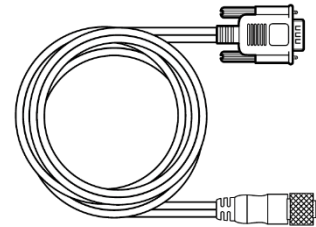
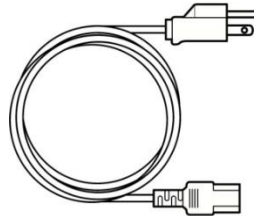
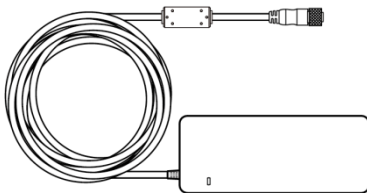

AC Adapter	Power Cable*	Serial Cable
50W 90PO12050002 80W 90PO12080003	Varies by destination	94G0103090Q0

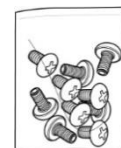
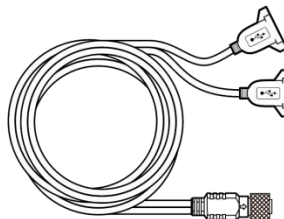
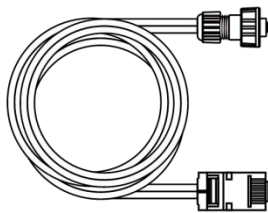

Ethernet Cable	USB Cable	VESA Screws
94I0080080KF	9480108080Q0	913511101101

1.3 Connector Placement

IP69K Flat Stainless P-CAP Panel PC has M12 type connectors with protection cap and air venting valve.

For cable specifications refer to the 2.2 *Connector Pin Assignments* of this user manual.

Air Venting Valve

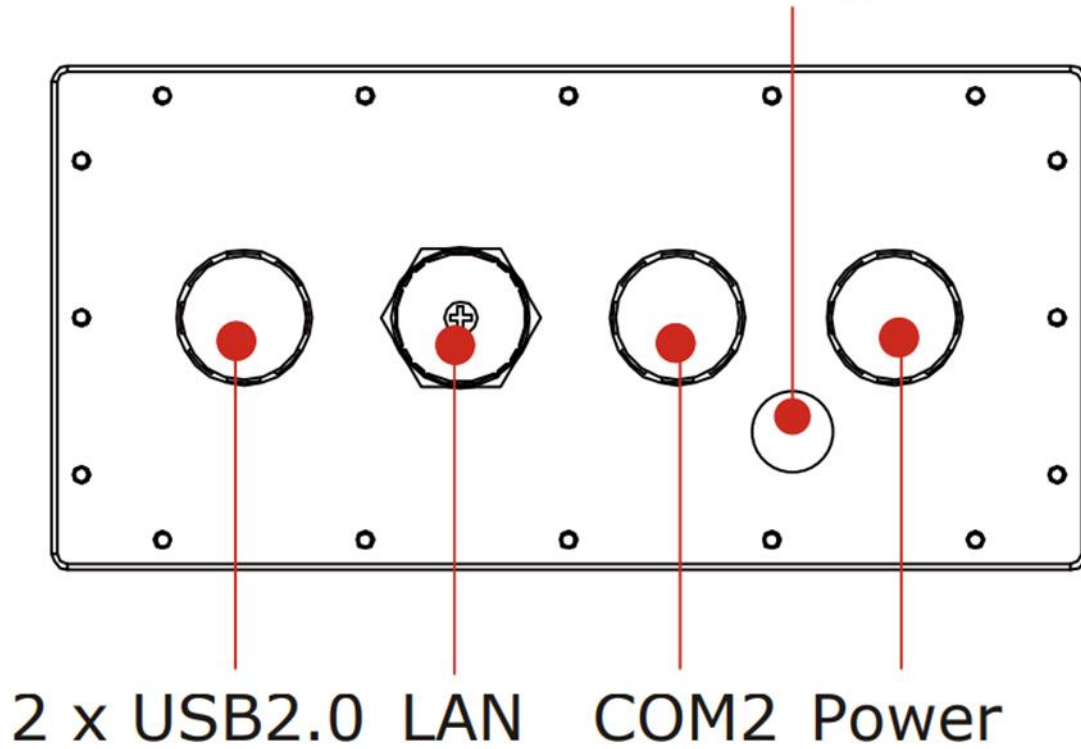



1.4 Physical Buttons and LED Indicators

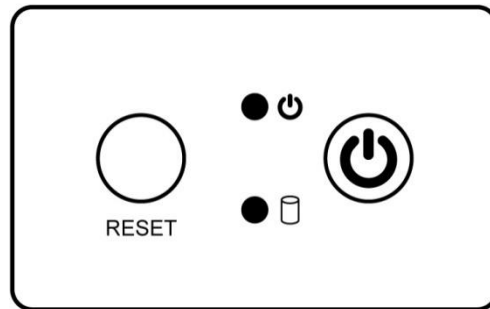

Physical buttons and LED indicators located on the rear side of the Panel PC.

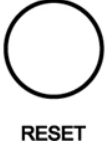

Physical Buttons

Icon	Button	Description
	Reset	Press to reset the system
	Power On/ Off	Press to power on or power off the device

LED Indicators

LED Type	Status	Description
	On	Power is on
	Off	Power is off
	Blinking	Storage activity (Data is being read or written)
	Off	System is idle

1.5 Schematics and Dimensions

This section contains mechanical drawing of the panel PC. Notice that this is a simplified drawing and some components are not marked in detail.

1.5.1 Dimensions 10.4"

Unit: mm

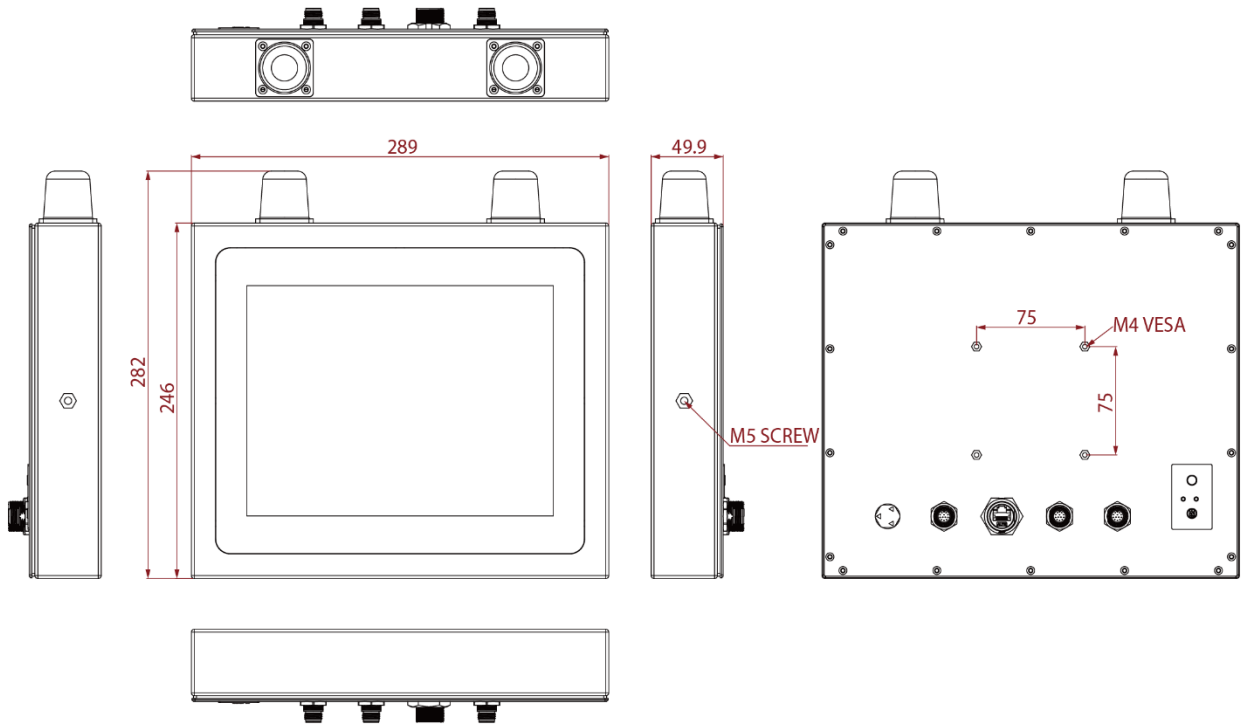

1.5.2 Dimensions 15"

Unit: mm

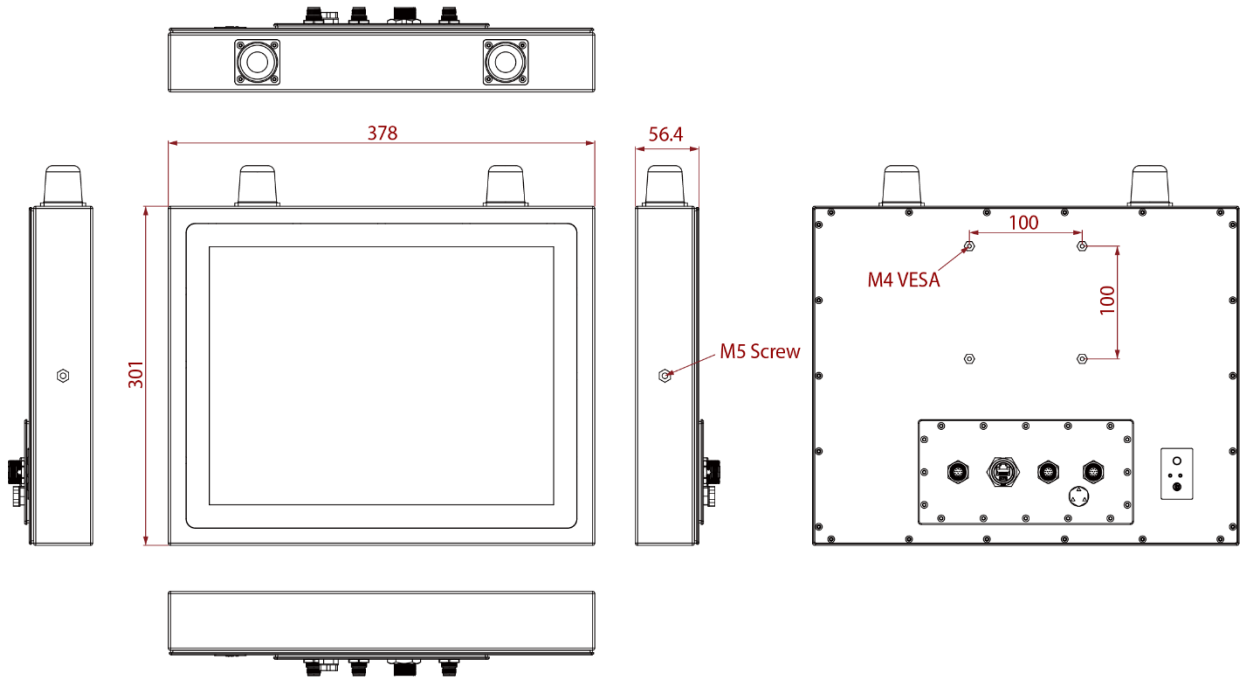

1.5.3 Dimensions 19"

Unit: mm

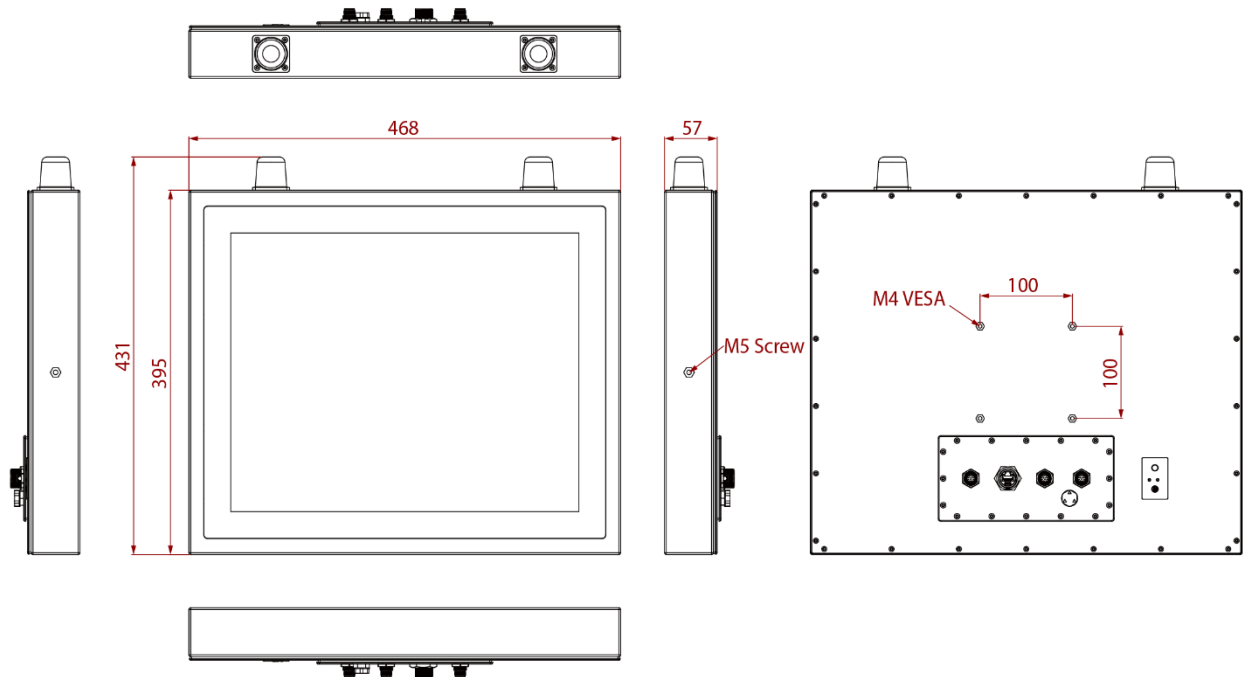

1.5.4 Dimensions 21.5"

Unit: mm

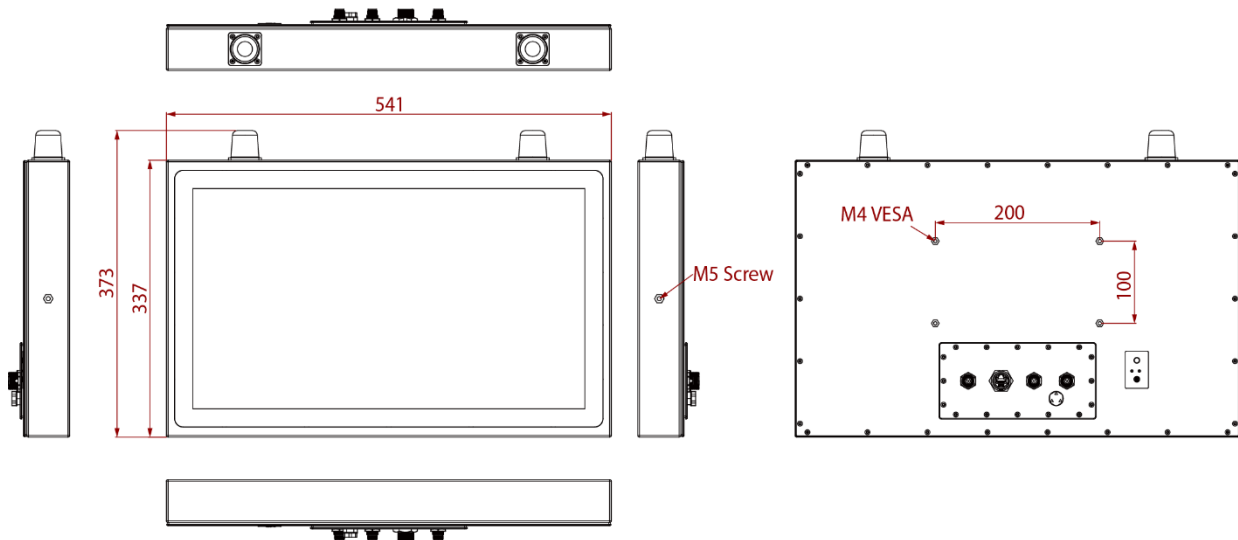

1.5.5 Dimensions 23.8"

Unit: mm

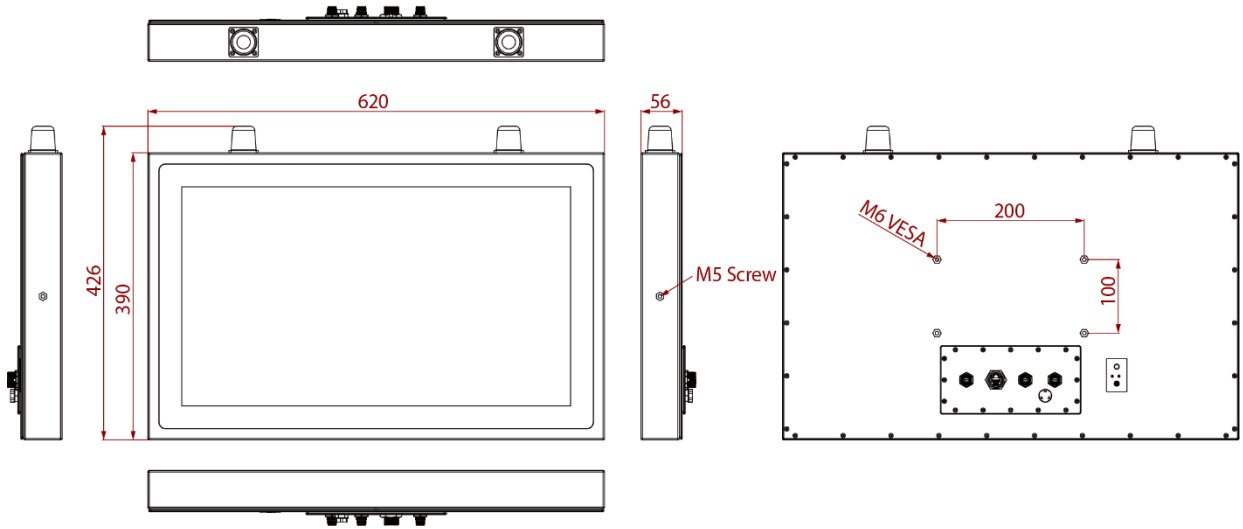

Chapter 2: Getting Started

This chapter provides information on how to connect the panel PC to the source of power, connector pinouts and the guideline to turn on/off the Panel PC.

2.1 Powering On

2.1.1 AC Adapter Components

AC Adapter supplied with the power cord.

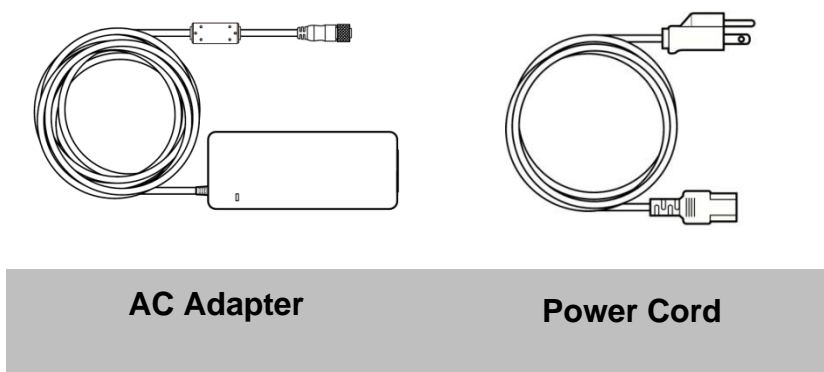

AC Adapter specifications vary by panel size.

Size	10.4"	15"	19"	21.5"	23.8"
AC Adapter	12V/ 50W	12V/ 80W	12V/ 80W	12V/ 80W	12V/ 80W

Safety Precautions:

- Do not use the adapter in a high moisture environment
- Never touch the adapter with wet hands or foot
- Allow adequate ventilation around adapter while using
- Do not cover the adapter with paper or other objects that will reduce cooling
- Do not use the adapter while it is inside a carrying case
- Do not use the adapter if the cord is damaged
- There are NO serviceable parts inside
- Replace the unit if it is damaged or exposed to excess moisture

While using the AC Adapter always:

- Plug-in the power cord to easy accessible AC outlet
- Plug-in the AC adapter to a grounded outlet



ALTERNATING CURRENT / MISE À LE TERRE!

This product must be grounded. Use only a grounded AC outlet. Install the additional PE ground wire if the local installation regulations require it.

**If you do not use a grounded outlet while using the device, you may notice an electrical tingling sensation when the palms of your hands touch the device.*

Ce produit doit être mis à la terre. Utiliser seulement un cordon d'alimentation avec mise à la terre. Si les règlements locaux le requiert, installer des câbles de mise à la terre supplémentaires.

**Si vous n'utilisez pas une prise d'alimentation avec mise à la terre, vous pourriez remarquer une sensation de picotement électrique quand la paume de vos mains touche à l'appareil.*

2.1.2 Power Considerations

The Panel PC operates on external DC power. Use the AC adapter included in the package.



CAUTION/ATTENTION

Use only the AC adapter included in your package. Using other AC adapters may damage the device.

Utiliser seulement le convertisseur AC inclu avec votre appareil. Utiliser d'autres convertisseurs pourraient endommager l'appareil.

2.1.3 Power Consumption

The table below shows power consumption and AC adapter for the Flat Stainless P-CAP Panel PC.

Size	10.4"	15"	19"	21.5"	23.8"
Power Consumption*	33W (typ.)	38W (typ.)	45W (typ.)	56W (typ.)	56W (typ.)

**With maximum backlight and high CPU load.*

2.1.4 Connecting the Power

Cable Mounting Steps:

1. Connect the AC adapter to the DC-in jack connector located on the back side of the Panel PC.
2. Connect the power cord to AC adapter.
3. Plug the power cord to the AC outlet and the device will turn on automatically.

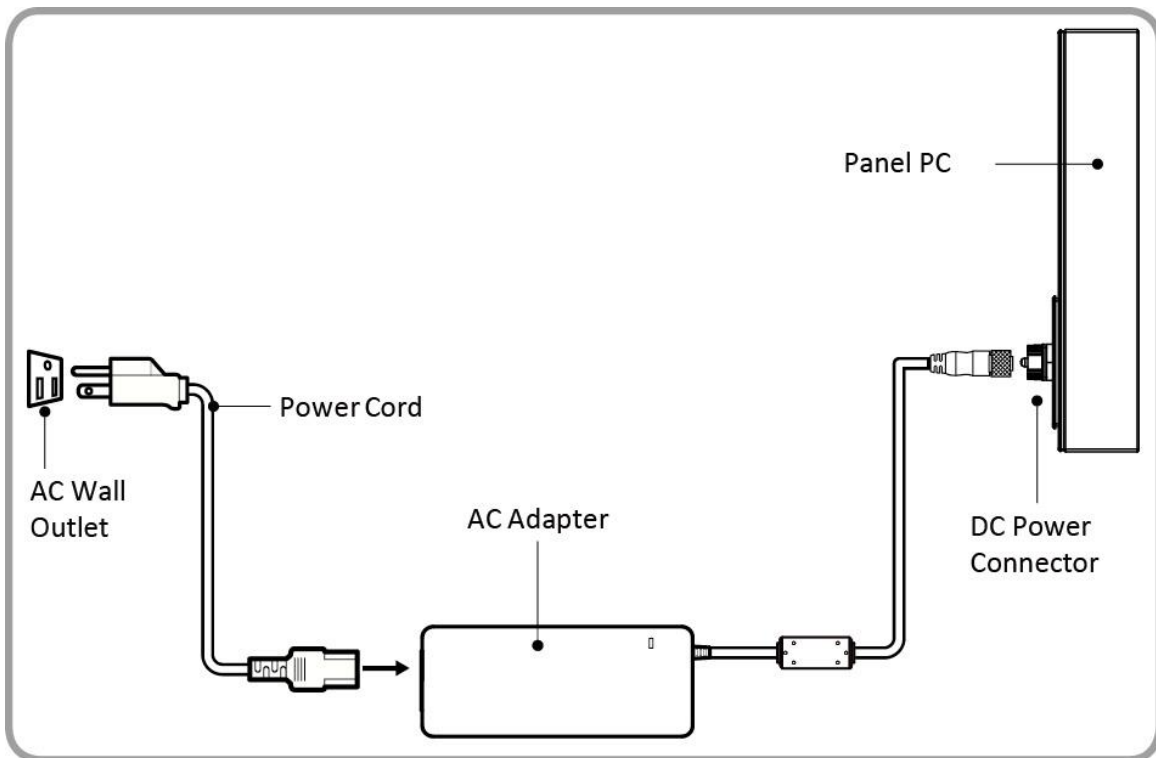
**NOTE:**

Power cords vary in appearance by region and country.

2.2 Connector Pin Assignments

This Panel PC is equipped with four M12 type waterproof connectors. Use only the cables that are included in the package. The pin assignments of the cables are as follows.

2.2.1 Power Cable

The IP69K Stainless P-CAP Panel PC has M12 type connector. Use power cable to connect Panel PC to the source of power.

IP69K Stainless P-CAP Panel PC support 12V DC power input.

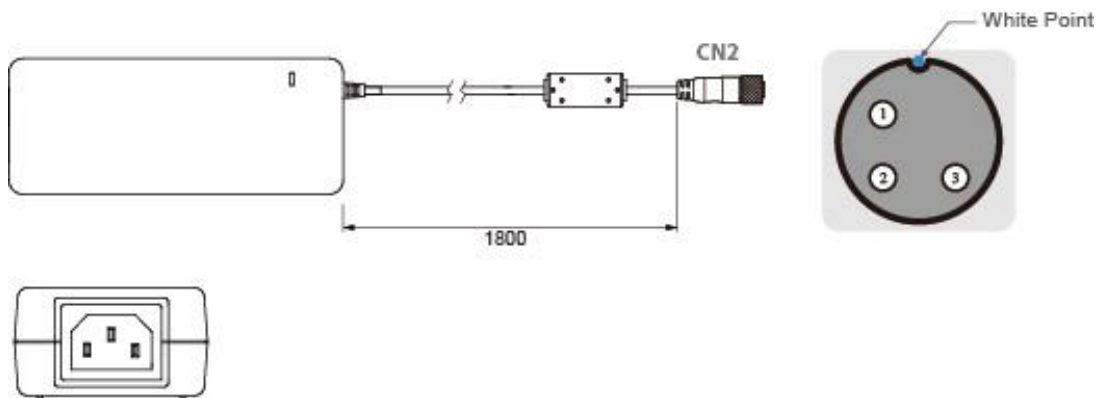

Pin No.	Symbols	Color		Pin No.	Symbols	Color
CN1-1	VIN -	NO ASSIGN	↔	CN2-1	VCC+	Flow Adapter
CN1-2	VIN -	NO ASSIGN	↔	CN2-2	GND	Flow Adapter
CN1-3	VIN -	NO ASSIGN	↔	CN2-3	VCC -	Flow Adapter

2.2.2 Serial Cable

The IP69K Stainless P-CAP Panel PC has M12 type serial port connector. Use serial cable to connect serial interfaces.

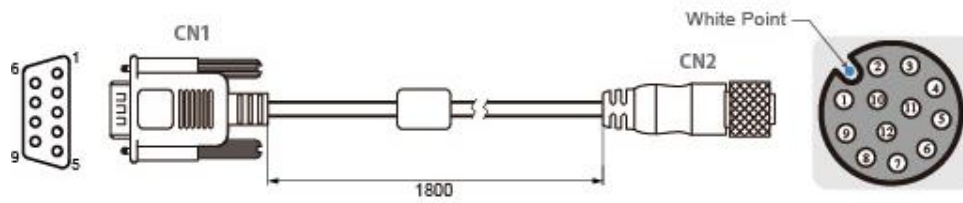

Pin No.	Symbols	Color		Pin No.	Symbols	Color
CN1-1	DCD-CON2	Green	↔	CN2-1	DCD-CON2	Green
CN1-6	DSR-CON2	Brown	↔	CN2-2	DSR-CON2	Brown
CN1-2	RXD-CON2	Red	↔	CN2-3	RXD-CON2	Red
CN1-7	RTS-CON2	Orange	↔	CN2-4	RTS-CON2	Orange
CN1-3	TXD-CON2	Blue	↔	CN2-5	TXD-CON2	Blue
CN1-8	CTS-CON2	White	↔	CN2-6	CTS-CON2	White
CN1-4	DTR-CON2	Purple	↔	CN2-7	DTR-CON2	Purple
CN1-9	RI-CON2	Yellow	↔	CN2-8	RI-CON2	Yellow
CN1-5	GND-CON2	Black	↔	CN2-9	GND-CON2	Black

2.2.3 Ethernet Cable

The IP69K Stainless P-CAP Panel PC has M12 type Ethernet connector. Use Ethernet cable to connect the Panel PC to the Internet.

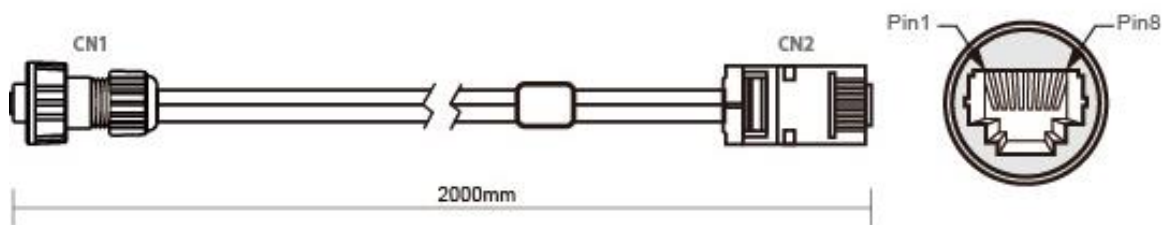

Plug	Wire Color	Conn.	
1	Orange / White	1	Twist
2	Orange	2	
3	Green / White	3	Twist
4	Blue	4	
5	Blue / White	5	
6	Green	6	Twist
7	Brown / White	7	
8	Brown	8	

2.2.4 USB 2.0 Cable

The IP69K Stainless P-CAP Panel PC has one M12 type USB2.0 connector. Use USB2.0 cable to connect external devices such as mouse or keyboard to the Panel PC.

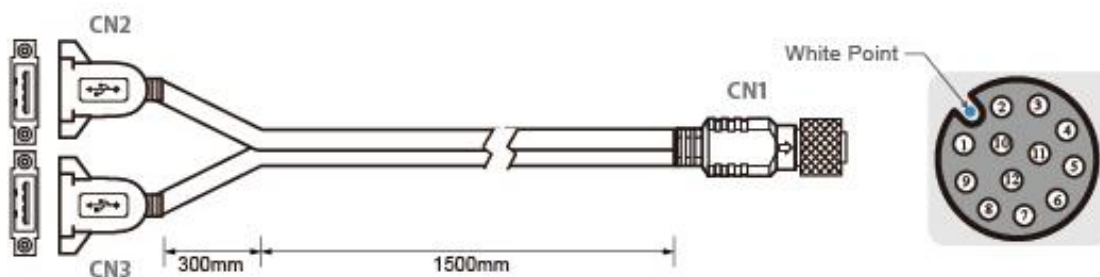

Pin No.	Symbols	Color		Pin No.	Symbols	Color	
CN1-2	VCC	RED	↔	CN2-1	VCC	RED	twisted pair
CN1-3	D-	WHITE	↔	CN2-2	D-	WHITE	
CN1-4	D+	GREEN	↔	CN2-3	D+	GREEN	
CN1-5	GND	BLACK	↔	CN2-4	GND	BLACK	
CN1-6	VCC	RED	↔	CN3-1	VCC	RED	twisted pair
CN1-7	D-	WHITE	↔	CN3-2	D-	WHITE	
CN1-8	D+	GREEN	↔	CN3-3	D+	GREEN	
CN1-9	GND	BLACK	↔	CN3-4	GND	BLACK	
CN1-1	GND	Braid	↔	Braid connect to the housing			

2.3 Turning On and Off

The unit is configured to **Power ON** when is connected to the power source (refer to [Ch.2, "Powering On"](#) section of this user manual for more details on how to power on the HMI device).

You can **Turn OFF** the Panel PC with the Windows power settings.

To shut down the device:

1. Tap **Start**  **>Shut down.**
2. Wait for your Panel PC to completely turn off before disconnecting the power cord (if necessary).

2.4 Cleaning the Monitor



NOTE:

The IP69K Stainless Panel PCs withstand regular intense cleaning and could hold up against steam and high-pressure water. The devices are able to sustain water temperatures up to 80°C and a water jet operating at 99.97 bar.

Before cleaning:

- Make sure the device is turned off.
- Disconnect the power cable from any AC outlet.

When cleaning:

- Use water up to 80°C to clean the housing.
- Wipe the screen with a clean, soft, lint-free cloth. This removes dust and other particles.
- The display area is highly prone to scratching. Do not use ketene type material (ex. Acetone), Ethyl alcohol, toluene, ethyl acid or Methyl chloride to clear the panel. It may permanently damage the panel and void the warranty.
- If it is still not clean enough, apply a small amount of non-ammonia, non-alcohol based glass cleaner onto a clean, soft, lint-free cloth, and wipe the screen.
- Don not use oil directly on the display screen. If droplets are allowed to drop on the screen, permanent staining or discoloration may occur.

Chapter 3: Operating the Device

In this chapter you will find instructions on how to operate the Panel PC.

3.1 Operating System

The Panel PCs support several versions of Windows OS: Windows 10 IoT Enterprise, Windows Embedded 8.1 Industry Pro, Windows Embedded 8 Standard, Windows 7 Pro for Embedded Systems, and Windows Embedded Standard 7 – WS7P.









IMPORTANT:

The device is shipped with the OS System according to your order. Contact us if you have any questions regarding OS settings.

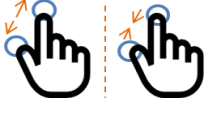
3.2 Multi-Touch

The touchpad supports the core gestures for Windows.

Gesture	Windows Usage	Gesture Action	Action
Tap/ Double-tap	Click / Double-click	Click or double-click	
Panning with Inertia	Scrolling	Drag one or two fingers up and down	
Selection/Drag (left to right with one finger)	Mouse-drag/ Selection	Drag one finger left/right	
Zoom	Zoom (default to CTRL key + scroll wheel)	Move two fingers apart/ toward each other	
Rotate	No system default unless handled by Application (using WM_Gesture API)	Move two fingers in opposite directions or Use one finger to pivot around another	

Gesture	Windows Usage	Gesture Action	Action
Press and Hold	Right-click	Press, wait for blue-ring animation to complete, then release	
Flicks	Default: Pan Up/Down/ Back, and Forward	Make quick drag gestures in the described direction	

*Reference from Microsoft®

IP69K Stainless P-Cap Panel PC has three types touch modes pre-installed with Windows OS.



The icon is on the bottom right corner of the toolbar.

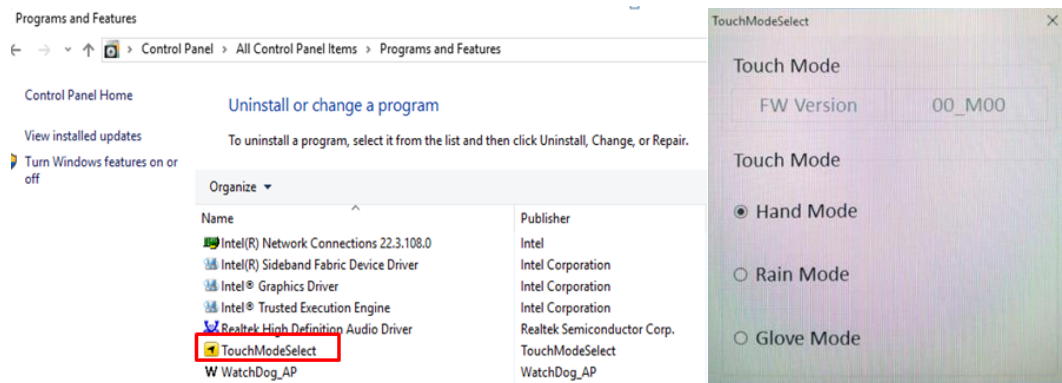

If the OS is not installed, please download the application on our website for switching the touch modes. If you cannot find it, please download it from Winmate Download Center or contact Winmate sales representative.

Follow the instructions below to install the *TouchModeSelect* Utility.

1. Download, install and execute **TouchModeSelect_1.2.3** setup wizard.
2. Click **Next** to continue.

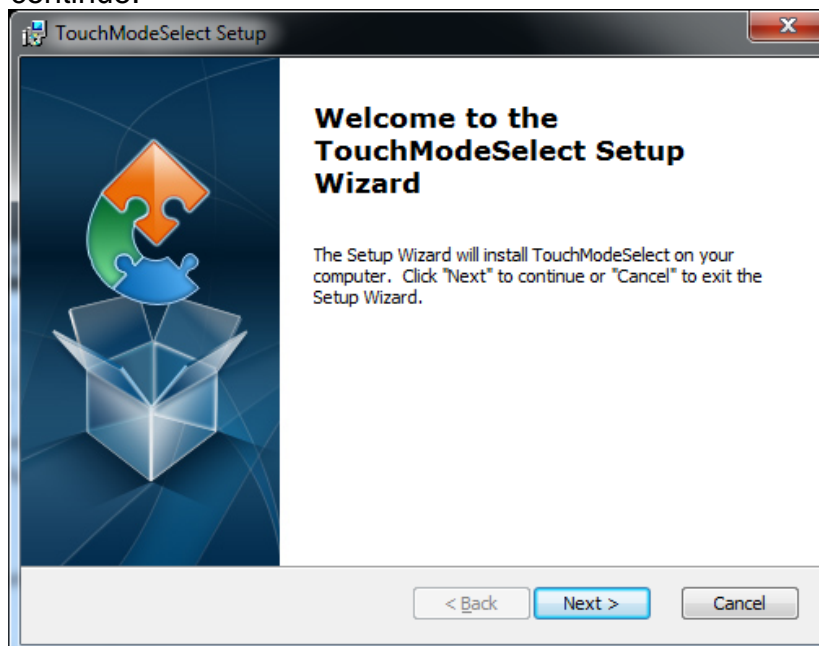

3. Select the installation folder, and click **Next** to continue.

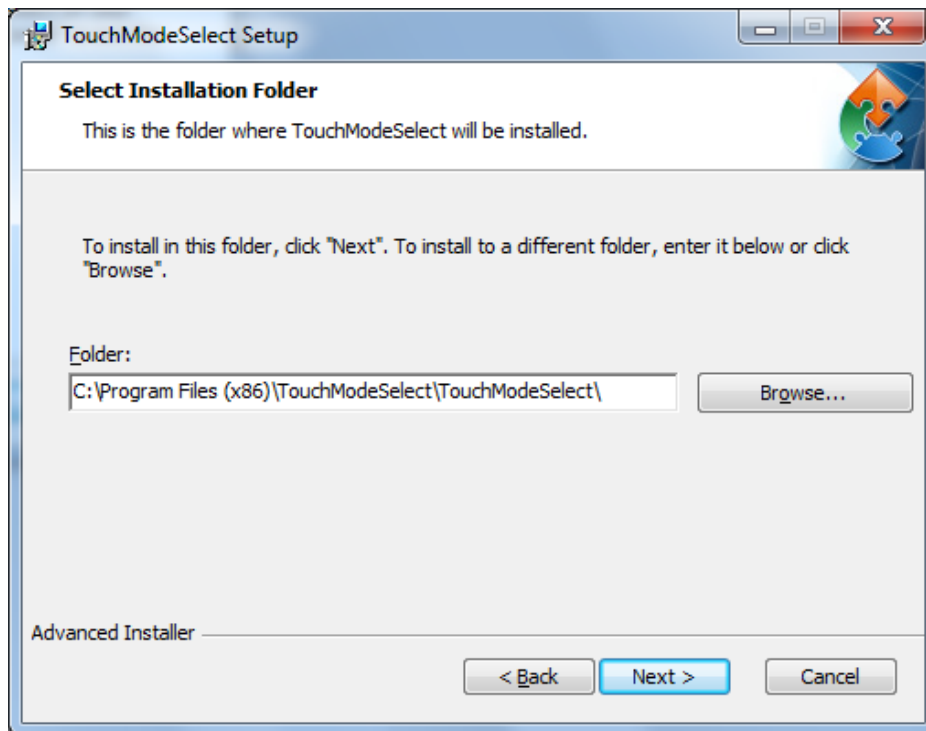

4. The Setup Wizard is ready to begin the **TouchModeSelect** installation. Click **Install** to proceed.

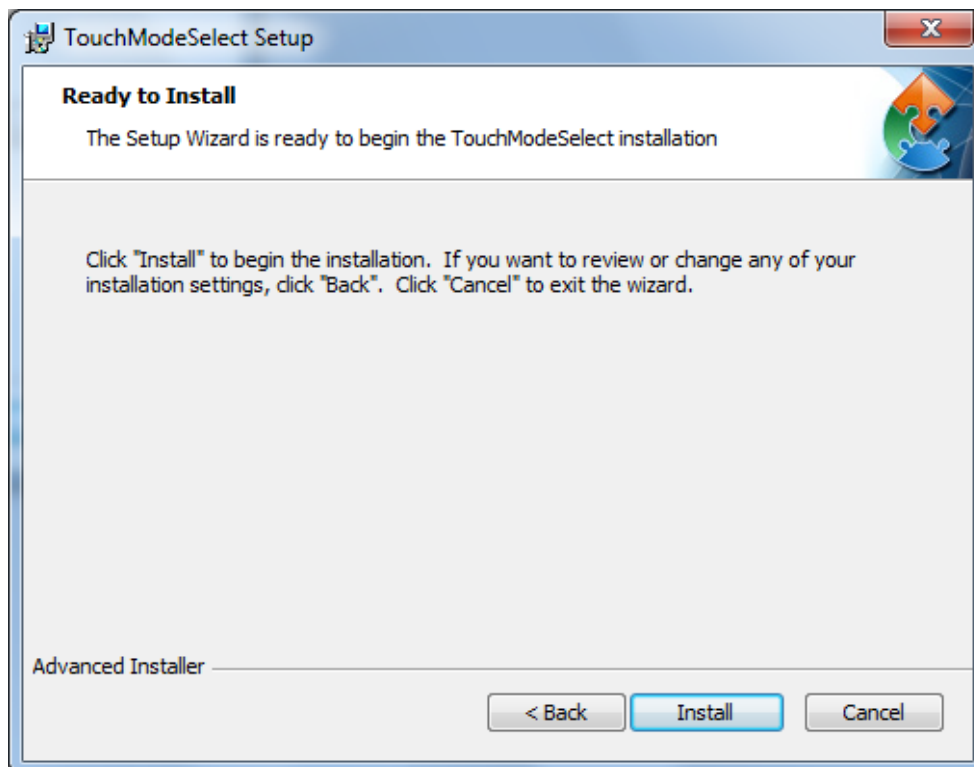

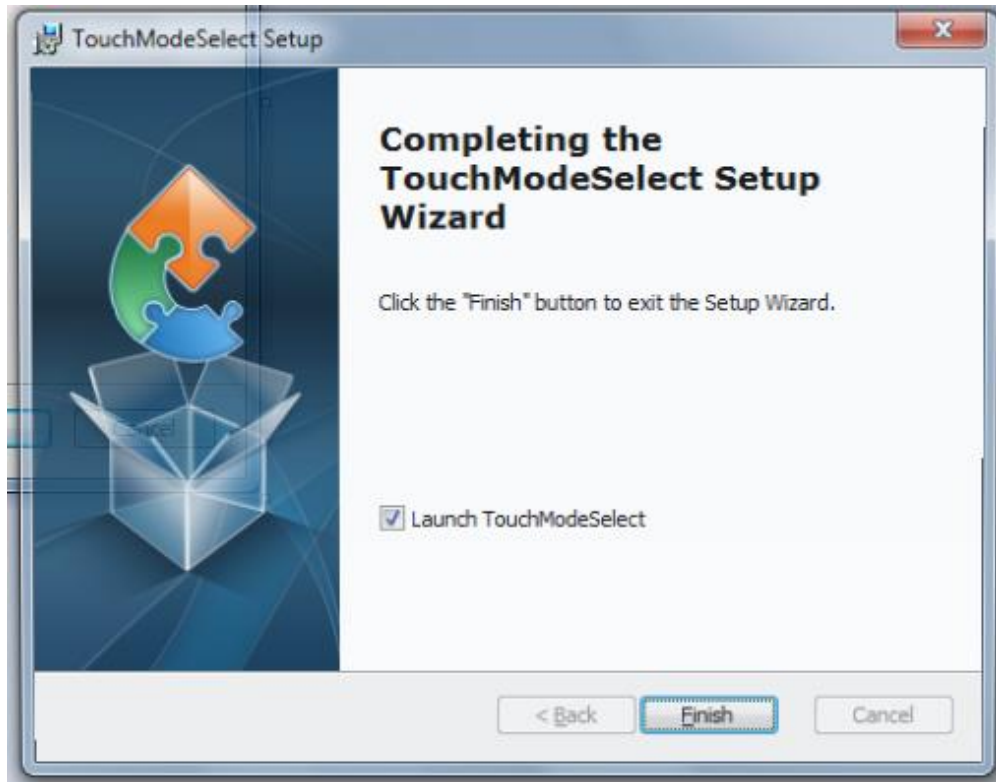

5. When installation is complete, click **Finish** button to exit the Setup Wizard.



3.3 How to Enable Watchdog

To enable Watchdog, you need to download Winmate Watchdog utility. Find more information on Watchdog in “Watchdog Guide” that you can download from Winmate Download Center or File Share. Refer to the [Ch.7, “Technical Support”](#) for more details.

To enable watchdog in Watchdog AP follow the instructions below:

1. On the right bottom side of the desktop screen, click  **triangle button** to show hidden icons.
2. Click  icon to open Watchdog utility.

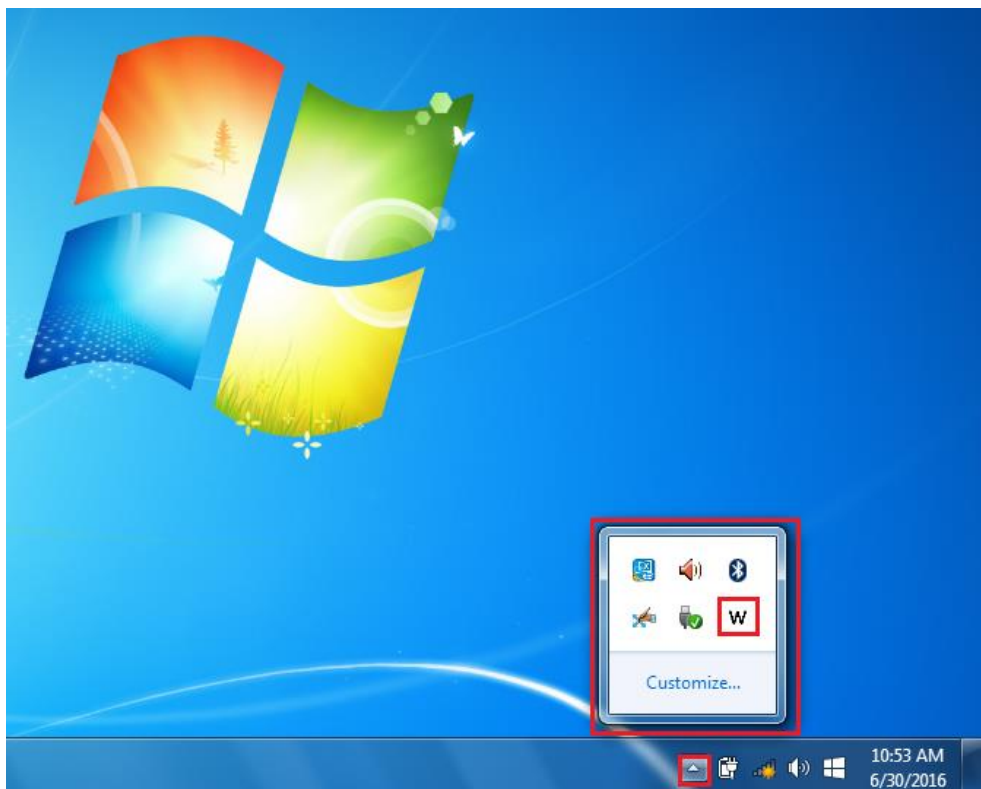

3. In Watchdog utility window set countdown time and periodically feed time, or disable watchdog.

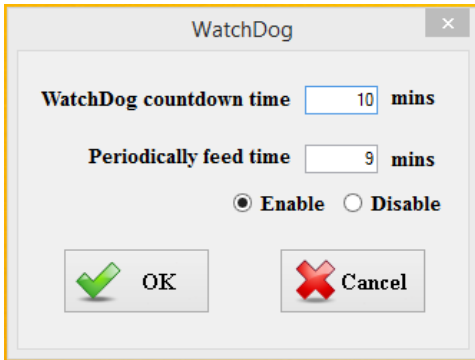

Example:

Every 10 min watchdog will monitor the system, in case any error occurs the system will restart automatically when the countdown time reaches 0.

Every 9 min watchdog timer will be reset to 10 min.

Settings	Description
Watchdog Countdown Time	The system automaticity restarts when this countdown time reaches zero. <i>Default: 10 min</i>
Periodically Feed Time	To set a cycle time to automatically reset watchdog timer. <i>Default: 9 min</i>
Enable / Disable	Enable or disable watchdog. <i>Default: Enable</i>

Chapter 4: AMI UEFI BIOS Setup

BIOS Setup Utility is a program for configuration basic Input / Output system settings of the computer for optimum use. This chapter provides information on how to use BIOS setup, its functions and menu.

4.1 When and How to Use BIOS Setup

To enter the BIOS setup, you need to connect an external USB keyboard, press **** key when the prompt appears on the screen during start up. The prompt screen shows only few seconds, you need to press **** key quickly. If the message disappears before your respond, restart the system by turning it OFF and ON, and enter the BIOS again.



IMPORTANT:

Updated BIOS version may be published after the manual released. Check the latest version of BIOS on the website.

Run BIOS setup utility for:

1. Error message on screen indicates to check BIOS setup
2. Restoring the factory default settings.
3. Modifying the specific hardware specifications
4. Necessity to optimize specifications

4.2 BIOS Functions

BIOS Navigation Keys

BIOS navigation keys for keyboard control are listed below.

The following keys are enabled during POST:

Key	Function
Del	Enters the BIOS setup menu.
F7	Display the boot menu. Lists all bootable devices that are connected to the system. With cursor ↑ and cursor ↓ and by pressing <ENTER>, select the device used for the boot.
Pause	Pressing the [Pause] key stops the POST. Press any other key to resume the POST.

The following Keys can be used after entering the BIOS Setup.

Key	Function
F1	General Help
F2	Previous Values
F3	Optimized Defaults
F4	Save & Exit
Esc	Exit
+/-	Change Opt.
Enter	Select or execute command
Cursor ↑	Moves to the previous item
Cursor ↓	Goes to the next item
Cursor ←	Moves to the previous item
Cursor →	Goes to the next item

**NOTE:**

You can press the F1, F2, F3, F4, +/-, and Esc keys by connecting a USB keyboard to your device.

For items marked ► press <Enter> for more options.

4.2.1 Main Menu

When you enter BIOS setup, the first menu that appears on the screen is the main menu. It contains the system information including BIOS version, processor RC version, system language, time, and date.

Immediately after the **[DEL]** key is pressed during startup, the main BIOS setup menu appears:

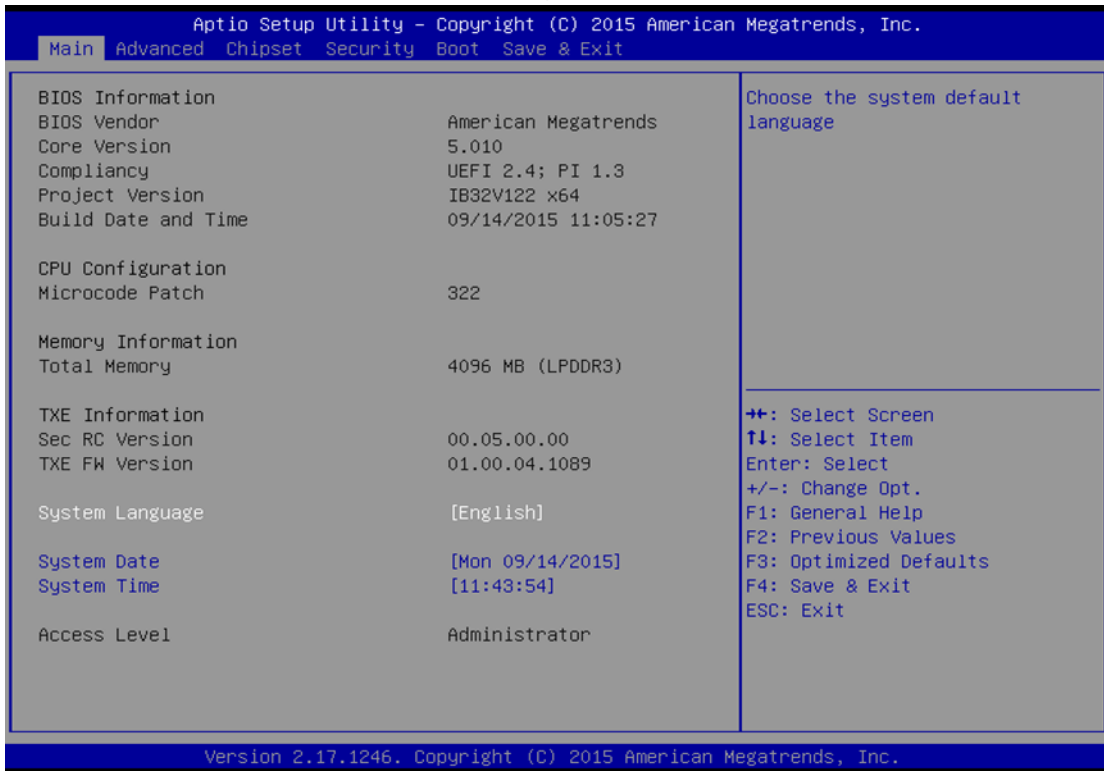

BIOS Setting	Description	Setting Option	Effect
System Language	Displays the system language. [English] is set up by default.	Adjustment of the language	Set the language in other language. The language in this device is English.
System Date/Time	This is current date setting. The time is maintained by the battery when the device is turned off.	Date and time changes.	Set the date in the format [mm/dd/yyyy]; The time in the format: [hh/mm/ss]
Access Level	The current user access settings	Changes to the level of access	Administrator is set up by the default

4.2.2 Advanced Menu

The advanced menu also uses to set configuration of the CPU and other system devices. There are sub menus on the left frame of the screen.



IMPORTANT:

Handle advanced BIOS settings page with caution. Any changes can affect the operation of your computer.

For items marked ► press <Enter> for more options.

Advanced Configuration and Power Interface (ACPI) settings allow to control how the power switch operates. The power supply can be adjusted for power requirements. You can use the screen to select options of ACPI configuration. A description of the selected items will appear on the right side of the screen.

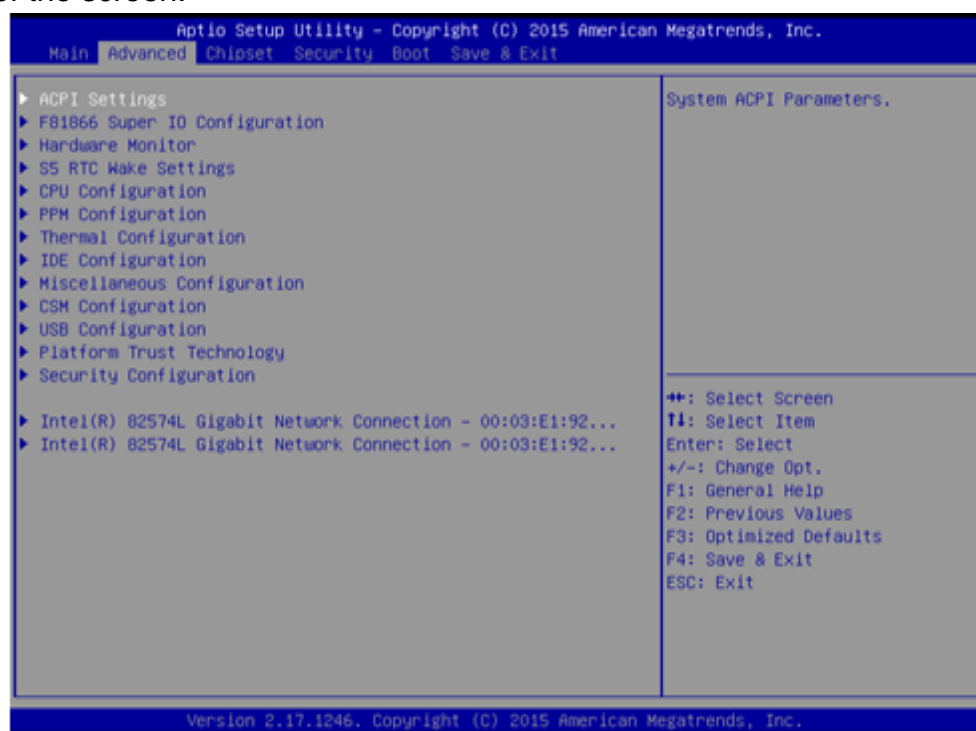

BIOS Setting	Description	Setting Option	Effect
ACPI Settings	Configures ACPI settings	Enter	Opens submenu
F81866 Super IO Configuration	Configures IO settings	Enter	Opens submenu
Hardware Monitor	Configures Hardware Monitor settings	Enter	Opens submenu
S5 RTC Wake Settings	Configures RTC Wake parameters	Enter	Opens submenu
CPU Configuration	Configures CPU settings	Enter	Opens submenu
PPM Configuration	Configures PPM settings	Enter	Opens submenu
Thermal Configuration	Configures Thermal Parameters	Enter	Opens submenu
IDE Configuration	Configures IDE Parameters	Enter	Opens submenu
Miscellaneous Configuration	Configures Miscellaneous Parameters	Enter	Opens submenu
CSM Configuration	Configures CSM Parameters	Enter	Opens submenu
USB Configuration	Configures USB Settings	Enter	Opens submenu
Platform Trust Technology	Configures Platform Trust Technology parameters	Enter	Opens submenu
Security Configuration	Configures Security parameters	Enter	Opens submenu

4.2.2.1 ACPI Settings

Advanced Configuration and Power Interface (ACPI) settings allow to control how the power switch operates. The power supply can be adjusted for power requirements. You can use the screen to select options of ACPI configuration. A description of the selected items will appear on the right side of the screen.

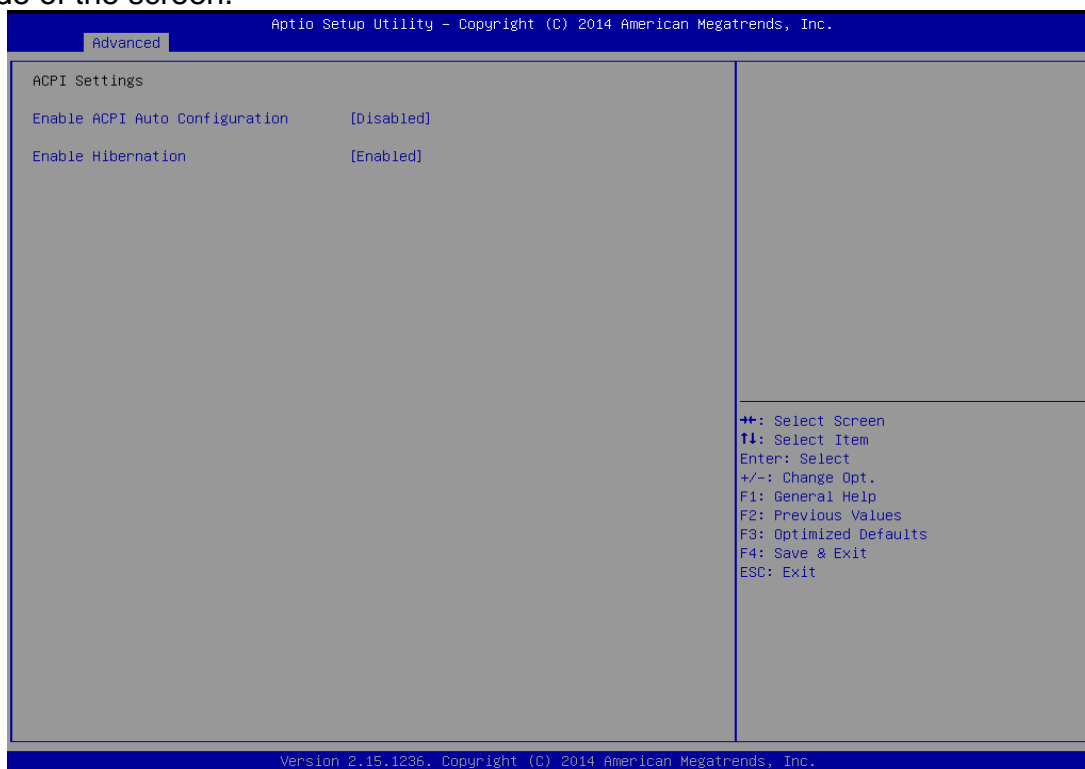

BIOS Setting	Description	Setting Option	Effect
Enable ACPI Auto Configuration	BIOS ACPI Auto Configuration	Enable/ Disable	Enables or Disables this function
Enable Hibernation	Control hibernation	Enable/ Disable	Enables or Disables this function

4.2.2.2 F81866 Super IO Configuration

You can use the screen to select options for Super IO Configuration, and change the value of the option selected. A description of the selected item appears on the right side of the screen.

For items marked with ►, please press <Enter> for more options.

Serial Port 1~5

Use these items to set parameters related to serial port 1~5.

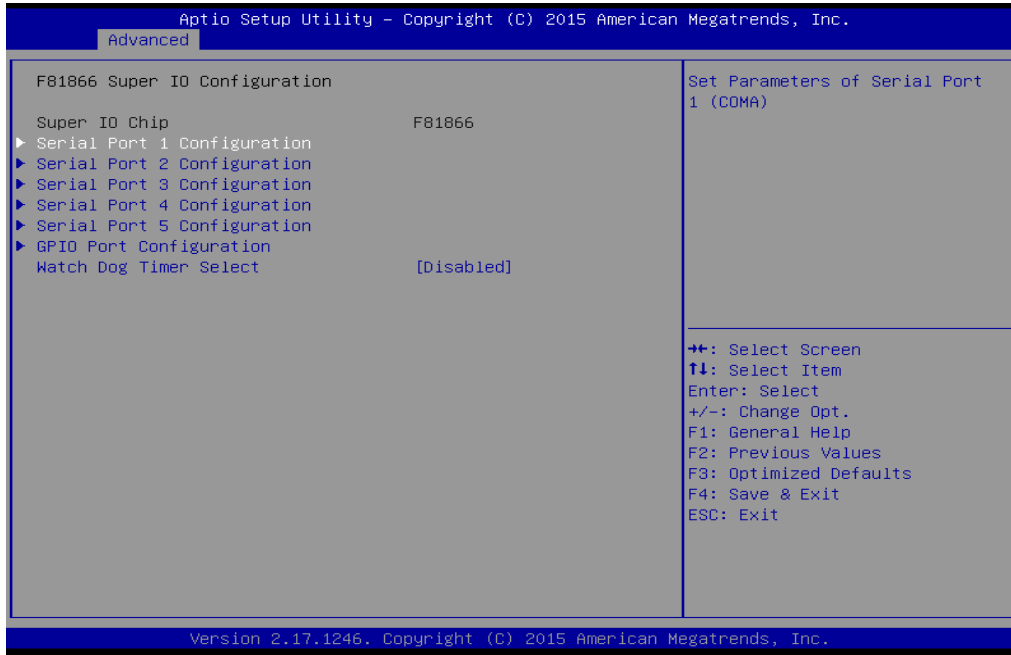

Watch Dog Time Select

You can either disable **Watch Dog Time Select**, or set up the time. Use <Arrow> keys to navigate and please press <Enter> to select the item.

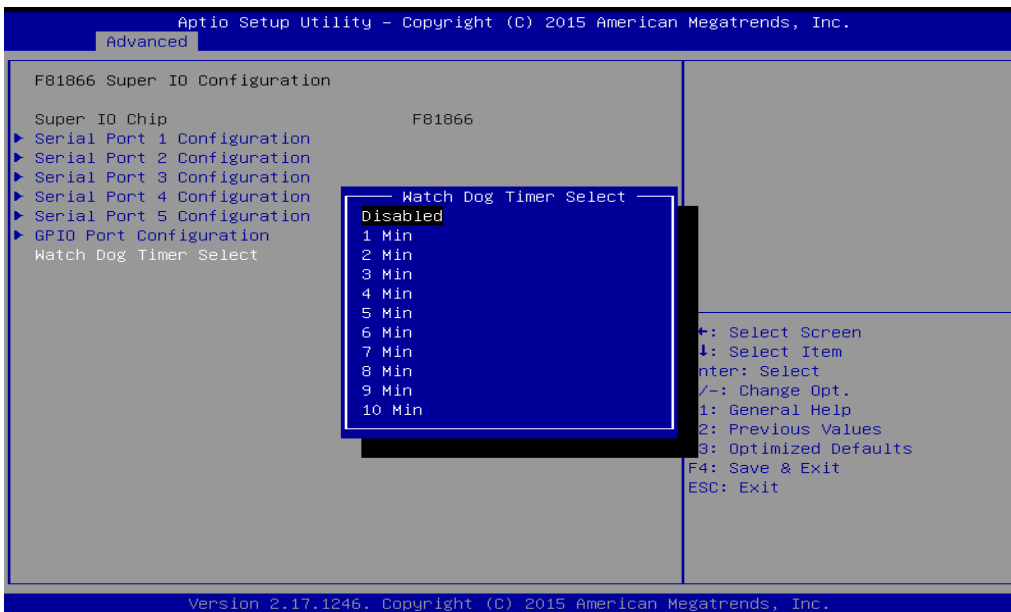

GPIO Port Configuration

You can use the screen to change GPIO Port setting. Use these items to set parameters related to **PIN3-PIN14 Control**.

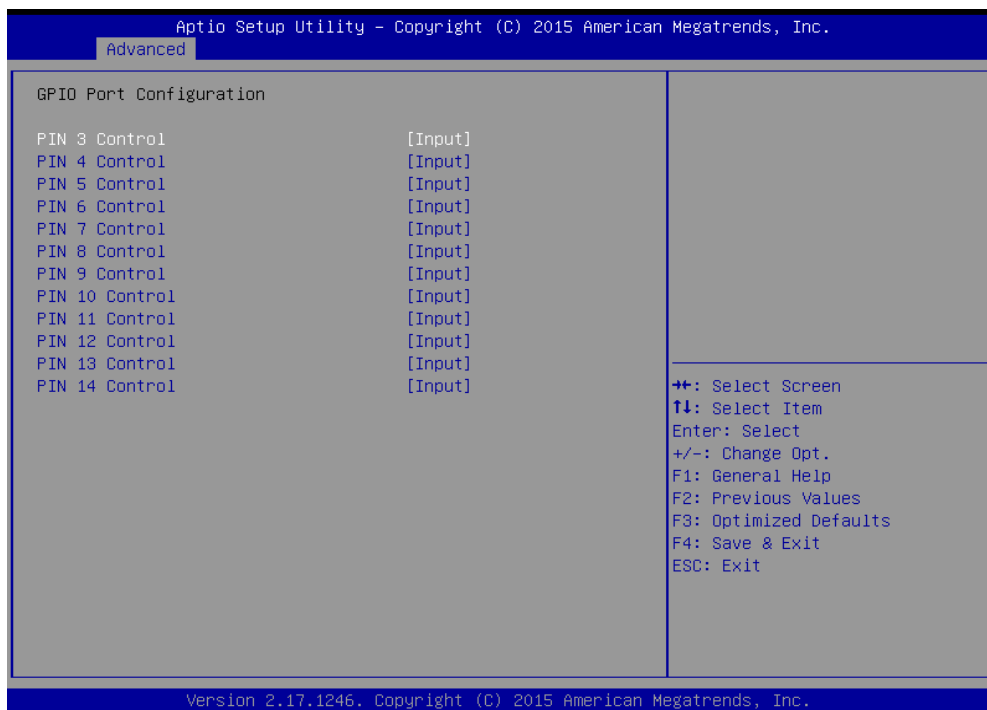

4.2.2.3 Hardware Monitor

You can check PC Health Status parameters such as system temperature, fan speed etc.

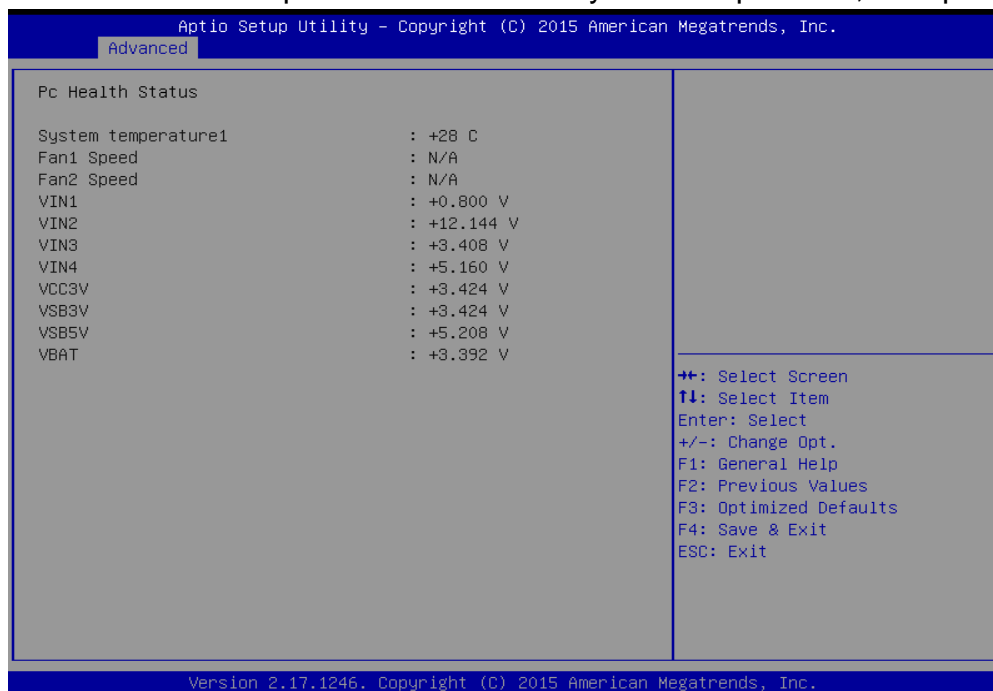

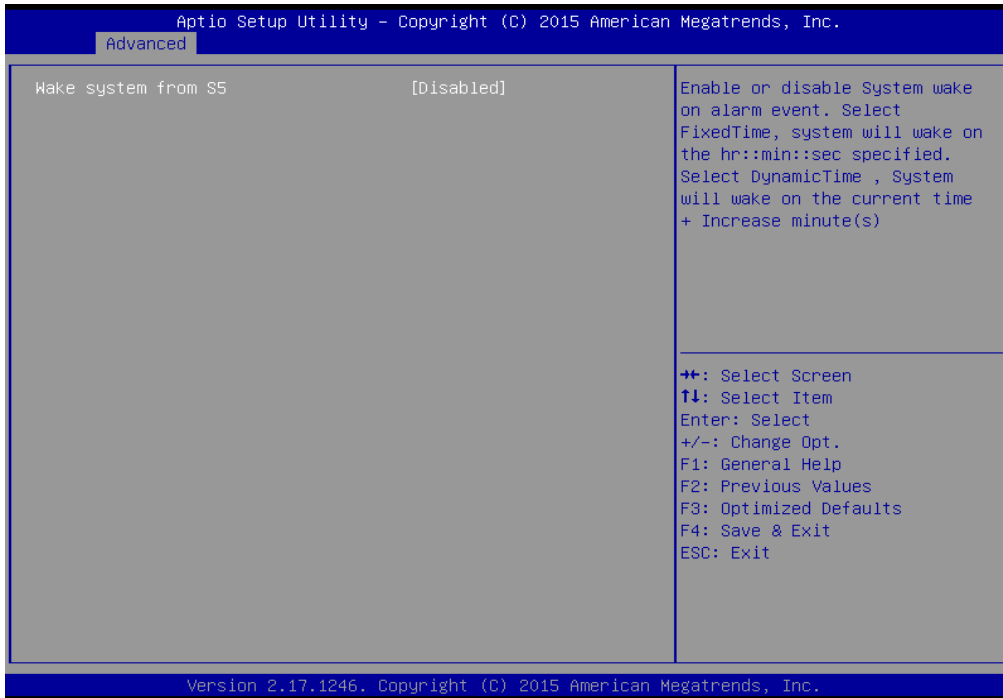

4.2.2.4 S5 RTC Wake Settings

Wake system from S5 enables or disables system wake on alarm event. It allows you to wake up the system in a certain time.



Wake System from S5 with fixed time setting

Select **Fixed Time** to set the system to wake on the specified time.

Use Navigation Keys   to switch among the items: Day, Hour, Minute and Second. Type the desired value in the selected item.

For example: If you want the system to start up automatically at 15:30:30, the 10th day of each month, then you should enter 10, 15, 30, and 30 from top to bottom.

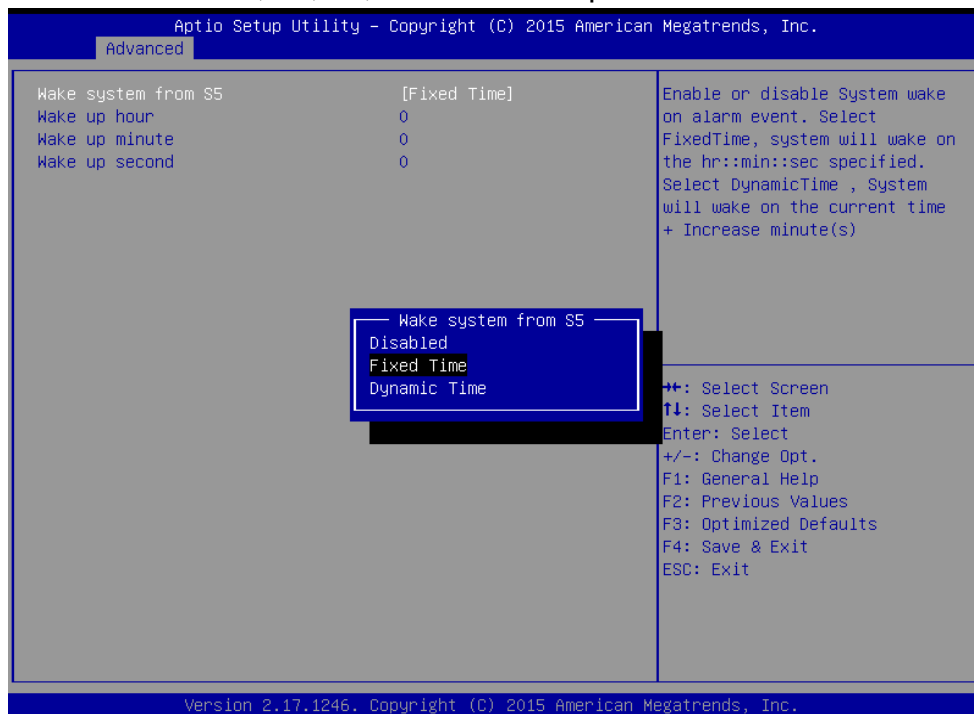

Wake system from S5 after dynamic time setting

Select **Dynamic Time** to set the system to wake on the current time + increase minute (s).

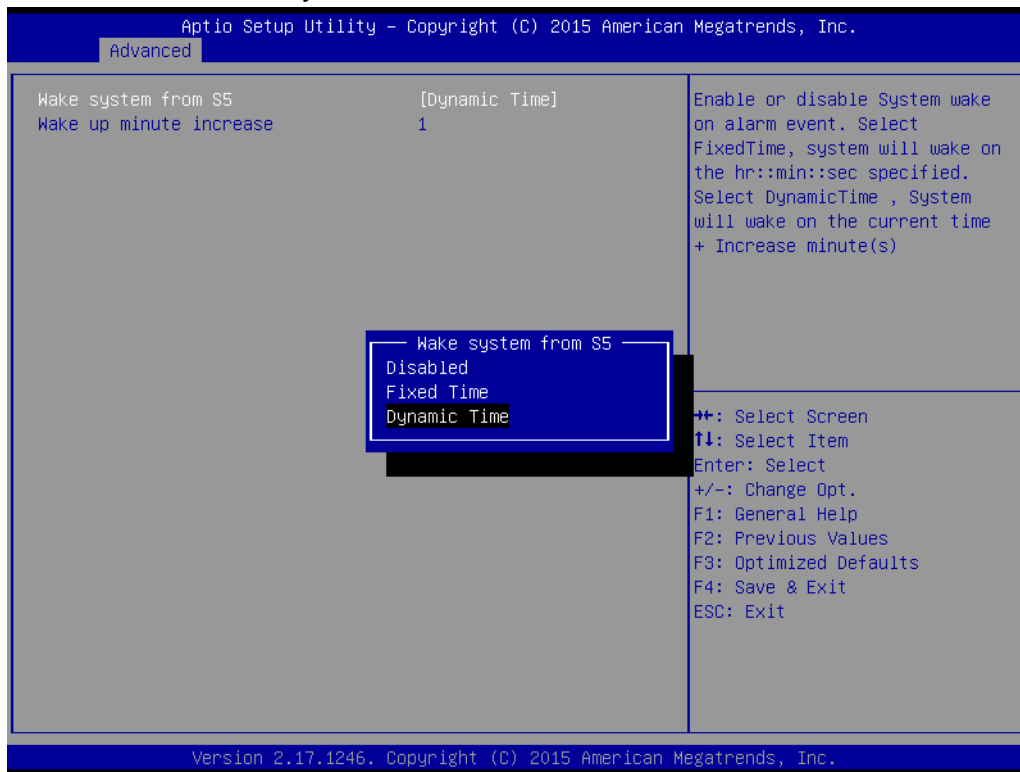

4.2.2.5 CPU Configuration

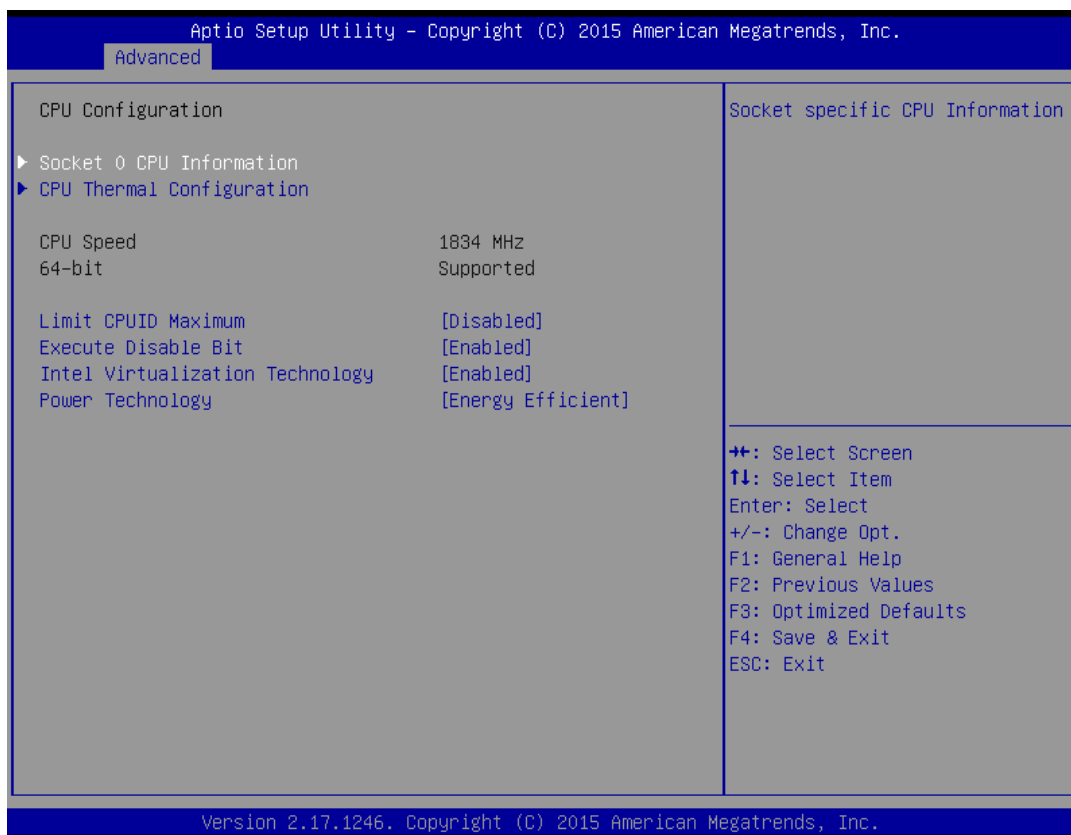

BIOS Setting	Description	Setting Option	Effect
Socket CPU Information	This item contains socket specific CPU information.	Enter	Open sub-menu
CPU Thermal Configuration	Thermal control	Enter	Open sub-menu
Limit CPUID Maximum	Limits CPIID Maximum	Disabled/Enabled	Enable/Disable this function
Execute Disable Bit	Execute Disable Bit	Disabled/Enabled	Enable/Disable this function
Intel Virtualization Technology	Allows to run recent OS and applications	Enabled/Disabled	Enable/Disable this function
Power Technology	Control the performance and power management.	Disabled	Disable this function
		Energy Efficient	Enable energy efficient mode

4.2.2.6 PPM Configuration



BIOS Setting	Description	Setting Option	Effect
CPU C State Report	Shows CPU C State Report	Enabled/ Disabled	Enable or Disable CPU C state report to OS
Max CPU C-State	Allows to enter power-saving mode in order to save energy	C1, C3, C6, C7, Auto	Enable or Disable CPU C Max CPU S-Sate

4.2.2.7 Thermal Configuration

This menu allows controlling thermal settings of the computer. Refer to the descriptions on the top right side of the screen for detailed information about each setting.



BIOS Setting	Description	Setting Option	Effect
Critical Trip Point	Specifies the temperature at which the OS will shut down the system	90C, 87C, 85C, 79C, 71C, 63C,55C,47C, 39C, 31C, 23C, 15C	Select the disable temperature for the system to shut down
Passive Trip Point	Specifies the temperature at which the OS will begin adjusting the processor	90C, 87C, 85C, 79C, 71C, 63C,55C,47C, 39C, 31C, 23C, 15C	Select the disable temperature for the system to start adjusting the processor

4.2.2.8 IDE Configuration

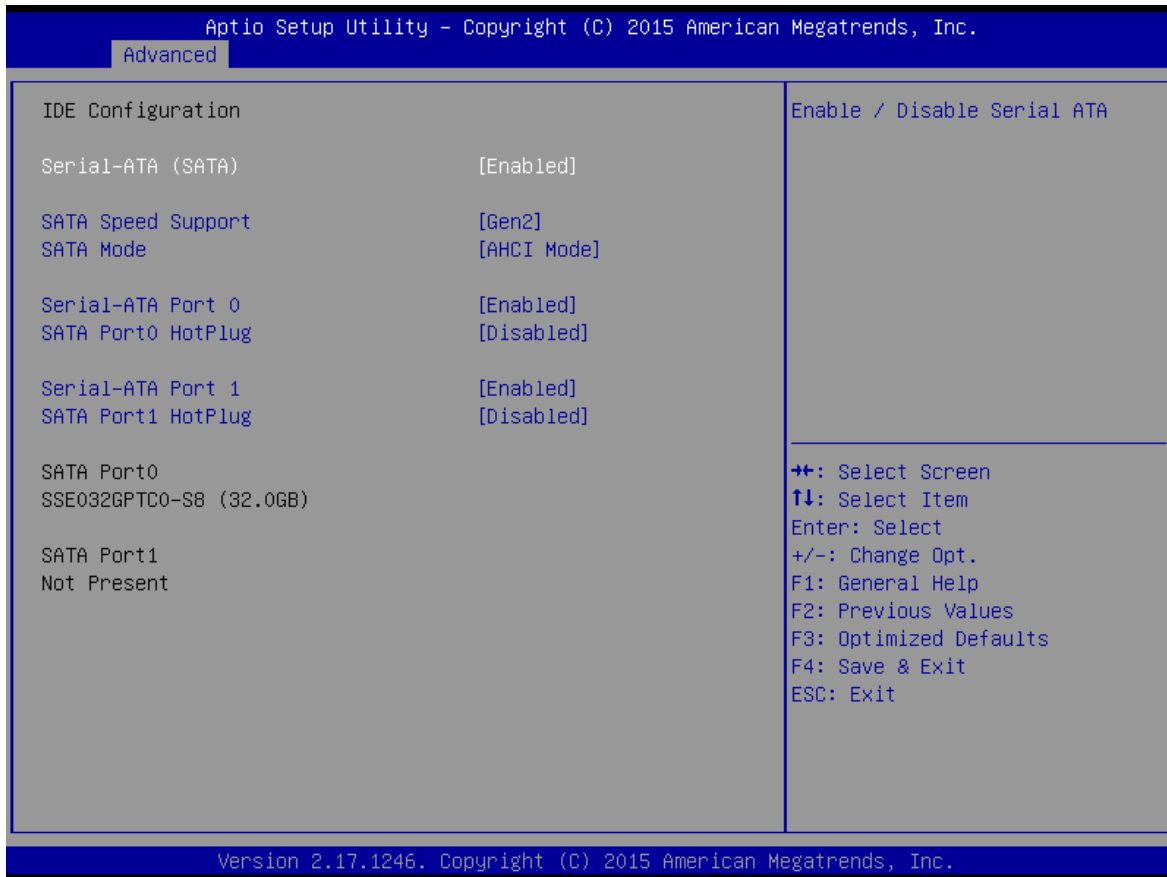

BIOS Setting	Description	Setting Option	Effect
Serial- ATA (SATA)	Responsible for supporting chipset drives with SATA interface.	Enabled/ Disabled	Enable or disable this function
SATA Speed Support	Allows forcing the speed limit SATA II ports standard IDE / SATA-controller chipset.	Gen1	The maximum speed will be limited to 150 MB/s
		Gen2	The maximum speed will be limited to 300 MB/s
		Disabled	Disables manual configuration of SATA II ports (mode will be selected based on the specifications of connected drives)
SATA Mode	This option specifies the operation mode of modern IDE / SATA-	[AHCI]	Selecting this option allows you to take full advantage of the extended host

BIOS Setting	Description	Setting Option	Effect
	controller chipset		controller SATA II
		[IDE]	SATA controller will operate in a mechanism similar to a conventional IDE-controller
		[RAID]	Allows combining hard drives in RAID-arrays in order to improve the reliability of data storage, or to increase the speed.
Serial- ATA Port 0	The option turns on or off Port 0 of SATA channels of standard IDE / SATA-controller chipset.	Enabled/ Disabled	Turn on (Enabled) or turn off (Disabled) Port 0
SATA Port0 HotPlug	This feature that allows you to attach and remove a SATA Port0	Enabled/ Disabled	Enable or disable this function
Serial- ATA Port 1	The option turns on or off Port 1 of SATA channels of standard IDE / SATA-controller chipset.	Enabled/ Disabled	Turn on (Enabled) or turn off (Disabled) Port 1
SATA Port1 HotPlug	This feature that allows you to attach and remove a SATA Port1	Enabled/ Disabled	Enable or disable this function

4.2.2.9 Miscellaneous Configuration

OS Selection

This item allows users to select the proper Operating System.

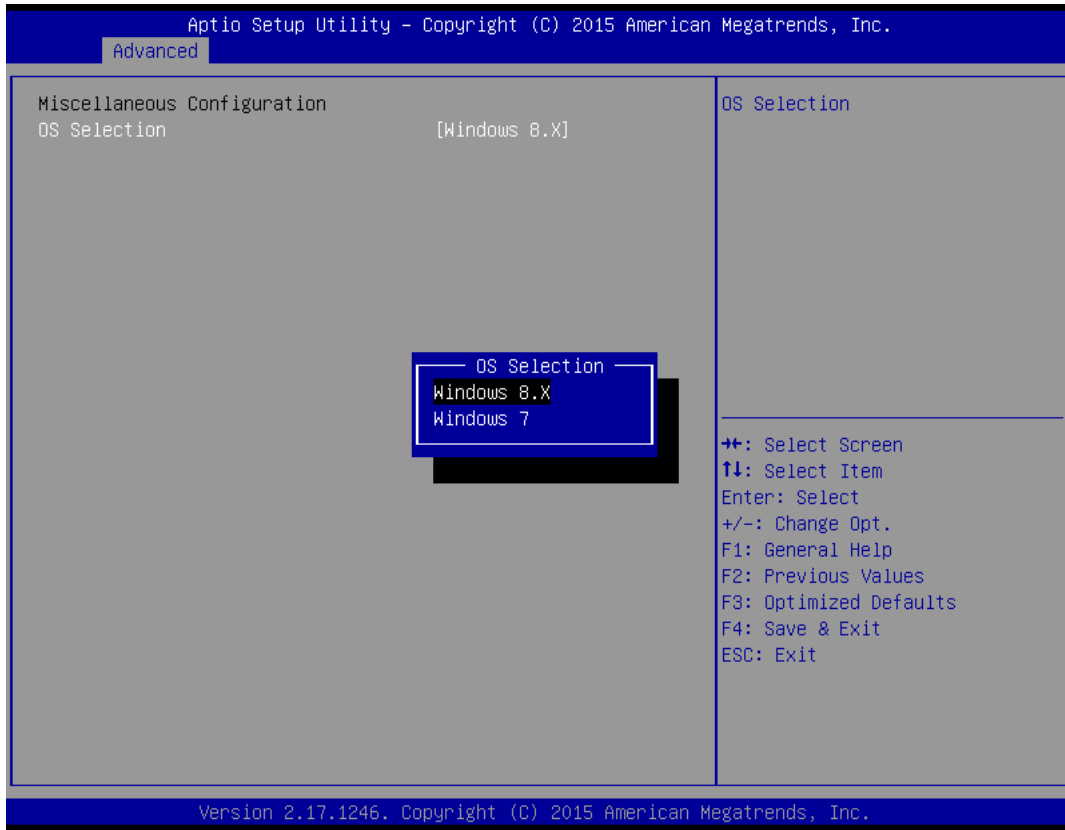

BIOS Setting	Description	Setting Option	Effect
Windows 8.X	Allows user to choose the proper OS.	Enter	Use Windows 8.X
Windows 7	Allows user to choose the proper OS.	Enter	Use Windows 7



IMPORTANT:

The device will be shipped with OS according to your order. BIOS OS Selection menu varies accordingly.

4.2.2.10 CSM Configuration

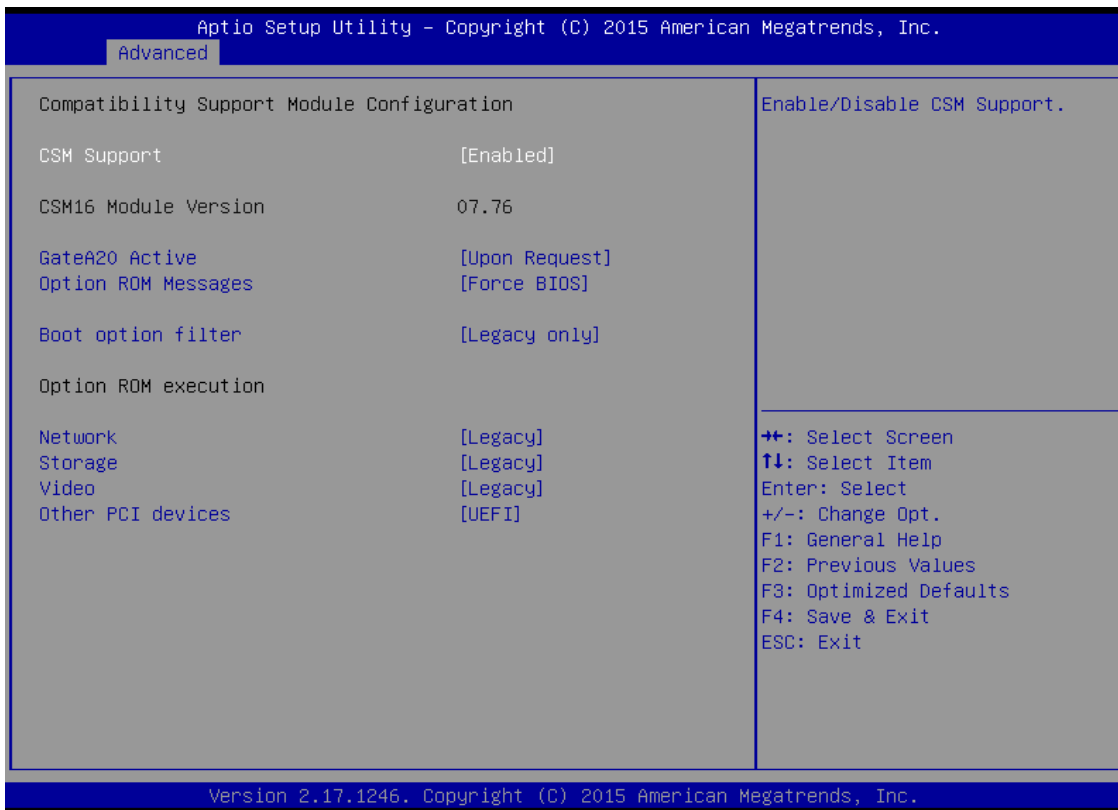

BIOS Setting	Description	Setting Option	Effect
CSM Support	The Compatibility Support Module (CSM) is a component of the UEFI firmware that provides legacy BIOS compatibility by emulating a BIOS environment, allowing legacy operating systems and some option ROMs that do not support UEFI to still be used.	Enabled/ Disabled	Enable or disable the Compatibility Support Module
GetaA20 Active	Activate GetaA20	Upon Request	Enable or disable this function
Option ROM Messages	Receiving ROM Messages Settings	Force BIOS	Set ROM messages parameters

BIOS Setting	Description	Setting Option	Effect
Network	Specifies which Network option ROM is booted	UEFI	Only UEFI option ROMs are booted
		Legacy	
Storage	Specifies which Storage option ROM is booted	UEFI	Only UEFI option ROMs are booted
		Legacy	Only Legacy option ROMs are booted
Video	Specifies which Video option ROM is booted	UEFI	Only UEFI option ROMs are booted
		Legacy	Only Legacy option ROMs are booted
Other PCI Devices	Specifies which option ROM is booted for devices other than the network, storage or video	UEFI	Only UEFI option ROMs are booted
		Legacy	Only Legacy option ROMs are booted

4.2.2.11 USB Configuration

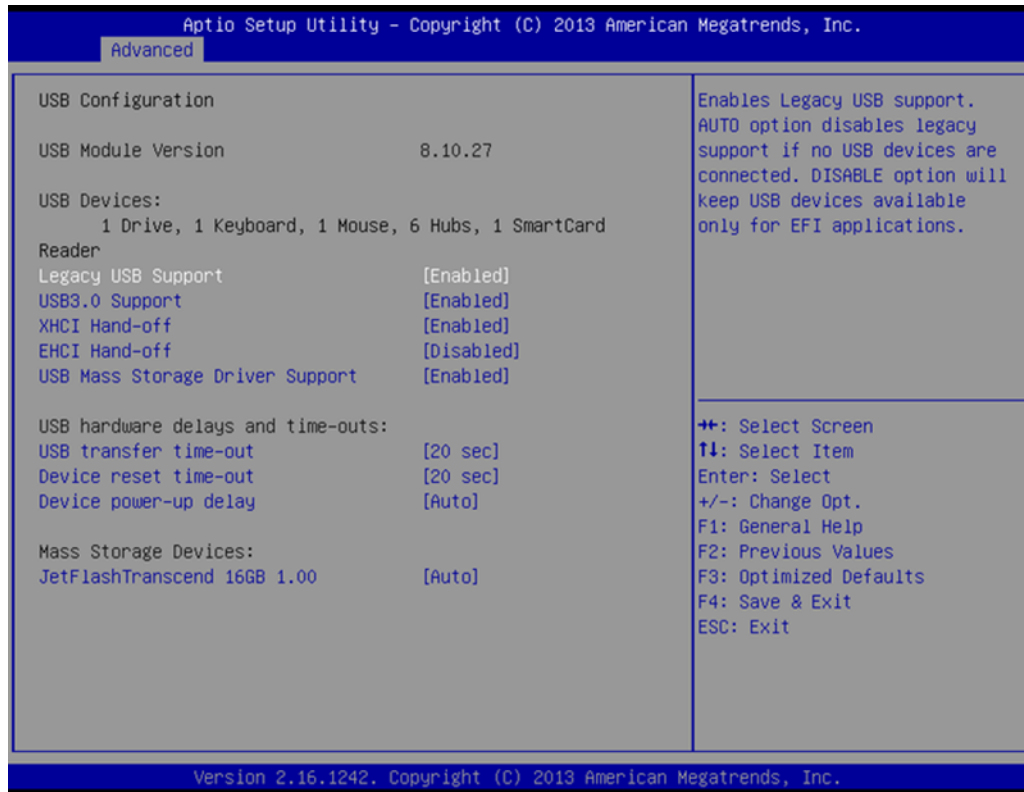

BIOS Setting	Description	Setting Option	Effect
Legacy USB Support	User can enable or disable USB port.	Disable	Will keep USB devices available only for EFI applications.
		Enable	Enable all the USB devices
USB 3.0 Support	User can enable or disable USB 3.0 (XHCI) controller support.	Enable	Enable USB 3.0 is enable
		Disable	USB 3.0 is disable
XHCI Hand-off	This is a workaround for OSs without XHCI hand- off support.	Disable	Disables this function
		Enable	Enables this function
EHCI Hand-off	This is a workaround for OSs without ECHI hand- off support.	Disable	Disables this function
		Enable	Enables this function
USB mass storage driver	User can Enable or disable USB mass	Disable	Disables this function
		Enable	Enables this function

BIOS Setting	Description	Setting Option	Effect
support	storage driver support.		
USB Transfer time- out	The time-out value for control, bulk, and interrupt transfers.	1 Sec 5 Sec 10 Sec 20 Sec	Depends on the time-out value
Device Reset time- out	USB mass storage device start unit command time- out.	10 Sec 20 Sec 30 Sec 40 Sec	Depends on the time-out value
Device power-up delay	Maximum time the device will take before it properly reports itself to the host controller.	Auto	Uses default value: for a root port it is 100 ms, for a Hub port the delay is taken from Hub descriptor

4.2.2.12 Security Configuration

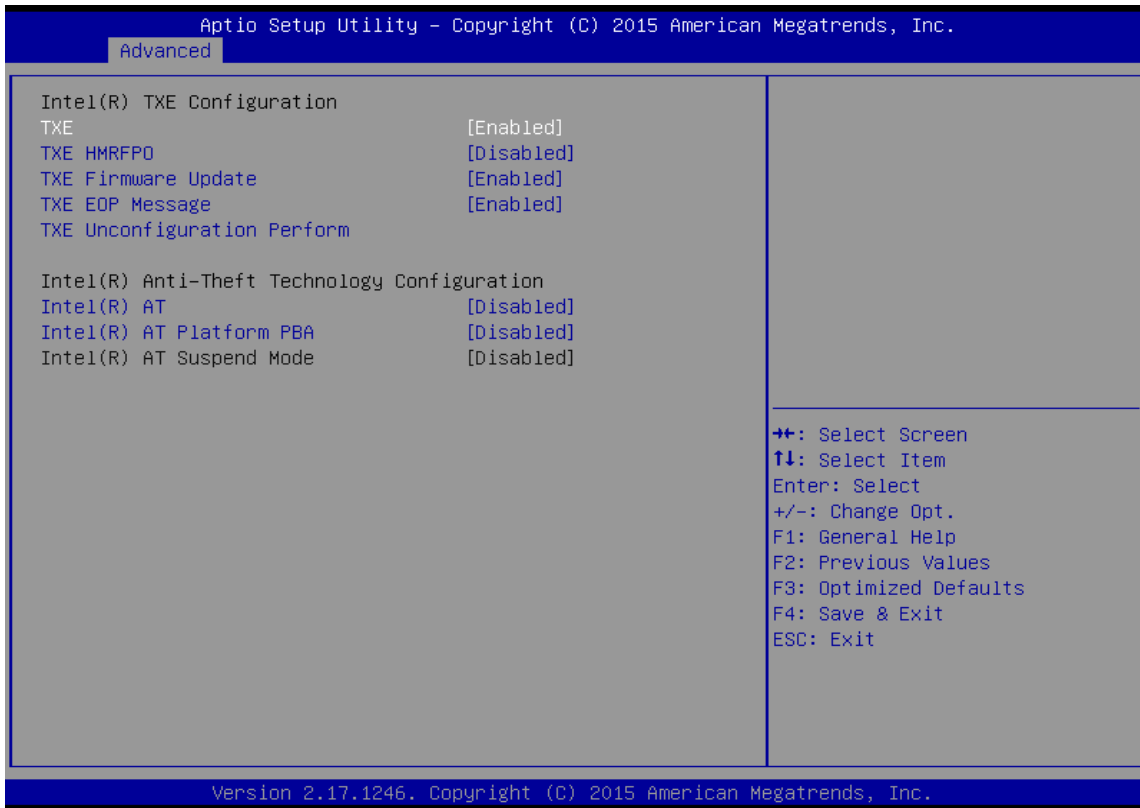

BIOS Setting	Description	Setting Option	Effect
TXE	Trusted Execution Technology parameters	Enabled/Disabled	Enables or disables this function
TXE HMRFPD	TXE HMRFPD parameters	Enabled/Disabled	Enables or disables this function
TXE Firmware Update	TXE Firmware Update parameters	Enabled/Disabled	Enables or disables this function
TXE EOP Message	TXE EOP Message parameters	Enabled/Disabled	Enables or disables this function
Intel® AT	Intel® AT parameters	Enabled/Disabled	Enables or disables this function
Intel® AT Platform PBA	Intel® AT Platform PBA parameters	Enabled/Disabled	Enables or disables this function

4.2.3 Chipset Menu

For items marked with ►, please press <Enter> for more options.

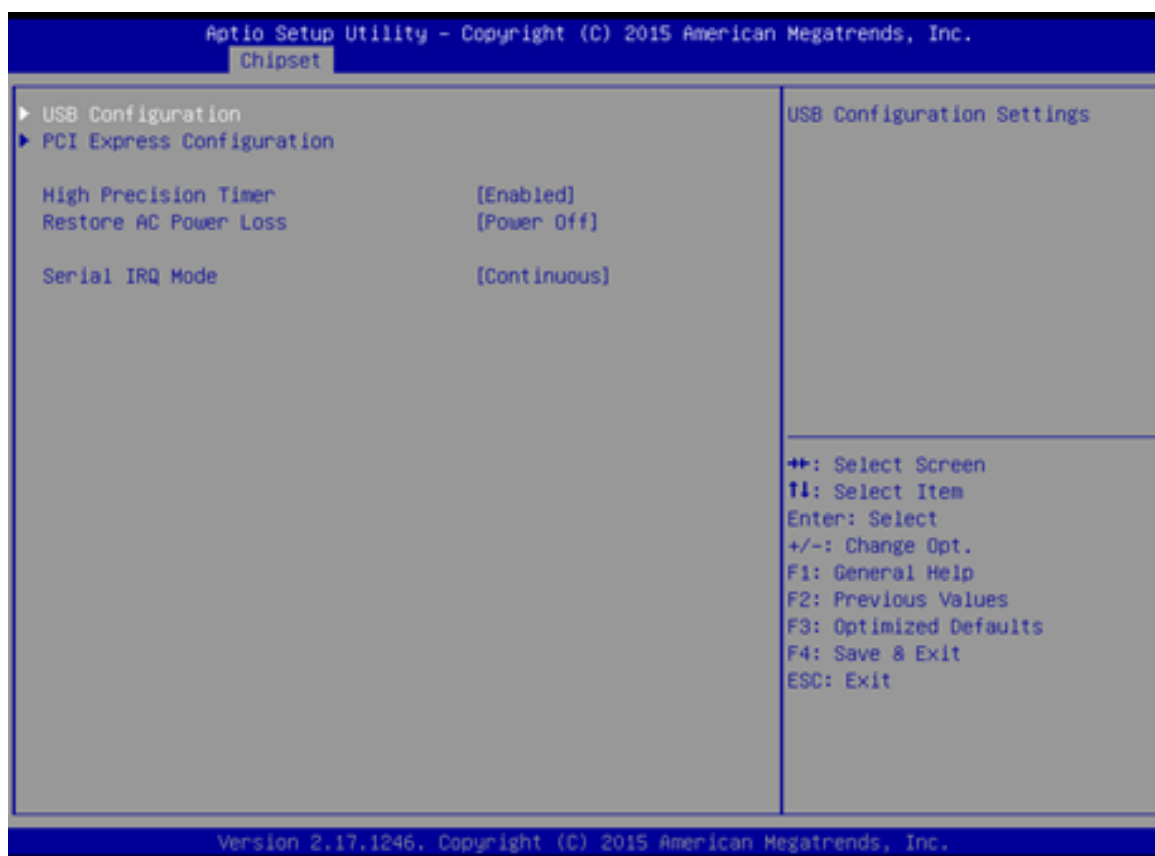

BIOS Setting	Description	Setting Option	Effect
High Precious Timer	Allow to set up High Precious Timer settings	Enabled/ Disabled	Enables/Disables this function
Restore AC Power Loss	This function allows to set up booting options after a power failure	Power on/ Power off	Boot automatically after a power failure
Serial IRQ Mode	When working with personal computer hardware, installing and removing devices, the system relies on interrupt requests. Interrupt request	Continuous	Allow user to set up desired IRQ Mode

4.2.4 Security Menu

In the Security menu, users can set administrator password, user password, and HDD security configuration.

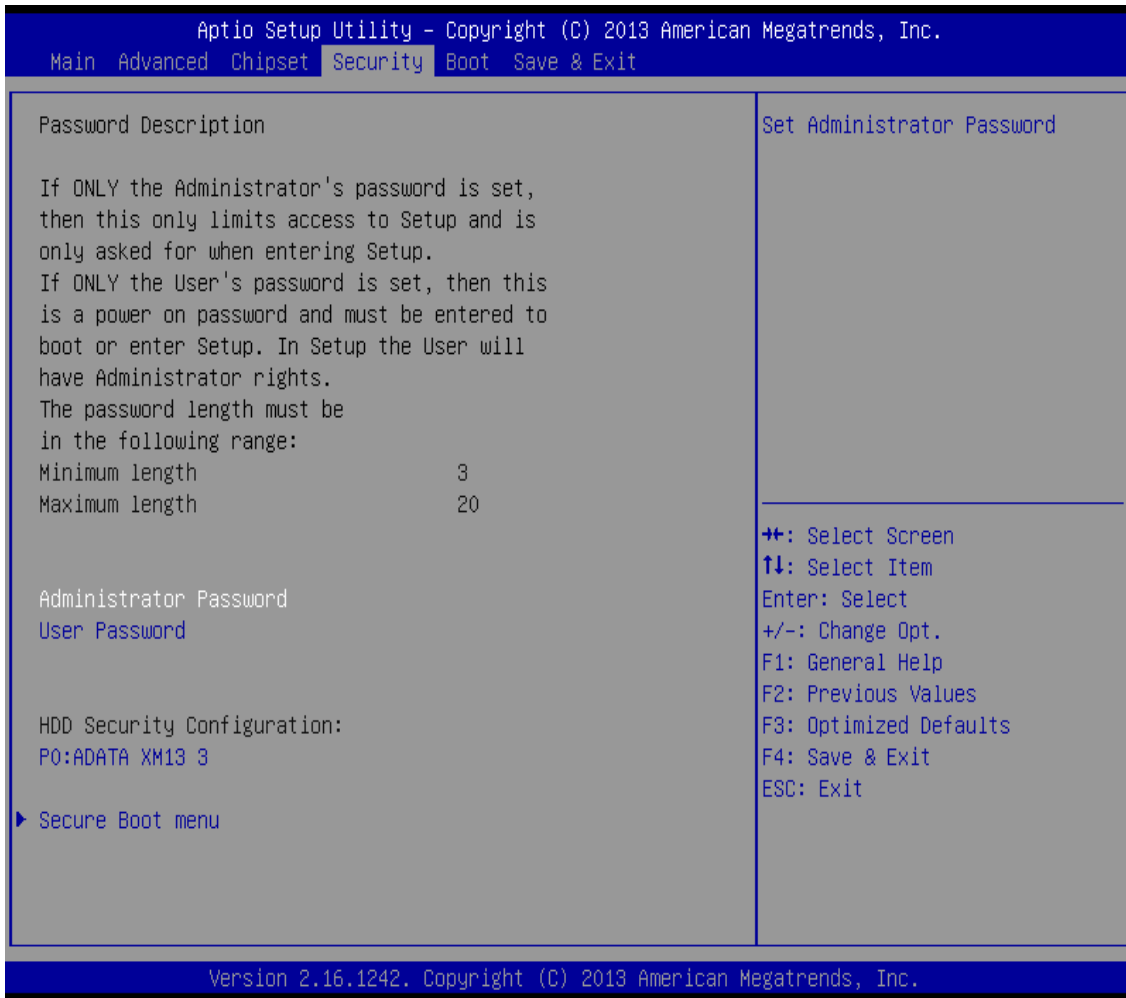

BIOS Setting	Description	Setting Option	Effect
Administrator Password	Displays whether or not an administrator password has been set.	Enter	Enter password
User Password	Display whether or not a user Password has been set.	Enter	Enter password

4.2.5 Boot Configuration

The Boot menu sets the sequence of the devices to be searched for the operating system. The bootable devices will be automatically detected during POST and shown here, allowing you to set the sequence that the BIOS uses to look for a boot device from which to load the operating system.

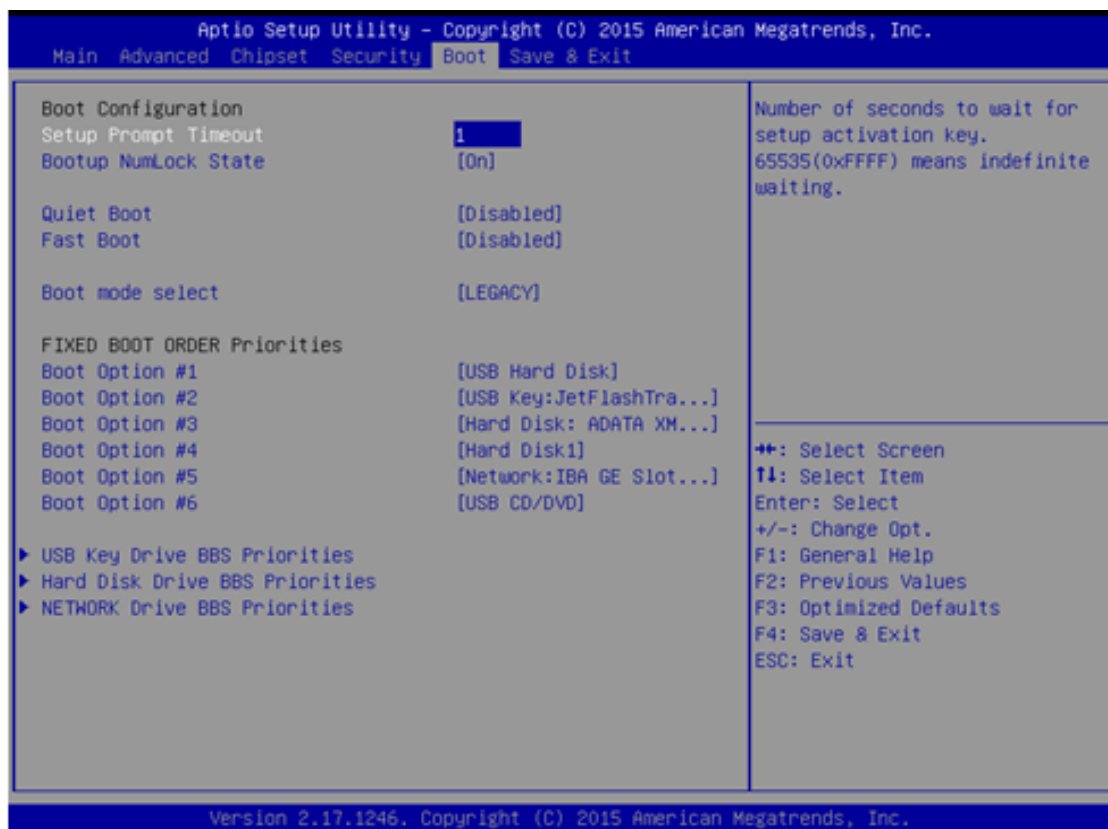

BIOS Setting	Description	Setting Option	Effect
Setup Prompt Timeout	Allows user to configure the number of seconds to stay in BIOS setup prompt screen.	Enter	Set the prompt timeout
Boot NumLock State	Enables or disables NumLock feature on the numeric keypad of the keyboard after the POST (Default: On).	On	Remains On
		Off	Remains OFF
Quiet Boot	Determines if POST message or OEM logo (default = Black background) is displayed.	Disabled	Disables this function
		Enabled	Enables this function
Fast Boot	Enables or disables Fast Boot to shorten the OS boot process. (Default: Disabled).	Disabled	Disables this function
		Enabled	Enables this function

BIOS Setting	Description	Setting Option	Effect
Boot Mode Select	Specifies which mode will be used for booting	Legacy	Only Legacy option is booted
		UEFI	Only UEFI option is booted
Boot Option #1~#6	Specifies the overall boot order from the available devices	Ex: Boot Option#1 (hard drive)	Hard drive as the first priority
USB Key Drive BBS Priorities	USB Key Drive BBS Priorities	Enter	Open sub-menu
Hard Disk Drive BBS Priorities	Hard Disk Drive BBS Priorities	Enter	Open sub-menu
Network Drive BBS Priorities	Network Drive BBS Priorities	Enter	Open sub-menu

4.2.6 Save & Exit

The Exit menu displays a way how to exit BIOS Setup utility. After finishing your settings, you must save and exit for changes to be applied.



BIOS Setting	Description	Setting Option	Effect
Save Changes and Exit	This saves the changes to the CMOS and exits the BIOS Setup program.	Enter <YES>	Save changes
Discard Changes and Exit	This exits the BIOS Setup without saving the changes made in BIOS Setup to the CMOS.	Enter <YES>	Saves the changes
		Enter <NO>	Return to the BIOS Setup Main Menu

BIOS Setting	Description	Setting Option	Effect
Save Changes and Reset	Reset the system after saving the changes.	Enter <YES>	Saves the changes
		Enter <NO>	Return to the BIOS Setup Main Menu
Discard Changes and Reset	Reset system setup without saving any changes	Enter <YES>	Saves the changes
		Enter <NO>	Return to the BIOS Setup Main Menu
Save Changes	Save changes done so far to any of the setup options.	Enter <YES>	Saves the changes
		Enter <NO>	Return to the BIOS Setup Main Menu
Discard Changes	Discard changes done so far to any of the setup options.	Enter <YES>	Saves the changes
		Enter <NO>	Return to the BIOS Setup Main Menu
Restore Default	Restore/load default values for all the setup options.	Enter <YES>	Saves the changes
		Enter <NO>	Return to the BIOS Setup Main Menu
Save as User Defaults	Save the changes done so far as User defaults.	Enter <YES>	Saves the changes
		Enter <NO>	Return to the BIOS Setup Main Menu
Restore User Defaults	Restore the User Defaults to all the setup options.	Enter <YES>	Saves the changes
		Enter <NO>	Return to the BIOS Setup Main Menu

4.3 Using Recovery Wizard to Restore Computer

The Panel PC has a dedicated recovery partition stored on the hard drive of the PC to enable quick one-key recovery process. This partition occupies about 11GB of the storage space, and comes built-in to the PC.

**NOTE:**

Before starting the recovery process, make sure to backup all user data. The data will be lost after the recovery process.

To enable quick one-key recovery procedure:

- Plug-in the AC adapter to Bay Trail series computer. Make sure the computer stays plugged in to power source during the recovery process.
- Turn on the computer, and when the boot screen shows up, press the **F6** to initiate the Recovery Wizard.
- The following screen shows the Recovery Wizard. Click **Recovery** button to continue.



A warning message about data loss will show up. Make sure the data is backed up before recovery, and click **Yes** to continue.



Wait the recovery process to complete. During the recovery process, a command prompt will show up to indicate the percent of recovery process complete. The system will restart automatically after recovery completed.

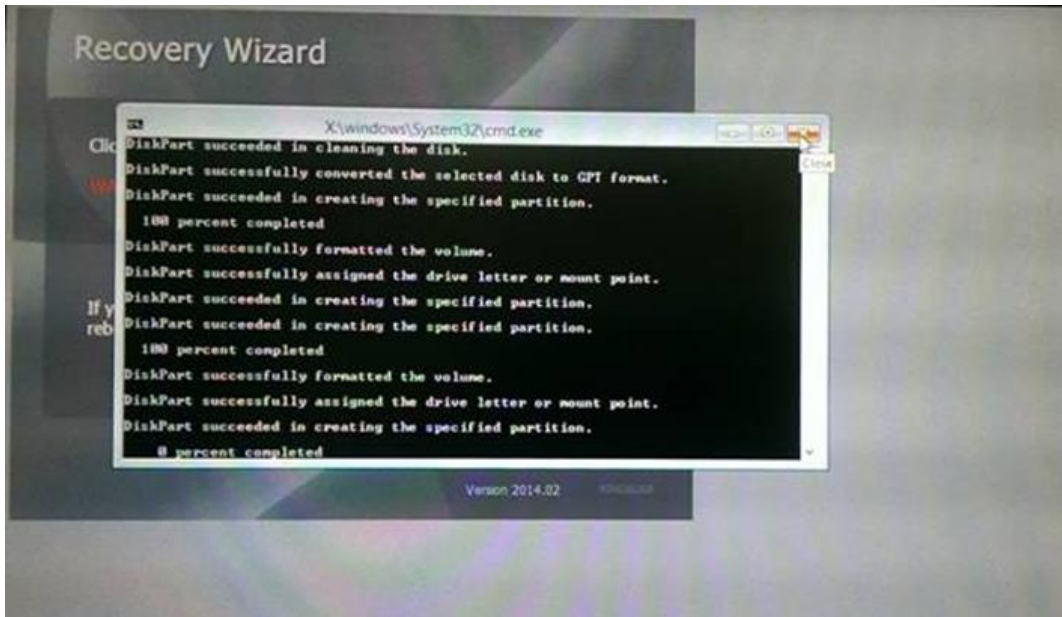

Chapter 5: Driver Installation

This chapter provides guideline to driver installations.

5.1 Installing Chipset Driver

Step 1 Insert the CD that comes with the motherboard. Open the file document “Chipset Driver” and click “infinst_auto.exe” to install driver.

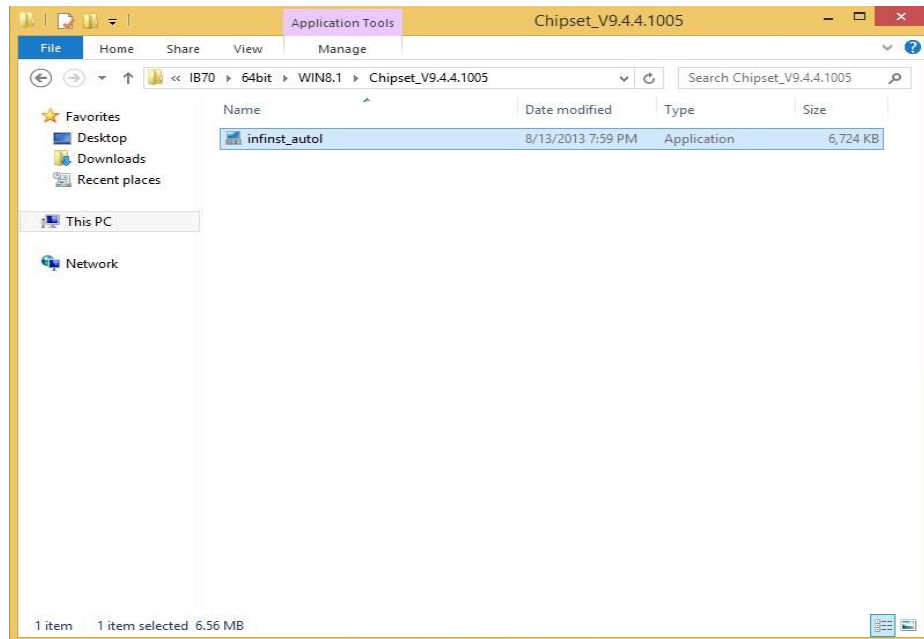

Step 2 Click **Next** to continue.



Step 3 Click **Yes** to agree the license terms.



Step 4 Click **Next** to install the driver.



Step 5 Software setup progress window will appear, click **Next** to continue.

Step 6 Click "Yes, I want to restart this computer now" to finish the installation.

5.2 Installing Graphics Driver

Step 1 Insert the CD that comes with the motherboard. Open the file document “**Graphics Driver**” and click **Setup** to execute the setup.

Step 2 Setup Welcome Window will appear, click **Next** to continue the process.

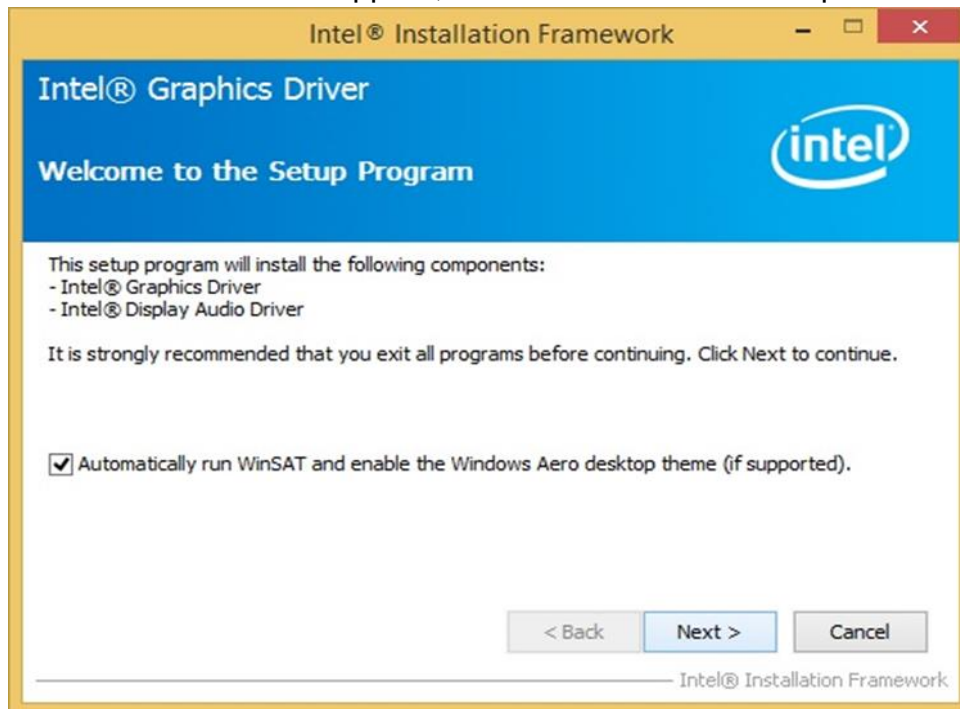

Step 3 Carefully read the license terms and click **Yes** to agree.

Step 4 Check Readme file information, and click **Next** to install driver.

Step 5 Click **Next** to continue.

Step 6 Windows Security window will appear, click “**Install this driver software anyway**” to continue.

Step 7 Setup Progress window will appear, click **Next** to continue the installation.

Step 8 Setup is complete, click “**Yes, I want to restart this computer now**” to finish the installation and restart the computer.

5.3 Installing Intel Sideband Fabric Device (Intel MBI)

Driver

Only for Windows 8.

Step 1 Insert the CD that comes with the motherboard. Open the file document “**MBI**” and click “**Setup.exe**” to install the driver.

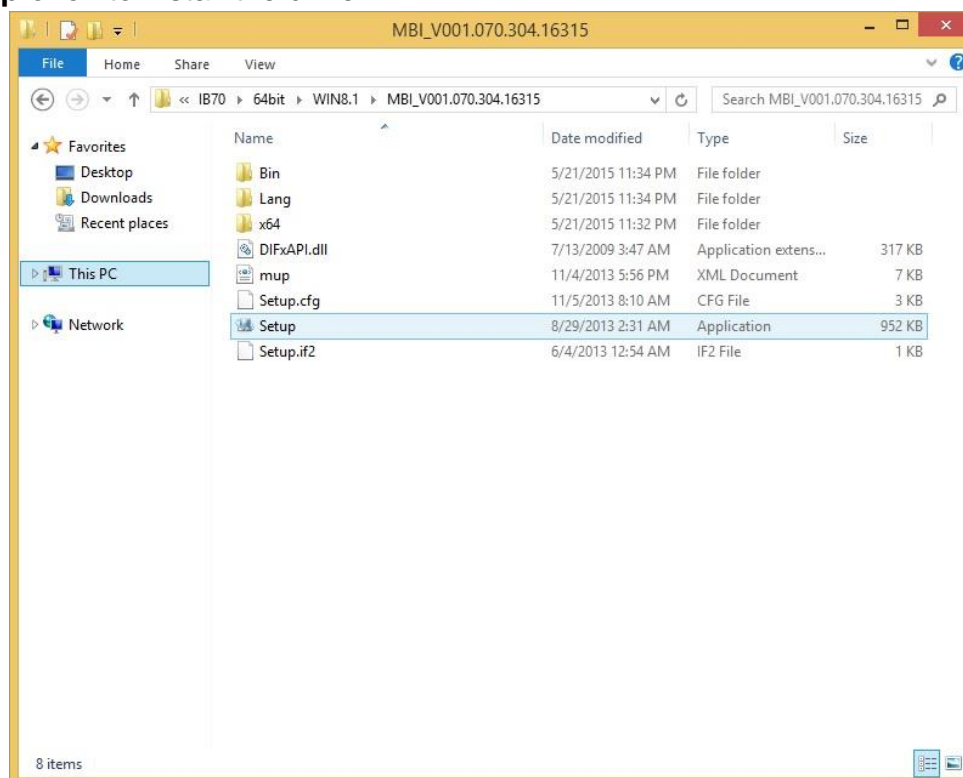

Step 2 Welcome to the setup program window will appear, click **Next** to start the installation.

Step 3 Carefully read the License Agreement terms and click **Yes** to agree.

Step 4 Setup progress will appear, please wait for the operations to be performed, then click **Next** to continue.

Step 5 The installation is complete, click “**Yes, I want to restart this computer now**” to finish and restart the computer.

5.4 Installing Intel Trusted Engine Interface (Intel TXE) Driver

Step 1 Insert the CD that comes with the motherboard. Open the file document “TXE” and click “Setup TXE.exe” to install the driver.

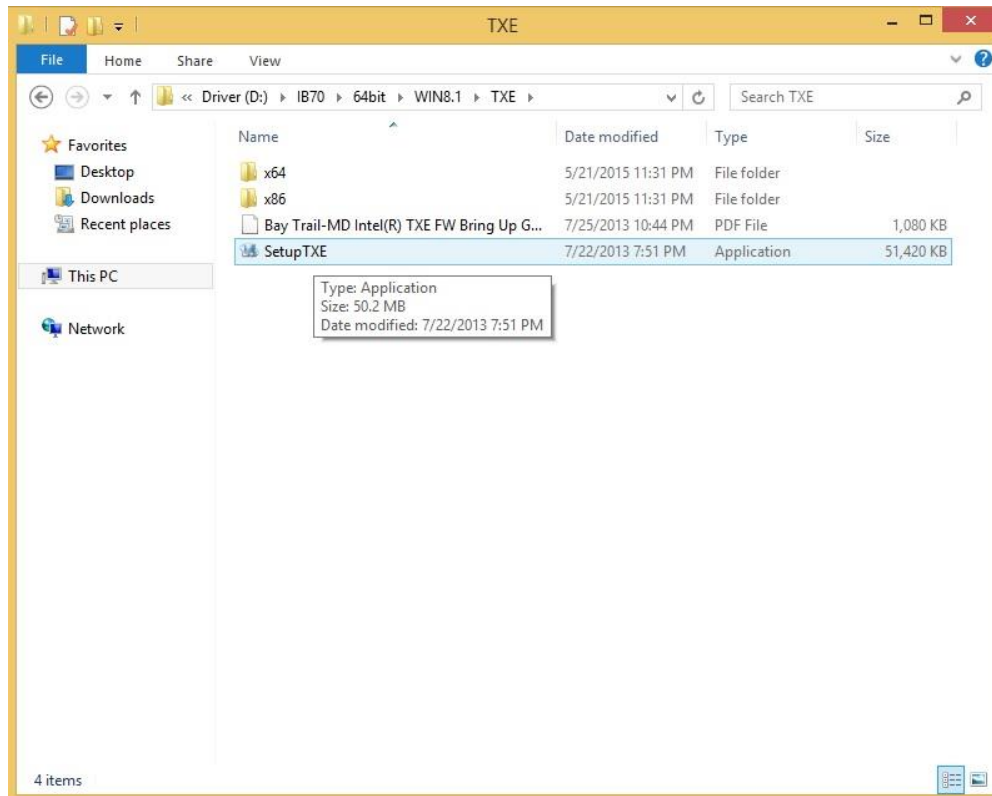

Step 2 Welcome to the setup program window will appear, click **Next** to start the installation.

Step 3 Carefully read the license terms and click **Yes** to agree.

Step 4 Confirmation window will appear, click **Next** to continue the driver installation.

Step 5 Please wait while the product is being installed.

Step 6 The installation is complete, click **Finish** to complete the installation and restart the computer.

5.5 Installing Intel Network Connections

User must confirm the type of operating system is being used before installing Intel Network Connections. Follow the steps below to complete the installation.

Step 1 Click “PROWin64.exe”

Step 2 Click **Yes** to start the installation.

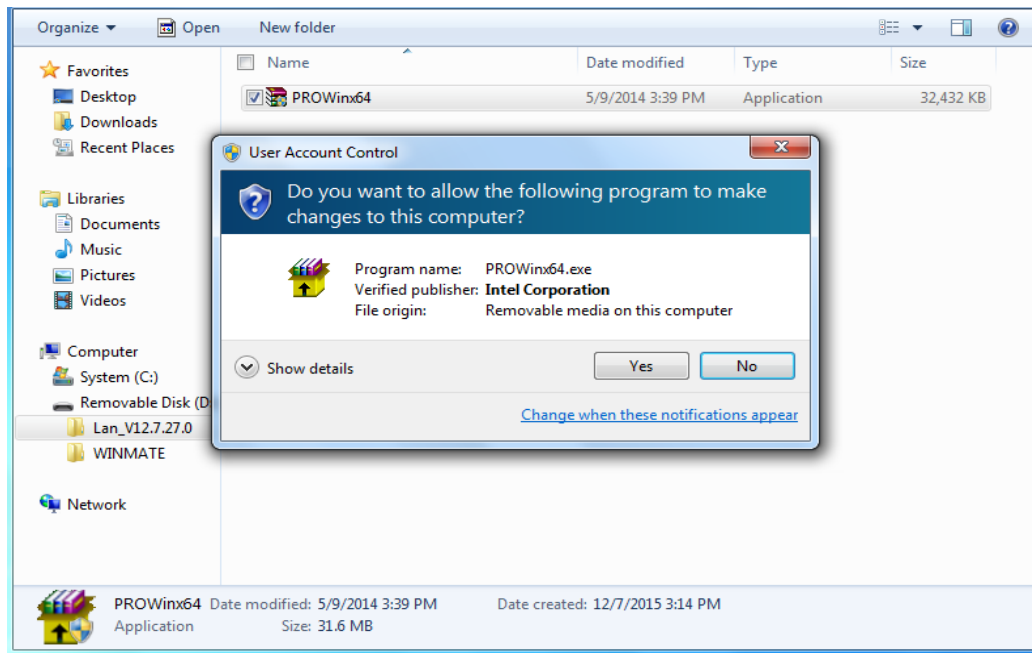

Step 3 Welcome window will appear, click **Next** to install the driver.

Step 4 In the program maintenance window you will see two options available. “Remove” is to remove Intel Networks Connections from your computer, and “Modify” is to make any changes. Choose **Modify** to continue.

Step 5 In the **Setup Options** window choose “**Intel® PRO Set for Windows® Device Manger**”, “**Intel ® Network Connections SNMP Agent**” and “**Advanced Network Services**”.

Step 6 The wizard is ready to begin installation, click **Install** to continue.

Step 7 Install wizard completed, click **Finish** to complete the installation.

5.6 Installing Audio Driver

The ALC886 series are high-performance 7.1+2 channel high definition audio codecs that provide ten DAC channels for simultaneous support of 7.1 sound playback, plus 2 channels of independent stereo sound output (multiple streaming) through the front panel stereo outputs. The series integrates two stereo ADCs that can support a stereo microphone, and feature Acoustic Echo Cancellation (AEC), Beam Forming (BF), and Noise Suppression (NS) technology.

Step 1 Insert the CD that comes with the motherboard. Open the file document “Audio Driver” and click “Setup.exe” to install the driver.

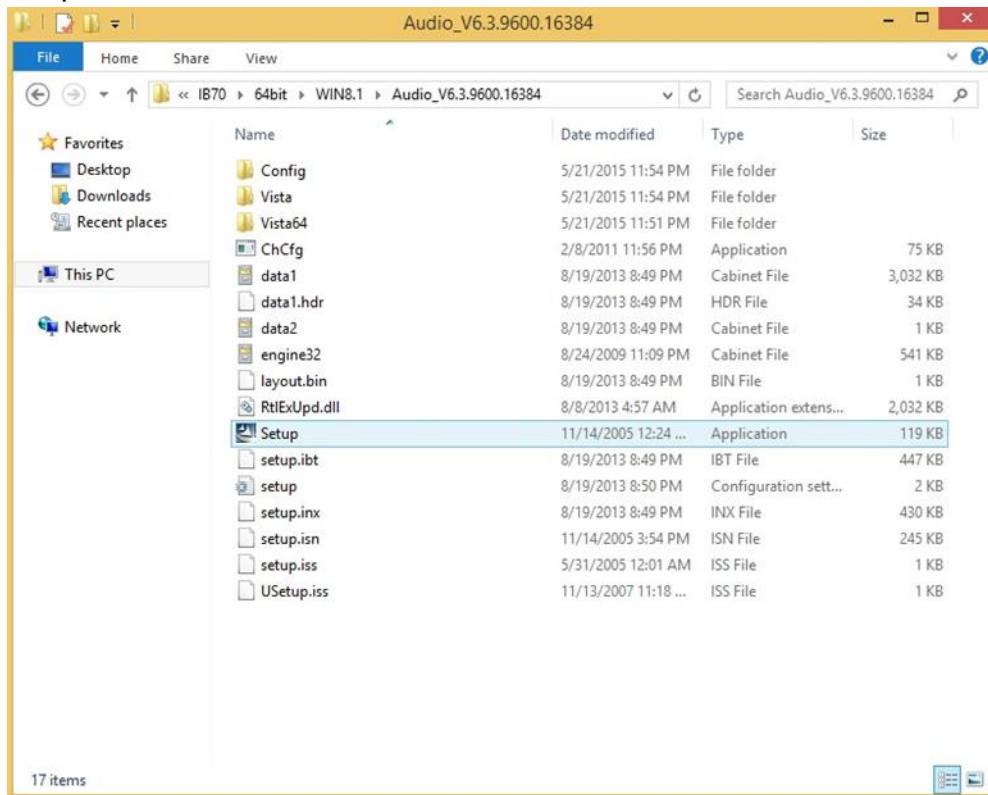

Step 2 Please wait while the InstalShield Wizard prepares the setup.

Step 3 Welcome window will appear, click **Next** to install the driver.

Step 4 It might take some time to configure new software installation. Please wait.

Step 5 Windows security will appear, click **Install** to install the audio driver.

Step 6 The installation is complete, select “**Yes, I want to restart my computer now**”, and click **Finish** to complete the installation.

Chapter 6: Mounting

This chapter provides mounting guide for all available mounting options. Pay attention to cautions and warning to avoid any damages.



WARNING! / AVERTISSEMENT!

Follow mounting instructions and use recommended mounting hardware to avoid the risk of injury.

Suivez les instructions de montage et d'utilisation recommandé le matériel de montage pour éviter le risque de blessure.

6.1 Cable Mounting Considerations

For a nice look and safe installation, make sure cables are neatly hidden behind the HMI device. Refer to [Chapter 2, section 2.1](#) for the cable installation instruction.



WARNING! / AVERTISSEMENT!

Observe all local installation requirements for connection cable type and protection level.

Suivre tous les règlements locaux d'installations, de câblage et niveaux de protection.



WARNING! / AVERTISSEMENT!

Turn off the device and disconnect other peripherals before installation.

Éteindre l'appareil et débrancher tous les périphériques avant l'installation.



ALTERNATING CURRENT / MISE À LE TERRE!

To prevent electrical shock, the Safety Ground location on the rear must be bonded to the local earth ground through a minimum 12 AWG wire as short as possible

Pour éviter les chocs électriques, l'emplacement de la prise terre à l'arrière doit être lié à terre locale, à travers un 12 AWG minimum et aussi court que possible.

6.2 Safety Precautions

Observe the following common safety precautions before installing any electronic device:

- Use separate, non-intersecting paths to route power and networking wires. If power wiring and device wiring paths must be crossed make sure the wires are perpendicular at the intersection point.
- Keep the wires separated according to the interface. Wires that share similar electrical

characteristics must be bundled together.

- Do not bundle input wiring with output wiring. Keep them separate.

When necessary, it is strongly advised that you label wiring to all devices in the system.

6.3 Mounting Guide

The IP69K Stainless P-CAP Panel PC comes with different mounting options suitable for most of the industrial applications. The main mounting approach is chassis - very user-friendly in terms of installation. Refer to sub-sections below for more details.

6.3.1 VESA Mount

Flat Stainless P-CAP Panel PC has VESA mount holes on the rear side. Follow instructions below to mount the unit with VESA Mount bracket (not supplied by Winmate).

Size	VESA Plate Dimensions	Screw hole diameter
10.4", 15", 19"	100 x 100 mm	VESA M4x5 mm
21.5"	100 x 200 mm	VESA M4x5 mm
23.8"	100 x 200 mm	VESA M6x8 mm

Mounting Instruction:

1. Screw VESA bracket to the fixture (ex. swing arm) with four VESA screws.
2. Place the device on VESA bracket.

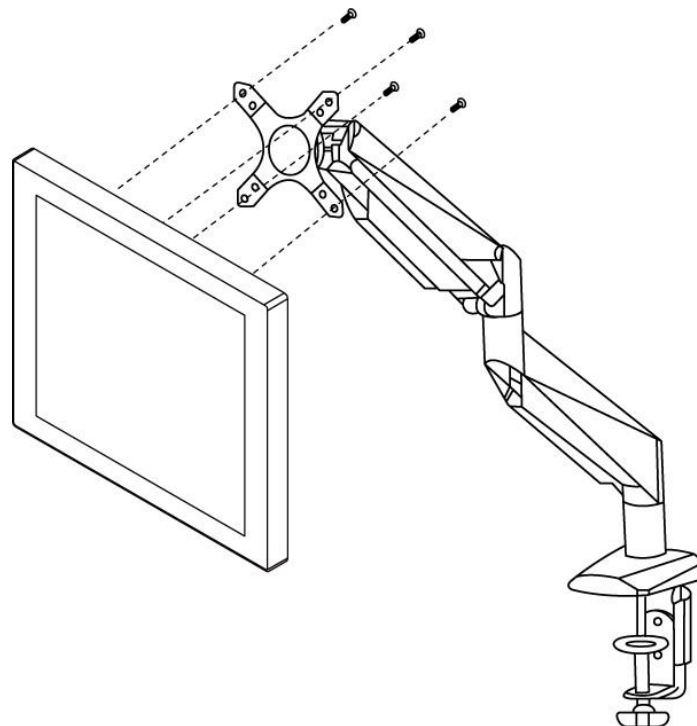

NOTE:

Notice that both hooks on bracket should lock the notches on the back cover of the device.

6.3.2 Yoke Mount

Yoke Mount solution allows installing the Panel PC with the bracket (not supplied by Winmate).

Mounting instruction:

1. Place the Panel PC on the bracket stand, aiming screw holes for each other.
2. Secure screws to fix the device upon the bracket stand.
3. Firmly secure the locking handle to the Panel PC.

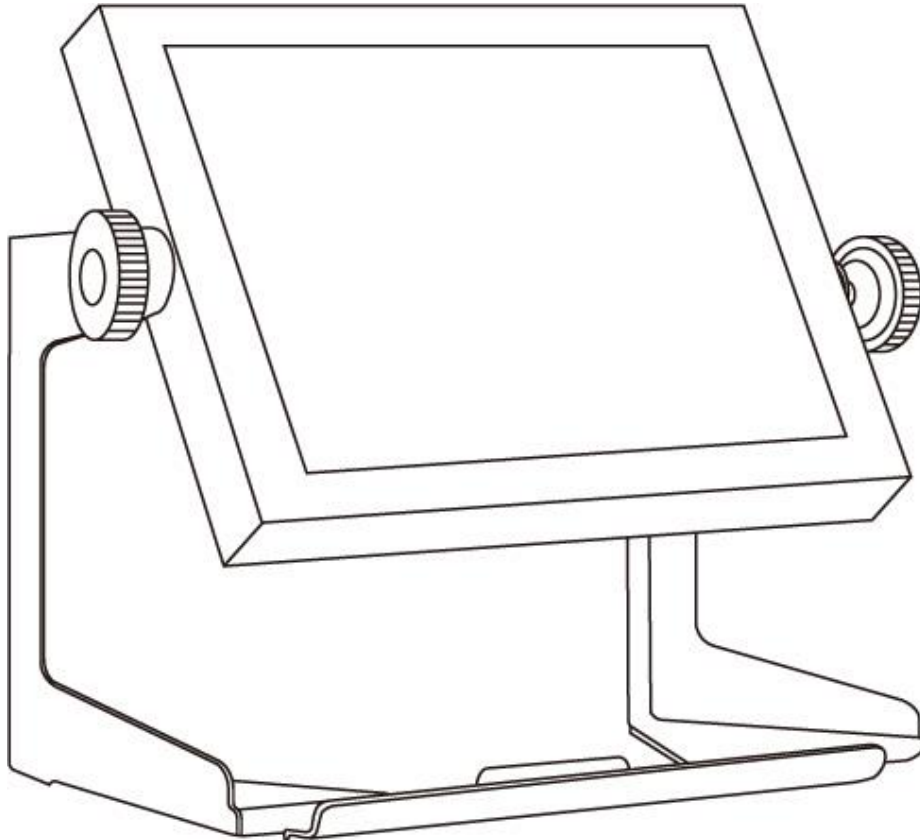

Chapter 7: Technical Support

This chapter includes technical support documents and software developing kit (SDK). If any problem occurs fill in [problem report form](#) enclosed and immediately contact us.

7.1 Software Developer Support

Winmate provides the following SDK and Utilities for the IP69K Stainless P-CAP Panel PC.

Item	File Type	Description
1	SDK	Watchdog SDK
2	Utility	Watchdog Utility

To find the Drivers and SDK, please refer to the Driver CD that comes in the package or contact us. Also, you can download drivers from Winmate Download Center.

Winmate Download Center

Go to <http://www.winmate.com.tw/> > Support > Download Center > Full IP65/IP69K Stainless PPC > IP69 Flat PCAP Series – Bay Trail

Appendix A: Product Specifications

Hardware Specifications

	Model Name				
	R10IB3S-SPT269	R15IB3S-SPC369	R19IB3S-SPM169	W22IB3S-SPA369	W24IB3S-SPA269
Display					
Size	10.4"	15"	19"	21.5"	23.8"
Resolution	1024 x 768	1024 x 768	1280 x 1024	1920 x 1080	1920 x 1080
Brightness	350 <i>cd/m²</i>	300 <i>cd/m²</i>	250 <i>cd/m²</i>	250 <i>cd/m²</i>	250 <i>cd/m²</i>
Contrast Ratio	1000:1(typ.)	2000:1(typ.)	1000:1(typ.)	3000:1(typ.)	3000:1(typ.)
Viewing Angle	-88~88(H); -88~88(V)	-88~88(H); -88~88(V)	-85~85(H); -80~80(V)	-89~89(H); -89~89(V)	-89~89(H); -89~89(V)
Max Colors	16.2M	16.2M	16.7M	16.7M	16.7M
Touch	P-Cap (Default), Glass (Optional)	P-Cap (Default), Glass(Optional), AG Coating (Optional)	P-Cap (Default), Glass (Optional), AG Coating (Optional)	P-Cap (Default), Glass (Optional), AG Coating (Optional)	P-Cap (Default), Glass (Optional)
System					
Processor	Intel® Celeron® Bay Trail-M N2930, 1.83 GHz	Intel® Celeron® Bay Trail-M N2930, 1.83 GHz	Intel® Celeron® Bay Trail-M N2930, 1.83 GHz	Intel® Celeron® Bay Trail-M N2930, 1.83 GHz	Intel® Celeron® Bay Trail-M N2930, 1.83 GHz
BIOS	AMI 16Mbit Flash	AMI 16Mbit Flash	AMI 16Mbit Flash	AMI 16Mbit Flash	AMI 16Mbit Flash
System Chipset	Intel® Atom™ SoC Integrate	Intel® Atom™ SoC Integrate	Intel® Atom™ SoC Integrate	Intel® Atom™ SoC Integrate	Intel® Atom™ SoC Integrate
System Memory	1 x SO-DIMM (default 4GB, max. 8GB DDR3L 1600)	1 x SO-DIMM (default 4GB, max. 8GB DDR3L 1600)	1 x SO-DIMM (default 4GB, max. 8GB DDR3L 1600)	1 x SO-DIMM (default 4GB, max. 8GB DDR3L 1600)	1 x SO-DIMM (default 4GB, max. 8GB DDR3L 1600)
Storage	Default 64GB	Default 64GB	Default 64GB	Default 64GB	Default 64GB
Graphic Chipset	Integrated HD Graphics	Integrated HD Graphics	Integrated HD Graphics	Integrated HD Graphics	Integrated HD Graphics
Audio	Built in ALC886 HD Audio Codec	Built in ALC886 HD Audio Codec	Built in ALC886 HD Audio Codec	Built in ALC886 HD Audio Codec	Built in ALC886 HD Audio Codec
Ethernet	2 x RJ45 Gigabit LAN (1 x RJ45 internal)	2 x RJ45 Gigabit LAN (1 x RJ45 internal)	2 x RJ45 Gigabit LAN (1 x RJ45 internal)	2 x RJ45 Gigabit LAN (1 x RJ45 internal)	2 x RJ45 Gigabit LAN (1 x RJ45 internal)
USB	6 x USB2.0 (4 x USB internal), 4 x RS232 (3 x RS232 internal)	6 x USB2.0 (4 x USB internal), 4 x RS232 (3 x RS232 internal)	6 x USB2.0 (4 x USB internal), 4 x RS232 (3 x RS232 internal)	6 x USB2.0 (4 x USB internal), 4 x RS232 (3 x RS232 internal)	6 x USB2.0 (4 x USB internal), 4 x RS232 (3 x RS232 internal)
Expansion Slot	1 x Mini PCIe (Internal)	1 x Mini PCIe (Internal)	1 x Mini PCIe (Internal)	1 x Mini PCIe (Internal)	1 x Mini PCIe (Internal)

	Model Name				
	R10IB3S-SPT269	R15IB3S-SPC369	R19IB3S-SPM169	W22IB3S-SPA369	W24IB3S-SPA269
SSD Interface	1 x Mini PCIe SSD	1 x Mini PCIe SSD	1 x Mini PCIe SSD	1 x Mini PCIe SSD	1 x Mini PCIe SSD
Power Input	DC-IN (Lockable, Power Jack)	DC-IN (Lockable, Power Jack)	DC-IN (Lockable, Power Jack)	DC-IN (Lockable, Power Jack)	DC-IN (Lockable, Power Jack)
Input/ Output Connectors					
Ethernet LAN	1 x RJ45 - 10/100/1000 Mbps	1 x RJ45 - 10/100/1000 Mbps	1 x RJ45 - 10/100/1000 Mbps	1 x RJ45 - 10/100/1000 Mbps	1 x RJ45 - 10/100/1000 Mbps
COM	1 x RS232	1 x RS232	1 x RS232	1 x RS232	1 x RS232
USB	2 x USB Type-A Receptacle	2 x USB Type-A Receptacle	2 x USB Type-A Receptacle	2 x USB Type-A Receptacle	2 x USB Type-A Receptacle
Power	1 x 12V DC	1 x 12V DC	1 x 12V DC	1 x 12V DC	1 x 12V DC
Mechanical Specification					
Cooling System	Fanless	Fanless	Fanless	Fanless	Fanless
Housing	Stainless steel SUS 316/ AISI 316	Stainless steel SUS 316/ AISI 316	Stainless steel SUS 316/ AISI 316	Stainless steel SUS 316/ AISI 316	Stainless steel SUS 316/ AISI 316
Mounting	Yoke Mount, VESA Mount	Yoke Mount, VESA Mount	Yoke Mount, VESA Mount	Yoke Mount, VESA Mount	Yoke Mount, VESA Mount
Environmental Consideration					
Operating Temperature	0°C to +45°C	0°C to +45°C	0°C to +45°C	0°C to +45°C	0°C to +45°C
Operating Humidity	30% to 90% (non-condensing)	30% to 90% (non-condensing)	30% to 90% (non-condensing)	30% to 90% (non-condensing)	30% to 90% (non-condensing)
IP Rating	Full IP69K	Full IP69K	Full IP69K	Full IP69K	Full IP69K
Power Specifications					
Power Input	12V DC IN	12V DC IN	12V DC IN	12V DC IN	12V DC IN
Power Consumption	33W (typ.)	38W (typ.)	45W (typ.)	56W (typ.)	56W (typ.)
Standards and Certification					
Certification	CE, FCC, RoHs	CE, FCC, RoHs	CE, FCC, RoHs	CE, FCC, RoHs	CE, FCC, RoHs

NOTE:

- Accessories and Integrated Options may vary depending on your configuration. The product shown in this datasheet is a standard model. For diagrams that contain customized or optional I/O, please contact the Winmate Sales Team for more information.
- All specifications are subject to change without prior notice.

Software Support – Drivers

Item	Driver	Windows 7	Windows 8	Windows 10
1	Chipset Driver	<input checked="" type="checkbox"/>	<input checked="" type="checkbox"/>	<input checked="" type="checkbox"/>
2	Graphics Driver	<input checked="" type="checkbox"/>	<input checked="" type="checkbox"/>	<input checked="" type="checkbox"/>
3	Audio Driver	<input checked="" type="checkbox"/>	<input checked="" type="checkbox"/>	<input checked="" type="checkbox"/>
4	Intel Sideband Fabric Device (Intel MBI) Driver	<input type="checkbox"/>	<input checked="" type="checkbox"/>	<input checked="" type="checkbox"/>
5	Intel Trusted Engine Interface (Intel TXE) Driver	<input checked="" type="checkbox"/>	<input checked="" type="checkbox"/>	<input checked="" type="checkbox"/>
6	USB 3.0 Driver	<input checked="" type="checkbox"/>	<input type="checkbox"/>	<input type="checkbox"/>
7	Watchdog Driver	<input checked="" type="checkbox"/>	<input checked="" type="checkbox"/>	<input checked="" type="checkbox"/>

Software Support- SDK

Item	File Type	Description
1	Watchdog SDK & AP	Watchdog SDK and AP

Appendix B: Order Information

The IP69K Flat Stainless P-CAP Panel PC available for ordering in the following configurations.

SBC		Panel PC	
RAM	SODIMM DDR3L Max 8GB	OS	Windows 10 IoT Enterprise Windows Embedded 8.1 Industry Pro Windows Embedded 8 Standard Windows Embedded 7 Standard
Storage	Mini PCIe SSD	Touch	Glass



Winmate Inc.
9F, No.111-6, Shing-De Rd., San-Chung District,
New Taipei City 24158, Taiwan, R.O.C
www.winmate.com

Copyright © 2022 Winmate Inc. All rights reserved.

