

**SE-103-N**  
**Intel® Atom® x6000**  
**Fanless Signage Player**

**User's Manual**

Version 1.0  
(October 2022)



## **Copyright**

© 2022 IBASE Technology, Inc. All rights reserved.

No part of this publication may be reproduced, copied, stored in a retrieval system, translated into any language or transmitted in any form or by any means, electronic, mechanical, photocopying, or otherwise, without the prior written consent of IBASE Technology, Inc. (hereinafter referred to as "IBASE").

## **Disclaimer**

IBASE reserves the right to make changes and improvements to the products described in this document without prior notice. Every effort has been made to ensure the information in the document is correct; however, IBASE does not guarantee this document is error-free. IBASE assumes no liability for incidental or consequential damages arising from misapplication or inability to use the product or the information contained herein, nor for any infringements of rights of third parties, which may result from its use.

## **Trademarks**

All the trademarks, registrations and brands mentioned herein are used for identification purposes only and may be trademarks and/or registered trademarks of their respective owners.

## Compliance



In a domestic environment, this product may cause radio interference in which case users may be required to take adequate measures.



This product has been tested and found to comply with the limits for a Class B device, pursuant to Part 15 of the FCC Rules. These limits are designed to provide reasonable protection against harmful interference in a residential installation. This equipment generates, uses and can radiate radio frequency energy and, if not installed and used in accordance with manufacturer's instructions, may cause harmful interference to radio communications.

### WEEE



This product must not be disposed of as normal household waste, in accordance with the EU directive of for waste electrical and electronic equipment (WEEE - 2012/19/EU). Instead, it should be disposed of by returning it to a municipal recycling collection point. Check local regulations for disposal of electronic products.

### Green IBASE



This product is compliant with the current RoHS restrictions and prohibits use of the following substances in concentrations exceeding 0.1% by weight (1000 ppm) except for cadmium, limited to 0.01% by weight (100 ppm).

- Lead (Pb)
- Mercury (Hg)
- Cadmium (Cd)
- Hexavalent chromium (Cr6+)
- Polybrominated biphenyls (PBB)
- Polybrominated diphenyl ether (PBDE)

## Important Safety Information

Carefully read the precautions before using the device.

### Environmental conditions:

- Lay the device horizontally on a stable and solid surface in case the device may fall, causing serious damage.
- Leave plenty of space around the device and do not block the openings for ventilation. NEVER DROP OR INSERT ANY OBJECTS OF ANY KIND INTO THE VENTILATION OPENINGS.
- Use this product in environments with ambient temperatures between 0°C and 45°C.
- DO NOT LEAVE THIS DEVICE IN AN ENVIRONMENT WHERE THE STORAGE TEMPERATURE MAY IS BELOW -20° C OR ABOVE 80° C. This could damage the device. The device must be used in a controlled environment.

### Care for iBASE products:

- Before cleaning the device, turn it off and unplug all cables such as power in case a small amount of electrical current may still flow.
- Use neutral cleaning agents or diluted alcohol to clean the device chassis with a cloth. Then wipe the chassis with a dry cloth.
- Vacuum the dust with a computer vacuum cleaner to prevent the air vent or slots from being clogged.



## WARNING

### Attention during use:

- Do not place heavy objects on the top of the device.
- Operate this device from the type of power indicated on the marking label. If you are not sure of the type of power available, consult the distributor or local power company.
- Do not walk on the power cord or allow anything to rest on it.
- If you use an extension cord, make sure that the total ampere rating of the product plugged into the extension cord does not exceed its limits.

### Avoid Disassembly

Do not disassemble, repair or make any modification to the device. Doing so could generate hazards and cause damage to the device, even bodily injury or property damage, and will void any warranty.



## CAUTION

There is danger of explosion if internal lithium-ion battery is replaced by an incorrect type. Replace only with the same or equivalent type recommended by the manufacturer. Dispose of used batteries according to the manufacturer's instructions.

## Warranty Policy

- **IBASE standard products:**

24-month (2-year) warranty from the date of shipment. If the date of shipment cannot be ascertained, the product serial numbers can be used to determine the approximate shipping date.
- **3<sup>rd</sup>-party parts:**

12-month (1-year) warranty from delivery for the 3<sup>rd</sup>-party parts that are not manufactured by IBASE, such as CPU, CPU cooler, memory, storage devices, power adapter, panel and touchscreen.
- \* PRODUCTS, HOWEVER, THAT FAIL DUE TO MISUSE, ACCIDENT, IMPROPER INSTALLATION OR UNAUTHORIZED REPAIR SHALL BE TREATED AS OUT OF WARRANTY AND CUSTOMERS SHALL BE BILLED FOR REPAIR AND SHIPPING CHARGES.

## Technical Support & Services

1. Visit the IBASE website at [www.ibase.com.tw](http://www.ibase.com.tw) to find the latest information about the product.
2. If you need any further assistance from the distributor or sales representative, prepare the following information:
  - Product model name
  - Product serial number
  - Detailed description of the problem
  - The error messages in text or in screenshots if there is any
  - The arrangement of the peripherals
  - Software in use (such as OS and application software, including the version numbers)
3. If repair service is required, you can download the RMA form at <http://www.ibase.com.tw/english/Supports/RMAService/>. Fill out the form and contact the distributor or sales representative.

# Table of Contents

---

<b>Chapter 1</b>	<b>General Information .....</b>	<b>1</b>
1.1	Introduction .....	2
1.2	Features .....	2
1.3	Packing List .....	3
1.4	Specifications .....	3
1.5	Product View .....	5
1.6	Dimensions .....	7
<b>Chapter 2</b>	<b>Hardware Installation &amp; Motherboard Information .....</b>	<b>8</b>
2.1	Installation / Replacement .....	9
2.2	Setting the Jumpers .....	14
2.3	Jumper & Connector Locations on Motherboard .....	15
<b>Chapter 3</b>	<b>Driver Installation .....</b>	<b>20</b>
3.1	Introduction .....	21
3.2	Intel® Chipset Software Installation Utility .....	21
3.3	VGA Driver Installation .....	23
3.4	HD Audio Driver Installation .....	25
3.5	Intel® ME Drivers Installation .....	26
3.6	Observer Utility Installation .....	28
3.7	LAN Drivers Installation .....	29
<b>Chapter 4</b>	<b>BIOS Setup .....</b>	<b>31</b>
4.1	Introduction .....	32
4.2	BIOS Setup .....	32
4.3	Main Settings .....	33
4.4	Advanced Settings .....	33
4.5	Chipset Settings .....	44
4.6	Security Settings .....	47
4.7	Boot Settings .....	49
4.8	Save & Exit Settings .....	50
<b>Appendix</b>	<b>.....</b>	<b>51</b>
A.	I/O Port Address Map .....	52
B.	Interrupt Request Lines (IRQ) .....	54

# Chapter 1

## General Information

The information provided in this chapter includes:

- Features
- Packing List
- Accessories
- Specifications
- Product View
- Dimensions

## 1.1 Introduction

The SE-103-N is a fanless digital signage player that leverages the Intel® x6000 family processors that can be install in commercial establishments to increase brand awareness and customer engagement or deployed in transportation networks to provide real-time information and advertising relevant to the traveler.

The fanless SE-103-N offers high performance and high reliability for 24/7 operation in an industrial-grade design and is integrated with the IBASE iSMART and Observer technologies for remote monitoring, power on/off scheduling, power recovery and low temperature boot functions. The system supports three independent displays (3x HDMI 2.0b with HDMI-CEC display on/off control function), up to 32GB DDR4-3200 memory, and Intel® 2.5GbE LAN, as well as M.2 B-Key (3052) socket for 5G options and M.2 E-Key (2230) socket for Wi-Fi, Bluetooth or capture card options.

## 1.2 Features

- iSMART energy-saving & Observer remote monitoring technologies
- Intel® Atom® x6000/ Pentium® / Celeron® Processors
- 3x HDMI 2.0b with HDMI-CEC display on/off control function
- Built-in hardware EDID emulation with S/W control function
- 2x DDR4-3200 SO-DIMM, Dual channel, Max. 32GB
- 1x Intel® 2.5GbE LAN
- 1x M.2 B-Key (3052) for 5G options
- 1x M.2 E-Key (2230) for Wi-Fi, Bluetooth or capture card options
- TPM 2.0 and watchdog timer
- Wide-range operating temperature from -20°C to 70°C





### 1.3 Packing List

The product package should include the items listed below. If any of the items below is missing, contact the distributor or the dealer from whom you purchased the product.

- SE-103-N Digital Signage Player
- Power Adaptor
- Power Cord

### 1.4 Specifications

Product	SE-103-N	
Mainboard		
Mainboard	MBD103	MBD103-6210
CPU Type	Atom® x6425E	Celeron® N6210
CPU Speed	1.8GHz 3.0GHz	1.2GHz 2.6GHz
Cache	1.5MB	1.5MB
System		
Operating System	Win10 IoT Enterprise (64-bit) Linux Ubuntu (64-bit)	
CPU	Intel® Atom® x6425E (2.0~3.0GHz) Intel® Celeron® N6210 (1.2~2.6GHz)	
Chipset	SoC Integrated	
Memory	2x DDR4-3200 SO-DIMM, dual channel, Max. 32GB <b>Supports IB ECC for x6000 Series CPU</b>	
Graphics	11th Gen Intel® SoC integrated 18EUs graphics device	
LAN Controller	1x Intel® I225IT 2.5GbE LAN for Atom® x6000 series 1x Intel® I225V 2.5GbE LAN for Celeron®/ Pentium®	
Expansion Slots	1x M.2 E-Key (2230), 1x M.2 B-Key (3052) 1x UIM/SIM card slot	
Storage	1x M.2 M-Key (2280)	
Power	+12V DC	
Chassis	Aluminum + SGCC, black & white	
Mounting	Standard system bracket	

<b>I/O Interface</b>	3x HDMI 2.0b 3x USB 3.1 (Gen.2) 1x RJ45 for 2.5GbE LAN 1x RJ45 for RS232/422/485 serial port 2x Audio connectors for Line-in / Line-out 1x Power button 1x Terminal block for power port 1x UIM/SIM card slot 1x Power / HDD LED 4x DI, 4x DO pin header (w/o isolation) (Internal)	
<b>TPM</b>	2.0	
<b>Auto Control &amp; Monitoring</b>	Watchdog Timer: 256 segments, 0, 1, 2...255 (sec/min)	
<b>Dimensions (W x H x D)</b>	260mm(W) x 181.4mm(D) x 25mm(H) 10.24" (W) x 7.14" (D) x 0.98" (H)	
<b>Net Weight</b>	1.7Kg (3.75lbs)	
<b>Certificate</b>	CE, FCC class B, UL, CCC	
<b>Environment</b>		
<b>Temperature</b>	<b>MBD103 (CPU x6425E)</b>	<b>MBD103-6413 (CPU N6210)</b>
	Operating: -20°C ~ 85 °C (-4 ~ 185 °F)  Storage: -40°C ~ 110 °C (-40 ~ 230 °F)	Operating: 0°C ~ 60 °C (32 ~ 140 °F)  Storage: -20°C ~ 80 °C (-4 ~ 176 °F)
<b>Relative Humidity</b>	5 ~ 90% at 45 °C (non-condensing)	
<b>Vibration Protection</b>	SSD: random operation 5 grms, 5~500 Hz	

All specifications are subject to change without prior notice.

---

**Note:** The product performance relies on the system functioning as a whole. The level of CPU/APU/GPU processor, the interaction among the processor and the memory and storage bandwidth, or the functionality of the digital signage application software may affect the product performance.

---

## 1.5 Product View

### Front View



No.	Function	No.	Function
1	DC 12V Power Input Connector	7	Line out Connector
2	HDMI (Port C, A, B)	8	Power Button
3	(USB 3.1 Connectors)	9	Power Switch Connector
4	LAN Connector	A	EDID Clear Button
5	RS-232/422/485	B	Power LED
6	Line in Connector	C	HDD LED

### Front View



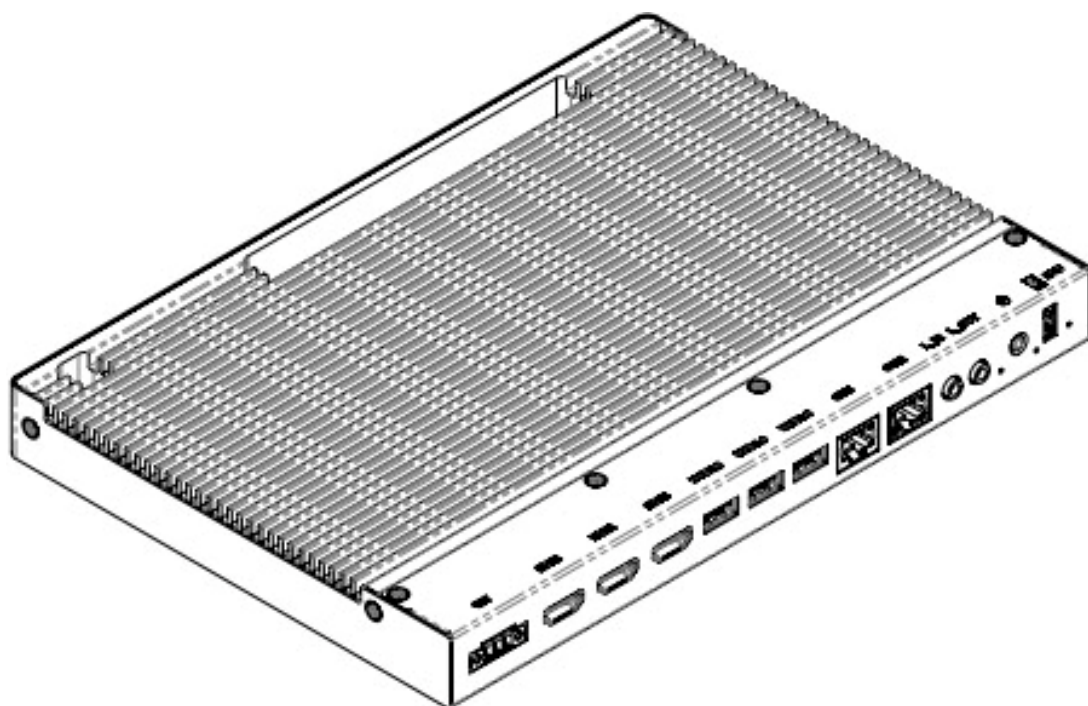
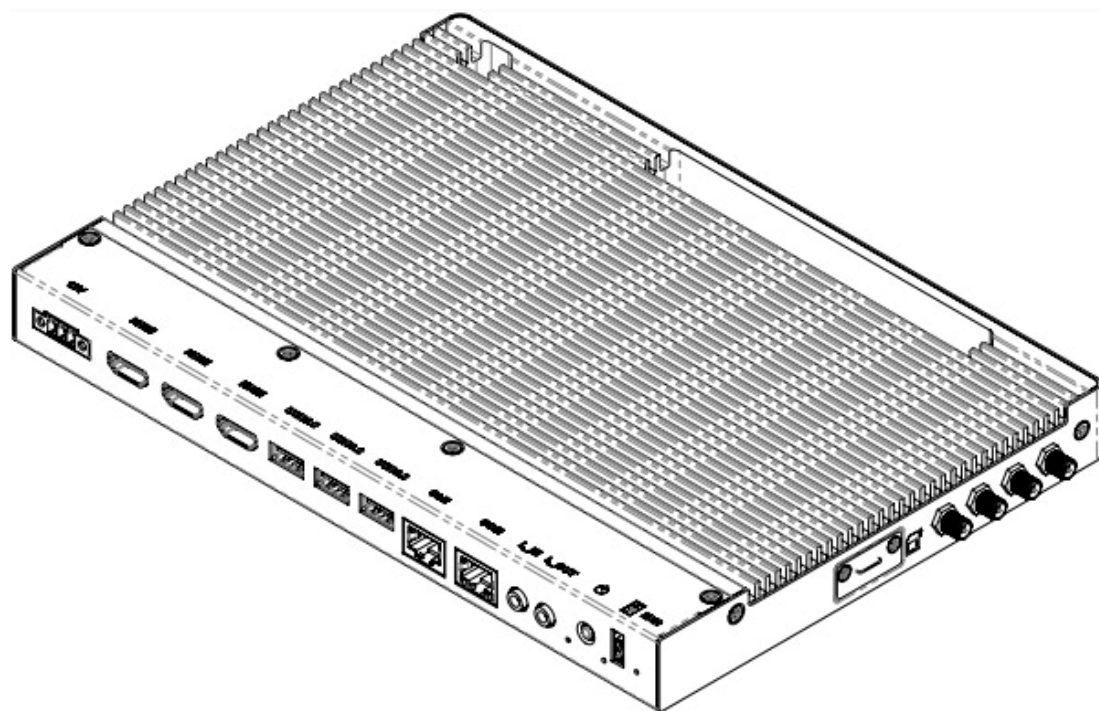

## 1.6 Dimensions

Unit: mm

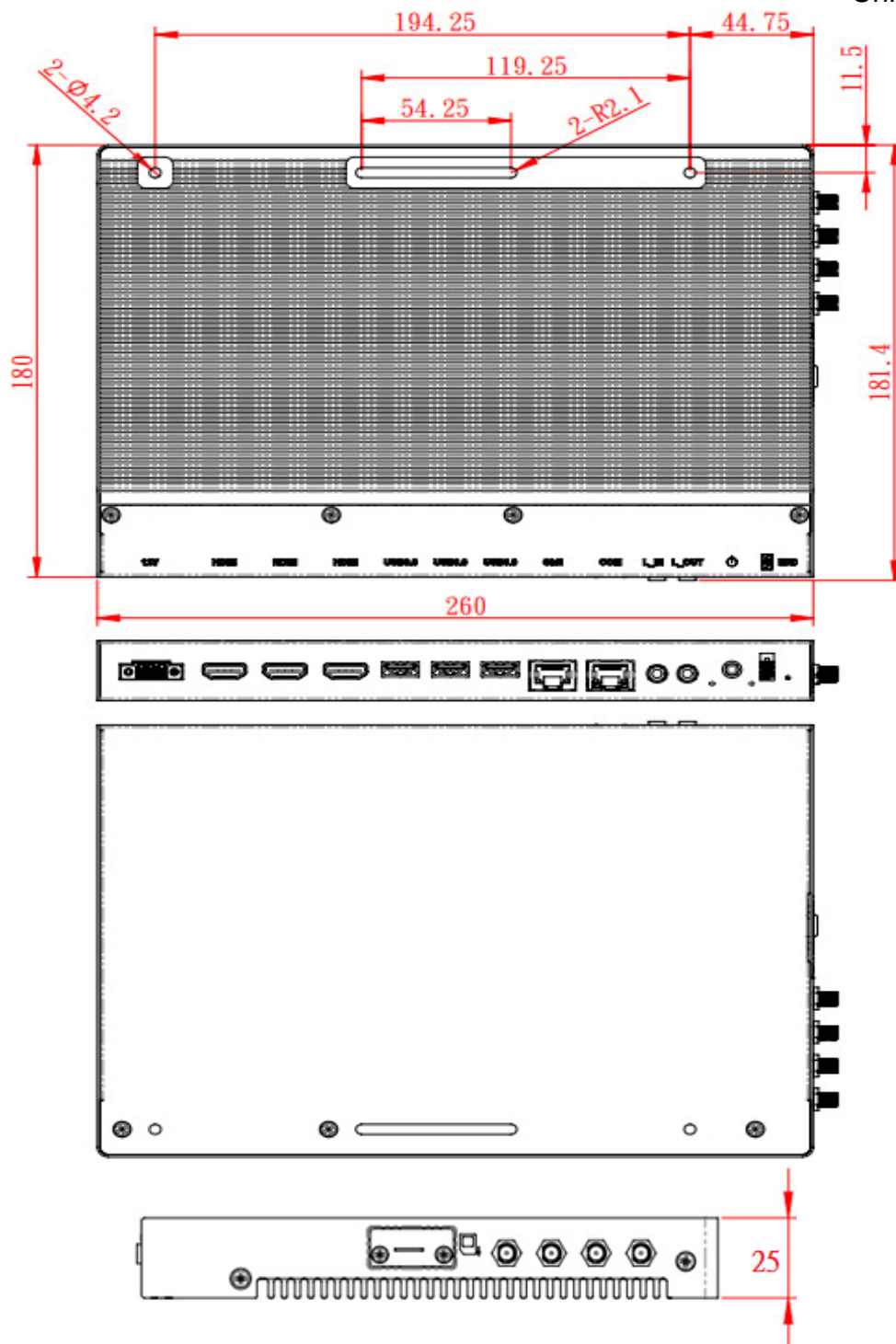

## **Chapter 2**

# **Hardware Installation & Motherboard Information**

The information provided in this chapter includes:

- Installation of memory, M.2 and mini PCIe card
- Information and locations of connectors



## 2.1 Installation / Replacement

The following pictures show how to disassemble the SE-103-N.

1. To use the SIM card slot, remove the two (2) screws as shown below.

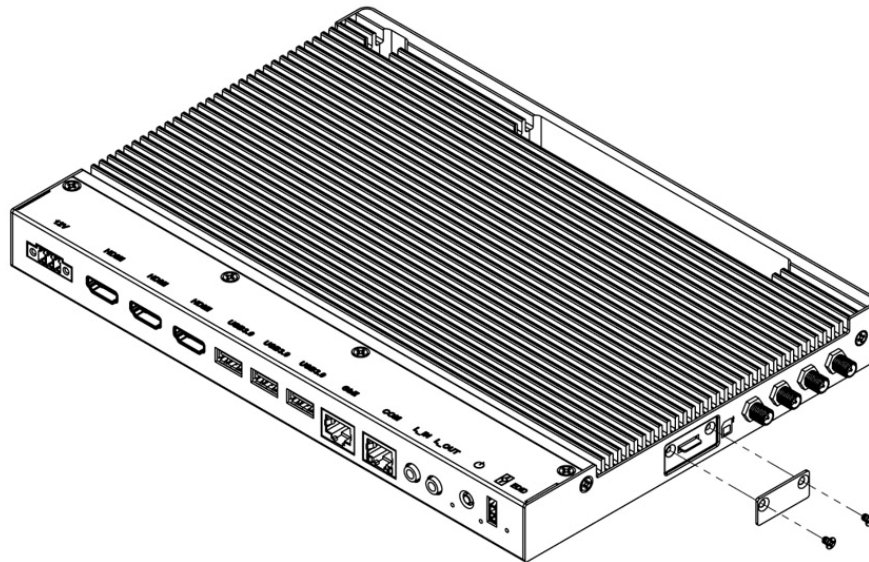

2. The following pictures show how to disassemble the system when replacing internal parts such as memory modules and M.2 cards.

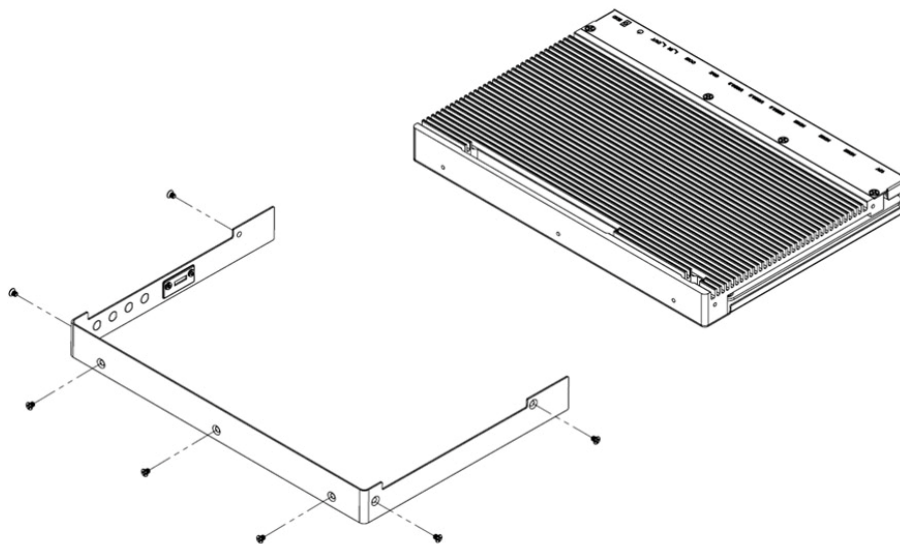

**Remove the cover.**

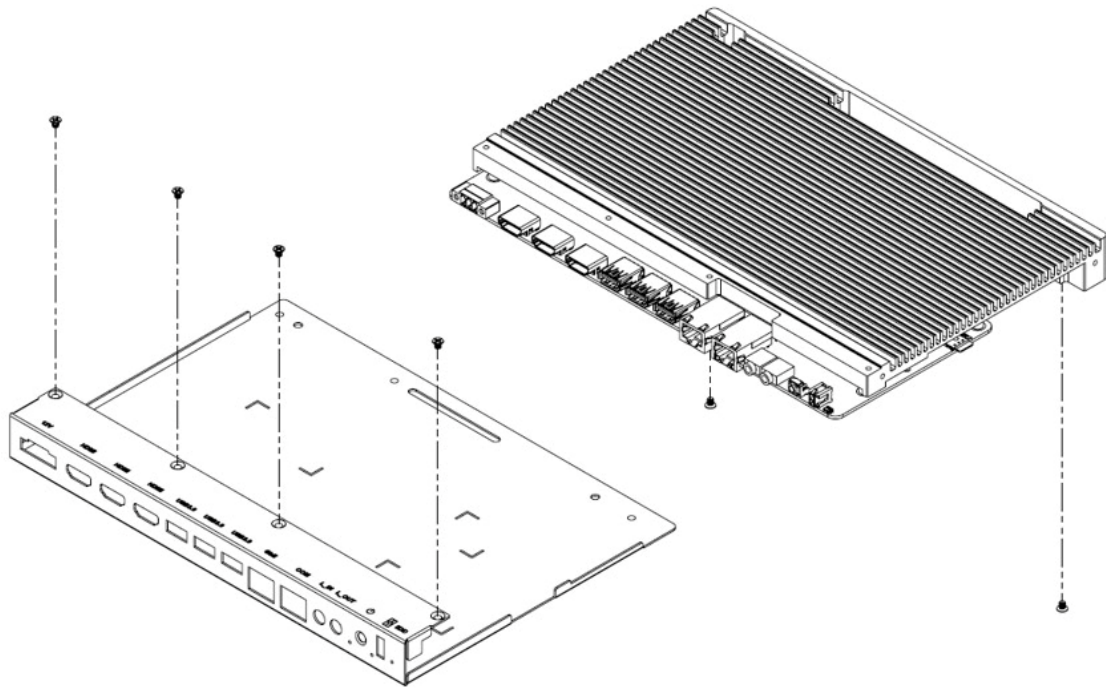

Separate the base and heatsink by releasing the six (6) screws shown above.

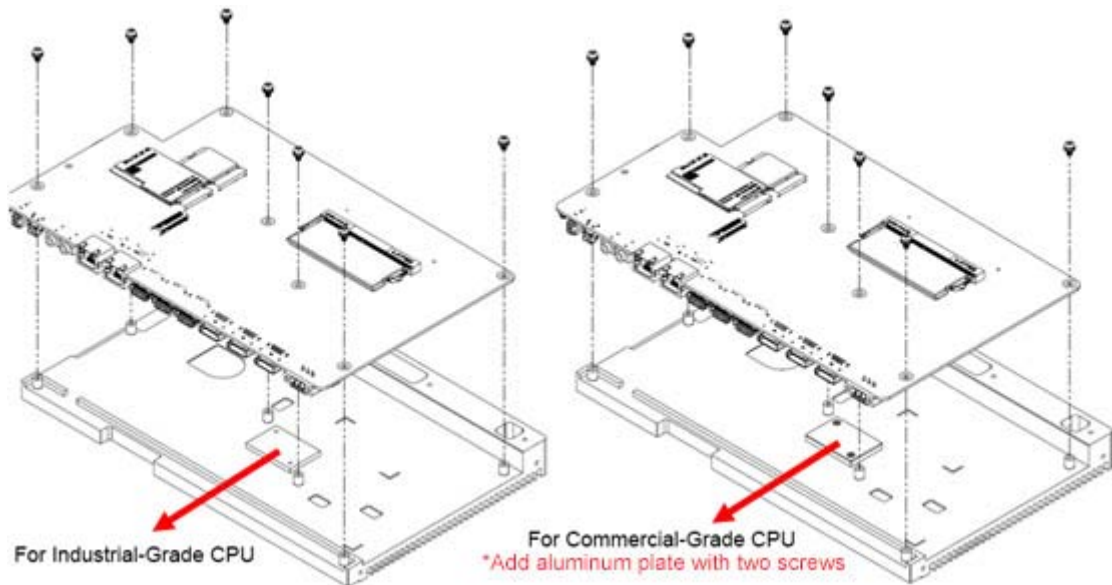

Disassemble the motherboard and heatsink by releasing the seven (7) screws shown above.

**Note:** Removing the main board to install the memory may damage the thermal pad and affect the thermal conductivity efficiency.



### 2.1.1 Memory

To install memory modules, locate the memory slot on the motherboard and perform the following steps:

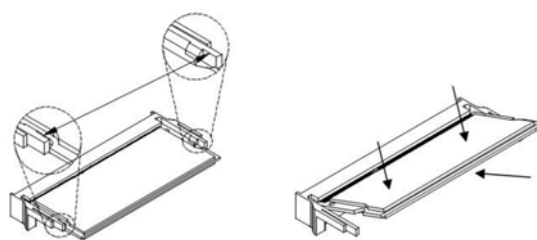
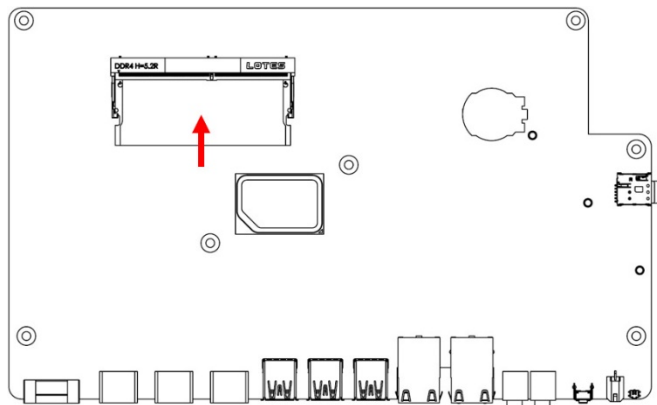
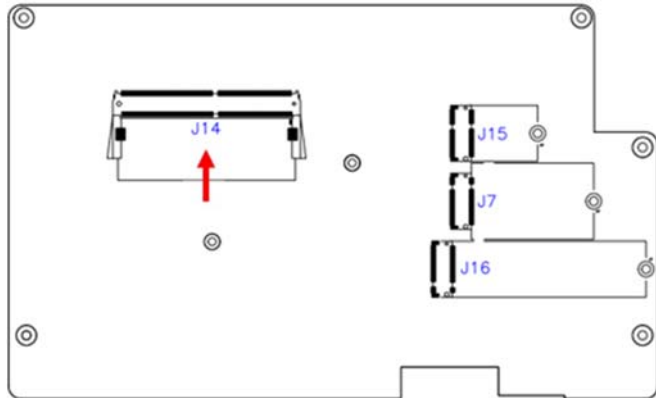

1. Align the key of the memory module with that on the memory slot and insert the module slantwise.
2. Gently push the module in an upright position until the clips of the slot close to hold the module in place when the module touches the bottom of the slot.

To remove the module, press the ejector tabs outwards with your fingertips to eject the module.

## 2.1.2 M.2 Cards

3. Locate the M.2 slot inside the device.
4. Align the key of the M.2 card to the interface, and insert the card slantwise.

Fix the M.2 card with an screw.

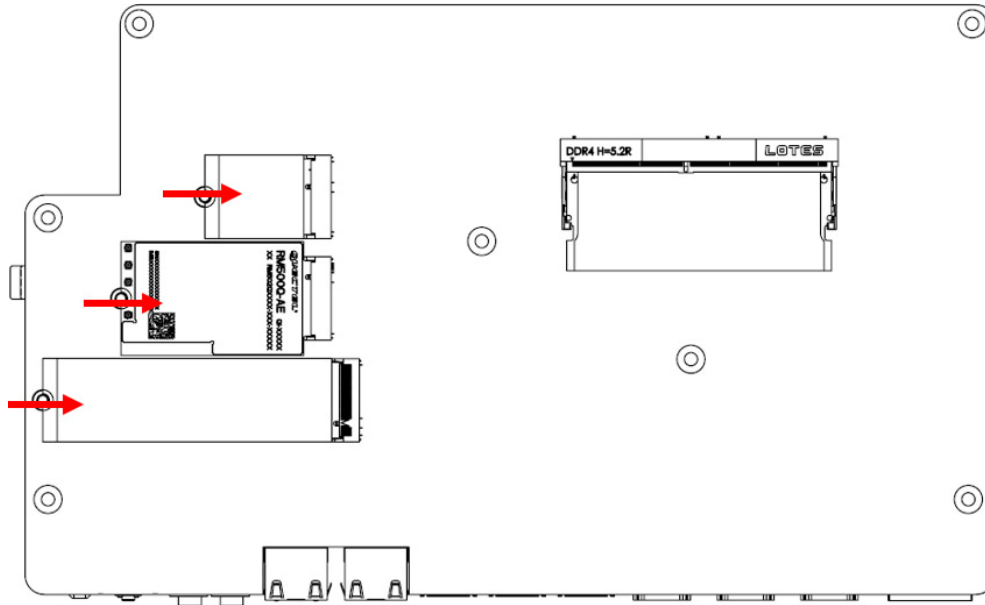

### 2.1.3 WiFi / 5G Antenna Installation

Thread the WiFi /5G antenna extension cable through an antenna hole of the front I/O cover and fasten the antenna as shown below. Then apply adhesive to the edge of the hex nut behind the front I/O cover to prevent the extension cable from falling if the cable becomes loose.

1. Thread and fasten the hex nut and the washer. Then install the antenna.

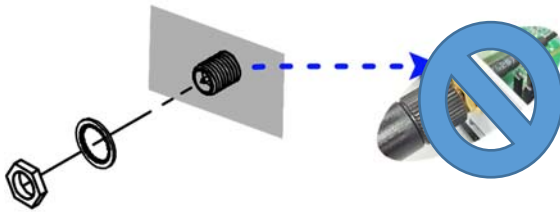

2. Apply adhesive around here.

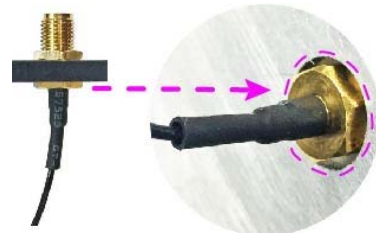

---

**Info:** The diameter of the nut is around 6.35 mm (0.25"-36UNC).

---

## 2.2 Setting the Jumpers

Set up and configure the SE-103-N by using jumpers for various settings and features according to the application requirements. Contact your supplier if you have doubts about the best configuration.

### 2.2.1 How to Set Jumpers

Jumpers are short-length conductors consisting of several metal pins with a non-conductive base mounted on the circuit board. Jumper caps are used to have the functions and features enabled or disabled. If a jumper has 3 pins, you can connect either PIN1 to PIN2 or PIN2 to PIN3 by shorting.

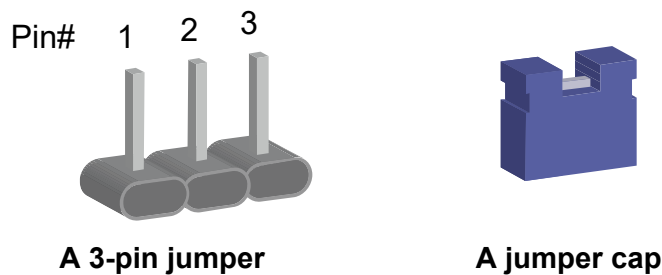

Refer to the illustration below to set jumpers.

Pin closed	Oblique view	Illustration
Open		
1-2		
2-3		

When two pins of a jumper are encased in a jumper cap, this jumper is **closed**, i.e. turned **On**.

When a jumper cap is removed from two jumper pins, this jumper is **open**, i.e. turned **Off**.

## 2.3 Jumper & Connector Locations on Motherboard

Motherboard: MBD103

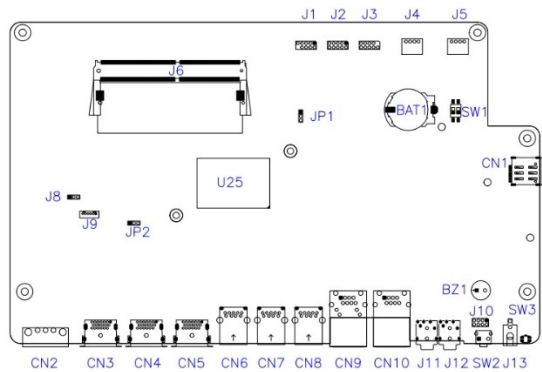

**MBD103 – top and I/O**

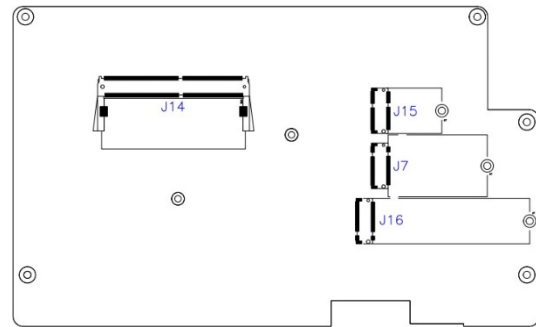

**MBD103 – back and I/O**

### Connectors Quick Reference

Connector	Function
CN1	SIM Card Slot
CN2	DC 12V Power Input Connector
CN3,CN4, CN5	HDMI Connectors (Port C, A, B)
CN6, CN7, CN8	USB3.1 Connector (Port 1, 0, 2)
CN9	LAN Connector
CN10	COM1 RS-232/422/485 Port
J1	Port 80 Connector (Factory used only)
J2	Digital I/O Connector
J3	SPI Flash Connector (Factory used only)
J4	Program iSmart MCU Connector (Factory used only)
J5	Program Clear RTC MCU Connector (Factory used only)
J6, J14	DDR4 Slots
J7	M.2 B-Key Connector
J8	Program VCORE Connector (Factory used only)
J9	Program CPLD Connector (Factory used only)
J10	Front Panel Connector (Optional)
J11	Audio Line-In Connector
J12	Audio Line-Out Connector
J13	Power Button Connector (Optional)
J15	M.2 E-Key Connector
J16	M.2 M-Key Connector
SW2	Power Button Connector
SW3	Clear EDID Button Connector

### 2.3.1 Jumper Quick Reference

Jumper / Switch	Function
SW1-1	Clear CMOS Data
SW1-2	Clear ME Register
JP1	ATX / AT Power Select
JP2	EDID Enable/Bypass Select

### 2.3.2 Clear CMOS Data (SW1-1)

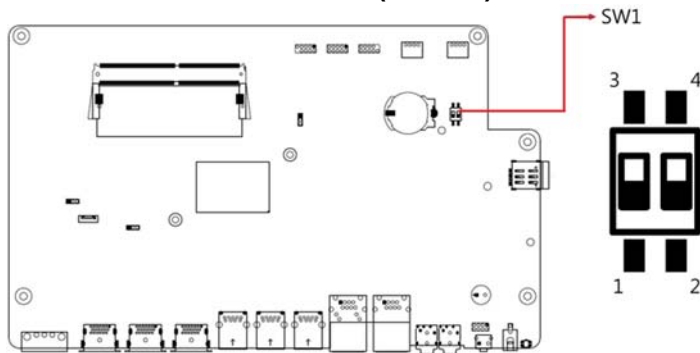

Function	Setting
Normal (default)	P1-OFF
Clear CMOS	P1-ON

### 2.3.3 Clear ME Register (SW1-2)

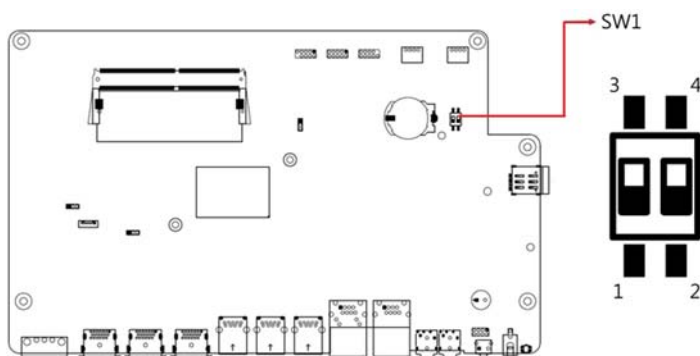

Function	Setting
Normal (default)	P2-OFF
Clear ME	P2-ON

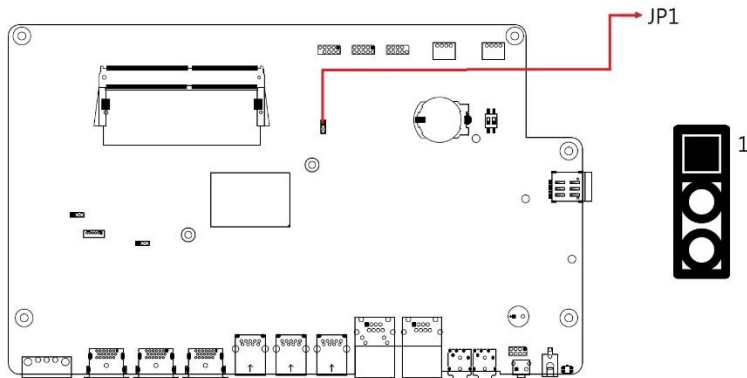

### 2.3.4 ATX / AT Power Selection (JP1)

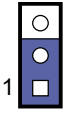
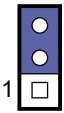

Function	Pin closed	Illustration
ATX (default)	1-2	
AT	2-3	

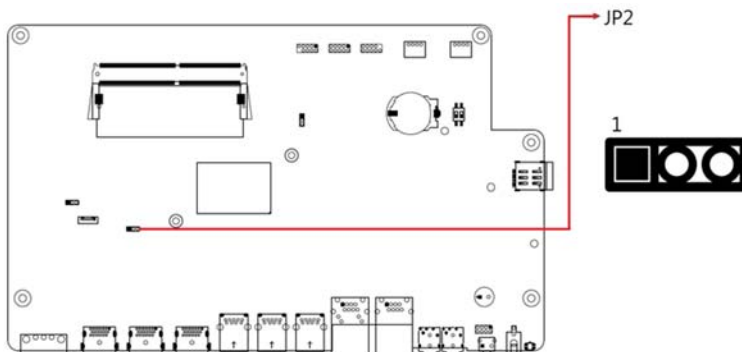
### 2.3.5 EDID Enable / Bypass Selection (JP2)



Function	Pin closed	Illustration
Enable (default)	1-2	
Bypass	2-3	

### 2.3.6 DC 12V Power Input Connector (CN2)

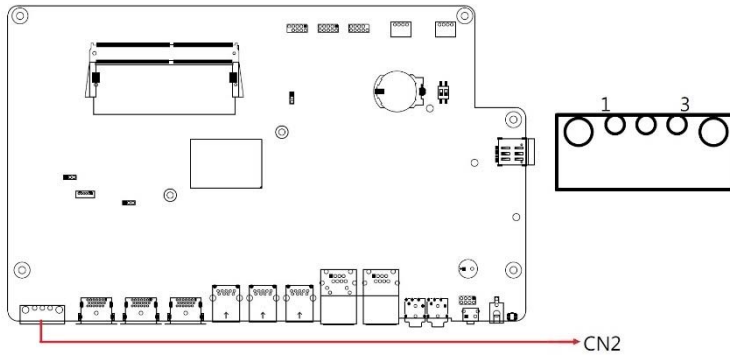

Pin	Assignment
1	Ground
2	NC
3	+12V

### 2.3.7 Digital I/O Connector (J2)

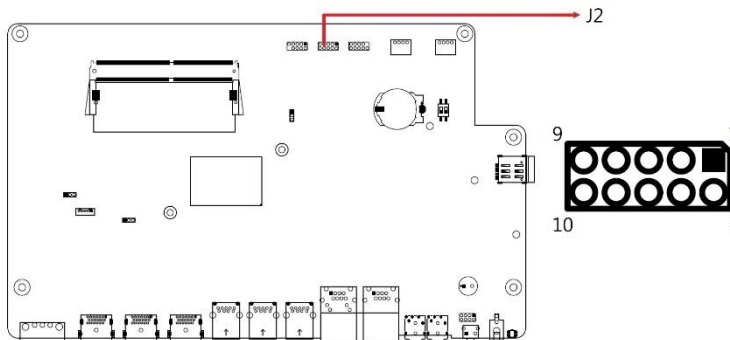

Pin	Assignment	Pin	Assignment
1	Ground	2	VCC
3	OUT3	4	OUT1
5	OUT2	6	OUT0
7	IN3	8	IN1
9	IN2	10	IN0





## Chapter 3

# Driver Installation

The information provided in this chapter includes:

- Intel® Chipset Software Installation Utility
- VGA Driver Installation
- HD Audio Driver Installation
- Intel® ME Drivers Installation

### 3.1 Introduction

This section describes the installation procedures of the software drivers. The software drivers are also available at the IBASE website [www.ibase.com.tw](http://www.ibase.com.tw).

---

**Note:** After installing the Windows operating system, install the Intel® Chipset Software Installation Utility first before proceeding with the drivers installation.

---

### 3.2 Intel® Chipset Software Installation Utility

The Intel® Chipset drivers should be installed first before the software drivers to install INF files for Plug & Play function for Intel chipset components.

1. Insert the drivers disk enclosed in the package. Click **Intel** on the left pane and then **Intel(R) Elkhartlake Chipset Drivers** on the right pane.



2. Click **Intel(R) Chipset Software Installation Utility**.



3. When the Welcome screen to the Intel® Chipset Device Software appears, click **Next** to continue.



4. Accept the software license agreement and proceed with the installation process.



5. On the Readme File Information screen, click **Install** for installation.



6. After the installation, press **Finish** to complete the setup process.

### 3.3 VGA Driver Installation

1. Insert the drivers disk enclosed in the package. Click **Intel** on the left pane and then **Intel(R) Elkhartlake Chipset Drivers** on the right pane.
2. Click **Intel(R) Elkhartlake Graphics Driver**.



3. On the following screen, click **Begin Installation**.



4. Click **I agree** to accept the license agreement.

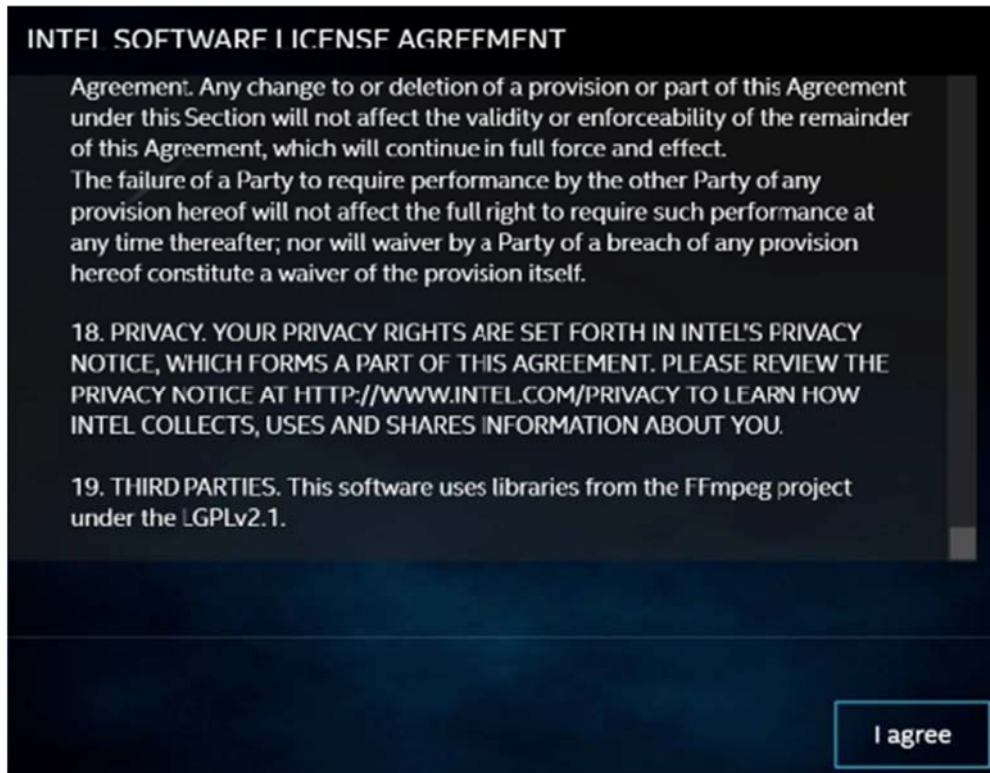

5. After the installation has been completed, click **Finish**.

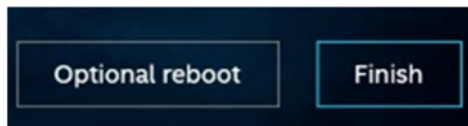

### 3.4 HD Audio Driver Installation

1. Insert the driver disks enclosed in the package. Click Intel on the left pane and then **Intel(R) Elkhartlake Chipset Drivers** on the right pane.
2. Click **Realtek High Definition Audio Driver**.



3. On the Welcome screen, click **Next** to continue.

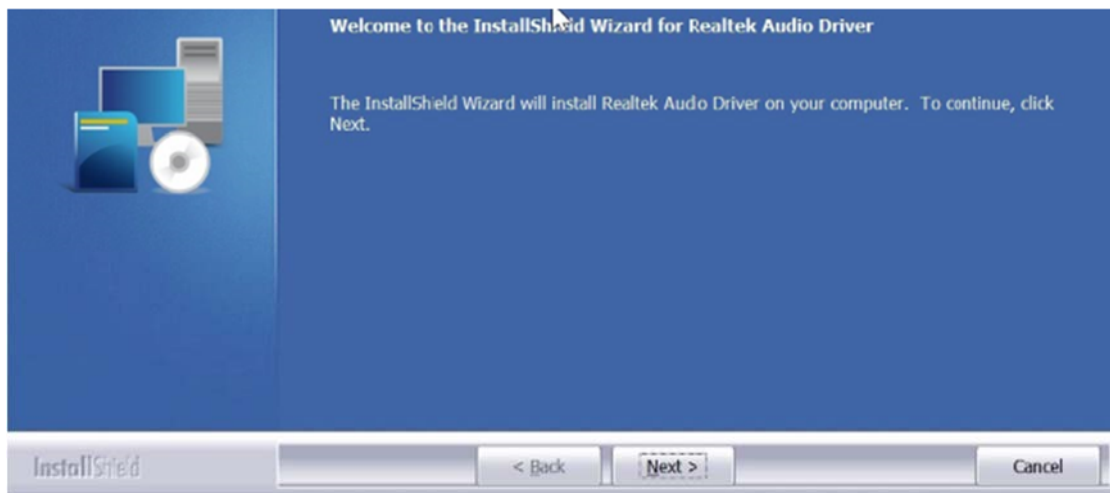

4. When the InstallShield Wizard has successfully installed the Realtek Audio Driver, click **Finish** to complete the setup.

## 3.5 Intel® ME Drivers Installation

1. Insert the drivers disk enclosed in the package. Click Intel on the left pane and then **Intel(R) ME Drivers**.



2. When the welcome screen to the Intel® Management Engine Components appears, click **Next** to continue.

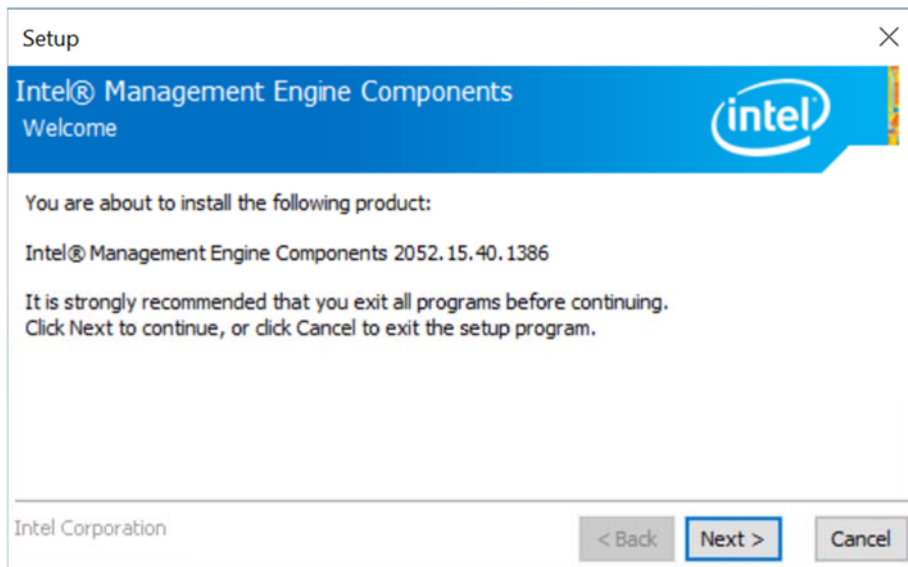



3. Accept the license agreement and click **Next**.

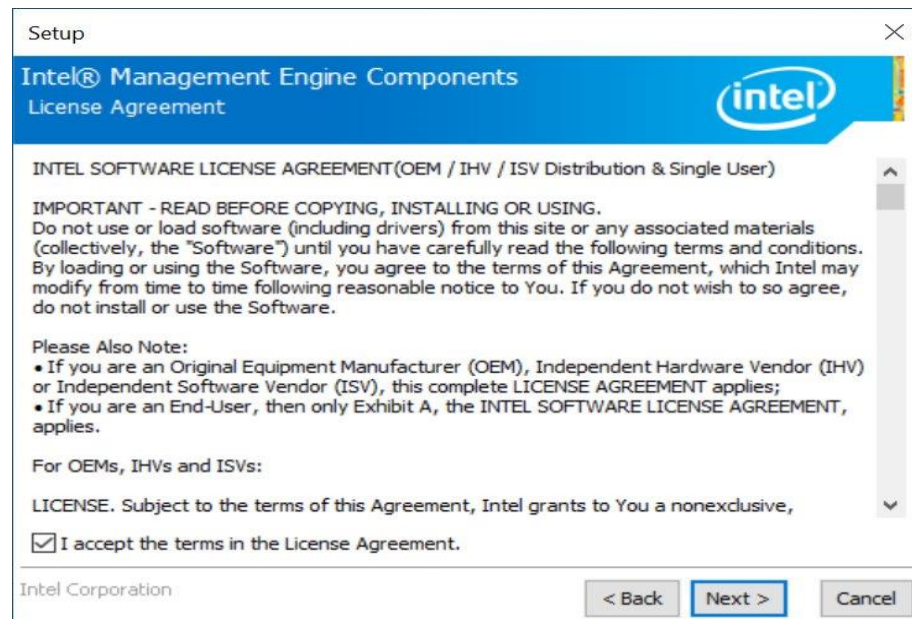

4. On the Setup's Destination Folder screen, click **Next** to continue.

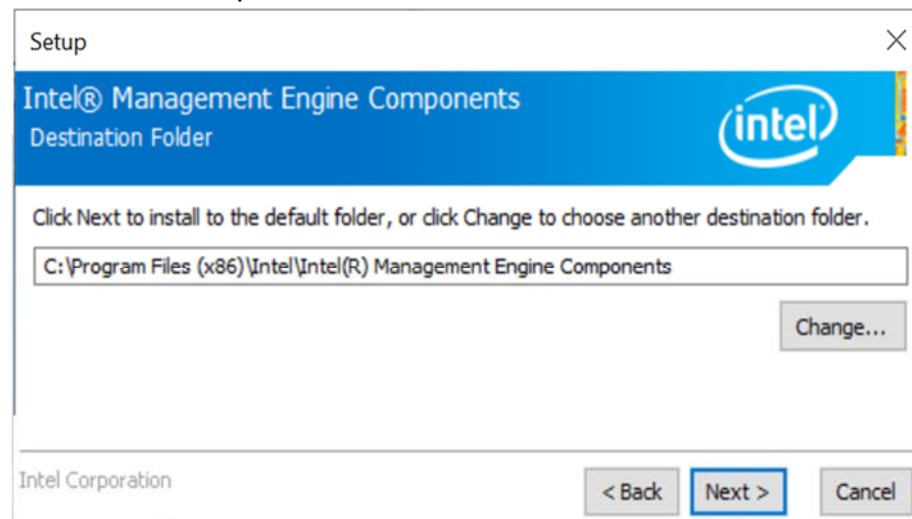

5. After the Intel® components have been completely installed, click **Finish**.

## 3.6 Observer Utility Installation

1. Insert the driver disk enclosed in the package. Click **Tools** on the left pane and then **Observer** on the right pane.



2. Click **Next** to accept the destination folder, or click **Browse** to select a different folder.

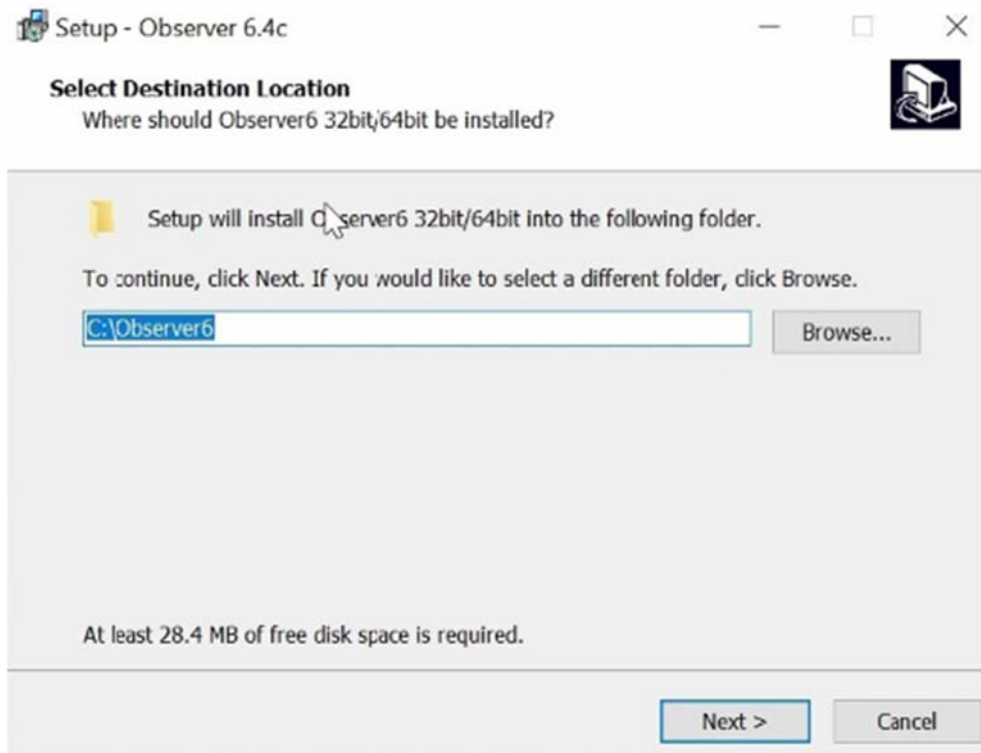

3. Click **Install** on the next screen to begin installation.

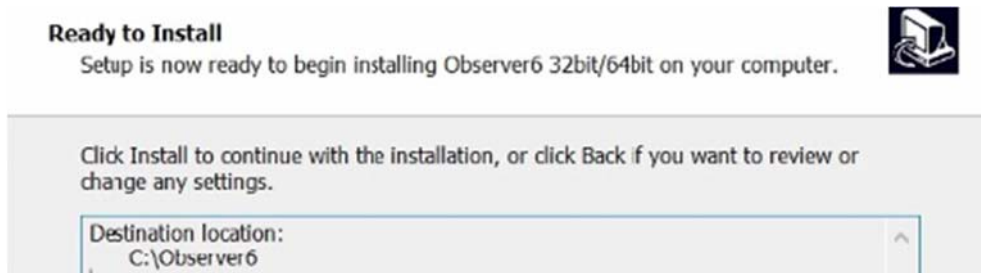

### 3.7 LAN Drivers Installation

1. Insert the driver disk enclosed in the package. Click **LAN Card** on the left pane and then **Intel LAN Controller Drivers** on the right pane.



2. Choose **Intel(R) I21x Gigabit Network Drivers**.



3. On the next screen, clic, **Install Drivers and Software**.



4. In the welcome screen to the install wizard for Intel(R) Network Connections, click **Next**.
5. On the next screen, accept the terms in the license agreement and click **Next**.

6. In the *Setup Options* screen, click **Next**.

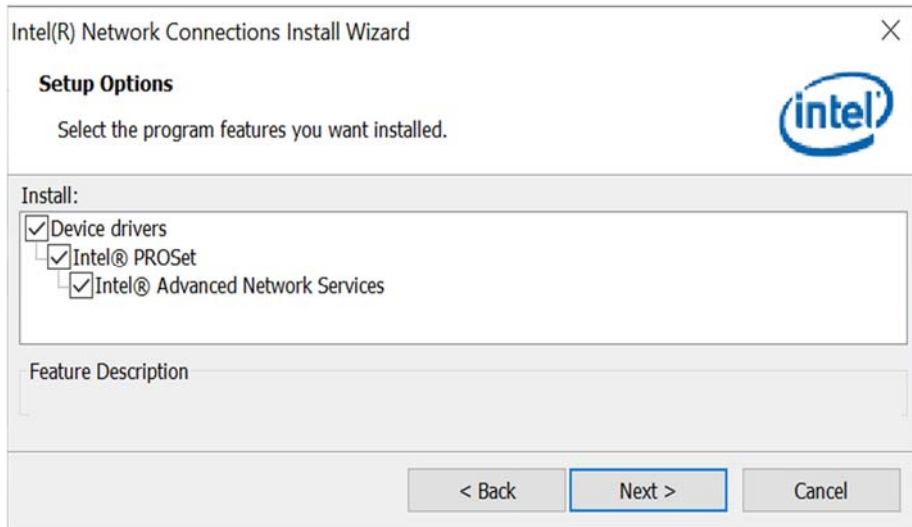

7. Click **install** to begin the installation.

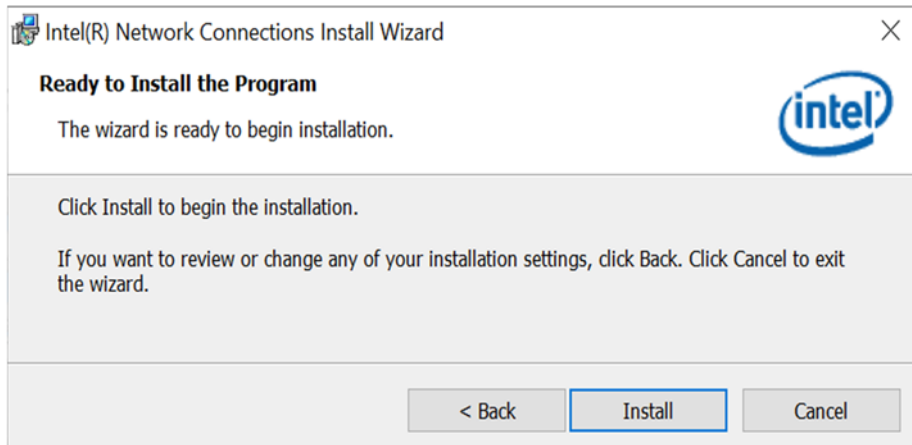

8. Click **Finish** when Install wizard has completed.

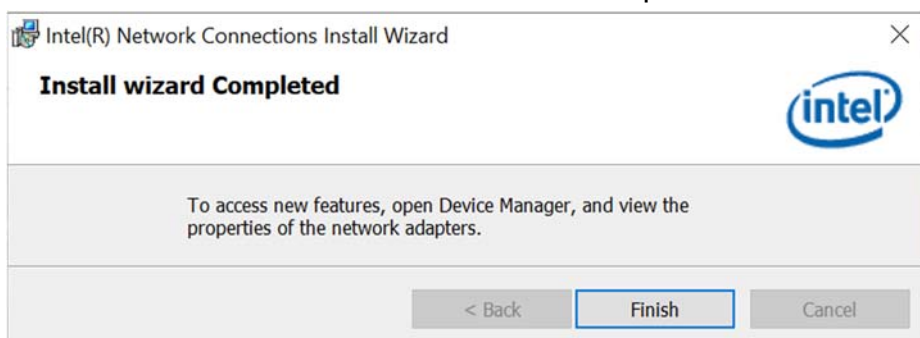

## Chapter 4

# BIOS Setup

This chapter describes the different settings available in the AMI BIOS. The topics covered in this chapter are as follows:

- Main Settings
- Advanced Settings
- Chipset Settings
- Security Settings
- Boot Settings
- Save & Exit

## 4.1 Introduction

The BIOS (Basic Input/Output System) installed in the ROM of the system supports Intel® processors. The BIOS provides critical low-level support for standard devices such as disk drives, serial ports and parallel ports. It also provides password protection as well as special support for detailed fine-tuning of the chipset controlling the entire system.

## 4.2 BIOS Setup

The BIOS provides a Setup utility program for specifying the system configurations and settings. The BIOS ROM of the system stores the Setup utility. When you turn on the computer, the BIOS is immediately activated. Press the <Del> key immediately allows you to enter the Setup utility. If you are a little bit late pressing the <Del> key, POST (Power On Self Test) will continue with its test routines, thus preventing you from invoking the Setup.

If you still need to enter Setup, restart the system by pressing the "Reset" button or simultaneously pressing the <Ctrl>, <Alt> and <Delete> keys. You can also restart by turning the system Off and back On again.

The following message will appear on the screen:

```
Press <DEL> to Enter Setup
```

In general, press the arrow keys to highlight items, <Enter> to select, the <PgUp> and <PgDn> keys to change entries, <F1> for help, and <Esc> to quit.

When you enter the BIOS Setup utility, the *Main Menu* screen will appear on the screen. The Main Menu allows you to select from various setup functions and exit choices.

---

**Warning:** It is strongly recommended that you avoid making any changes to the chipset defaults.

These defaults have been carefully chosen by both AMI and the system manufacturer to provide the absolute maximum performance and reliability. Changing the defaults could make the system unstable and crash in some cases.

---

### 4.3 Main Settings



BIOS Setting	Description
System Date	Sets the date. Use the <Tab> key to switch between the data elements.
System Time	Set the time. Use the <Tab> key to switch between the data elements.

### 4.4 Advanced Settings

This section allows the configuration of the system and the selection of the system features according to your preference.

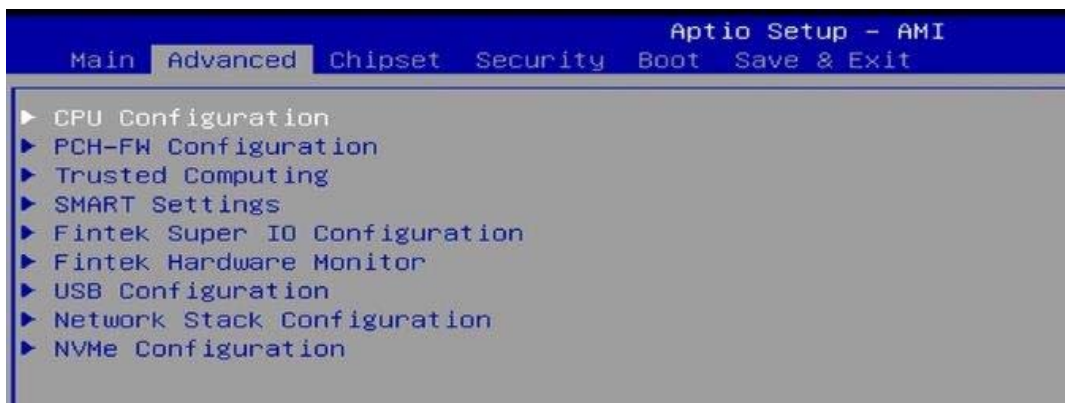

### 4.4.1 CPU Configuration

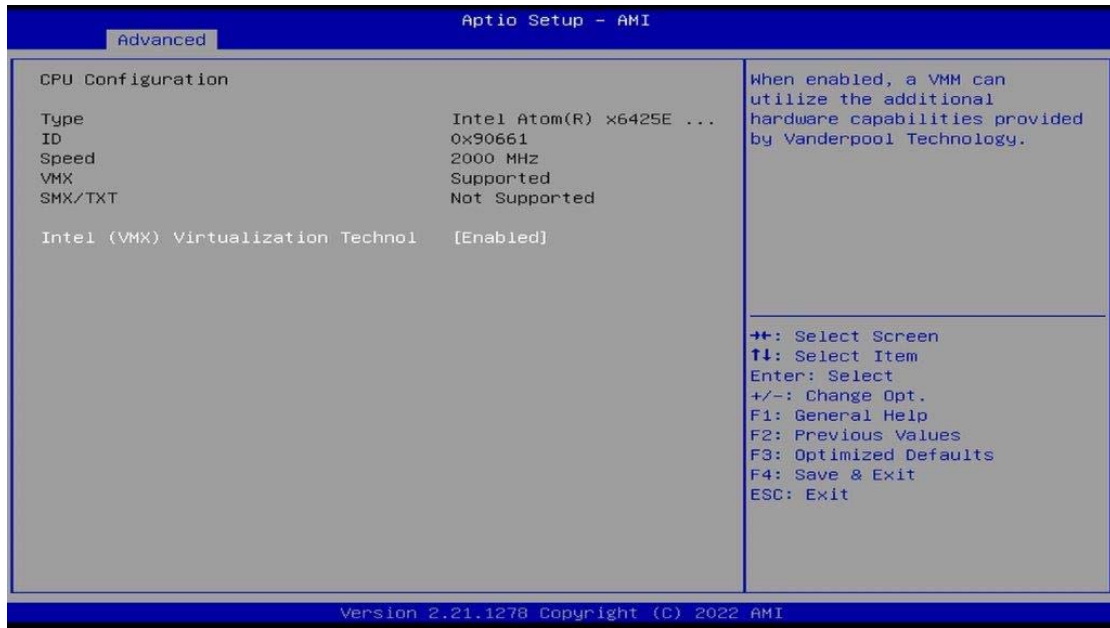

BIOS Setting	Description
Intel (VMX) Virtualization Technology	When enabled, a VMM can utilize the additional hardware capabilities provided by Vanderpool Technology.



## 4.4.2 PCH-FW Configuration

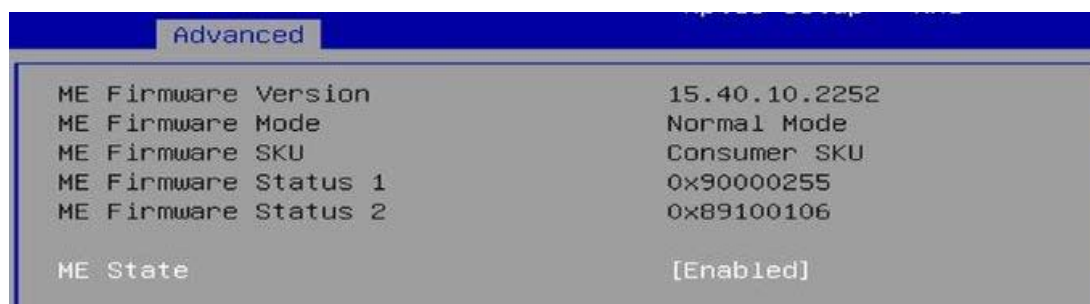

BIOS Setting	Description
ME State	When disabled, ME will be put into ME Temporarily Disabled Mode.
AMT BIOS Features	When disabled, AMT BIOS Features are no longer supported and user is no longer able to access MEBx Setup. Note: This option does not disable Manageability Features in FW.

### 4.4.3 Trusted Computing

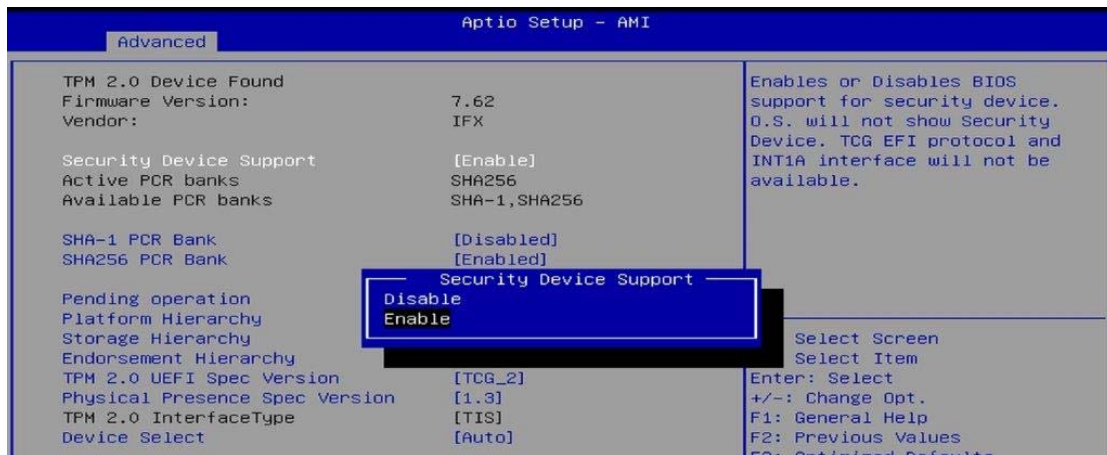

BIOS Setting	Description
Security Device Support	Option: Enable / Disable. OS will not show security device. TCG EFI protocol and INTIA interface will not be available.
SHA-1 PCR Bank	Enables / Disables SHA256 PCR Bank.
SHA256 PCR Bank	Enables / Disables SHA-1 PCR Bank.
Pending operation	Schedule an operation for the security device. Note: Your computer will reboot during restart in order to change state of security device.
Platform Hierarchy	Enables / Disables platform hierarchy.
Storage Hierarchy	Enables / Disables storage hierarchy.
Endorsement Hierarchy	Enables / Disables endorsement hierarchy.
TPM2.0 UEFI Spec Version	Selects the supported TCG version based on OS. <ul style="list-style-type: none"> <li>• <b>TCG_1_2</b>: supports Windows 8 /10.</li> <li>• <b>TCG_2</b>: supports new TCG2 protocol and event format for Windows 10 or later.</li> </ul>
Physical Presence Spec Version	Selects to show the PPI Spec Version (1.2 or 1.3) that the OS supports. <b>Note:</b> Some HCK tests might not support 1.3.
Device Select	<b>TPM 1.2</b> will restrict support to TPM 1.2 devices only. <b>TPM 2.0</b> will restrict support to TPM 2.0 devices only. <b>Auto</b> will support both with the default being set to TPM 2.0 deices if not found, and TPM 1.2 device will be enumerated.

#### 4.4.4 SMART Settings

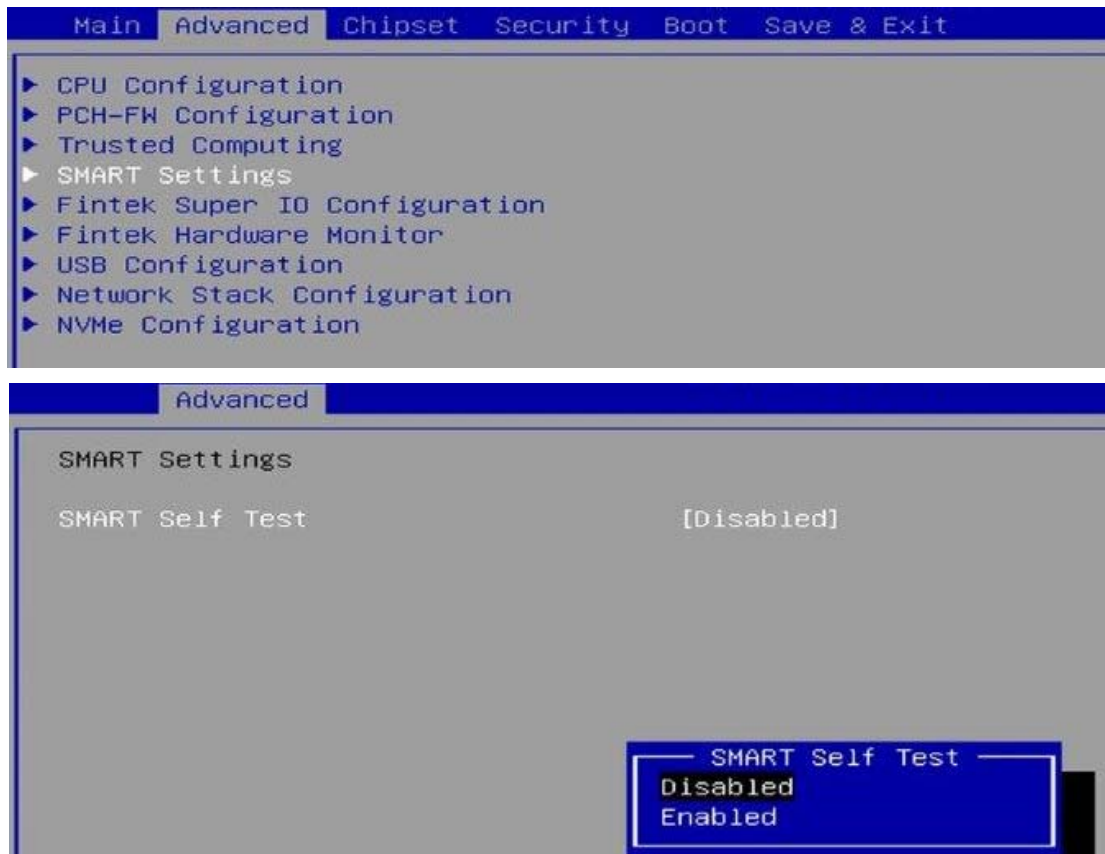

BIOS Setting	Description
SMART Self Test	Run SMART Self Test on all HDDS during POST.

### 4.4.5 Fintek Super IO Configuration



BIOS Setting	Description
Power Failure	Options: Always on, Always off
Serial Port 1 Configuration	Sets parameters of Serial Port 1 (COMA).
Serial Port	Enable / Disable the serial port.
Change Settings	Select an optimal setting for the Super IO device. Options are: IO=3F8h; IRQ=4; IO=3F8h; IRQ=3,4,5,6,7,9,10,11,12; IO=2F8h; IRQ=3,4,5,6,7,9,10,11,12; IO=3E8h; IRQ=3,4,5,6,7,9,10,11,12; IO=2E8h; IRQ=3,4,5,6,7,9,10,11,12;
Device Mode	Change the Serial Port mode. Options are: RS232 RS485 TX Low Active RS485 with Termination TX Low Active RS422 RS422 with Termination
Serial Port 2 Configuration	Sets parameters of Serial Port 2 (COMB).
Serial Port	Enable / Disable the serial port.
Change Settings	Select an optimal setting for the Super IO device. Options are: IO=3F8h; IRQ=4; IO=3F8h; IRQ=3,4,5,6,7,9,10,11,12; IO=2F8h; IRQ=3,4,5,6,7,9,10,11,12; IO=3E8h; IRQ=3,4,5,6,7,9,10,11,12; IO=2E8h; IRQ=3,4,5,6,7,9,10,11,12;

Advanced

Serial Port 1 Configuration

Serial Port [Enabled]  
 Device Settings ID=3F8h; IRQ=4;

Change Settings [Auto]  
 Device Mode [RS232]

Enable or Disable Serial Port (COM)

Serial Port  
 Disabled  
 Enabled

⇄: Select Screen

Advanced

Serial Port 1 Configuration

Serial Port [Enabled]  
 Device Settings ID=3F8h; IRQ=4;

Change Settings [Auto]  
 Device Mode [RS232]

Select an optimal settings for Super I/O Device

Change Settings  
 Auto  
 IO=3F8h; IRQ=4;  
 IO=3F8h; IRQ=3,4,5,6,7,9,10,11,12;  
 IO=2F8h; IRQ=3,4,5,6,7,9,10,11,12;  
 IO=3E8h; IRQ=3,4,5,6,7,9,10,11,12;  
 IO=2E8h; IRQ=3,4,5,6,7,9,10,11,12;

Select Screen  
 Select Item  
 n: Select

Advanced

Serial Port 1 Configuration

Serial Port [Enabled]  
 Device Settings ID=3F8h; IRQ=4;

Change Settings [Auto]  
 Device Mode [RS232]

Change the Serial Port mode.

Device Mode  
 RS232  
 RS485 TX Low Active  
 RS485 with Termination TX Low Active  
 RS422  
 RS422 with Termination

Select Screen  
 Select Item  
 n: Select

Advanced

Serial Port 2 Configuration

Serial Port [Enabled]  
 Device Settings ID=2F8h; IRQ=3;

Change Settings [Auto]

Select an optimal settings for Super I/O Device

Change Settings  
 Auto  
 IO=2F8h; IRQ=3;  
 IO=3F8h; IRQ=3,4,5,6,7,9,10,11,12;  
 IO=2F8h; IRQ=3,4,5,6,7,9,10,11,12;  
 IO=3E8h; IRQ=3,4,5,6,7,9,10,11,12;  
 IO=2E8h; IRQ=3,4,5,6,7,9,10,11,12;

Select Screen  
 Select Item  
 n: Select

### 4.4.6 Fintek Hardware Monitor

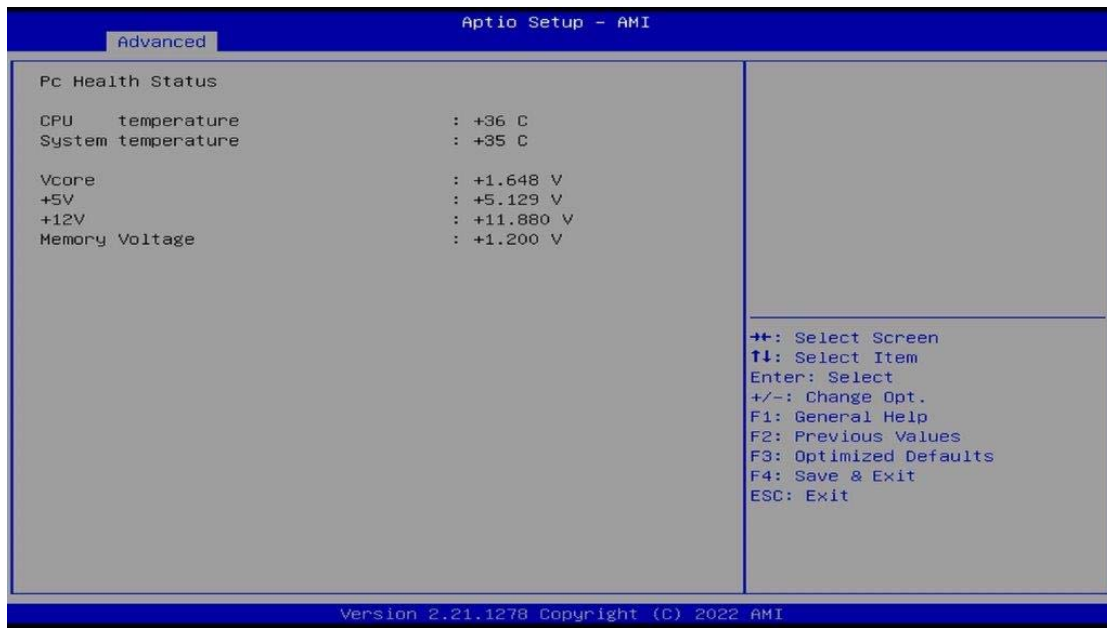

BIOS Setting	Description
Temperatures / Voltages	These fields are the parameters of the hardware monitoring function feature of the motherboard. The values are read-only values as monitored by the system and show the PC health status.

### 4.4.7 USB Configuration

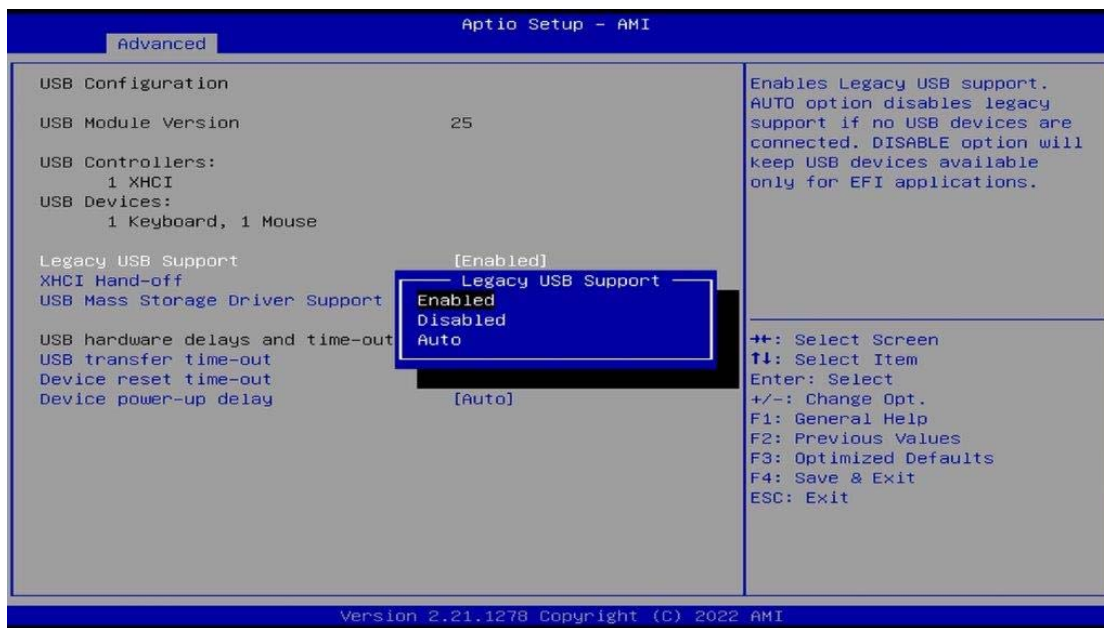

BIOS Setting	Description
Legacy USB Support	<ul style="list-style-type: none"> <li>• <b>Enable:</b> Enables Legacy USB Support.</li> <li>• <b>Auto:</b> Disables legacy support if no USB devices are connected.</li> <li>• <b>Disable:</b> Keeps USB devices available only for EFI applications.</li> </ul>
XHCI Hand-off	This is a workaround for OSes without XHCI hand-off support. The XHCI ownership change should be claimed by XHCI driver.
USB Mass Storage Driver Support	Enables / Disables the support for USB mass storage driver.
USB Transfer time-out	The time-out value for Control, Bulk, and Interrupt transfers.
Device reset time-out	Seconds of delaying execution of start unit command to USB mass storage device.
Device power-up delay	The maximum time the device will take before it properly reports itself to the Host Controller. "Auto" uses default value for a Root port it is 100ms. But for a Hub port, the delay is taken from Hub descriptor.





### 4.4.8 Network Stack Configuration

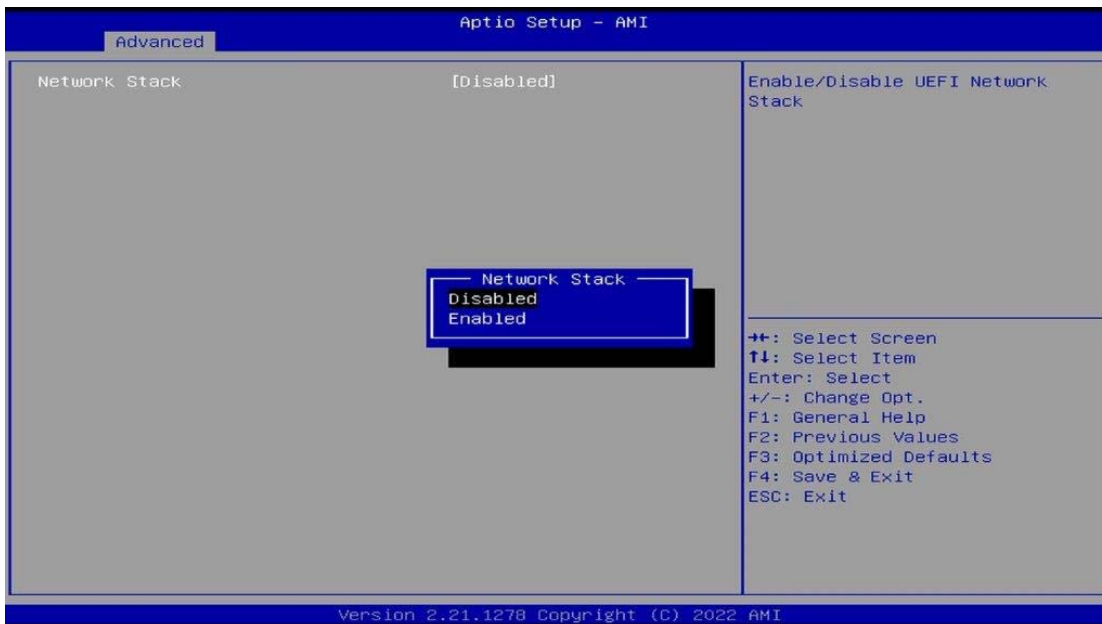

BIOS Setting	Description
Network Stack	Enables / Disables UEFI Network Stack.

### 4.4.9 NVMe Configuration



## 4.5 Chipset Settings

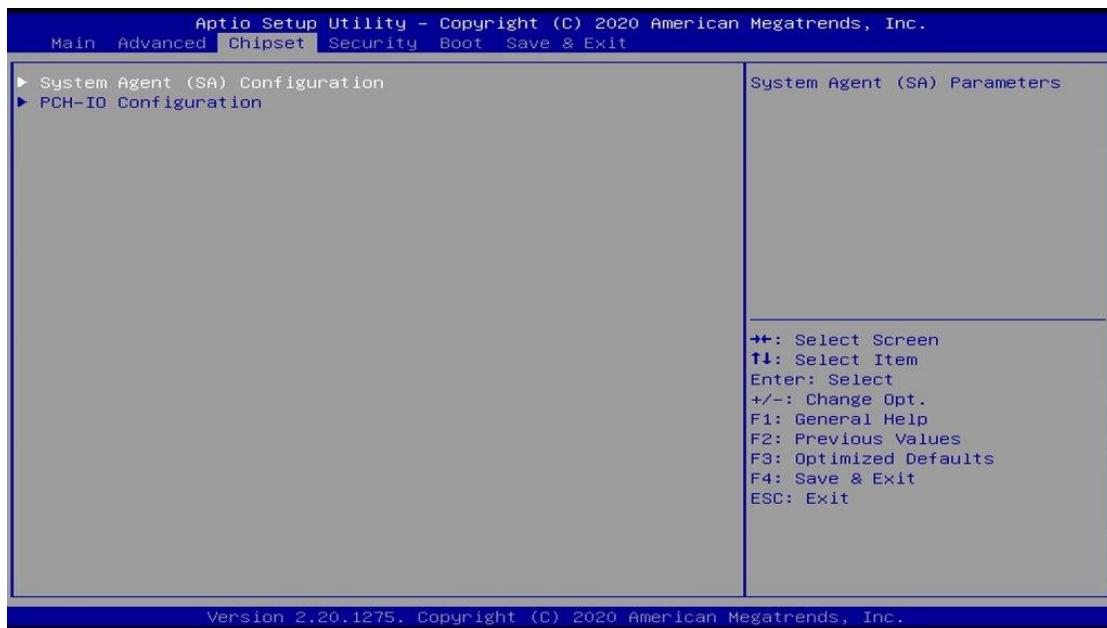

BIOS Setting	Description
System Agent (SA) Configuration	System Agent (SA) parameters
PCH-IO Configuration	PCH parameters

### 4.5.1 System Agent (SA) Configuration



BIOS Setting	Description
Graphics Configuration	Configures the graphics settings.
VT-d	Checks if VT-d function on MCH is supported.

### 4.5.1.1. Graphics Configuration



BIOS Setting	Description
Primary Display	Select which of IGFX/PEG/PCI Graphics device should be primary display or select SG for switchable Gfx. Options: Auto, IGFX, PEG, PCI, SG
Select PCIE Card	Selects the card used on the platform. <b>Auto</b> skips GPIO based Power Enable to dGPU. <b>E1k Creek 4:</b> DGPU Power Enable = Active Low. <b>PEG Eva1:</b> DGPU Power Enable = Active High.
Internal Graphics	Keep IGFX enabled based on the setup options. Options: Auto, Disabled, Enabled
GTT Size	Sets the GTT size as 2 MB, 4 MB, or 8 MB.
Aperture Size	Sets the aperture size as 128 MB, 256 MB, 512 MB, 1024 MB or 2048 MB. <b>Note:</b> Above 4GB MMIO BIOS assignment is automatically enabled when selecting 2048 MB aperture. To use this feature, disable CSM support.

### 4.5.2 PCH-IO Configuration



BIOS Setting	Description
SATA and RST Configuration	Configures SATA devices.
PCH LAN Controller	Enables / Disables the onboard NIC.
Wake on LAN Enable	Enables / Disables the integrated LAN to wake up the system.
PS_ON Enable	Enables / Disables PS_ON support a new C10 state from the CPU on desktop SKUs that enables a lower power target that will be required by the California Energy commission (CEC).

**4.5.2.1. SATA and RST Configuration:**

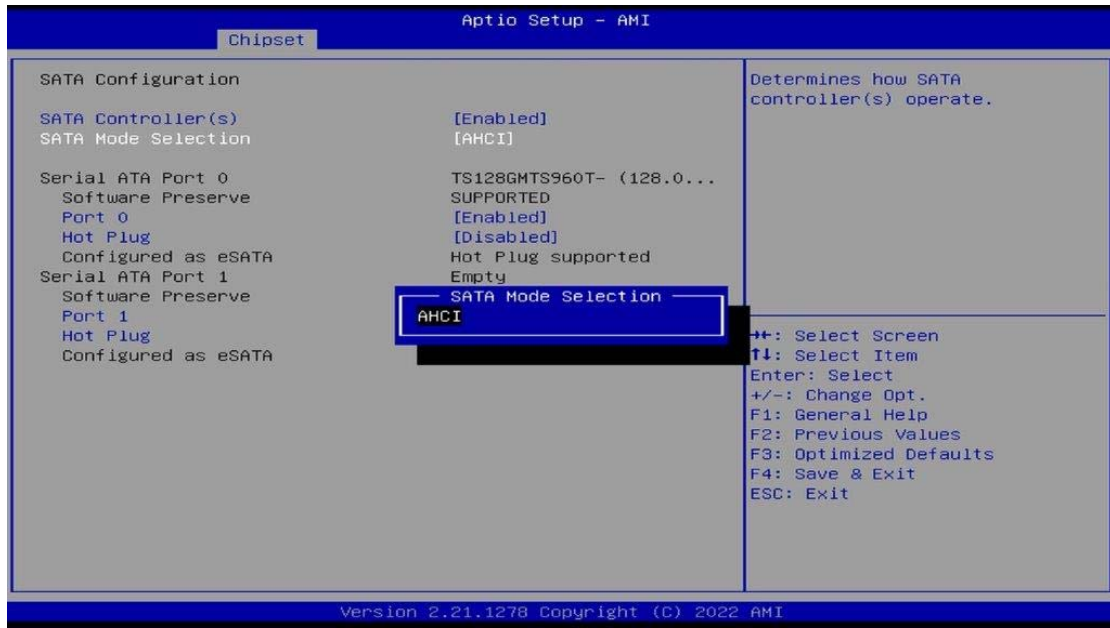

BIOS Setting	Description
SATA Controller(s)	Enables / Disables the SATA device.
SATA Mode Selection	Determines how SATA controller(s) operate. Options: AHCI / Intel RST Premium
Serial ATA Ports	Enables / Disables serial ports.
SATA Ports Hot Plug	Enables / Disables SATA Ports HotPlug.

## 4.6 Security Settings

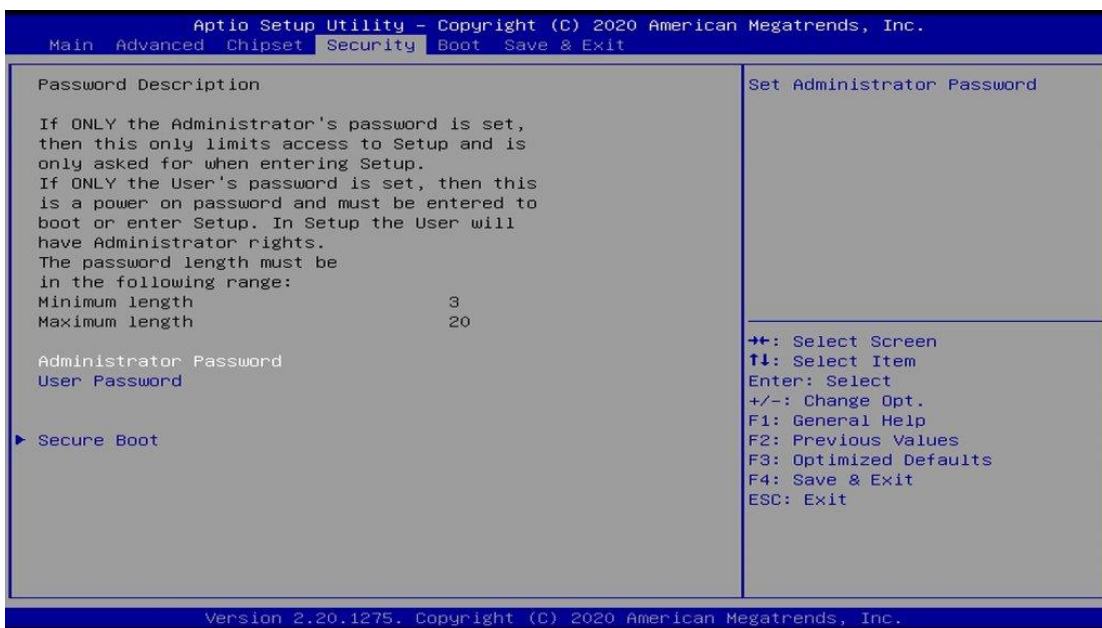

BIOS Setting	Description
Administrator Password	Sets an administrator password for the setup utility.
User Password	Sets a user password.
Secure Boot	Configures Secure Boot.

**4.6.1 Secure Boot**



BIOS Setting	Description
Secure Boot	Secure Boot feature is Active if Secure Boot is enabled. Platform Key (PK) Is enrolled and the system is in User mode. The mode change requires platform reset.
Secure Boot Mode	Secure Boot mode options: Standard or Custom. In Custom mode, Secure Boot Policy variables can be configured by a physically present user without full authentication.
Restore Factory Keys	Forces system to user mode. Install factory default Secure Boot key databases.
Key Management	Enables expert users to modify Secure Boot Policy variables without full authentication.

## 4.7 Boot Settings

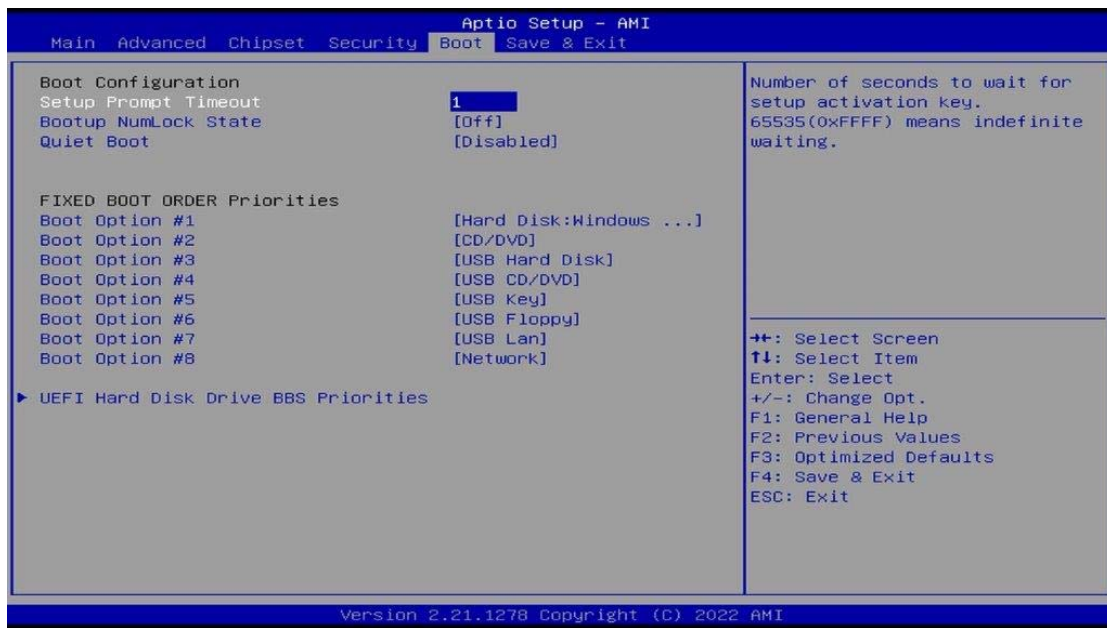

BIOS Setting	Description
Setup Prompt Timeout	Number of seconds to wait for setup activation key. 65535(0xFFFF) means indefinite waiting.
Bootup NumLock State	Selects the keyboard NumLock state.
Quiet Boot	Enables / Disables Quiet Boot option.
Boot mode select	Selects a Boot mode, Legacy / UEFI.
Boot Option Priorities	Sets the system boot order.

## 4.8 Save & Exit Settings

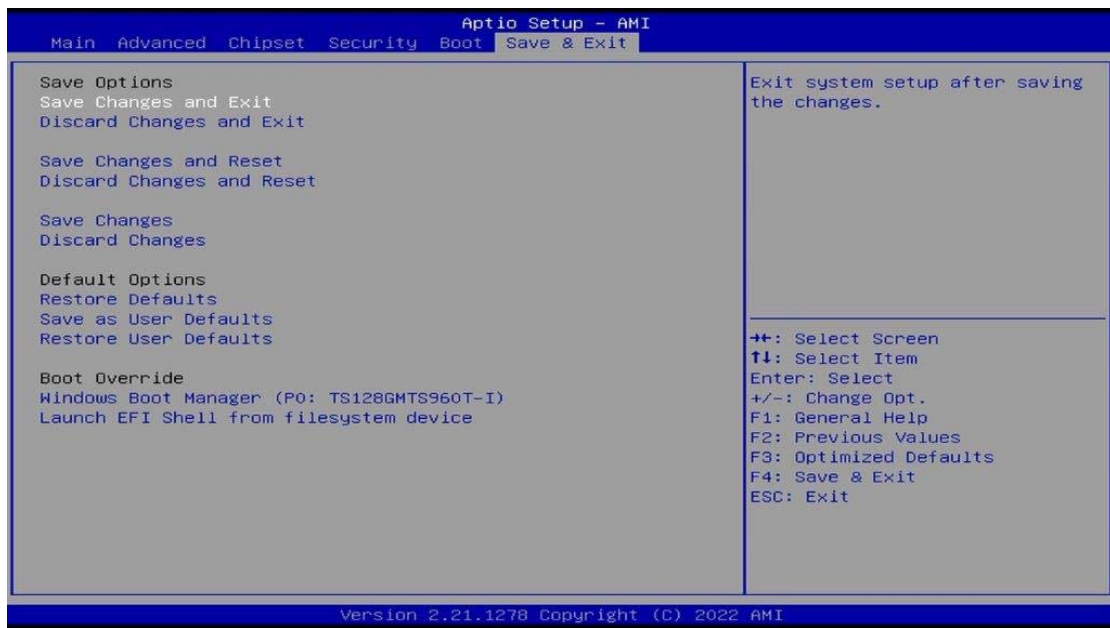

BIOS Setting	Description
Save Changes and Exit	Exits system setup after saving the changes.
Discard Changes and Exit	Exits system setup without saving any changes.
Save Changes and Reset	Resets the system after saving the changes.
Discard Changes and Reset	Resets system setup without saving any changes.
Save Changes	Saves changes done so far to any of the setup options.
Discard Changes	Discards changes done so far to any of the setup options.
Restore Defaults	Restores / Loads defaults values for all the setup options.
Save as User Defaults	Saves the changes done so far as User Defaults.
Restore User Defaults	Restores the user defaults to all the setup options.



## Appendix

This section provides the mapping addresses of peripheral devices and the sample code of watchdog timer configuration.

- I/O Port Address Map
- Interrupt Request Lines (IRQ)

## A. I/O Port Address Map

Each peripheral device in the system is assigned a set of I/O port addresses which also becomes the identity of the device. The following table lists the I/O port addresses used.

Address	Device Description
0x00000A00-0x00000A0F	Motherboard resources
0x00000A10-0x00000A1F	Motherboard resources
0x00000A20-0x00000A2F	Motherboard resources
0x0000002E-0x0000002F	Motherboard resources
0x0000004E-0x0000004F	Motherboard resources
0x00000061-0x00000061	Motherboard resources
0x00000063-0x00000063	Motherboard resources
0x00000065-0x00000065	Motherboard resources
0x00000067-0x00000067	Motherboard resources
0x00000070-0x00000070	Motherboard resources
0x00000080-0x00000080	Motherboard resources
0x00000092-0x00000092	Motherboard resources
0x000000B2-0x000000B3	Motherboard resources
0x00000680-0x0000069F	Motherboard resources
0x0000164E-0x0000164F	Motherboard resources
0x00003000-0x0000303F	Intel(R) UHD Graphics
0x000003F8-0x000003FF	Communications Port (COM1)
0x000002F8-0x000002FF	Communications Port (COM2)
0x00001800-0x000018FE	Motherboard resources
0x00003090-0x00003097	Standard SATA AHCI Controller
0x00003080-0x00003083	Standard SATA AHCI Controller
0x00003060-0x0000307F	Standard SATA AHCI Controller
0x00000020-0x00000021	Programmable interrupt controller
0x00000024-0x00000025	Programmable interrupt controller
0x00000028-0x00000029	Programmable interrupt controller
0x0000002C-0x0000002D	Programmable interrupt controller
0x00000030-0x00000031	Programmable interrupt controller
0x00000034-0x00000035	Programmable interrupt controller

<b>Address</b>	<b>Device Description</b>
0x00000038-0x00000039	Programmable interrupt controller
0x0000003C-0x0000003D	Programmable interrupt controller
0x000000A0-0x000000A1	Programmable interrupt controller
0x000000A4-0x000000A5	Programmable interrupt controller
0x000000A8-0x000000A9	Programmable interrupt controller
0x000000AC-0x000000AD	Programmable interrupt controller
0x000000B0-0x000000B1	Programmable interrupt controller
0x000000B4-0x000000B5	Programmable interrupt controller
0x000000B8-0x000000B9	Programmable interrupt controller
0x000000BC-0x000000BD	Programmable interrupt controller
0x000004D0-0x000004D1	Programmable interrupt controller
0x00001854-0x00001857	Motherboard resources
0x00000000-0x00000CF7	PCI Express Root Complex
0x00000D00-0x0000FFFF	PCI Express Root Complex
0x0000EFA0-0x0000EFBF	Intel(R) SMBus Controller - 4B23
0x00002000-0x000020FE	Motherboard resources
0x00000040-0x00000043	System timer
0x00000050-0x00000053	System timer

## B. Interrupt Request Lines (IRQ)

Peripheral devices use interrupt request lines to notify CPU for the service required. The following table shows the IRQ used by the devices on board.

Level	Function
IRQ 16	High Definition Audio Controller
IRQ 4294967292	Intel(R) UHD Graphics
IRQ 4	Communications Port (COM1)
IRQ 3	Communications Port (COM2)
IRQ 4294967294	Standard SATA AHCI Controller
IRQ 4294967293	Intel(R) USB 3.10 eXtensible Host Controller - 1.20 (Microsoft)
IRQ 55 ~ 204	Microsoft ACPI-Compliant System
IRQ 256 ~ 511	Microsoft ACPI-Compliant System
IRQ 4294967291	Intel(R) Wireless-AC 9260
IRQ 4294967290	Intel(R) Wireless-AC 9260
IRQ 4294967284	Sierra Wireless EM9190 PCIe Device
IRQ 4294967283	Intel(R) Management Engine Interface #1
IRQ 4294967289	Intel(R) Ethernet Controller (3) I225-IT
IRQ 4294967288	Intel(R) Ethernet Controller (3) I225-IT
IRQ 4294967287	Intel(R) Ethernet Controller (3) I225-IT
IRQ 4294967286	Intel(R) Ethernet Controller (3) I225-IT
IRQ 4294967285	Intel(R) Ethernet Controller (3) I225-IT
IRQ 0	System timer