

EMS-TGL

Intel 11th Gen Intel®Core™ Processor i7/i5/i3
Fanless Rugged Embedded System

Quick Reference Guide

5th Ed –18 April 2023

Copyright Notice

Copyright © 2023 Avalue Technology Inc., ALL RIGHTS RESERVED.

FCC Statement



THIS DEVICE COMPLIES WITH PART 15 FCC RULES. OPERATION IS SUBJECT TO THE FOLLOWING TWO CONDITIONS:

(1) THIS DEVICE MAY NOT CAUSE HARMFUL INTERFERENCE.

(2) THIS DEVICE MUST ACCEPT ANY INTERFERENCE RECEIVED INCLUDING INTERFERENCE THAT MAY CAUSE UNDESIRE OPERATION.

THIS EQUIPMENT HAS BEEN TESTED AND FOUND TO COMPLY WITH THE LIMITS FOR A CLASS "A" DIGITAL DEVICE, PURSUANT TO PART 15 OF THE FCC RULES.

THESE LIMITS ARE DESIGNED TO PROVIDE REASONABLE PROTECTION AGAINST HARMFUL INTERFERENCE WHEN THE EQUIPMENT IS OPERATED IN A COMMERCIAL ENVIRONMENT. THIS EQUIPMENT GENERATES, USES, AND CAN RADIATE RADIO FREQUENCY ENERGY AND, IF NOT INSTALLED AND USED IN ACCORDANCE WITH THE INSTRUCTION MANUAL, MAY CAUSE HARMFUL INTERFERENCE TO RADIO COMMUNICATIONS.

OPERATION OF THIS EQUIPMENT IN A RESIDENTIAL AREA IS LIKELY TO CAUSE HARMFUL INTERFERENCE IN WHICH CASE THE USER WILL BE REQUIRED TO CORRECT THE INTERFERENCE AT HIS OWN EXPENSE.

A Message to the Customer

Avalue Customer Services

Each and every Avalue's product is built to the most exacting specifications to ensure reliable performance in the harsh and demanding conditions typical of industrial environments. Whether your new Avalue device is destined for the laboratory or the factory floor, you can be assured that your product will provide the reliability and ease of operation for which the name Avalue has come to be known.

Your satisfaction is our primary concern. Here is a guide to Avalue's customer services. To ensure you get the full benefit of our services, please follow the instructions below carefully.

Technical Support

We want you to get the maximum performance from your products. So if you run into technical difficulties, we are here to help. For the most frequently asked questions, you can easily find answers in your product documentation. These answers are normally a lot more detailed than the ones we can give over the phone. So please consult the user's manual first.

To receive the latest version of the user's manual; please visit our Web site at:

<http://www.avalue.com.tw/>

Content

1. Getting Started	7
1.1 Safety Precautions	7
1.2 Packing List	7
1.3 System Specifications	8
1.4 System Overview.....	14
1.4.1 Front View	14
1.4.2 Rear View.....	14
1.5 System Dimensions.....	22
1.5.1 EMS-TGL Front & Top view	22
1.5.2 EMS-TGL-6 COM/EMS-TGL-4 COM Isolation Front & Top view	23
1.5.3 EMS-TGL-6 LAN Bypass/EMS-TGL-6 LAN Normal/EMS-TGL-PSEBF Front & Top view	24
1.5.4 EMS-TGL-PSEBT Front & Top view.....	25
1.5.5 EMS-TGL-HDMI Front & Top view	26
1.5.6 EMS-TGL-DVI Front & Top view.....	27
1.5.7 EMS-TGL-USB Front & Top view	28
2. Hardware Configuration	29
2.1 EMS-TGL connector mapping	30
2.1.1 Serial port connector 1/2 (COM1/2).....	30
2.1.2 Serial port 3/4/5/6 connector (COM3/4/5/6).....	31
2.1.3 General purpose I/O connector (GPIO)	31
2.1.4 DC power-in connector (DC-in).....	31
2.2 EBM-TGLS, AUX-M01, IET-6 LAN Bypass, IET-6 LAN Normal, IET-PSEBF (4 port af), IET-PSEBT (2 port at), AUX-M07, EBM-BYTS DB-A, EBM-CDVS DB-A and EBM-BYTS DB-E Overviews.....	32
2.2.1 EBM-TGLS.....	32
2.2.2 AUX-M01.....	33
2.2.3 IET-6 LAN Bypass	33
2.2.4 IET-6 LAN Normal.....	34
2.2.5 IET-PSEBF (4 port af).....	34
2.2.6 IET-PSEBT (2 port at).....	35
2.2.7 AUX-M07.....	35
2.2.8 EBM-BYTS DB-A	36
2.2.9 EBM-CDVS DB-A	36
2.2.10 EBM-BYTS DB-E.....	37
2.3 EBM-TGLS Jumper & Connector list.....	38

EMS-TGL

2.4	EBM-TGLS Jumpers & Connectors settings	40
2.4.1	Multi-function select (SW1)	40
2.4.2	Serial port 1/2 pin 9 signal select (JRI1/2)	40
2.4.3	Serial port 1/2 RS-232/422/485 mode select (JCOM_SEL1/2)	41
2.4.4	Clear CMOS (JBAT1)	41
2.4.5	LPC port connector (JLPC1).....	42
2.4.6	SPI connector (JSPI1)	42
2.4.7	Front Panel Connector (JFP1).....	43
2.4.8	DC Output connector (DCOUT1).....	43
2.4.9	DC Input connector (JVIN1).....	44
2.4.10	EC Debug connector (JEC_ROM1).....	44
2.4.11	On-board header for USB2.0 (JUSB1).....	45
2.4.12	Power on/off connector (PWRBTN1)	45
2.5	EBM-TGLS, AUX-M01, IET-6 LAN Bypass, IET-6 LAN Normal, IET-PSEBF (4 port af), IET-PSEBT (2 port at), AUX-M07, EBM-BYTS DB-A, EBM-CDVS DB-A and EBM-BYTS DB-E Jumper & Connector list	46
2.6	AUX-M01 Jumpers & Connectors settings	49
2.6.1	COM 3/4/5/6 pin 9 signal select (JRI3/4/5/6)	49
2.6.2	USB connector (USB3).....	49
2.6.3	USB connector (JUSB3)	50
2.6.4	SMBUS of TCA9555 address setting (PJP1)	50
2.7	IET-6 LAN Normal Connectors settings.....	51
2.7.1	USB connector 3 (USB3)	51
2.7.2	Power connector (PWR1)	51
2.8	IET-PSEBF (4 port af) Jumpers & Connectors settings.....	52
2.8.1	USB connector 3 (USB3)	52
2.8.2	Power connector (PWR1)	52
2.9	IET-PSEBT (2 port at) Jumpers & Connectors settings.....	53
2.9.1	USB connector 3 (USB3)	53
2.9.2	Power connector (PWR1)	53
2.10	AUX-M07 Connector settings	54
2.10.1	SMBUS of TCA9555 address setting (SJP2).....	54
2.11	EBM-BYTS DB-A Jumpers & Connectors settings.....	55
2.11.1	COM 3/4 pin 9 signal select (OJRI3/4).....	55
2.11.2	Serial port 1/ 2 – RS485 mode select (OJP485)	55
2.11.3	SMBUS of TCA9555 address setting (OJP1).....	56
2.12	EBM-CDVS DB-A Connector settings	56
2.12.1	Front Panel Connector 1 (CN1).....	56
2.13	Installing Hard Disk & Memory (EMS-TGL)	57
3	BIOS Setup	58

3.1	Introduction.....	59
3.2	Starting Setup.....	59
3.3	Using Setup.....	60
3.4	Getting Help.....	61
3.5	In Case of Problems.....	61
3.6	BIOS setup.....	62
3.6.1	Main Menu.....	62
3.6.1.1	System Language.....	63
3.6.1.2	System Date.....	63
3.6.1.3	System Time.....	63
3.6.2	Advanced Menu.....	63
3.6.2.1	CPU Configuration.....	64
3.6.2.2	Power & Performance.....	65
3.6.2.2.1	CPU-Power Management Control.....	65
3.6.2.3	PCH-FW Configuration.....	66
3.6.2.3.1	Firmware Update Configuration.....	66
3.6.2.4	Trusted Computing.....	67
3.6.2.5	APCI Settings.....	67
3.6.2.6	IT8528 Super IO Configuration.....	68
3.6.2.6.1	Serial Port 1 Configuration.....	69
3.6.2.6.2	Serial Port 2 Configuration.....	69
3.6.2.6.3	Serial Port 3 Configuration.....	70
3.6.2.6.4	Serial Port 4 Configuration.....	71
3.6.2.6.5	Serial Port 5 Configuration.....	72
3.6.2.6.6	Serial Port 6 Configuration.....	73
3.6.2.7	H/W Monitor.....	74
3.6.2.8	S5 RTC Wake Settings.....	74
3.6.2.9	Serial Port Console Redirection.....	75
3.6.2.9.1	Legacy Console Redirection Settings.....	75
3.6.2.10	USB Configuration.....	76
3.6.2.11	Network Stack Configuration.....	77
3.6.2.12	NVMe Configuration.....	77
3.6.3	Chipset.....	78
3.6.3.1	System Agent (SA) Configuration.....	78
3.6.3.1.1	Memory Configuration.....	79
3.6.3.1.2	Graphics Configuration.....	79
3.6.3.2	PCH-IO Configuration.....	80
3.6.3.2.1	PCI Express Configuration.....	80
3.6.3.2.1.1	PCI Express Root Port 5 (IET).....	81
3.6.3.2.1.2	PCI Express Root Port 6 (IET).....	82

EMS-TGL

3.6.3.2.1.3 PCI Express Root Port 8 (I225)	83
3.6.3.2.1.4 PCI Express Root Port 9 (IET).....	84
3.6.3.2.1.5 PCI Express Root Port 10 (IET).....	85
3.6.3.2.1.6 PCI Express Root Port 11 (M.2 KeyB).....	86
3.6.3.2.1.7 PCI Express Root Port 12 (M.2 KeyE).....	87
3.6.3.2.2 SATA And RST Configuration	88
3.6.3.2.3 HD Audio Configuration	88
3.6.3.2 Board & Panel Configuration.....	89
3.6.4 Security	90
3.6.4.1 Secure Boot menu.....	91
3.6.5 Boot.....	92
3.6.6 Save and exit	93
3.6.6.1 Save Changes and Reset	93
3.6.6.2 Discard Changes and Reset	93
3.6.6.3 Restore Defaults.....	94
3.6.6.4 Launch EFI Shell from filesystem device	94
4. Drivers Installation.....	95
4.1 Install Chipset Driver	96
4.2 Install ME Driver	97
4.3 Install VGA Driver	98
4.4 Install Audio Driver (For Realtek ALC888S)	99
4.5 Install SerialIO Driver.....	100
4.6 Install Ethernet Driver	101

1. Getting Started

1.1 Safety Precautions

Warning!



Always completely disconnect the power cord from your chassis whenever you work with the hardware. Do not make connections while the power is on. Sensitive electronic components can be damaged by sudden power surges. Only experienced electronics personnel should open the PC chassis.

Caution!



Always ground yourself to remove any static charge before touching the CPU card. Modern electronic devices are very sensitive to static electric charges. As a safety precaution, use a grounding wrist strap at all times. Place all electronic components in a static-dissipative surface or static-shielded bag when they are not in the chassis.

1.2 Packing List

- 1 x EMS-TGL 11th Gen Intel®Core™ Processor i7/i5/i3 Fanless Rugged Embedded System
- 1 x Terminal block to lockable DC Jack cable
- 1 x DP to VGA Converter
- 1 x Screw driver for chassis
- 1 x Wire tie for HDMI
- 1 x 60W/120W adapter (optional)
- 1 x Power cord (optional)
- 1 x Thermal pad for M.2 NVMe SSD



If any of the above items is damaged or missing, contact your retailer.

1.3 System Specifications

System	
Board	<ul style="list-style-type: none"> EBM-TGLS (EMS-TGL) <p><u>With IET Extension Board</u></p> <ul style="list-style-type: none"> EBM-TGLS +AUX-M01 (EMS-TGL-6 COM) EBM-TGLS +IET-BYPASS (EMS-TGL-6 LAN Bypass) EBM-TGLS +IET-Normal LAN (EMS-TGL-6 LAN Normal) EBM-TGLS +IET-PSEBF (EMS-TGL-PSEBF), support 4 port IEEE 802.af EBM-TGLS +IET-PSEBT (EMS-TGL-PSEBT), support 2 port IEEE 802.at EBM-TGLS +AUX-M07 (EMS-TGL-4 COM Isolation) EBM-TGLS +EBM-BYTS DB-A (EMS-TGL-HDMI) EBM-TGLS +EBM-CDVS DB-A (EMS-TGL-DVI) EBM-TGLS +EBM-BYTS DB-E (EMS-TGL-USB)
CPU	<ul style="list-style-type: none"> Intel® Core™ i7- 1185GRE (15W, 12M Cache, up to 2.80 GHz), WT Intel® Core™ i5- 1145GRE (15W, 8M Cache, up to 2.60 GHz), WT Intel® Core™ i3- 1115GRE (15W, 6M Cache, up to 3.00 GHz), WT Intel® Core™ i7- 1185G7E (15W, 12M Cache, up to 2.80 GHz), ST Intel® Core™ i5- 1145G7E (15W, 8M Cache, up to 2.60 GHz), ST Intel® Core™ i3- 1115G4E (15W, 6M Cache, up to 3.00 GHz), ST
BIOS	<ul style="list-style-type: none"> AMI uEFI BIOS 256 Mbit SPI Flash ROM
System Chipset	<ul style="list-style-type: none"> SoC
I/O Chip	<ul style="list-style-type: none"> EC ITE IT8528E
System Memory	<ul style="list-style-type: none"> 2 x 260-pin SODIMM socket Max. up to 64GB DDR4 3200 MT/s
Watchdog Timer	<ul style="list-style-type: none"> H/W Reset, 1sec. ~ 65535sec.
Battery	<ul style="list-style-type: none"> Horizontal battery socket Supports wide operating temperature (adjusting according to test result) Supports no RTC battery mode
H/W Status Monitor	<ul style="list-style-type: none"> CPU & system temperature monitoring and Voltages monitoring
Expansion	
Expansion	<ul style="list-style-type: none"> 1 x M.2 Key-B 2242/3042/3052 support SATA3/ PCIeIII x1/ USB3.1 and SIM slot1 1 x M.2 Key-E 2230 for Wi-Fi & BT Module(CNVi) 1 x IET interface (1 x DDI, 2x PCIeIII x2, 3 x USB2.0, 1 x Line-Out(R/L), 1 x SMBus, LPC)
Storage	

<p>Combination</p>	<ul style="list-style-type: none"> • 1 x M.2 Key-M 2242/2280, support PCIe Gen. IV x 4 (NVMe SSD) • 1 x M.2 Key-B 2242, support SATA (share with expansion slot)
<p>Edge I/O</p>	
<p>USB Port</p>	<p>(EMS-TGL)</p> <ul style="list-style-type: none"> • 2 x USB 3.1 Gen.2 (10Gbp/s) • 2 x USB 3.1 Gen.1 (5Gbp/s) via Hub, (w/ USB 2.0) <p>(EMS-TGL-HDMI, EMS-TGL-DVI, EMS-TGL-6COM, EMS-TGL-4COM isolation, EMS-TGL-PSEBF, EMS-TGL-PSEBT, EMS-TGL-6 LAN Bypass, EMS-TGL 6 LAN Normal)</p> <ul style="list-style-type: none"> • 2 x USB 3.1 Gen.2 (10Gbp/s) • 2 x USB 3.1 Gen.1 (5Gbp/s) via Hub, (w/ USB 2.0) • 2 x USB 2.0 <p>(EMS-TGL-USB)</p> <ul style="list-style-type: none"> • 2 x USB 3.1 Gen.2 (10Gbp/s) • 6 x USB 3.1 Gen.1 (5Gbp/s) via Hub, (w/ USB 2.0) • 3 x USB 2.0
<p>Button</p>	<ul style="list-style-type: none"> • 1 x Push Button for Power on/off • 1 x Push Button for Reset • 1 x 2-Pin Terminal Block for wire-control power on/off
<p>SIM slot</p>	<ul style="list-style-type: none"> • 1 x internal SIM slot
<p>LED</p>	<ul style="list-style-type: none"> • 1 x Power LED (Blue) • 1 x Storage LED (Yellow)- M.2 B-key SATA/ M.2 M-key PCIe Storage • 1 x LTE LED (Green)- M.2 B-key PCIe/USB3 • 1 x Wifi LED (Green)- M.2 E key
<p>Serial Port</p>	<p>(EMS-TGL, EMS-TGL-DVI, EMS-TGL-USB, EMS-TGL-PSEBF, EMS-TGL-PSEBT, EMS-TGL-6 LAN Bypass, EMS-TGL 6 LAN Normal)</p> <ul style="list-style-type: none"> • 2 x COM RS232/422/485 (select via BIOS, auto flow control via HW) <p>(EMS-TGL-HDMI)</p> <ul style="list-style-type: none"> • 4 x COM RS232/422/485 (select via BIOS, auto flow control via HW) <p>(EMS-TGL-6COM)</p> <ul style="list-style-type: none"> • 6 x COM RS232/422/485 (select via BIOS, auto flow control via HW) <p>(EMS-TGL-4COM isolation)</p> <ul style="list-style-type: none"> • 6 x COM RS232/422/485 (select via BIOS, auto flow control via HW), COM3 ~ COM6 Supported 2.5kv Isolation.
<p>LAN</p>	<p>(EMS-TGL, EMS-TGL-DVI, EMS-TGL-6COM, EMS-TGL-4 COM isolation, EMS-TGL-USB)</p> <ul style="list-style-type: none"> • 2 x RJ45 <p>(EMS-TGL-HDMI)</p> <ul style="list-style-type: none"> • 4 x RJ45 <p>(EMS-TGL-PSEBT)</p>

EMS-TGL

	<ul style="list-style-type: none"> 4 x RJ45, 2 port Powered LAN support IEEE802.at (EMS-TGL-6 LAN Bypass, EMS-TGL 6 LAN Normal) 6 x RJ45 (EMS-TGL-PSEBF) 6 x RJ45, 4 port Powered LAN support IEEE802.af
Audio	<ul style="list-style-type: none"> 1 x Mic-In, 1 x Line-Out
GPIO	<ul style="list-style-type: none"> 1 x 8-bit GPIO (DB9)
Others	<ul style="list-style-type: none"> 8 x Antenna with dust cover (6 x LTE+GPS / 2 x Wifi)
Display	
Chipset	<ul style="list-style-type: none"> Intel® Iris® Xe Graphics (i7-1185GRE/i5-1145GRE/i7-1185G7E/i5-1145G7E) Intel® UHD Graphics for 11th Gen Intel® Processors (i3-1115GRE/i3-1115G4E)
Display Interface	<p>(EMS-TGL-HDMI, , EMS-TGL-6COM, EMS-TGL-4COM isolation, EMS-TGL-PSEBF, EMS-TGL-PSEBT, EMS-TGL-6 LAN Bypass, EMS-TGL 6 LAN Normal)</p> <ul style="list-style-type: none"> 1 x DP 1.4 (eDP to DP) (DP to VGA converter is the standard accessory, and optional DP to DVI, DP to HDMI converters) 1 x HDMI 2.0b (DDI) (EMS-TGL-DVI) 1 x DP 1.4 (eDP to DP) (DP to VGA converter is the standard accessory, and optional DP to DVI, DP to HDMI converters) 1 x HDMI 2.0b (DDI) 1 x DVI-D (EMS-TGL-HDMI) 1 x DP 1.4 (eDP to DP) (DP to VGA converter is the standard accessory, and optional DP to DVI, DP to HDMI converters) 2 x HDMI 2.0b (DDI)
Resolution	<ul style="list-style-type: none"> DP++ 1.4: 4096x2304 @ 60Hz HDMI 2.0b: Max. resolution 4096x2304 @ 60Hz DVI-D (Dual Link): 2560x1600 @ 60Hz
Multiple Display	<ul style="list-style-type: none"> 2 displays 3 displays (EMS-TGL-DVI, EMS-TGL-HDMI)
Ethernet	
Chipset	<p>Standard Sku:</p> <ul style="list-style-type: none"> 1 x Intel I225-LM, w/ TSN (need additional SW support) 1 x Intel I219-LM, vPro support (only with i5 and i7 CPU)

Ethernet Interface	<ul style="list-style-type: none"> 1 x 10/100/1000/2.5G Base-Tx GbE compatible 1 x 10/100/1000Base-Tx GbE compatible. 																																								
LED Signal	<ul style="list-style-type: none"> 2.5G LAN Port (i225-LM) <table border="1"> <thead> <tr> <th colspan="2">ACT/LINK</th> <th colspan="2">SPEED</th> </tr> <tr> <th>LED</th> <th>Definition</th> <th>LED</th> <th>Definition</th> </tr> </thead> <tbody> <tr> <td>Light Off</td> <td>No Link</td> <td>Solid Orange</td> <td>2.5G</td> </tr> <tr> <td>Solid Yellow</td> <td>Connection</td> <td>Solid Green</td> <td>1G/100M</td> </tr> <tr> <td>Flashing</td> <td>Activity</td> <td>Light Off</td> <td>10M</td> </tr> </tbody> </table> 1G LAN Port (i219-LM) <table border="1"> <thead> <tr> <th colspan="2">ACT/LINK</th> <th colspan="2">SPEED</th> </tr> <tr> <th>LED</th> <th>Definition</th> <th>LED</th> <th>Definition</th> </tr> </thead> <tbody> <tr> <td>Light Off</td> <td>No Link</td> <td>Solid Orange</td> <td>1G</td> </tr> <tr> <td>Solid Yellow</td> <td>Connection</td> <td>Solid Green</td> <td>100M</td> </tr> <tr> <td>Flashing</td> <td>Activity</td> <td>Light Off</td> <td>10M</td> </tr> </tbody> </table> 	ACT/LINK		SPEED		LED	Definition	LED	Definition	Light Off	No Link	Solid Orange	2.5G	Solid Yellow	Connection	Solid Green	1G/100M	Flashing	Activity	Light Off	10M	ACT/LINK		SPEED		LED	Definition	LED	Definition	Light Off	No Link	Solid Orange	1G	Solid Yellow	Connection	Solid Green	100M	Flashing	Activity	Light Off	10M
ACT/LINK		SPEED																																							
LED	Definition	LED	Definition																																						
Light Off	No Link	Solid Orange	2.5G																																						
Solid Yellow	Connection	Solid Green	1G/100M																																						
Flashing	Activity	Light Off	10M																																						
ACT/LINK		SPEED																																							
LED	Definition	LED	Definition																																						
Light Off	No Link	Solid Orange	1G																																						
Solid Yellow	Connection	Solid Green	100M																																						
Flashing	Activity	Light Off	10M																																						
Audio																																									
Chipset	<ul style="list-style-type: none"> Realtek ALC888S HD codec 																																								
Audio Interface	<ul style="list-style-type: none"> Mic-In, Line-Out 																																								
Mechanical & Environmental																																									
Power Connector	<ul style="list-style-type: none"> 3-Pin Terminal Block (V+, V-, GND) 																																								
Power Requirement	<ul style="list-style-type: none"> DC in typical 12/24V (+9V ~ +36V), wide voltage single power input TVS component for surge protection Reverse current/voltage protection (Max. Currency: 13A) 																																								
Power Type	<ul style="list-style-type: none"> AT/ATX (ATX is default setting) 																																								
ACPI	<ul style="list-style-type: none"> Single power ATX Support S0,S3, S4, S5 ACPI 5.0 Compliant 																																								
Dimension (W x L x H)	<ul style="list-style-type: none"> w/o wall mount bracket: (remove by request) 240mm x 150mm x 48mm (Standard) 240mm x 150mm x 69mm (w/IET module) w/ wall mount bracket: (standard version) 279mm x 150mm x 48mm (Standard) 279mm x 150mm x 69mm (w/IET module) 																																								
Weight	<ul style="list-style-type: none"> 2.1 kg (System) _ w/o IET module 2.9 kg (w_Package) _ w/o IET module 																																								
Color	<ul style="list-style-type: none"> Avalue Box PC family design 																																								
Mounting Kit	<ul style="list-style-type: none"> Wall mount kit (standard) DIN RAIL (optional) 																																								
Reliability																																									

EMS-TGL

Vibration Test (operation)	<ul style="list-style-type: none"> 1. PSD: 0.0505G²/Hz , 5 Grms 2. Operation mode 3. Test Frequency : 5-500Hz 4. Test Axis : X,Y and Z axis 5. 30 minutes per each axis 6. IEC 60068-2-64 Test:Fh 7. Storage : SSD
Vibration Test (non-operation)	<ul style="list-style-type: none"> 1. Test Acceleration : 2G 2. Test frequency : 5~500 Hz 3. Sweep : 1 Oct/ per one minute. (logarithmic) 4. Test Axis : X,Y and Z axis Test time :30 min. each axis 5. System condition : Non-Operating mode 6. Reference IEC 60068-2-6 Testing procedures
Package vibration test	<ul style="list-style-type: none"> 1. PSD: 0.026G²/Hz , 2.16 Grms 2. Non-operation mode 3. Test Frequency : 5-500Hz 4. Test Axis : X,Y and Z axis 5. 30 min. per each axis 6. IEC 60068-2-64 Test:Fh
Shock	<ul style="list-style-type: none"> 1. Wave form : Half Sine wave 2. Acceleration Rate : 55g for operation mode 3. Duration Time : 11ms 4. No. of Shock : +/- XYZ axis 18 times 5. Operation mode 6. Reference IEC 60068-2-27 Testing procedures Test Eb : Shock Test
Package Drop Test	<ul style="list-style-type: none"> 1. One corner , three edges, six faces 2. ISTA 2A, IEC-60068-2-32 Test:Ed
IP	<ul style="list-style-type: none"> IP 50
Operating Temperature	<ul style="list-style-type: none"> -40°C ~ 70°C (w/SSD) ambient w/ air flow, WT sku -40°C ~ 60°C (w/SSD) ambient w/ air flow, WT sku (EMS-TGL-PSEBF/EMS-TGL-PSEBT) 0°C ~ 70°C (w/SSD) ambient w/ air flow, ST sku 0°C ~ 60°C (w/SSD) ambient w/ air flow, ST sku (EMS-TGL-PSEBF/EMS-TGL-PSEBT)
Operating Humidity	<ul style="list-style-type: none"> 40°C @ 95% Relative Humidity, Non-condensing
Storage Temperature	<ul style="list-style-type: none"> -30°C ~ 70°C (-22°F ~ 158°F)
Certification	<ul style="list-style-type: none"> CE, FCC Class B CF, FCC Class A (EMS-TGL-PSEBF/EMS-TGL-PSEBT/EMS-TGL-USB)
OS Supported	<ul style="list-style-type: none"> Win 10 64bit / Linux

Compliant with following Flexible IET Expansion Modules	
IET-6 LAN Bypass	• 4 x LAN support 2-Pair LAN bypass + 2 x USB 2.0
IET-6 LAN Normal	• 4 x normal LAN + 2 x USB 2.0
IET-PSEBF (4 port af)	• 4 x LAN support PoE 802.3af + 2 x USB 2.0
IET-PSEBT (2 port at)	• 2 x LAN support PoE 802.3at + 2 x USB 2.0
EBM-CDVS DB-A	• 1 x DVI-D + 2 x USB 2.0
EBM-BYTS DB-E	• 4 x USB 3.0 + 3 x USB 2.0
EBM-BYTS DB-A	• 1 x HDMI, 2 x RJ45, 2 x RS-232/422/485 (BIOS), 2 x USB 2.0
AUX-M01	• 4 x RS-232/422/485(BIOS), 2 x USB 2.0
AUX-M07	• 4 x RS-232/422/485(BIOS) w/ 2.5KV isolation, 2 x USB 2.0



Note: Specifications are subject to change without notice.

1.4 System Overview

1.4.1 Front View

EMS-TGL

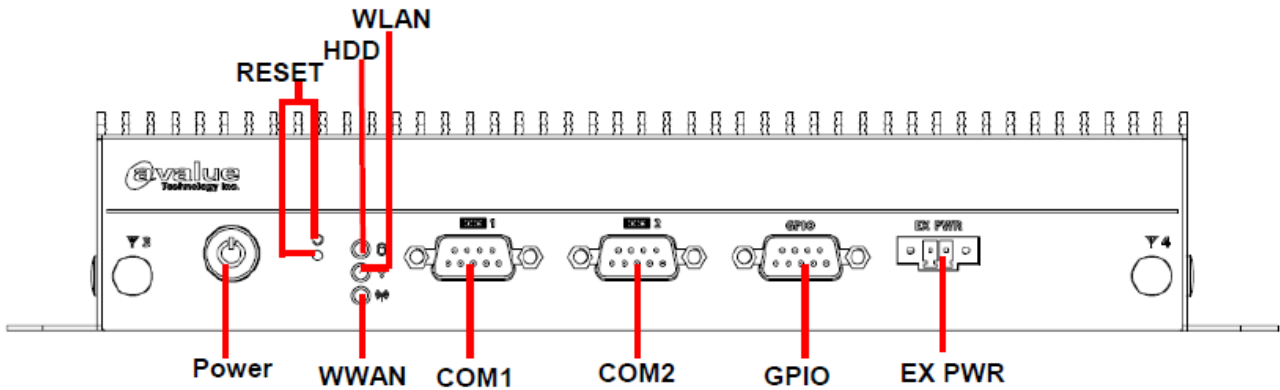

**EMS-TGL-6 COM/EMS-TGL-6 LAN Bypass/EMS-TGL-6 LAN Normal
/EMS-TGL-PSEBF/EMS-TGL-PSEBT/EMS-TGL-4 COM Isolation
/EMS-TGL-HDMI/EMS-TGL-DVI/EMS-TGL-USB**

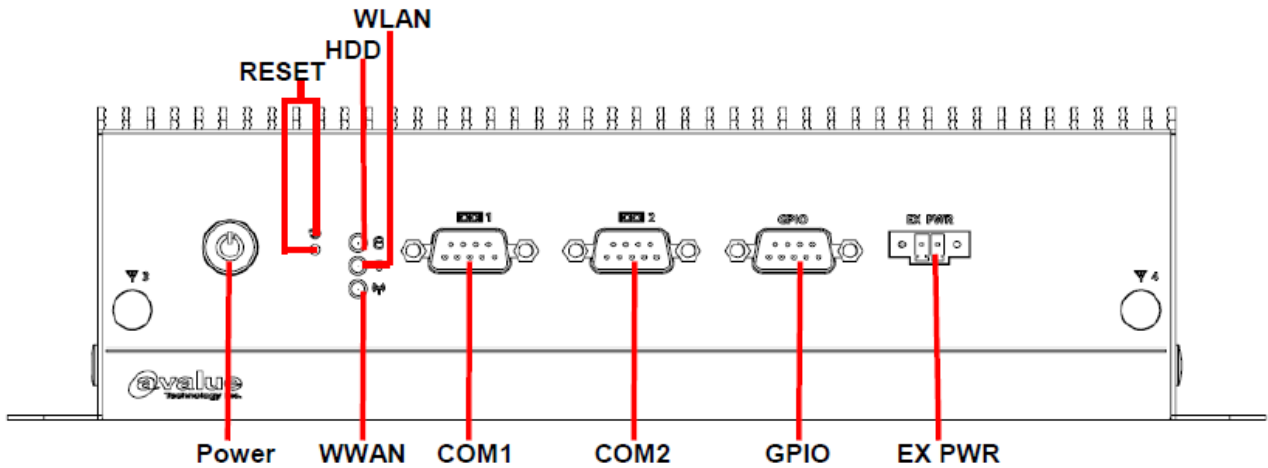

1.4.2 Rear View

EMS-TGL

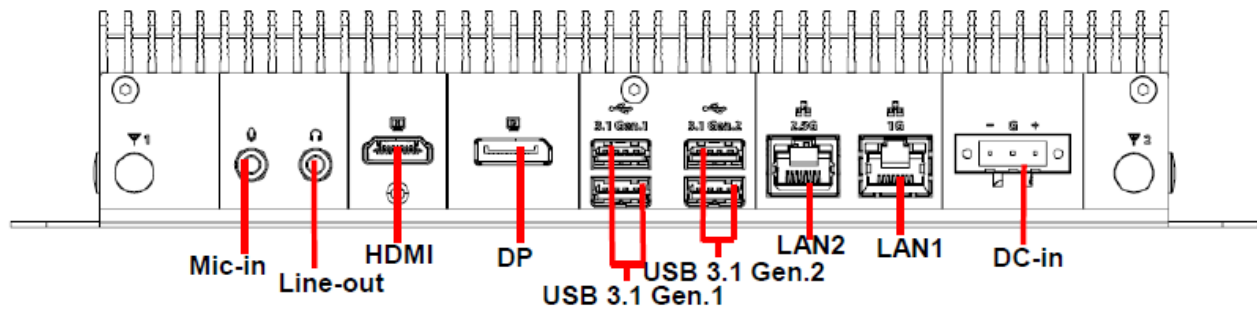

EMS-TGL-6 COM/EMS-TGL-4 COM Isolation

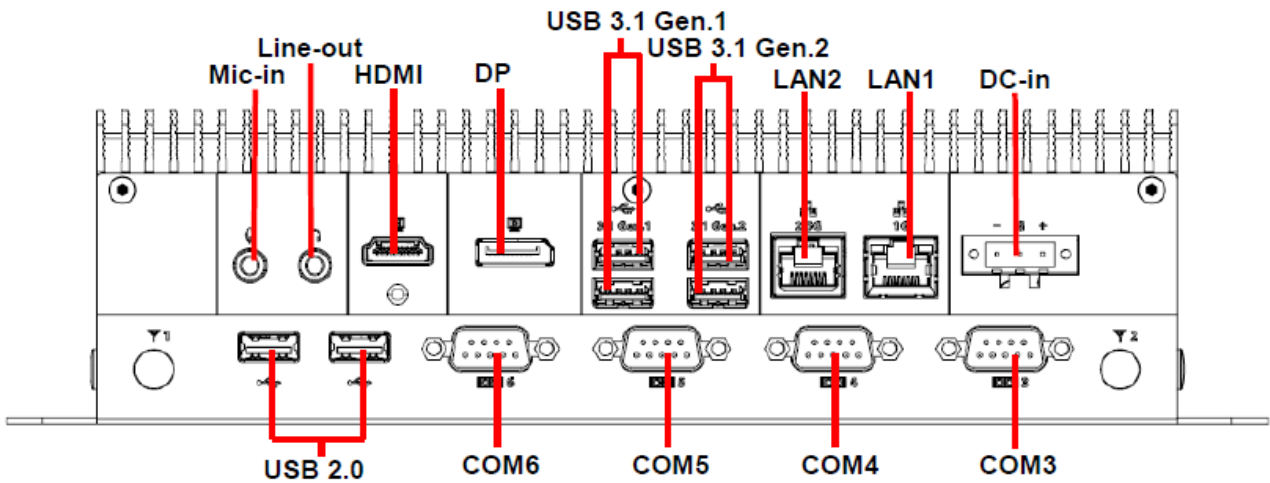

EMS-TGL-6 LAN Bypass/EMS-TGL-6 LAN Normal/EMS-TGL-PSEBF

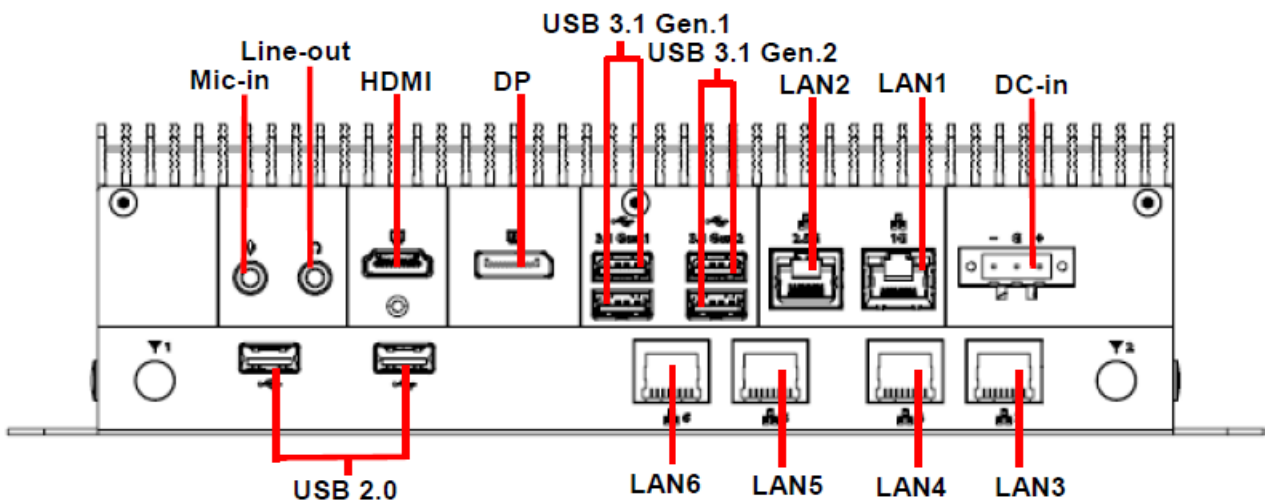

EMS-TGL-PSEBT

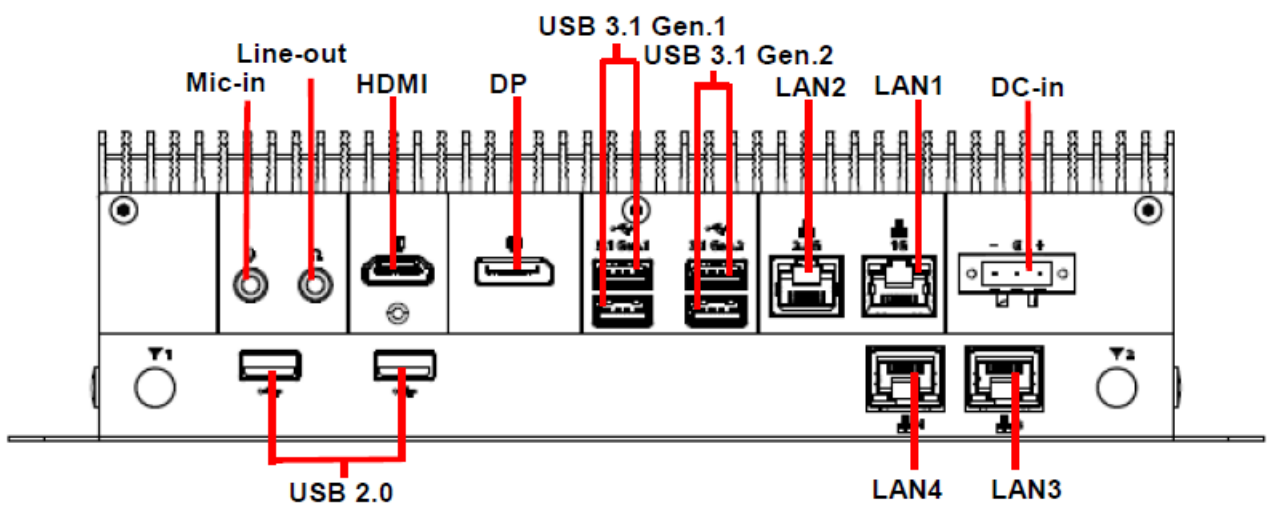

EMS-TGL-HDMI

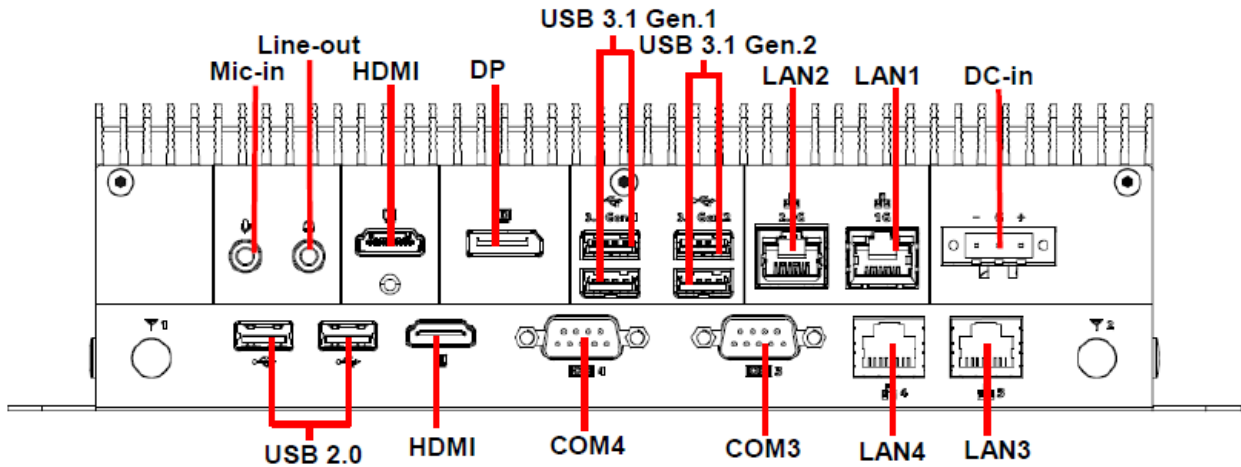

EMS-TGL-DVI

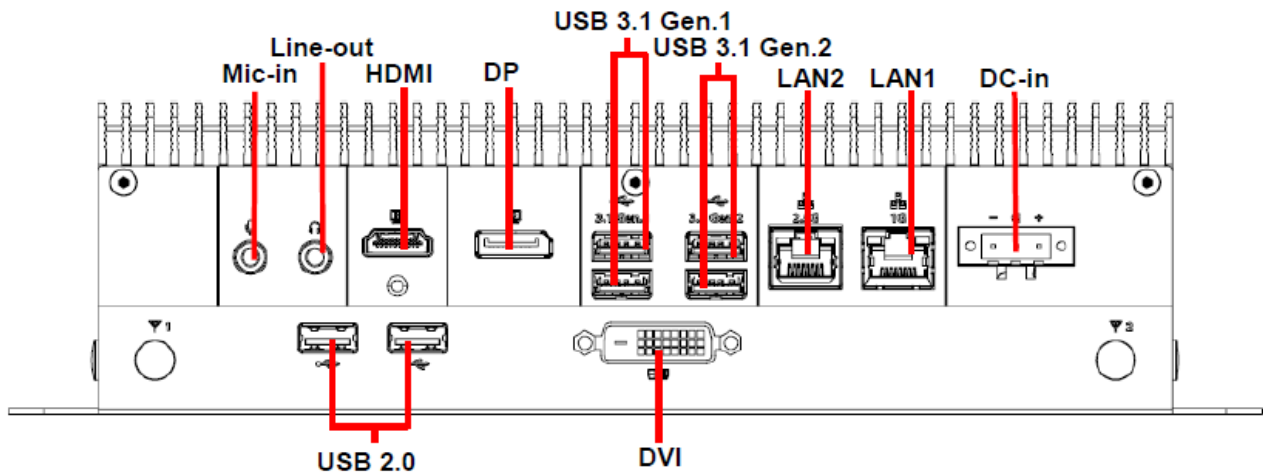

EMS-TGL-USB

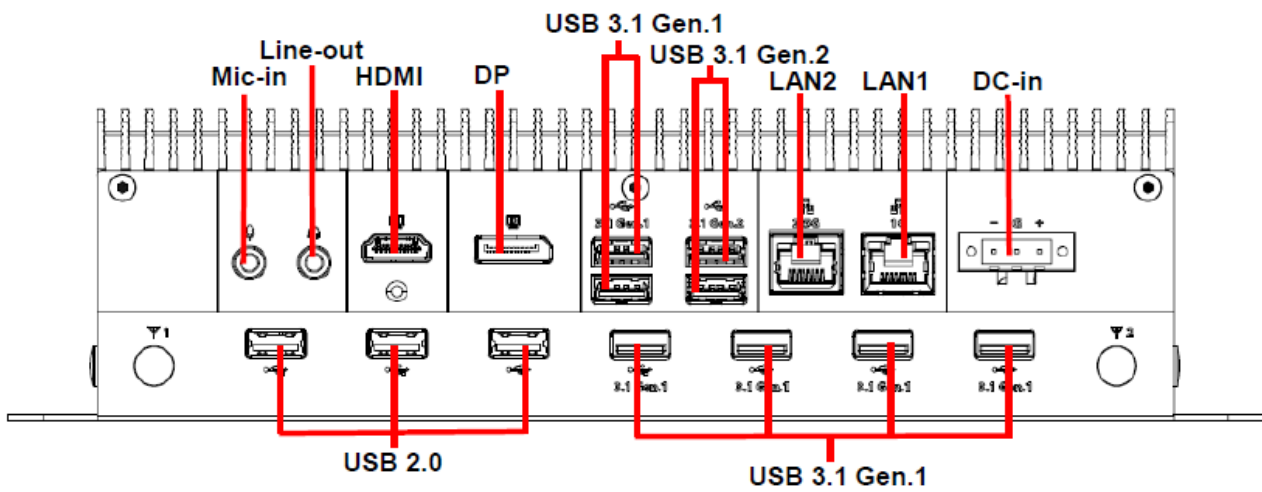

EMS-TGL**Connectors**

Label	Function	Note
Power	System power indicator	
Reset	Reset button	
HDD	HDD indicator	
WWAN	WWAN Indicator	
WLAN	WLAN Indicator	
COM1/2	Serial port connector 1/2	
GPIO	General purpose I/O connector	
EX PWR	Power on button	
Mic-in	Mic-in audio jack	
Line-out	Line-out jack	
HDMI	HDMI connector	
DP	DP connector	
USB 3.1 Gen.1	2 x USB 3.1 Gen.1 connector	
USB 3.1 Gen.2	2 x USB 3.1 Gen.2 connector	
LAN1/2	RJ-45 Ethernet 1/2	
DC-in	DC power-in connector	

EMS-TGL-6 COM/EMS-TGL-4 COM Isolation**Connectors**

Label	Function	Note
Power	System power indicator	
Reset	Reset button	
HDD	HDD indicator	
WWAN	WWAN Indicator	
WLAN	WLAN Indicator	
COM1/2/3/4/5/6	Serial port connector 1/2/3/4/5/6	
GPIO	General purpose I/O connector	
EX PWR	Power on button	
Mic-in	Mic-in audio jack	
Line-out	Line-out jack	
HDMI	HDMI connector	
DP	DP connector	

EMS-TGL

USB 3.1 Gen.1	2 x USB 3.1 Gen.1 connector
USB 3.1 Gen.2	2 x USB 3.1 Gen.2 connector
USB 2.0	2 x USB 2.0 connector
LAN1/2	RJ-45 Ethernet 1/2
DC-in	DC power-in connector

EMS-TGL-6 LAN Bypass/EMS-TGL-6 LAN Normal/EMS-TGL-PSEBF

Connectors

Label	Function	Note
Power	System power indicator	
Reset	Reset button	
HDD	HDD indicator	
WWAN	WWAN Indicator	
WLAN	WLAN Indicator	
COM1/2	Serial port connector 1/2	
GPIO	General purpose I/O connector	
EX PWR	Power on button	
Mic-in	Mic-in audio jack	
Line-out	Line-out jack	
HDMI	HDMI connector	
DP	DP connector	
USB 3.1 Gen.1	2 x USB 3.1 Gen.1 connector	
USB 3.1 Gen.2	2 x USB 3.1 Gen.2 connector	
USB 2.0	2 x USB 2.0 connector	
LAN1/2/3/4/5/6	RJ-45 Ethernet 1/2/3/4/5/6	
DC-in	DC power-in connector	

EMS-TGL-PSEBT

Connectors

Label	Function	Note
Power	System power indicator	
Reset	Reset button	
HDD	HDD indicator	
WWAN	WWAN Indicator	
WLAN	WLAN Indicator	
COM1/2	Serial port connector 1/2	

GPIO	General purpose I/O connector
EX PWR	Power on button
Mic-in	Mic-in audio jack
Line-out	Line-out jack
HDMI	HDMI connector
DP	DP connector
USB 3.1 Gen.1	2 x USB 3.1 Gen.1 connector
USB 3.1 Gen.2	2 x USB 3.1 Gen.2 connector
USB 2.0	2 x USB 2.0 connector
LAN1/2/3/4	RJ-45 Ethernet 1/2/3/4
DC-in	DC power-in connector

EMS-TGL-HDMI

Connectors

Label	Function	Note
Power	System power indicator	
Reset	Reset button	
HDD	HDD indicator	
WWAN	WWAN Indicator	
WLAN	WLAN Indicator	
COM1/2/3/4	Serial port connector 1/2/3/4	
GPIO	General purpose I/O connector	
EX PWR	Power on button	
Mic-in	Mic-in audio jack	
Line-out	Line-out jack	
HDMI	2 x HDMI connector	
DP	DP connector	
USB 3.1 Gen.1	2 x USB 3.1 Gen.1 connector	
USB 3.1 Gen.2	2 x USB 3.1 Gen.2 connector	
USB 2.0	2 x USB 2.0 connector	
LAN1/2/3/4	RJ-45 Ethernet 1/2/3/4	
DC-in	DC power-in connector	

EMS-TGL-DVI

Connectors

Label	Function	Note
-------	----------	------

EMS-TGL

Power	System power indicator
Reset	Reset button
HDD	HDD indicator
WWAN	WWAN Indicator
WLAN	WLAN Indicator
COM1/2	Serial port connector 1/2
GPIO	General purpose I/O connector
EX PWR	Power on button
Mic-in	Mic-in audio jack
Line-out	Line-out jack
HDMI	HDMI connector
DP	DP connector
DVI	DVI connector
USB 3.1 Gen.1	2 x USB 3.1 Gen.1 connector
USB 3.1 Gen.2	2 x USB 3.1 Gen.2 connector
USB 2.0	2 x USB 2.0 connector
LAN1/2	RJ-45 Ethernet 1/2
DC-in	DC power-in connector

EMS-TGL-USB

Connectors

Label	Function	Note
Power	System power indicator	
Reset	Reset button	
HDD	HDD indicator	
WWAN	WWAN Indicator	
WLAN	WLAN Indicator	
COM1/2	Serial port connector 1/2	
GPIO	General purpose I/O connector	
EX PWR	Power on button	
Mic-in	Mic-in audio jack	
Line-out	Line-out jack	
HDMI	HDMI connector	
DP	DP connector	
USB 3.1 Gen.1	6 x USB 3.1 Gen.1 connector	
USB 3.1 Gen.2	2 x USB 3.1 Gen.2 connector	

USB 2.0	3 x USB 2.0 connector
LAN1/2	RJ-45 Ethernet 1/2
DC-in	DC power-in connector

1.5 System Dimensions

1.5.1 EMS-TGL Front & Top view

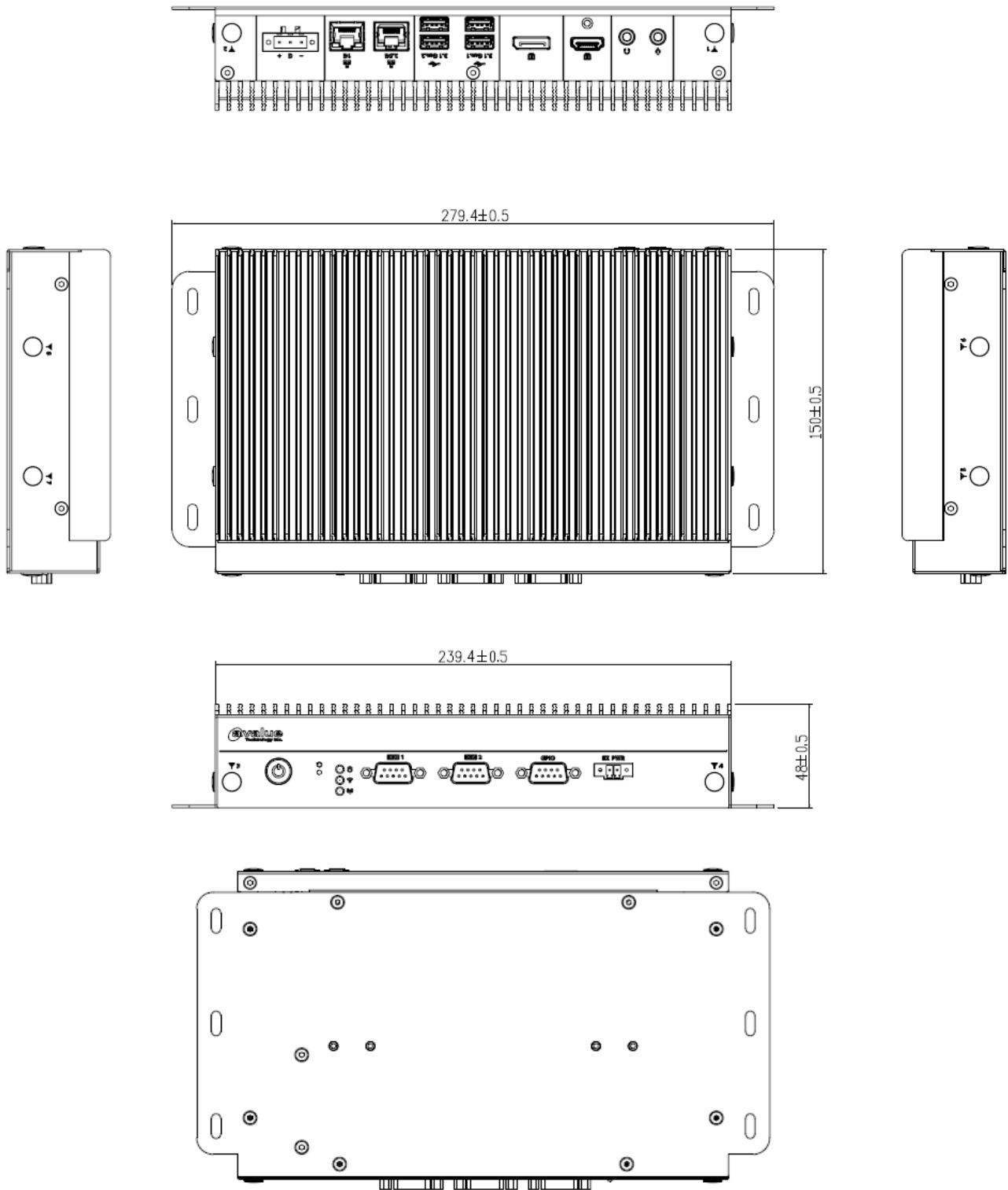

(Unit: mm)

1.5.2 EMS-TGL-6 COM/EMS-TGL-4 COM Isolation Front & Top view

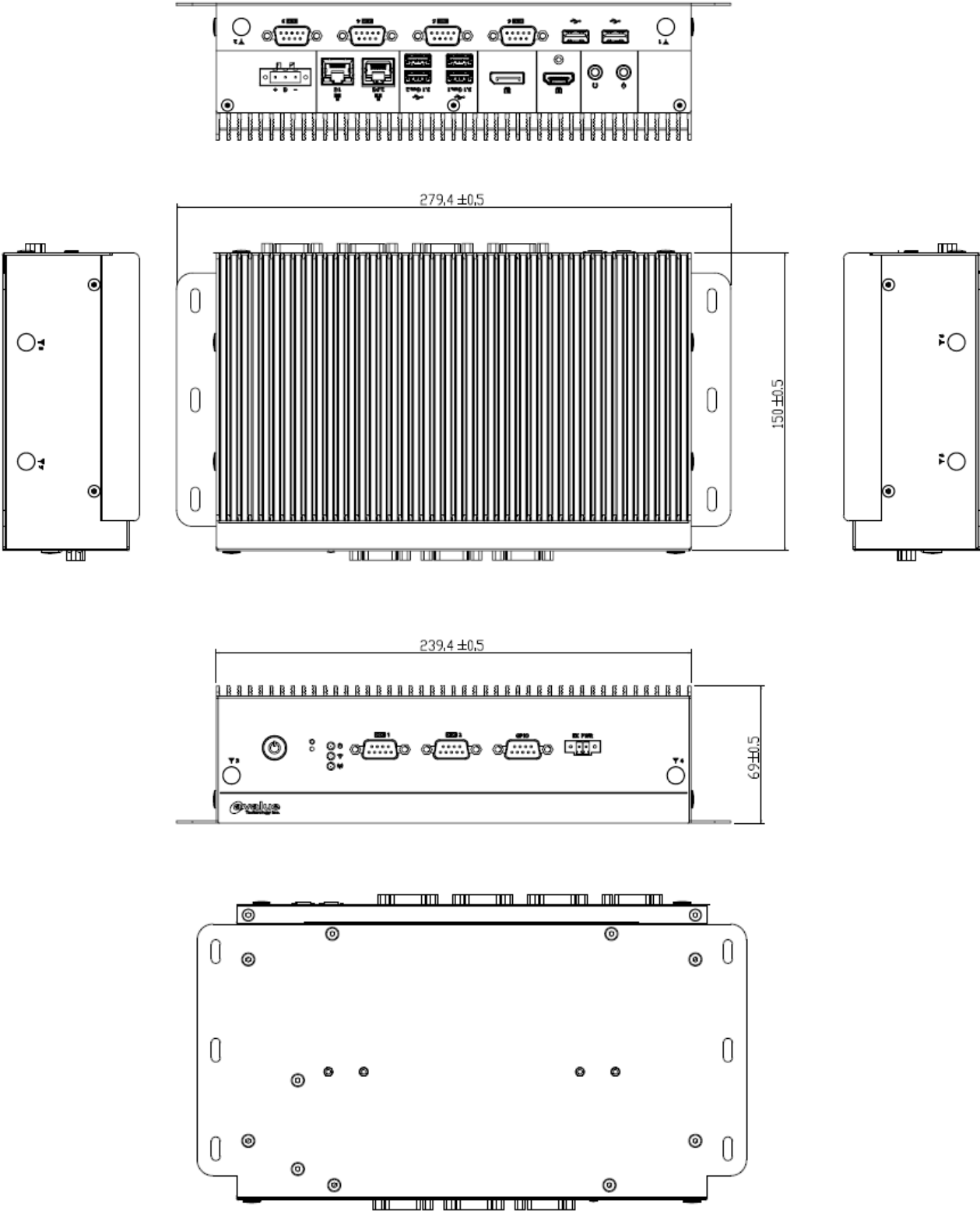

(Unit: mm)

EMS-TGL

1.5.3 EMS-TGL-6 LAN Bypass/EMS-TGL-6 LAN Normal/EMS-TGL-PSEBF Front & Top view

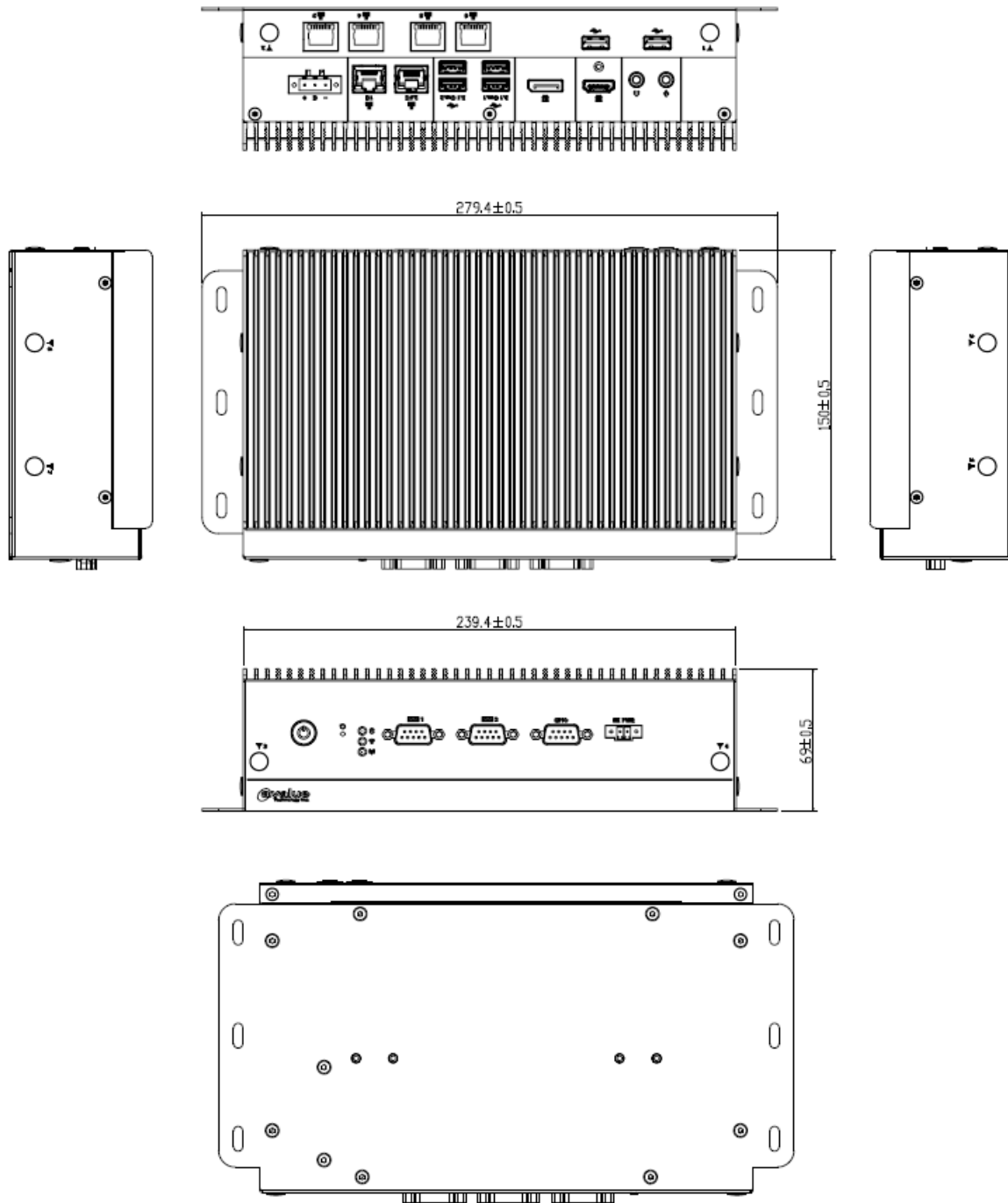

(Unit: mm)

1.5.4 EMS-TGL-PSEBT Front & Top view

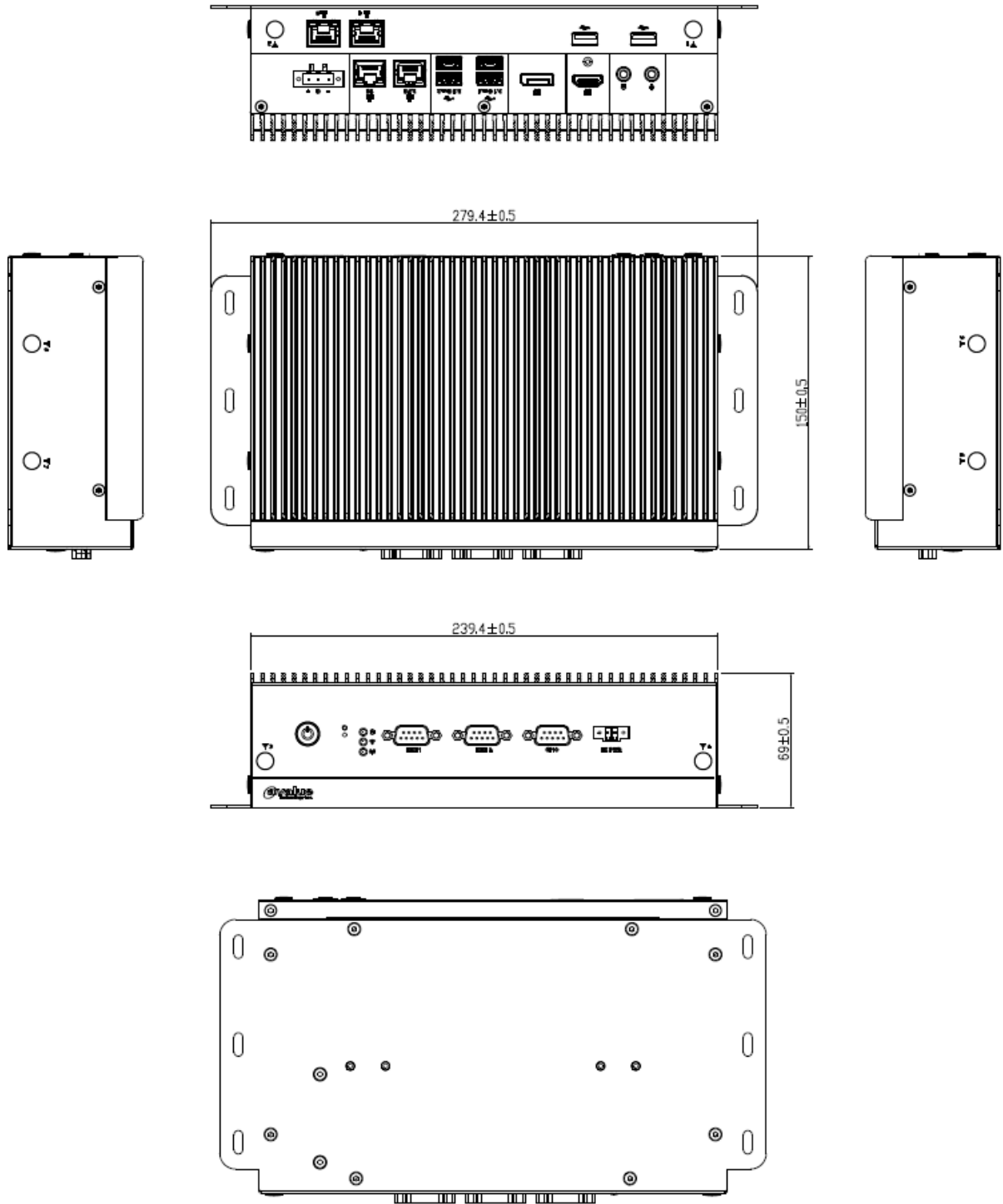

(Unit: mm)

EMS-TGL

1.5.5 EMS-TGL-HDMI Front & Top view

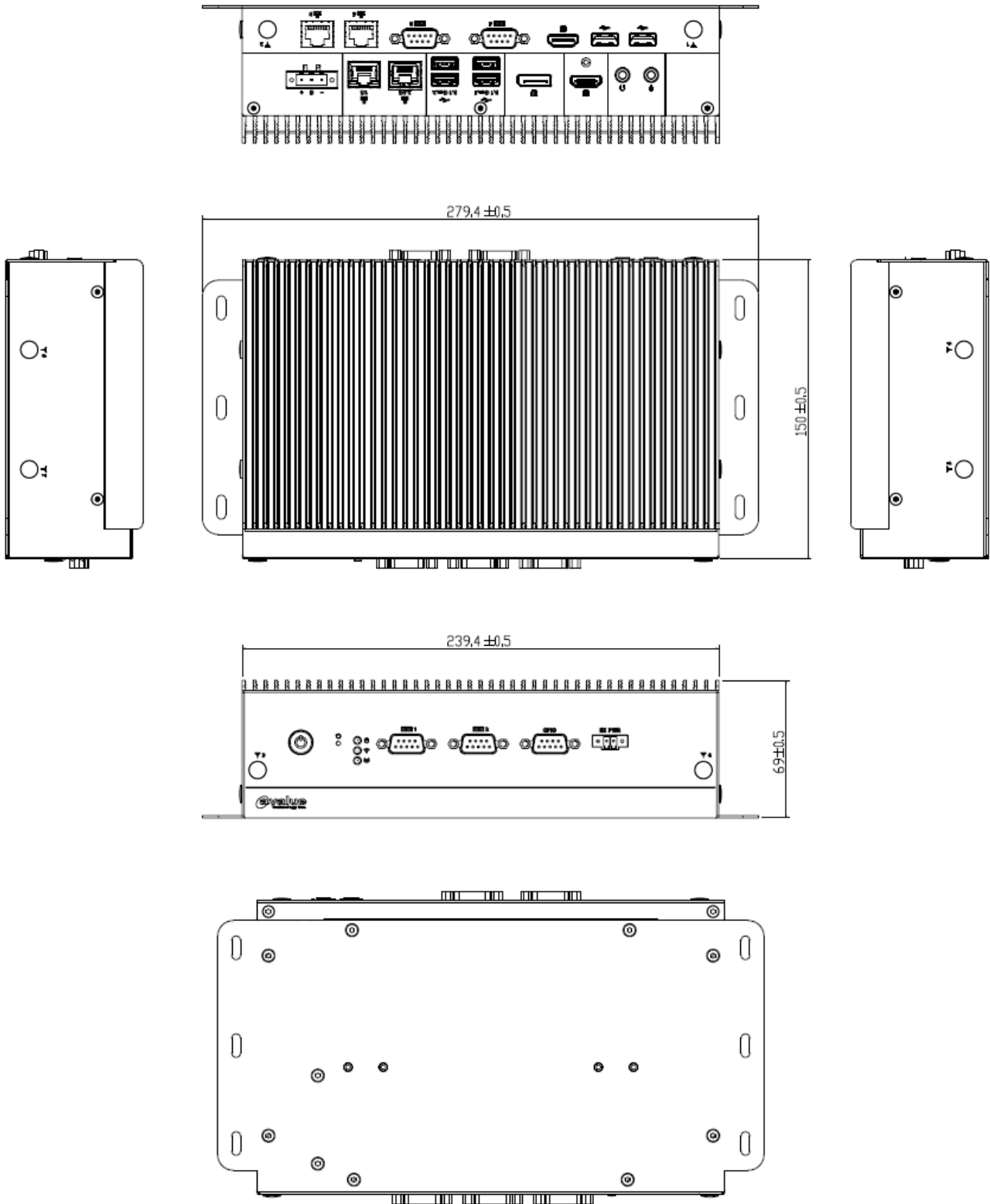

(Unit: mm)

1.5.6 EMS-TGL-DVI Front & Top view

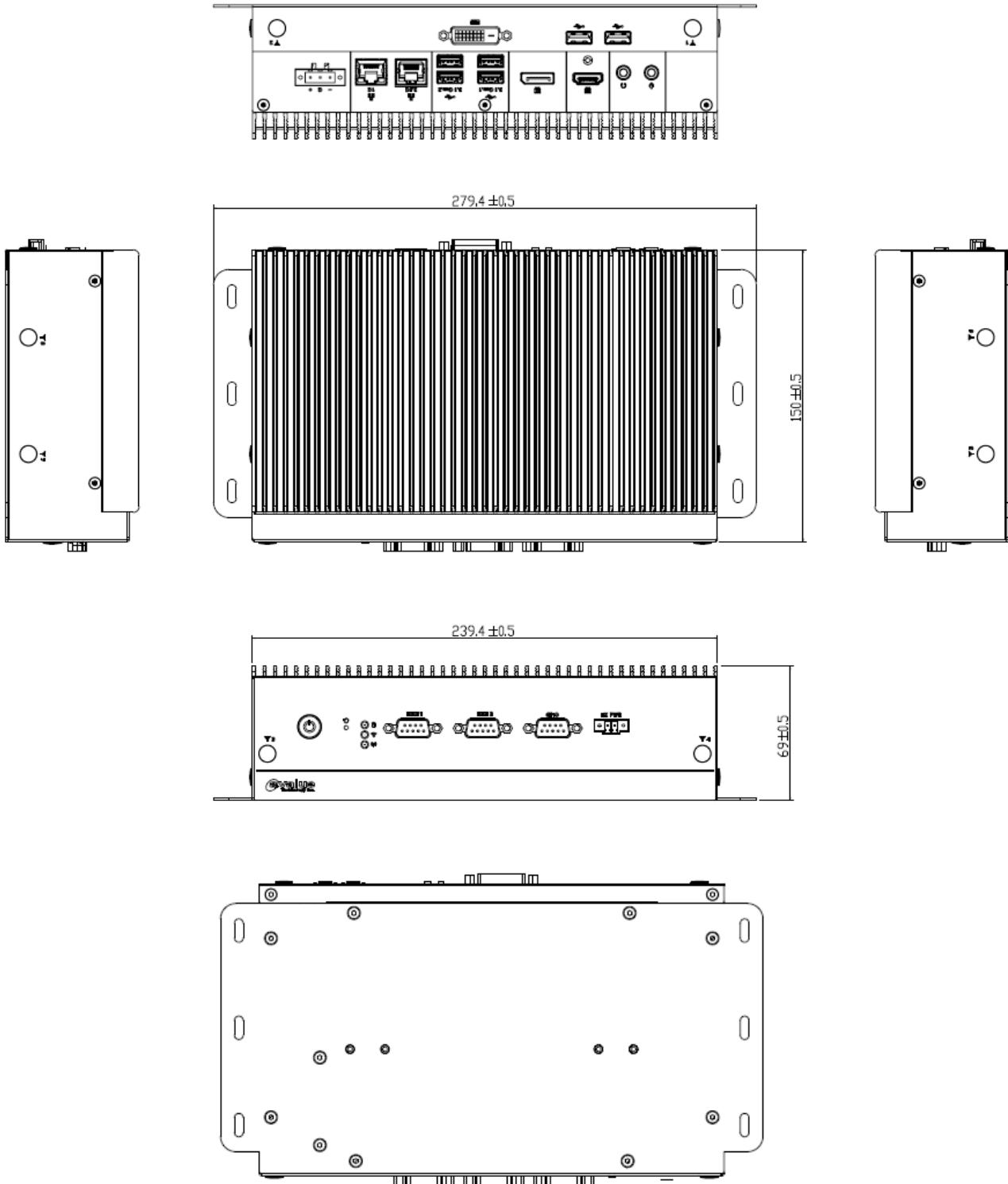

(Unit: mm)

EMS-TGL

1.5.7 EMS-TGL-USB Front & Top view

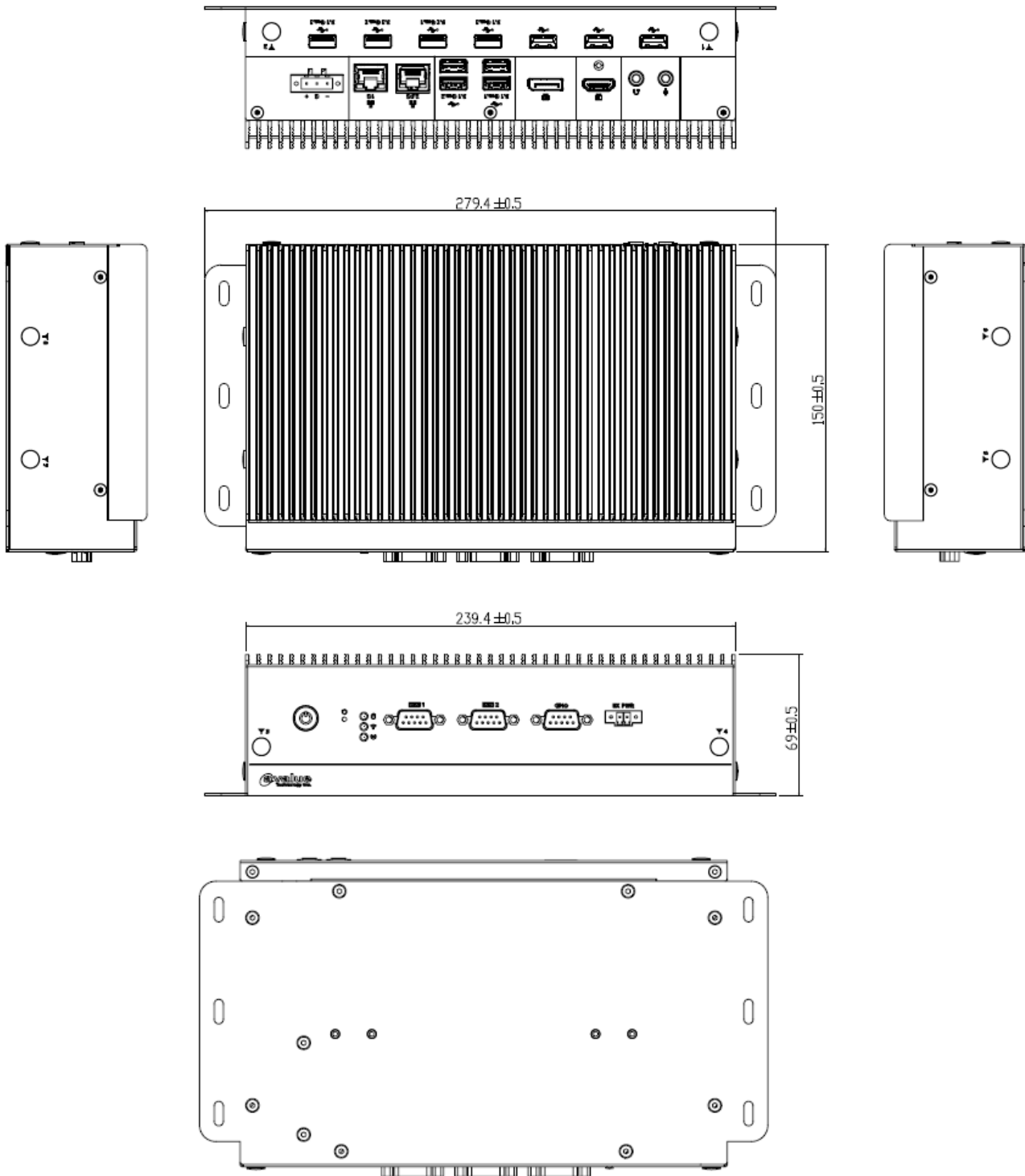

(Unit: mm)

2. Hardware Configuration

Jumper and Connector Setting, Driver and BIOS Installing

For advanced information, please refer to:

- 1- EBM-TGLS, AUX-M01, IET-6 LAN Bypass, IET-6 LAN Normal, IET-PSEBF (4 port af), IET-PSEBT (2 port at), AUX-M07, EBM-BYTS DB-A, EBM-CDVS DB-A and EBM-BYTS DB-E included in this manual.



Note: If you need more information, please visit our website:

<http://www.avalue.com.tw>

2.1 EMS-TGL connector mapping

2.1.1 Serial port connector 1/2 (COM1/2)

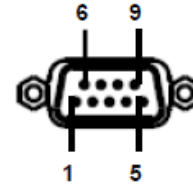
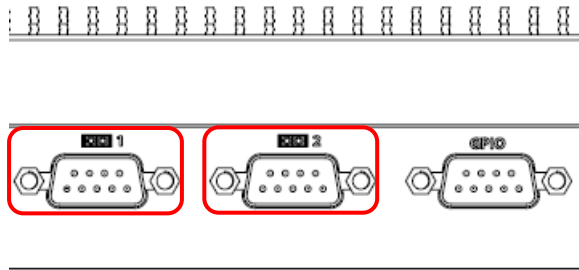

In RS-232 Mode

Signal	PIN	PIN	Signal
NDCD#	1	6	NDSR#
NRXD	2	7	NRTS#
NTXD	3	8	NCTS#
NDTR#	4	9	NRI#
GND	5		

In RS-422 Mode

Signal	PIN	PIN	Signal
TxD1-	1	6	NC
TxD1+	2	7	NC
RxD1+	3	8	NC
RxD1-	4	9	NC
GND	5		

In RS-485 Mode

Signal	PIN	PIN	Signal
DATA1-	1	6	NC
DATA1+	2	7	NC
NC	3	8	NC
NC	4	9	NC
GND	5		

2.1.2 Serial port 3/4/5/6 connector (COM3/4/5/6)

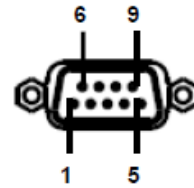
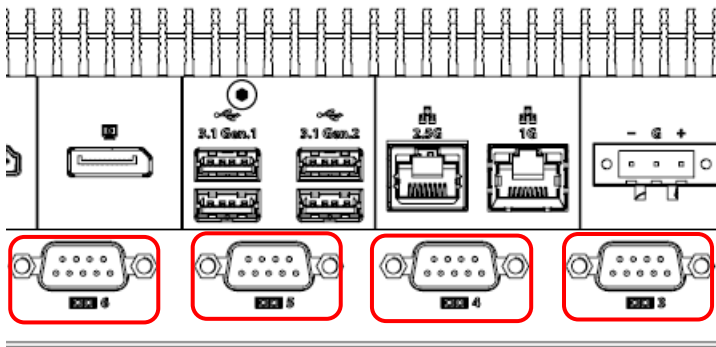

Signal	PIN	PIN	Signal
NDCD#	1	6	NDSR#
NRXD	2	7	NRTS#
NTXD	3	8	NCTS#
NDTR#	4	9	NRI#
GND	5		

2.1.3 General purpose I/O connector (GPIO)

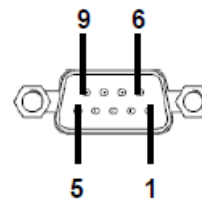
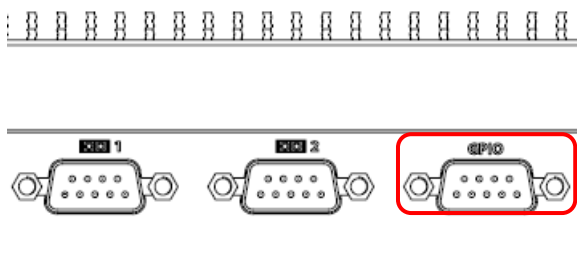

Signal	PIN	PIN	Signal
DIO_GP20	1	6	DIO_GP10
DIO_GP21	2	7	DIO_GP11
DIO_GP22	3	8	DIO_GP12
DIO_GP23	4	9	DIO_GP13
GND	5		

2.1.4 DC power-in connector (DC-in)

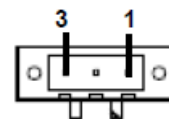
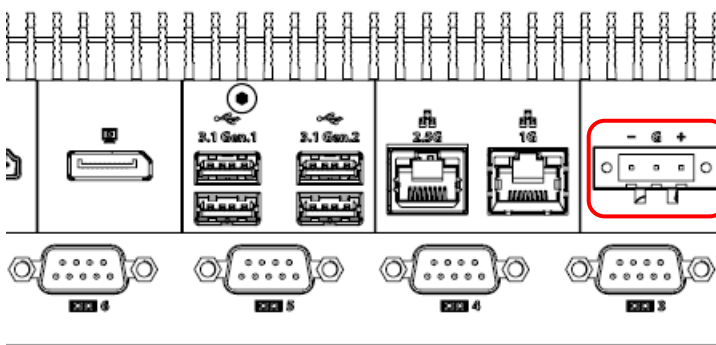

Signal	PIN
VIN + (BAT+)	1
CHASSIS_GND	2
VIN- (BAT-)	3

2.2 EBM-TGLS, AUX-M01, IET-6 LAN Bypass, IET-6 LAN Normal, IET-PSEBF (4 port af), IET-PSEBT (2 port at), AUX-M07, EBM-BYTS DB-A, EBM-CDVS DB-A and EBM-BYTS DB-E Overviews

2.2.1 EBM-TGLS

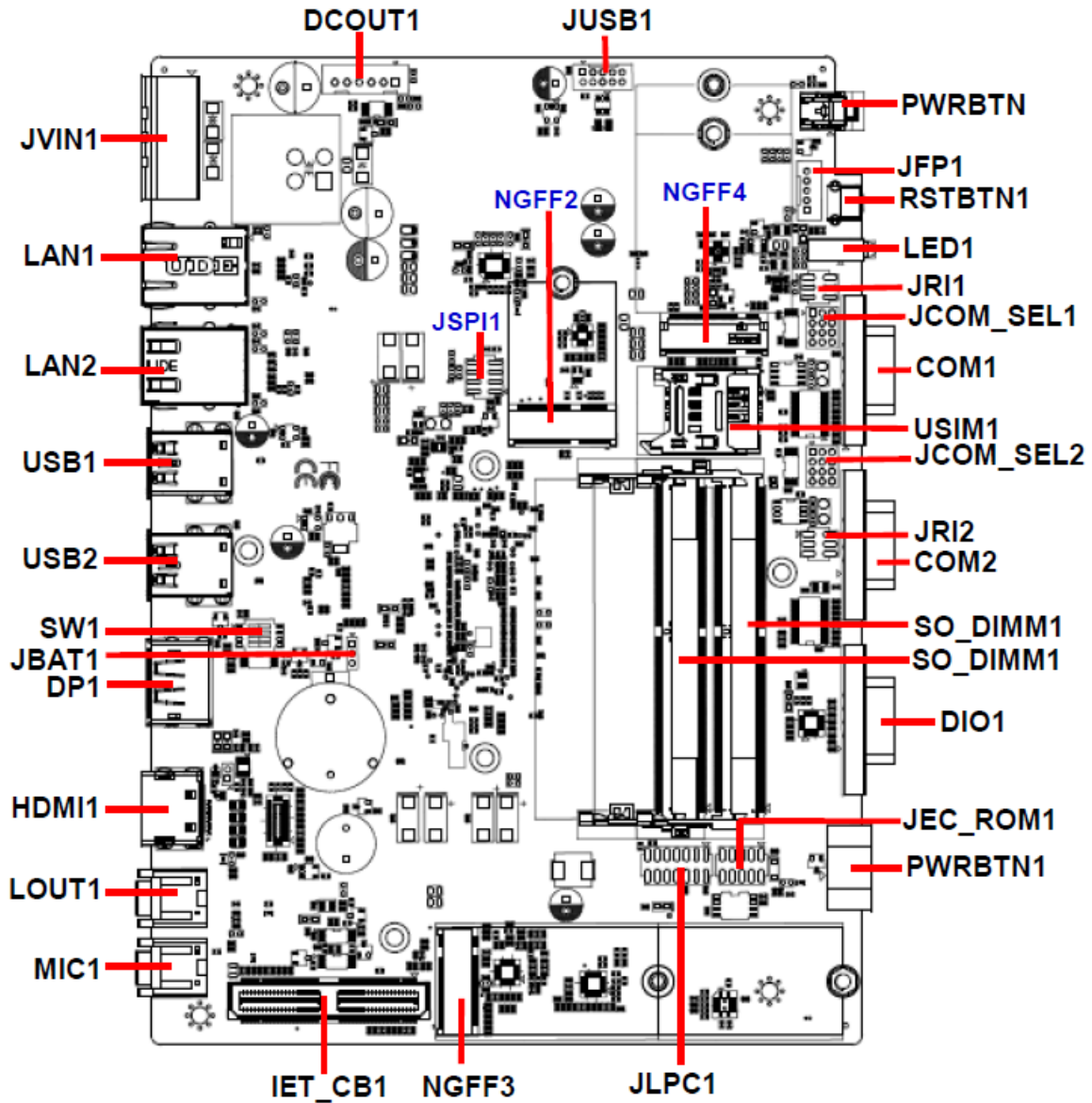

2.2.2 AUX-M01

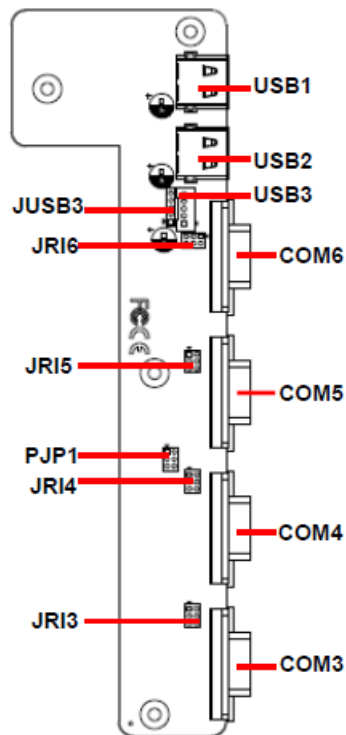

2.2.3 IET-6 LAN Bypass

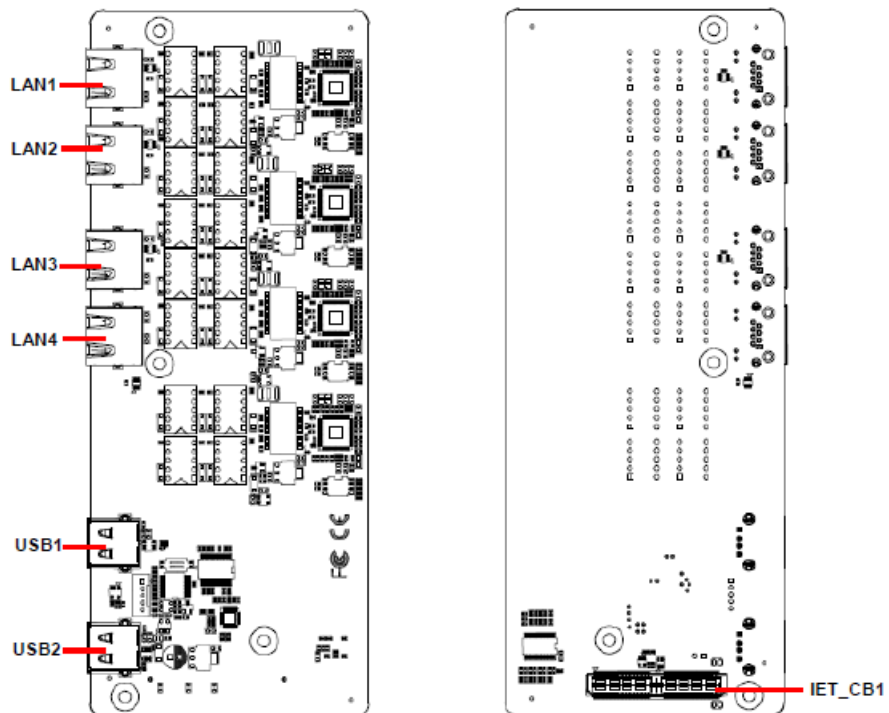

2.2.4 IET-6 LAN Normal

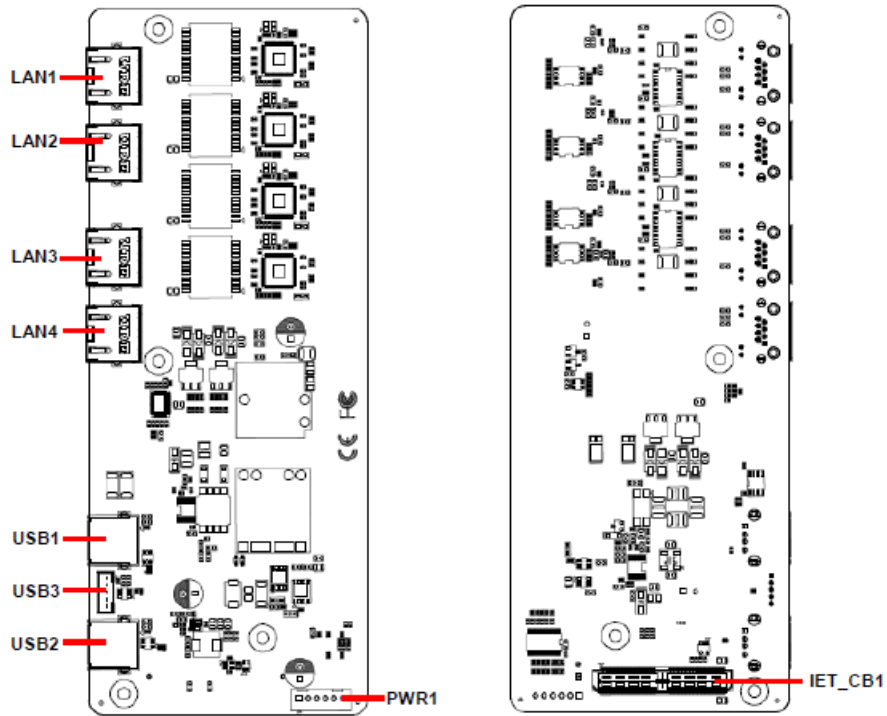

2.2.5 IET-PSEBF (4 port af)

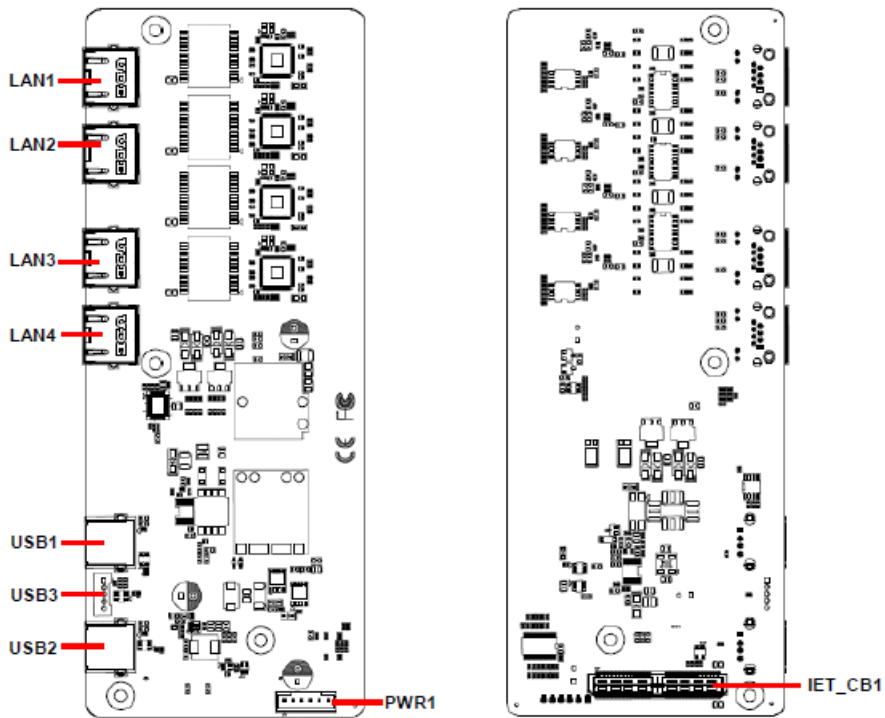

2.2.6 IET-PSEBT (2 port at)

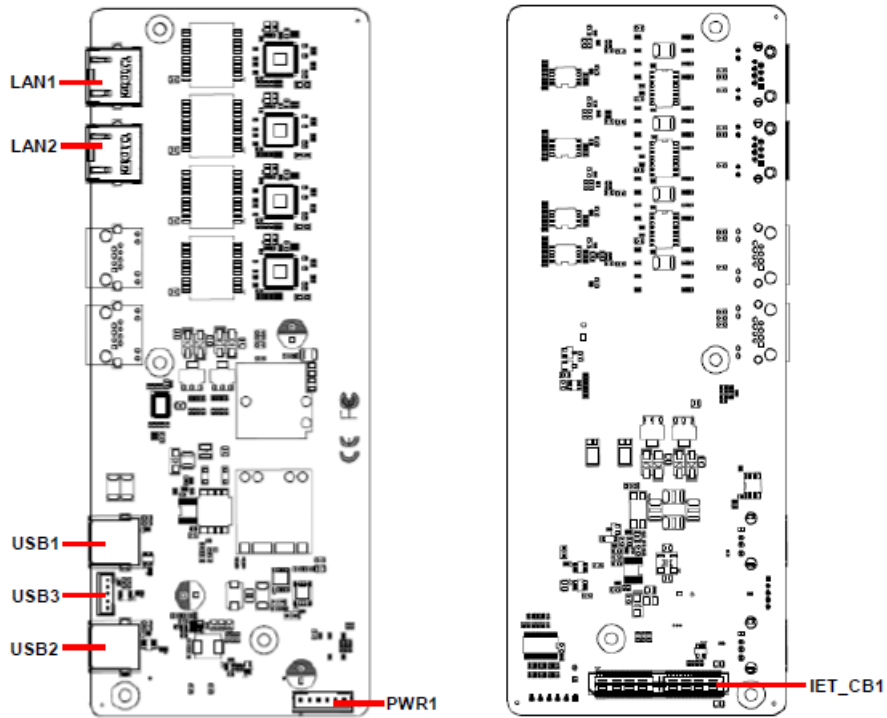

2.2.7 AUX-M07

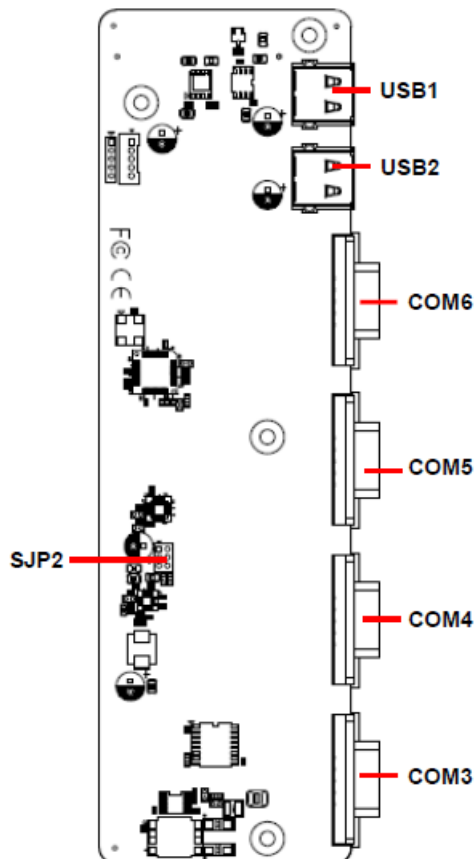

EMS-TGL

2.2.8 EBM-BYTS DB-A

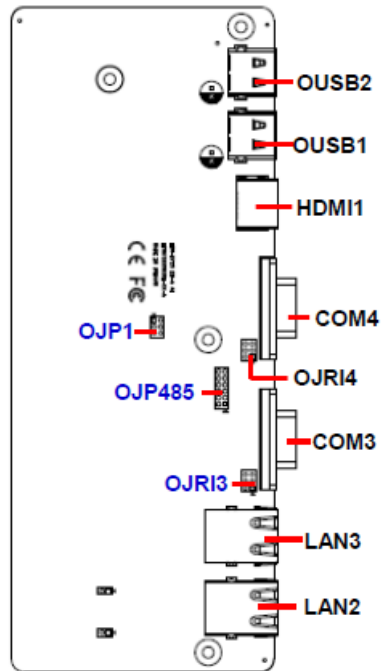

2.2.9 EBM-CDVS DB-A

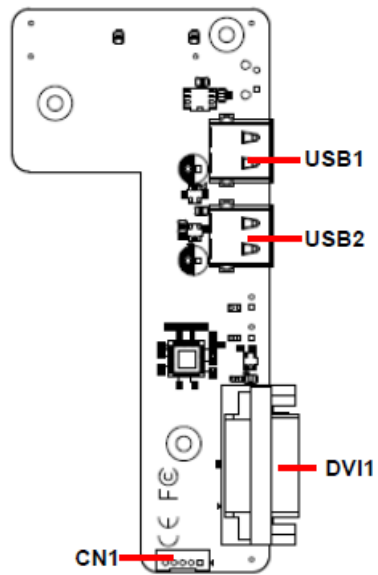

2.2.10 EBM-BYTS DB-E

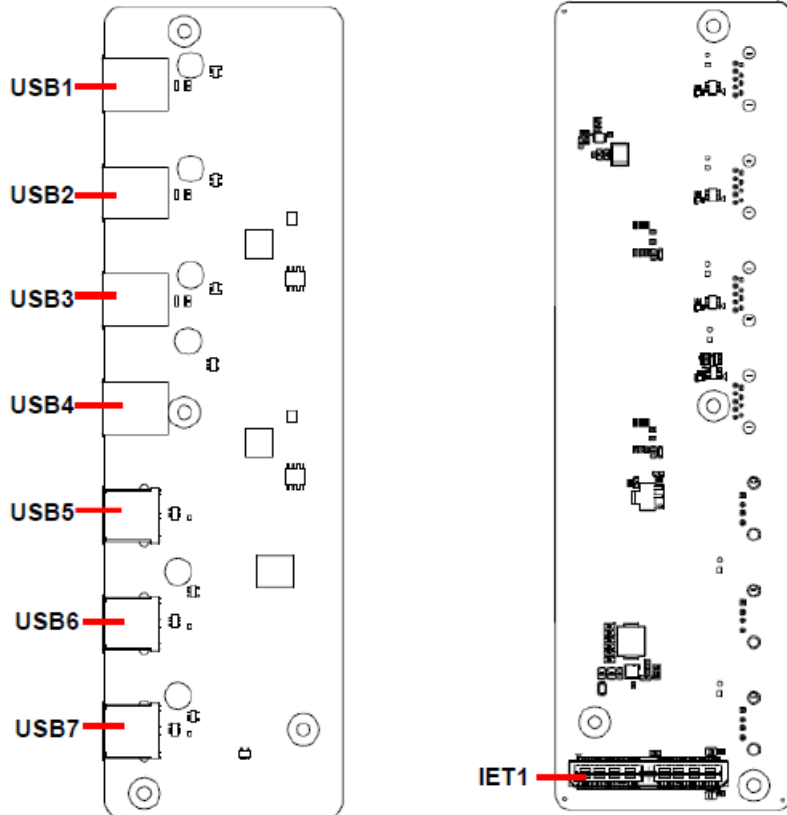

2.3 EBM-TGLS Jumper & Connector list

Jumpers

Label	Function	Note
JBAT1	Clear CMOS	3 x 1 header, pitch 2.00 mm
JRI1/2	Serial port 1/2 pin 9 signal select	3 x 2 header, pitch 2.00 mm
JCOM_SEL1/2	Serial port 1/2 – RS232/422/485 mode select	4 x 3 header, pitch 2.00 mm
SW1	Multi-function select	SMT switch 4pin

Connectors

Label	Function	Note
USB1	2 x USB3.1 Gen.2 connector	
USB2	2 x USB3.1 Gen.1 connector	
JUSB1	On-board header for USB2.0	5 x 2 wafer, pitch 2.00 mm
DIO1	General purpose I/O connector	
LAN1/2	RJ-45 Ethernet 1/2	
LOUT1	Audio line-out connector	
MIC1	Audio mic-in connector	
COM1/2	Serial port connector 1/2	
USIM1	SIM card slot	
JFP1	Front Panel Connector	5 x 1 wafer, pitch 2.00 mm
PWRBTN1	Power on/off connector	1 x 2 terminal block, pitch 3.50 mm
PWRBTN	Power on/off button	
RSTBTN1	Reset button	
LED1	WWAN 、WIFI & Storage	
RSTBTN1	Reset button	
HDMI1	HDMI connector	
SO_DIMM1/2	2 x DDR4 SODIMM connector	
IET_CB1	IET Expansion slot	
JLPC1	LPC port connector	7 x 2 header, pitch 2.00 mm
JSPI1	SPI connector	4 x 2 header, pitch 2.00 mm
DP1	DP connector	
NGFF2	M.2 KEY-E 2230 connector	

NGFF3	M.2 KEY-M 2242/2280 connector	
NGFF4	M.2 KEY-B 2242/3042/3052 connector	
DCOUT1	DC Output connector	6 x 1 wafer, pitch 2.50 mm
JVIN1	DC Input connector	1 x 3 terminal block, pitch 5.08 mm
JEC_ROM1	EC Debug connector	5 x 2 header, pitch 2.00 mm

2.4 EBM-TGLS Jumpers & Connectors settings

2.4.1 Multi-function select (SW1)

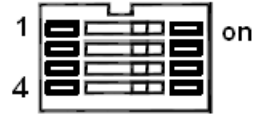
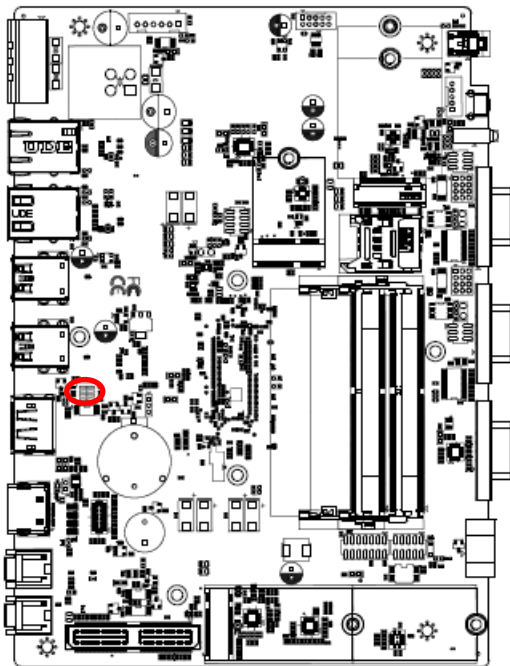

Power mode

	AT	ATX*
1	ON	OFF

DDI2 mode(DP+)

	DisplayPort*	HDMI	Cable select
2	OFF	OFF	ON
3	ON	OFF	OFF

2.4.2 Serial port 1/2 pin 9 signal select (JRI1/2)

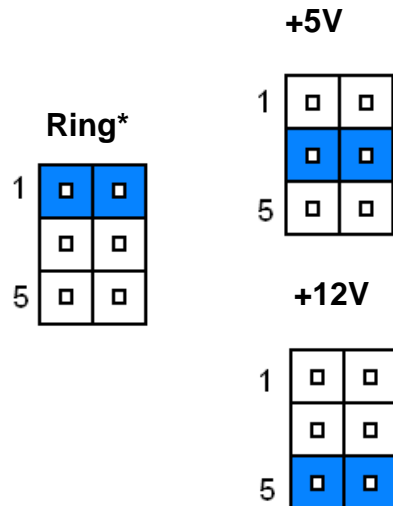
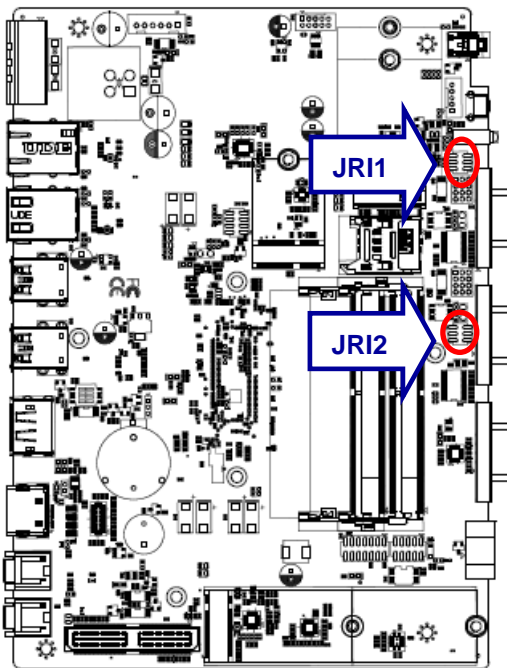

* Default

2.4.3 Serial port 1/2 RS-232/422/485 mode select (JCOM_SEL1/2)

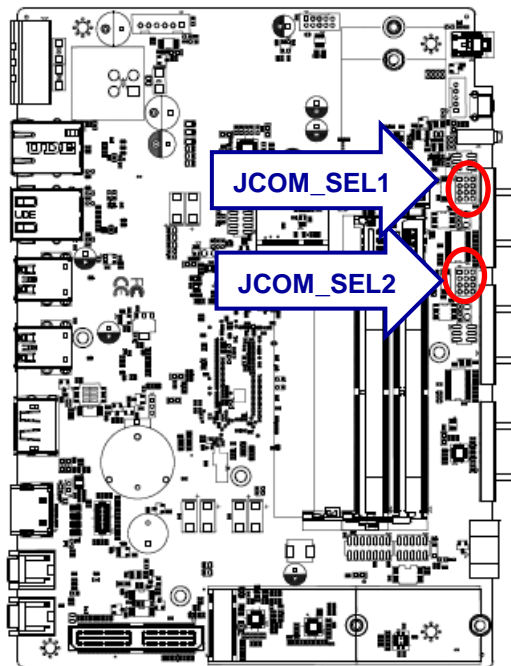

RS-232*

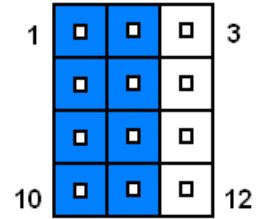

RS-422/ 485

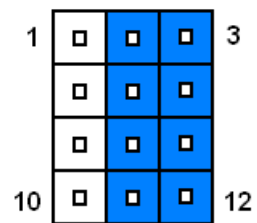

*Default

2.4.4 Clear CMOS (JBAT1)

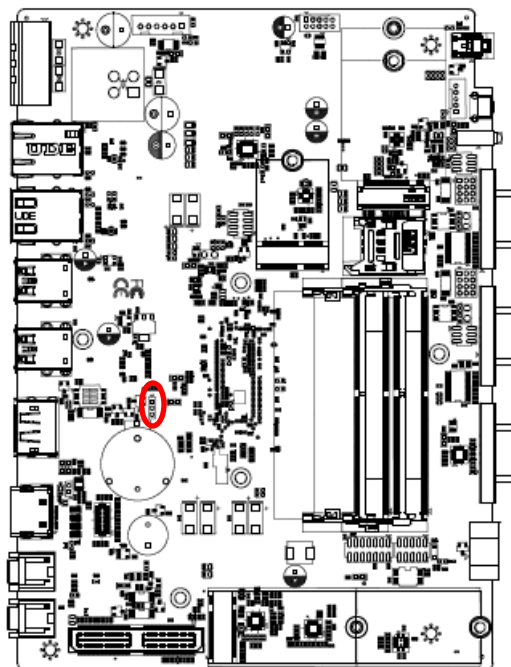

Protect *



Clear CMOS



*Default

2.4.5 LPC port connector (JLPC1)

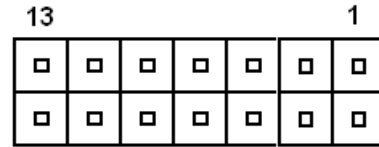
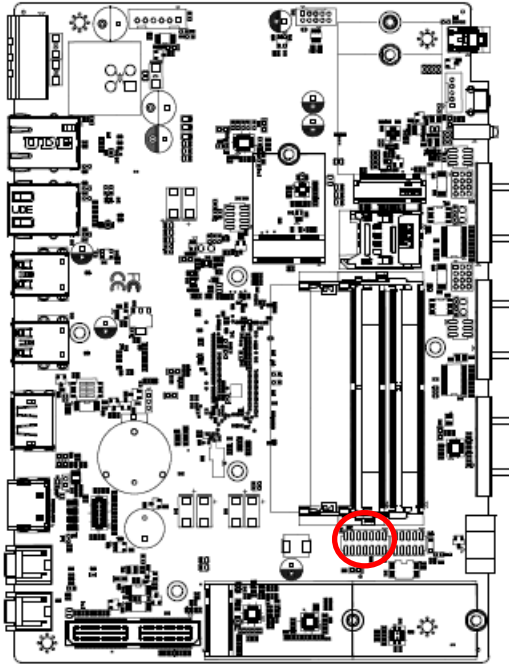

Signal	PIN	PIN	Signal
LPC_AD0	1	2	+3.3V
LPC_AD1	3	4	IET_RST#
LPC_AD2	5	6	LPC_LFRAME#
LPC_AD3	7	8	CLK_24M_80
LPC_SERIRQ	9	10	GND
+5V	11	12	GND
+5VSB	13	14	NC

2.4.6 SPI connector (JSPI1)

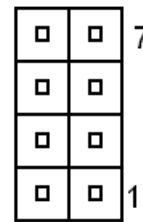
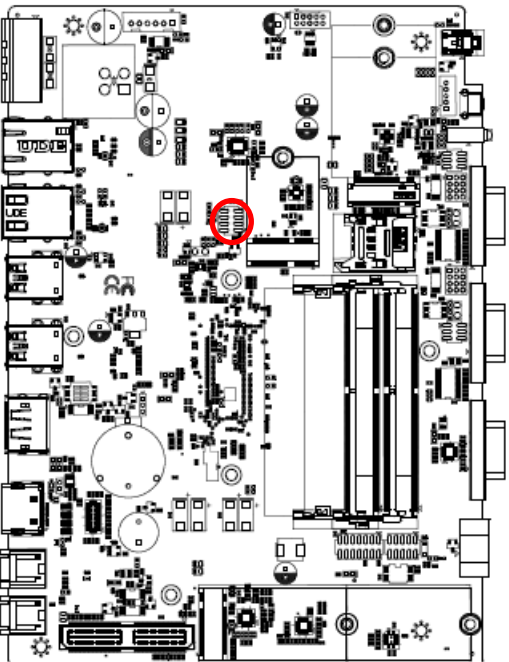

Signal	PIN	PIN	Signal
BIOS_WP#	8	7	BIOS_HOLD#
SPI0_BIOS_MOSI	6	5	SPI0_BIOS_MISO
SPI0_BIOS_CLK	4	3	SPI0_CS0#
GND	2	1	+3.3VSB

2.4.7 Front Panel Connector (JFP1)

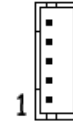
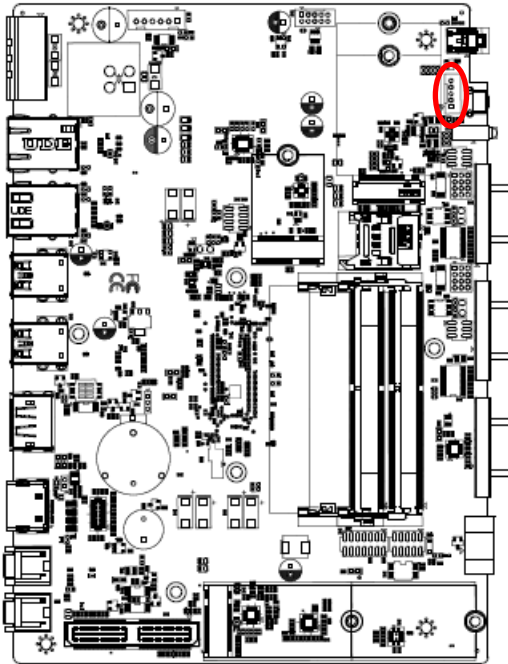

Signal	PIN
PWR_LED-	5
+5VSB	4
GND	3
PM_SYSRST#	2
PWRBTN_IN#	1

2.4.8 DC Output connector (DCOUT1)

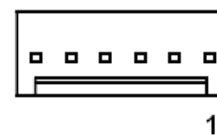
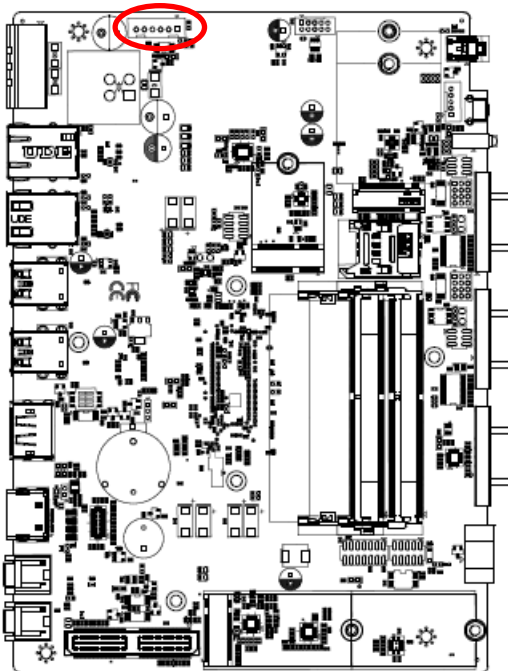

Signal	PIN
+VIN	1
+VIN	2
+VIN	3
GND	4
GND	5
GND	6

2.4.9 DC Input connector (JVIN1)

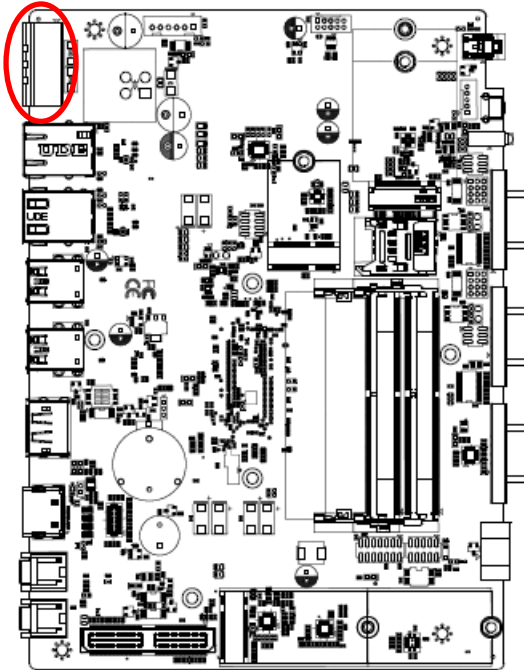

Signal	PIN
+DC_IN	1
CHASSIS_GND	2
GND	3

2.4.10 EC Debug connector (JEC_ROM1)

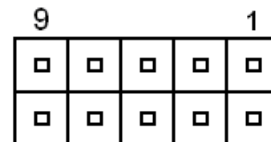
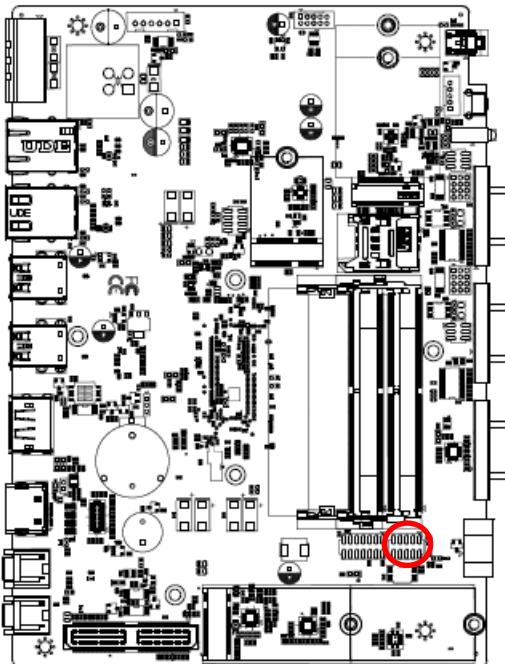

Signal	PIN	PIN	Signal
+VSPI_EC	1	2	GND
EC_FSCE#	3	4	EC_FSCK
EC_FMISO	5	6	EC_FMOSI
EC_HOLD#	7	8	NC
EC_SMCLK_DEBUG	9	10	EC_SMDAT_DEBUG

2.4.11 On-board header for USB2.0 (JUSB1)

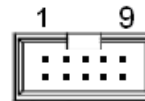
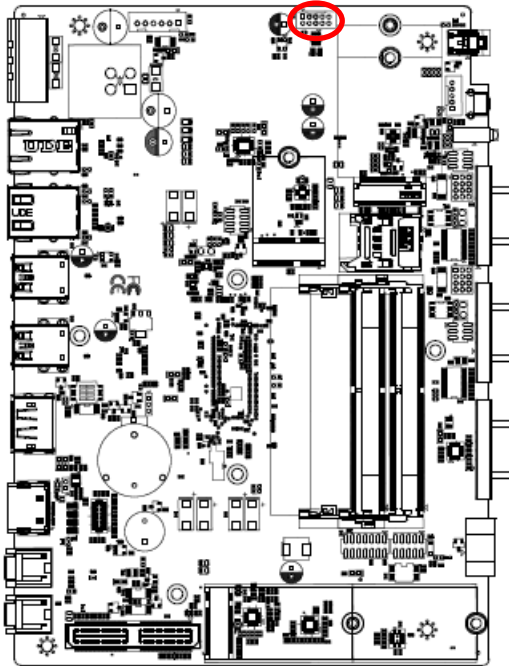

Signal	PIN	PIN	Signal
+5VSB	1	2	+5VSB
USB2_R_DN5	3	4	USB2_R_DN4
USB2_R_DP5	5	6	USB2_R_DP4
GND	7	8	GND
GND	9	10	GND

2.4.12 Power on/off connector (PWRBTN1)

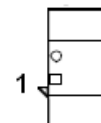
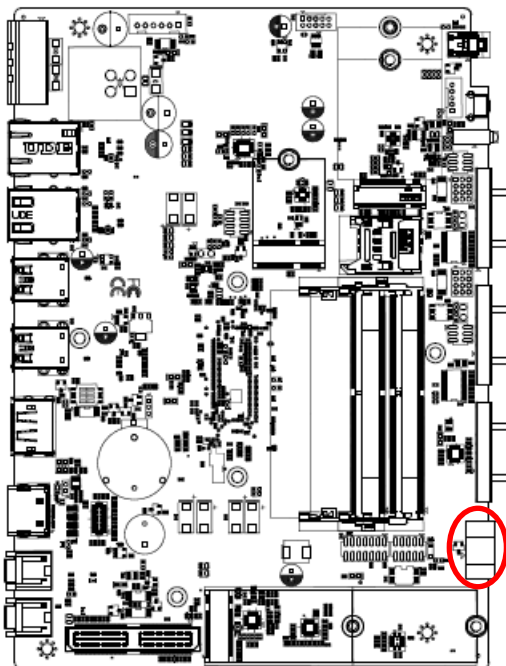

Signal	PIN
GND	2
PWRBTN#_R	1

2.5 EBM-TGLS, AUX-M01, IET-6 LAN Bypass, IET-6 LAN Normal, IET-PSEBF (4 port af), IET-PSEBT (2 port at), AUX-M07, EBM-BYTS DB-A, EBM-CDVS DB-A and EBM-BYTS DB-E Jumper & Connector list

2.5.1 AUX-M01

Jumpers

Label	Function	Note
JRI3/4/5/6	COM 3/4/5/6 pin 9 signal select	3 x 2 header, pitch 2.00mm

Connectors

Label	Function	Note
USB1~2	USB connector 1~2	
USB3	USB connector 3	5 x 1 wafer, pitch 2.00mm
JUSB3	USB connector 3	5 x 1 header, pitch 2.00mm
COM3~6	Serial port connector 3~6	

2.5.2 IET-6 LAN Bypass

Jumpers

Label	Function	Note
SW1	Normal/Bypass mode selector	

Connectors

Label	Function	Note
USB1~2	USB connector 1~2	
LAN1~4	LAN connector 1~4	
IET_CB1	IET Expansion slot	

2.5.3 IET-6 LAN Normal

Connectors

Label	Function	Note
USB1~2	USB connector 1~2	
USB3	USB connector 3	5 x 1 wafer, pitch 2.00mm
LAN1~4	LAN connector 1~4	
PWR1	Power connector	6 x 1 wafer, pitch 2.50mm
IET_CB1	IET Expansion slot	

2.5.4 IET-PSEBF (4 port af)

Connectors

Label	Function	Note
USB1~2	USB connector 1~2	
USB3	USB connector 3	5 x 1 wafer, pitch 2.00mm
LAN1~4	LAN connector 1~4	
PWR1	Power connector	6 x 1 wafer, pitch 2.50mm
IET_CB1	IET Expansion slot	

2.5.5 IET-PSEBT (2 port at)**Connectors**

Label	Function	Note
USB1~2	USB connector 1~2	
USB3	USB connector 3	5 x 1 wafer, pitch 2.00mm
LAN1~2	LAN connector 1~2	
PWR1	Power connector	6 x 1 wafer, pitch 2.50mm
IET_CB1	IET Expansion slot	

2.5.6 AUX-M07**Connectors**

Label	Function	Note
USB1~2	USB connector 1~2	
COM3~6	Serial port connector 3~6	

2.5.7 EBM-BYTS DB-A**Jumpers**

Label	Function	Note
OJRI3/4	COM 3/4 pin 9 signal select	3 x 2 header, pitch 2.00mm

Connectors

Label	Function	Note
OUSB1~2	USB connector 1~2	
LAN2~3	RJ-45 Ethernet 2~3	
COM3~4	Serial port connector 3~4	
HDMI1	HDMI connector	3 x 2 header, pitch 2.00mm
OJP485	Serial port 1/ 2 – RS485 mode select	6 x 2 header, pitch 2.00mm

EMS-TGL

2.5.8 EBM-CDVS DB-A

Connectors

Label	Function	Note
USB1~2	USB connector 1~2	
CN1	Front Panel connector 1	5 x 1 wafer, pitch 2.00 mm
DVI1	DVI connector	

2.5.9 EBM-BYTS DB-E

Connectors

Label	Function	Note
USB1~3	3 x USB2.0 connector	
USB4~7	4 x USB3.0 connector	

2.6 AUX-M01 Jumpers & Connectors settings

2.6.1 COM 3/4/5/6 pin 9 signal select (JR13/4/5/6)

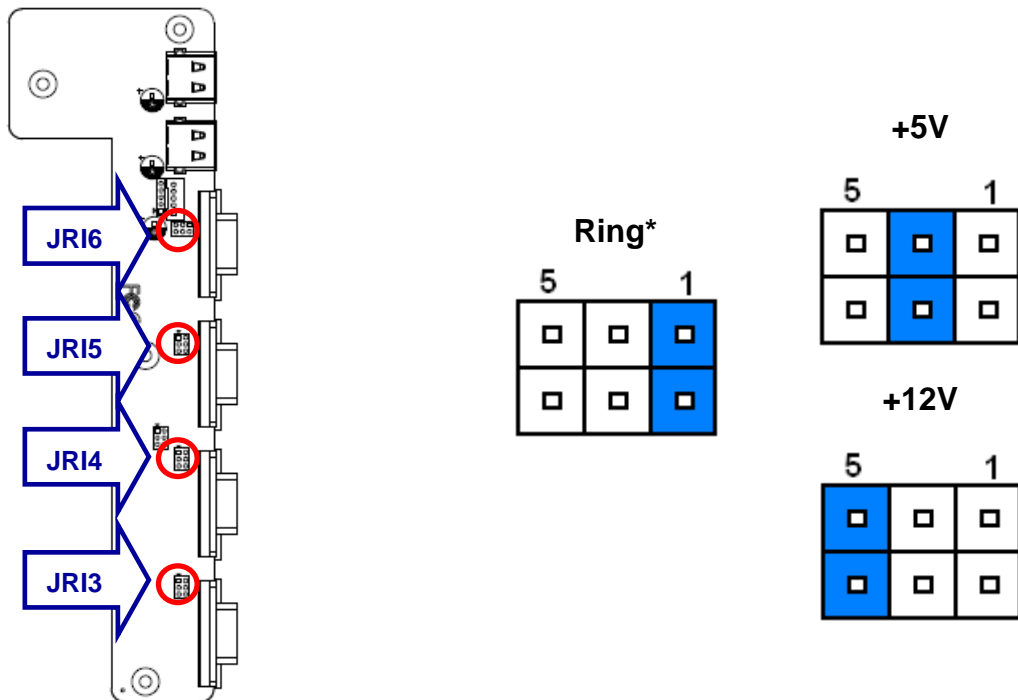

* Default

2.6.2 USB connector (USB3)

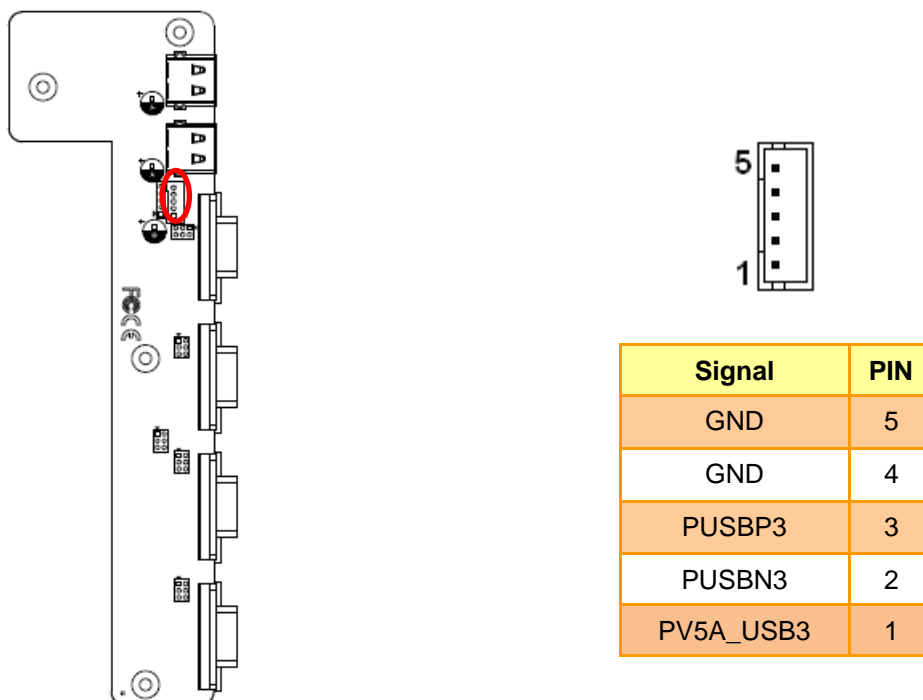

EMS-TGL

2.6.3 USB connector (JUSB3)

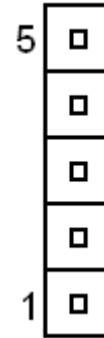
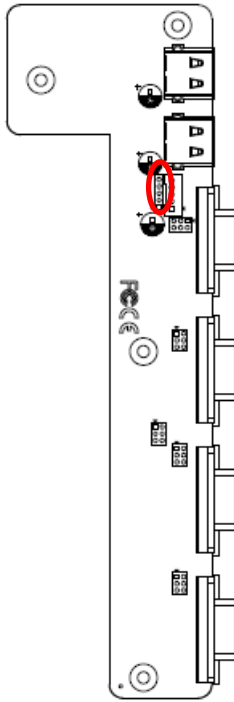

Signal	PIN
GND	5
GND	4
PUSBP3	3
PUSBN3	2
PV5A_USB3	1

2.6.4 SMBUS of TCA9555 address setting (PJP1)

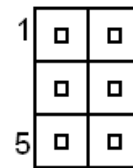
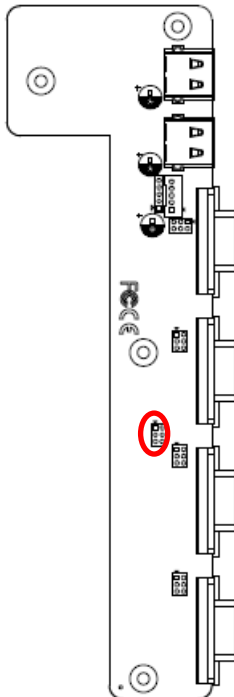

Signal	PIN	PIN	Signal
GND	1	2	MC_9555A0
GND	3	4	MC_9555A1
GND	5	6	MC_9555A2

2.7 IET-6 LAN Normal Connectors settings

2.7.1 USB connector 3 (USB3)

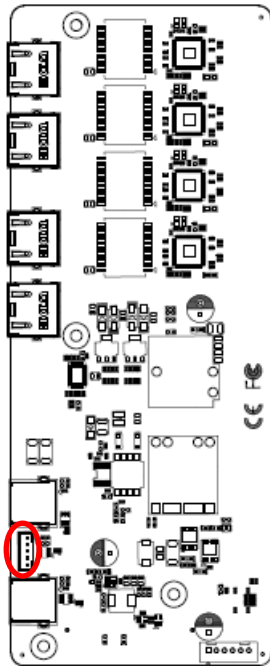

Signal	PIN
+5VSB	1
USB_DN_3	2
USB_DP_3	3
GND	4
GND	5

2.7.2 Power connector (PWR1)

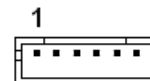
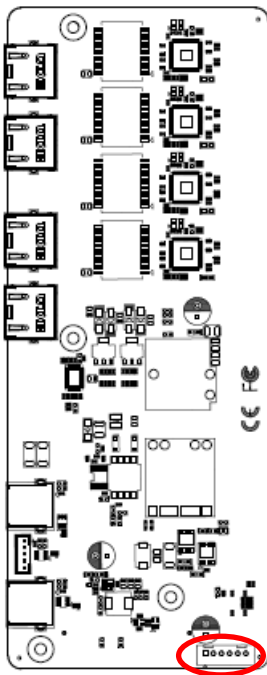

Signal	PIN
+V12-26V	1
+V12-26V	2
+V12-26V	3
GND	4
GND	5
GND	6

2.8 IET-PSEBF (4 port af) Jumpers & Connectors settings

2.8.1 USB connector 3 (USB3)

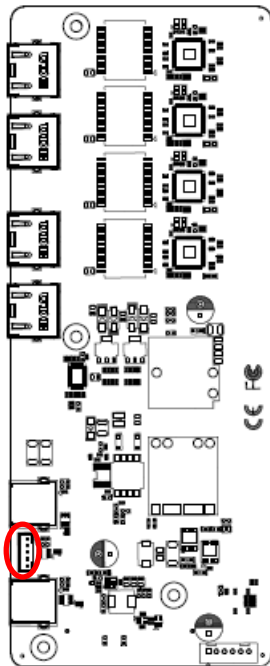

Signal	PIN
+5VSB	1
USB_DN_3	2
USB_DP_3	3
GND	4
GND	5

2.8.2 Power connector (PWR1)

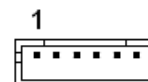
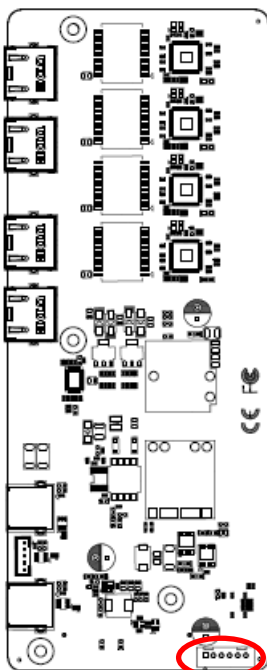

Signal	PIN
+V12-26V	1
+V12-26V	2
+V12-26V	3
GND	4
GND	5
GND	6

2.9 IET-PSEBT (2 port at) Jumpers & Connectors settings

2.9.1 USB connector 3 (USB3)

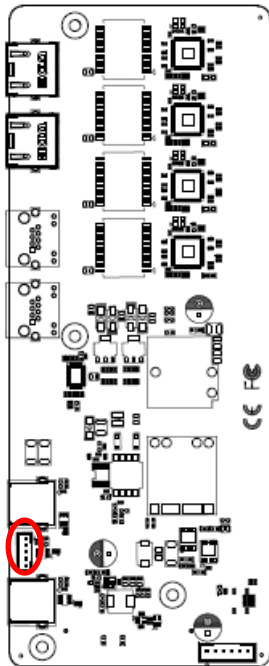

Signal	PIN
+5VSB	1
USB_DN_3	2
USB_DP_3	3
GND	4
GND	5

2.9.2 Power connector (PWR1)

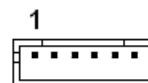
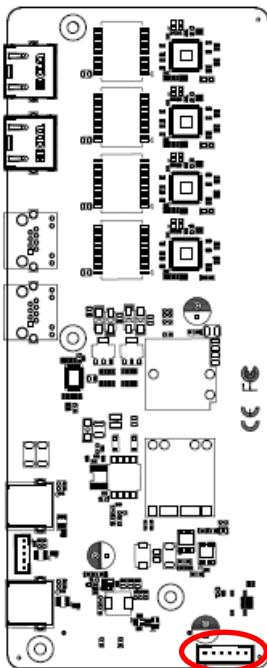

Signal	PIN
+V12-26V	1
+V12-26V	2
+V12-26V	3
GND	4
GND	5
GND	6

2.10 AUX-M07 Connector settings

2.10.1 SMBUS of TCA9555 address setting (SJP2)

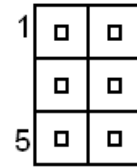
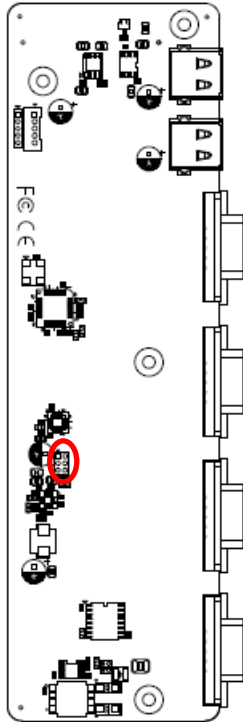

Signal	PIN	PIN	Signal
GND	1	2	SMC_9555A0
GND	3	4	SMC_9555A1
GND	5	6	SMC_9555A2

2.11 EBM-BYTS DB-A Jumpers & Connectors settings

2.11.1 COM 3/4 pin 9 signal select (OJRI3/4)

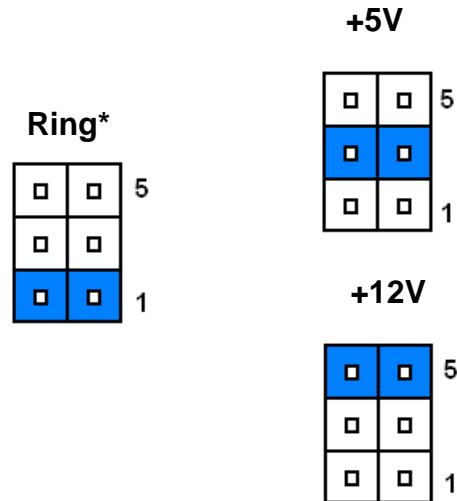
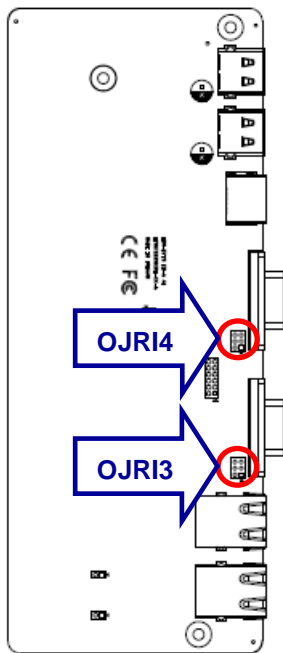

* Default

2.11.2 Serial port 1/ 2 – RS485 mode select (OJP485)

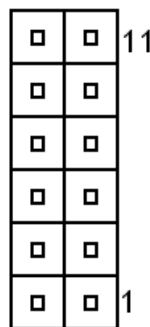
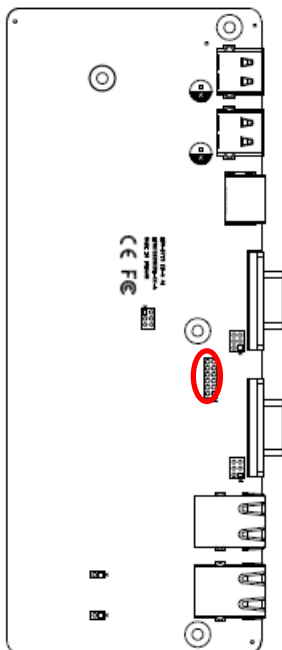

In Serial Port 1 mode

PIN	ON	NC
1-2	Auto Direction	RTS# Control*
3-4	485TXP external biasing resistor	OPEN*
5-6	485TXN external biasing resistor	OPEN*

In Serial Port 2 mode

	ON	NC
7-8	Auto Direction	RTS# Control*
9-10	485TXP external biasing resistor	OPEN*
11-12	485TXN external biasing resistor	OPEN*

2.11.3 SMBUS of TCA9555 address setting (OJP1)

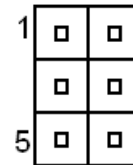
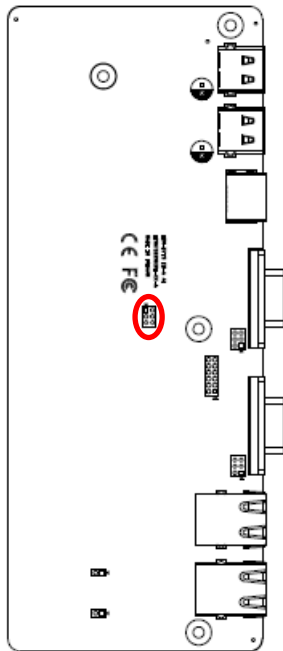

Signal	PIN	PIN	Signal
GND	1	2	MC_9555A0
GND	3	4	MC_9555A1
GND	5	6	MC_9555A2

2.12 EBM-CDVS DB-A Connector settings

2.12.1 Front Panel Connector 1 (CN1)

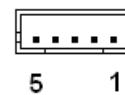
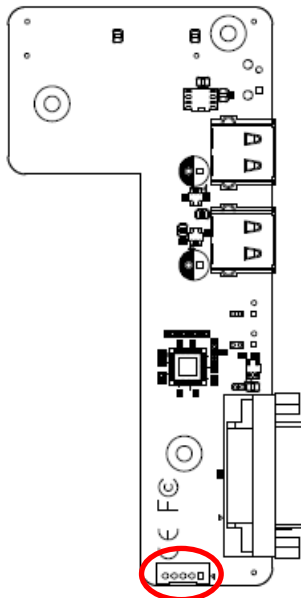

Signal	PIN
NC	1
SYSRST#	2
GND	3
SATA_LED#	4
PWRSB_LED-	5

2.13 Installing Hard Disk & Memory (EMS-TGL)

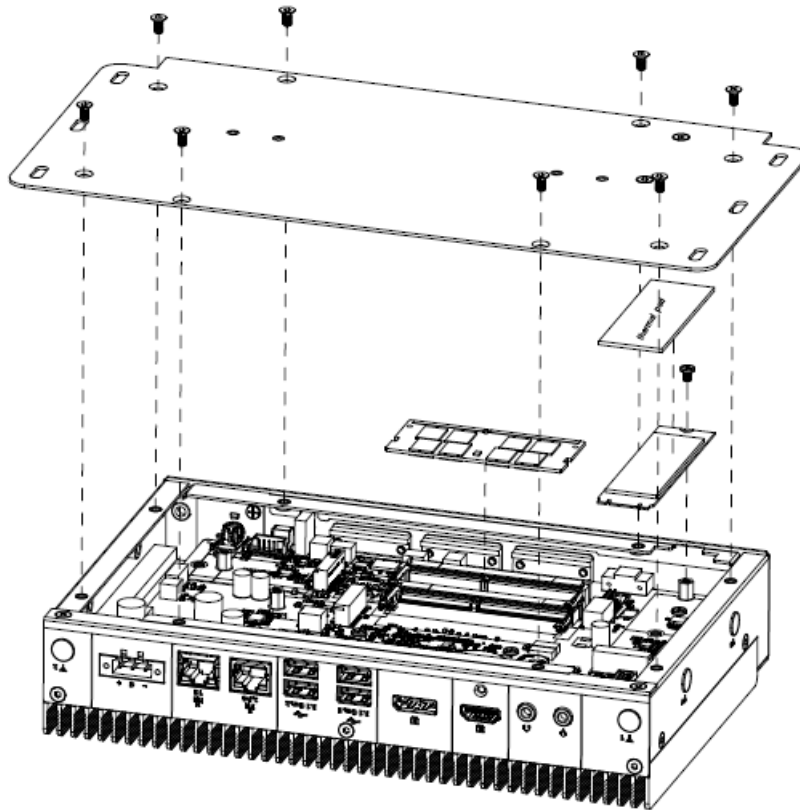

Step 1. Remove 8 screws from the bottom of your system and take it off.

Step 2. Slide the DDR4 SODIMM into the memory socket and press it down until properly seated.

Step 3. Insert M.2 M-Key card into designated locations, between M.2 and thermal solution please paste with thermal pad, and fasten with screws to complete installation.

3. BIOS Setup

3.1 Introduction

The BIOS setup program allows users to modify the basic system configuration. In this following chapter will describe how to access the BIOS setup program and the configuration options that may be changed.

3.2 Starting Setup

The AMI BIOS™ is immediately activated when you first power on the computer. The BIOS reads the system information contained in the NVRAM and begins the process of checking out the system and configuring it. When it finishes, the BIOS will seek an operating system on one of the disks and then launch and turn control over to the operating system.

While the BIOS is in control, the Setup program can be activated in one of two ways:

By pressing or <F2> immediately after switching the system on, or

By pressing the or <F2> key when the following message appears briefly at the left-top of the screen during the POST (Power On Self Test).

Press or <F2> to enter SETUP

If the message disappears before you respond and you still wish to enter Setup, restart the system to try again by turning it OFF then ON or pressing the "RESET" button on the system case. You may also restart by simultaneously pressing <Ctrl>, <Alt>, and <Delete> keys. If you do not press the keys at the correct time and the system does not boot, an error message will be displayed and you will again be asked to.

Press F1 to Continue, DEL to enter SETUP

3.3 Using Setup

In general, you use the arrow keys to highlight items, press <Enter> to select, use the PageUp and PageDown keys to change entries, press <F1> for help and press <Esc> to quit. The following table provides more detail about how to navigate in the Setup program using the keyboard.

Button	Description
↑	Move to previous item
↓	Move to next item
←	Move to the item in the left hand
→	Move to the item in the right hand
Esc key	Main Menu -- Quit and not save changes into NVRAM Status Page Setup Menu and Option Page Setup Menu -- Exit current page and return to Main Menu
+ key	Increase the numeric value or make changes
- key	Decrease the numeric value or make changes
F1 key	General help, only for Status Page Setup Menu and Option Page Setup Menu
F2 key	Previous Values.
F3 key	Optimized defaults
F4 key	Save & Exit Setup

- **Navigating Through The Menu Bar**

Use the left and right arrow keys to choose the menu you want to be in.



Note: Some of the navigation keys differ from one screen to another.

- **To Display a Sub Menu**

Use the arrow keys to move the cursor to the sub menu you want. Then press <Enter>. A “>” pointer marks all sub menus.

3.4 Getting Help

Press F1 to pop up a small help window that describes the appropriate keys to use and the possible selections for the highlighted item. To exit the Help Window press <Esc> or the F1 key again.

3.5 In Case of Problems

If, after making and saving system changes with Setup, you discover that your computer no longer is able to boot, the AMI BIOS supports an override to the NVRAM settings which resets your system to its defaults.

The best advice is to only alter settings which you thoroughly understand. To this end, we strongly recommend that you avoid making any changes to the chipset defaults. These defaults have been carefully chosen by both BIOS Vendor and your systems manufacturer to provide the absolute maximum performance and reliability. Even a seemingly small change to the chipset setup has the potential for causing you to use the override.

3.6 BIOS setup

Once you enter the Aptio Setup Utility, the Main Menu will appear on the screen. The Main Menu allows you to select from several setup functions and exit choices. Use the arrow keys to select among the items and press <Enter> to accept and enter the sub-menu.

3.6.1 Main Menu

This section allows you to record some basic hardware configurations in your computer and set the system clock.

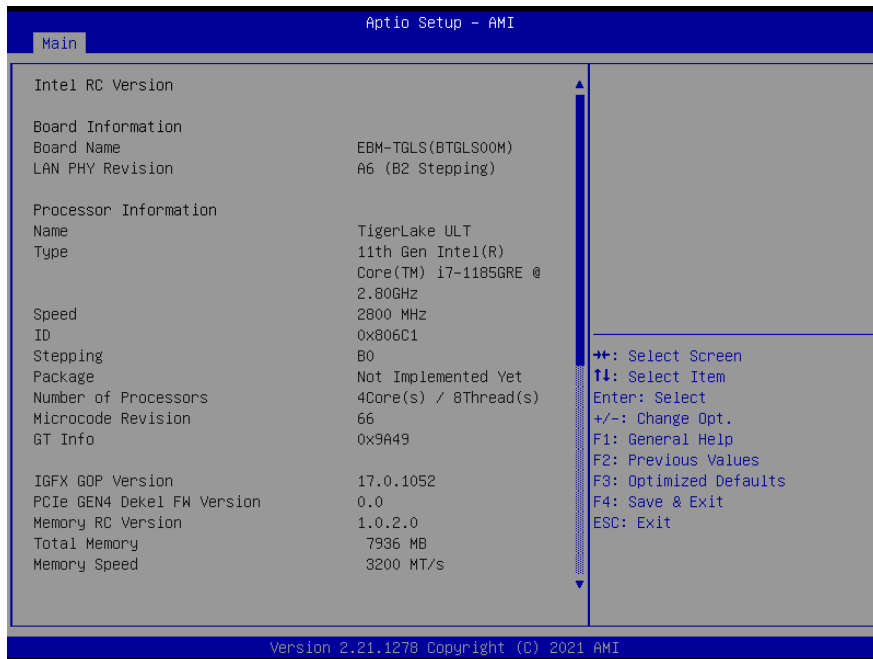
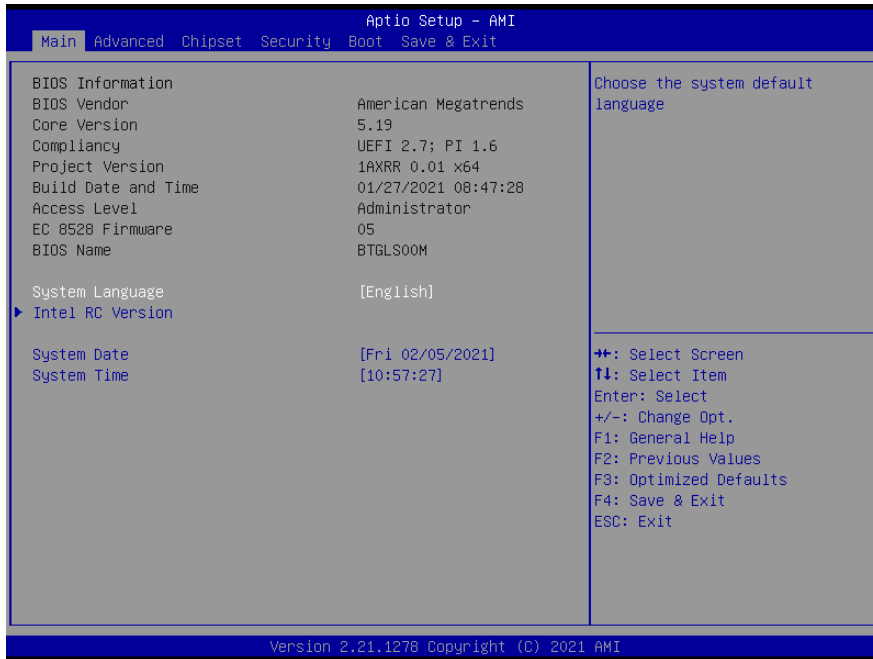

3.6.1.1 System Language

This option allows choosing the system default language.

3.6.1.2 System Date

Use the system date option to set the system date. Manually enter the day, month and year.

3.6.1.3 System Time

Use the system time option to set the system time. Manually enter the hours, minutes and seconds.



Note: The BIOS setup screens shown in this chapter are for reference purposes only, and may not exactly match what you see on your screen.

Visit the Avalue website (www.avalu.com.tw) to download the latest product and BIOS information.

3.6.2 Advanced Menu

This section allows you to configure your CPU and other system devices for basic operation through the following sub-menus.



3.6.2.1 CPU Configuration

Use the CPU configuration menu to view detailed CPU specification and configure the CPU.

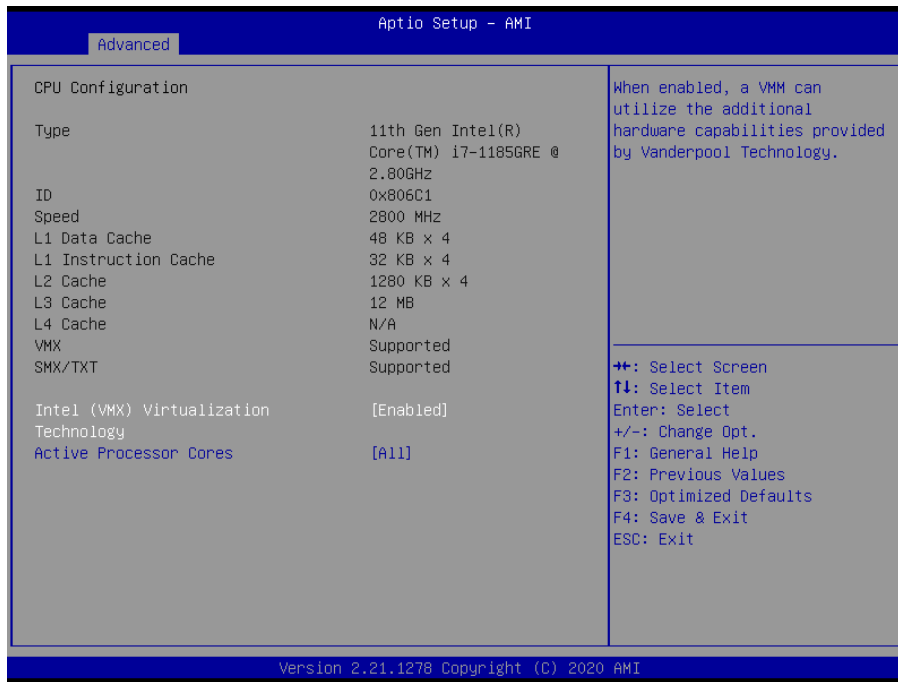

Item	Options	Description
Intel(VMX) Virtualization Technology	Disabled Enabled[Default]	When enabled, a VMM can utilize the additional hardware capabilities provided by Vanderpool Technology.
Active Processor Cores	All[Default] 1 2 3	Number of cores to enable in each processor package.

3.6.2.2 Power & Performance

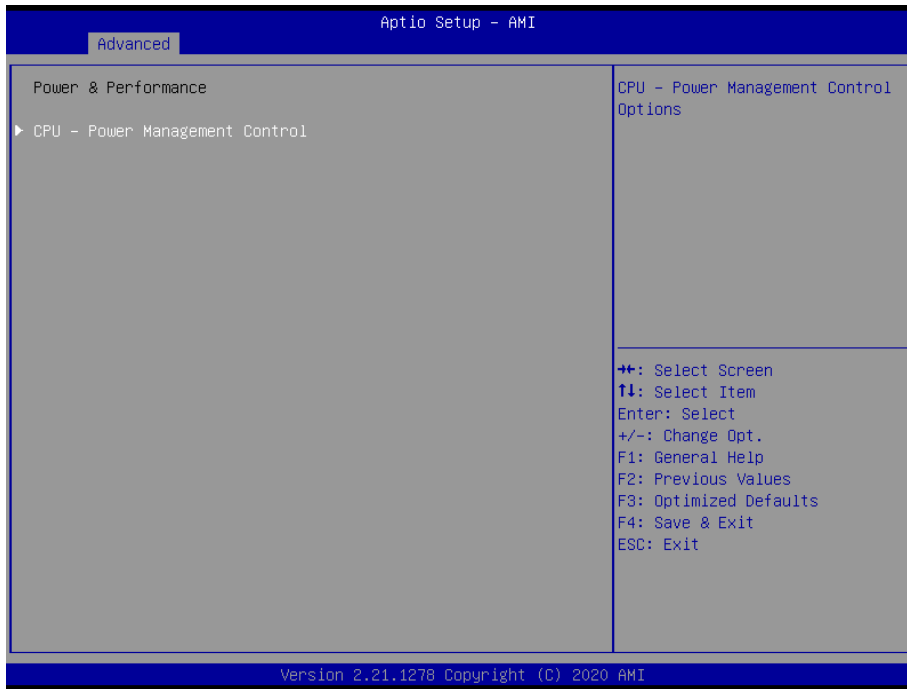

3.6.2.2.1 CPU-Power Management Control

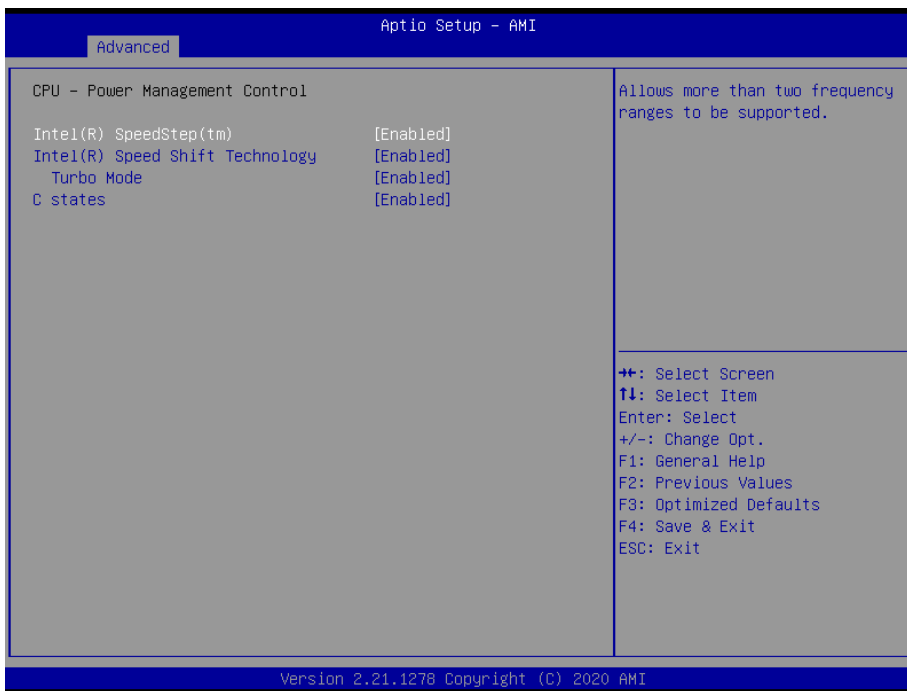

Item	Option	Description
Intel® SpeedSted™	Enabled[Default], Disabled	Allows more than two frequency ranges to be supported.
Intel® Speed Shift Technology	Enabled[Default], Disabled	Enable/Disable Intel® Speed Shift Technology support. Enabling will expose the CPPC v2 interface to allow for hardware controlled P-states.

EMS-TGL

Turbo Mode	Enabled[Default], Disabled	Enable/Disable processor Turbo Mode (requires EMTTM enabled too). AUTO means enabled.
C states	Enabled[Default], Disabled	Enable/Disable CPU Power Management. Allows CPU to go to C states when it's not 100% utilized.

3.6.2.3 PCH-FW Configuration

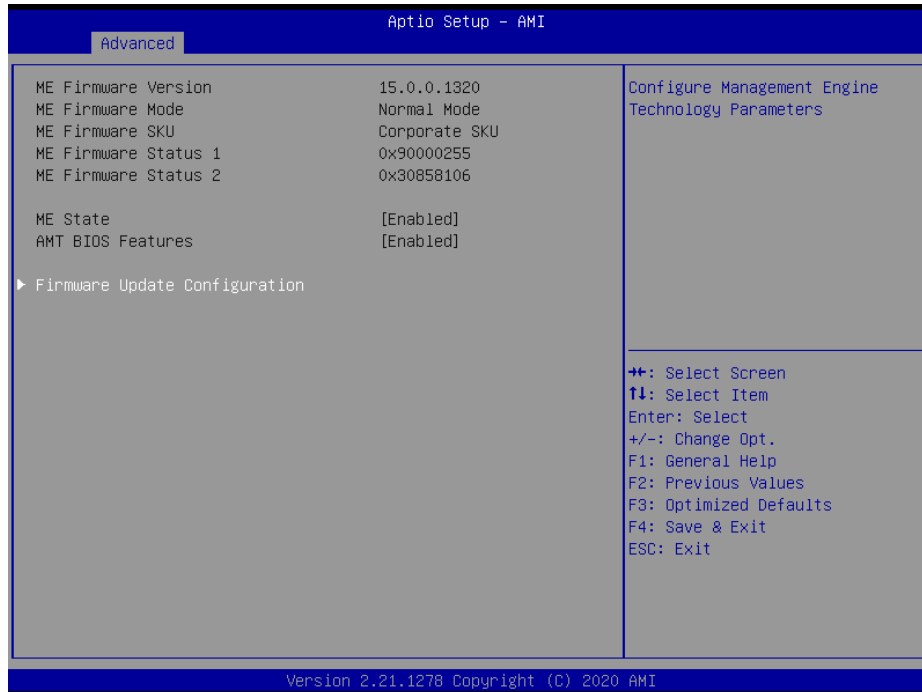

3.6.2.3.1 Firmware Update Configuration



Item	Option	Description
Me FW Image Re-Flash	Enabled Disabled[Default],	Enable/Disable Me FW Image Re-Flash function.

3.6.2.4 Trusted Computing



Item	Options	Description
Security Device Support	Disable Enable[Default]	Enables or Disables BIOS support for security device. O.S. will not show Security Device. TCG EFI protocol and INT1A interface will not be available.

3.6.2.5 APCI Settings



Item	Options	Description
Enable Hibernation	Disabled Enabled[Default],	Enables or Disables System ability to Hibernate (OS/S4 Sleep State). This option may be not effective with some OS.
ACPI Sleep State	Suspend Disabled, S3 (Suspend to RAM) [Default]	Select the highest ACPI sleep state the system will enter when the SUSPEND button is pressed.

3.6.2.6 IT8528 Super IO Configuration

You can use this item to set up or change the IT8528 Super IO configuration for serial ports. Please refer to 3.6.2.6.1~ 3.6.2.6.6 for more information.

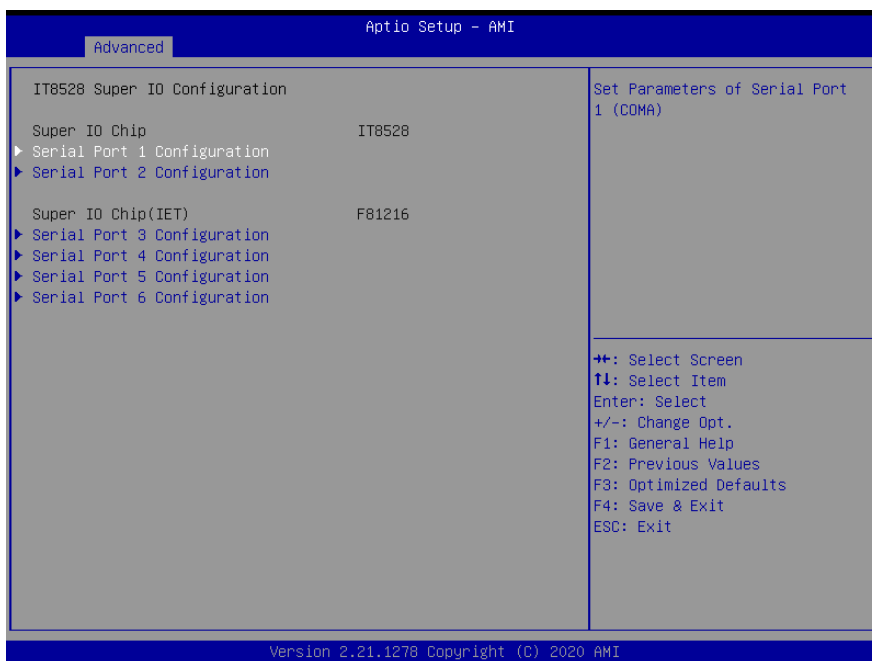

Item	Description
Serial Port 1 Configuration	Set Parameters of Serial Port 1 (COMA).
Serial Port 2 Configuration	Set Parameters of Serial Port 2 (COMB).
Serial Port 3 Configuration	Set Parameters of Serial Port 3 (COMC).
Serial Port 4 Configuration	Set Parameters of Serial Port 4 (COMD).
Serial Port 5 Configuration	Set Parameters of Serial Port 5 (COME).
Serial Port 6 Configuration	Set Parameters of Serial Port 5 (COMF).

3.6.2.6.1 Serial Port 1 Configuration

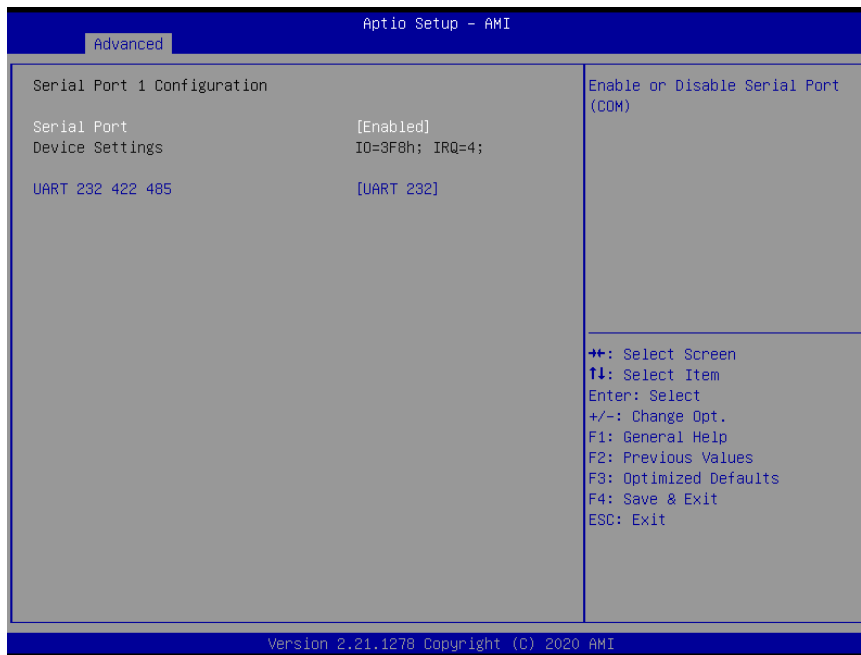

Item	Option	Description
Serial Port	Enabled[Default], Disabled	Enable or Disable Serial Port (COM).
UART 232 422 485	UART 232[Default] UART 422 UART 485	Change the Serial Port as RS232/422/485.

3.6.2.6.2 Serial Port 2 Configuration

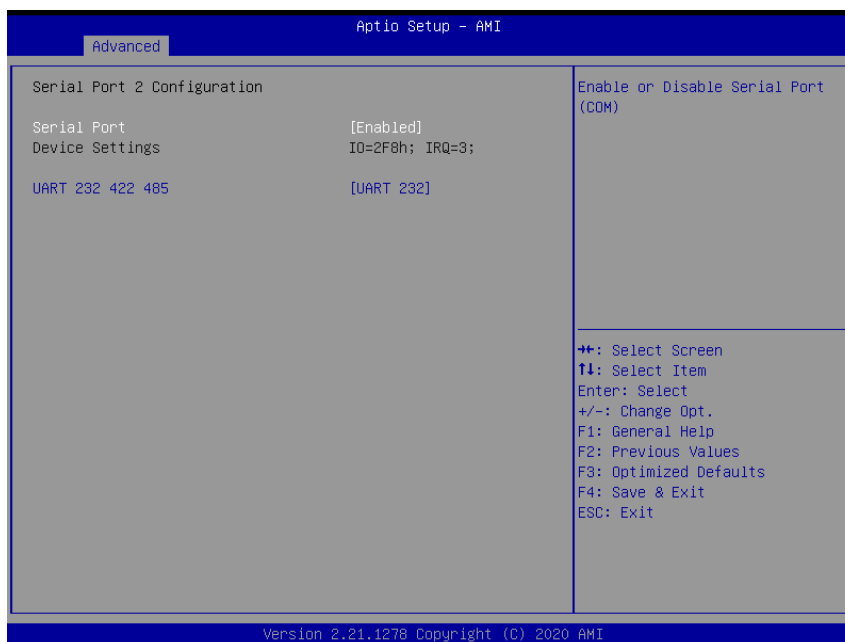

Item	Option	Description
Serial Port	Enabled[Default], Disabled	Enable or Disable Serial Port (COM).
UART 232 422 485	UART 232[Default] UART 422 UART 485	Change the Serial Port as RS232/422/485.

3.6.2.6.3 Serial Port 3 Configuration

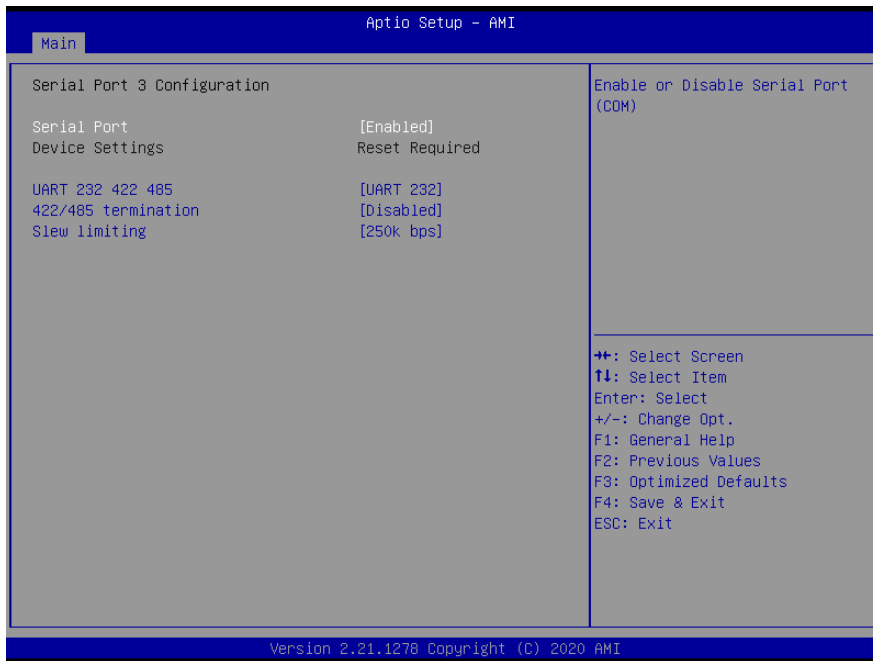

Item	Option	Description
Serial Port	Enabled[Default], Disabled	Enable or Disable Serial Port (COM).
UART 232 422 485	UART 232(LOOPBACK) UART 232[Default] UART 422 UART 485	Change the Serial Port as RS232/422/485.
422/485 termination	Enabled, Disabled[Default]	TERM from GPIO.
Slew limiting	10M bps 250k bps[Default]	SLEW from GPIO.

3.6.2.6.4 Serial Port 4 Configuration

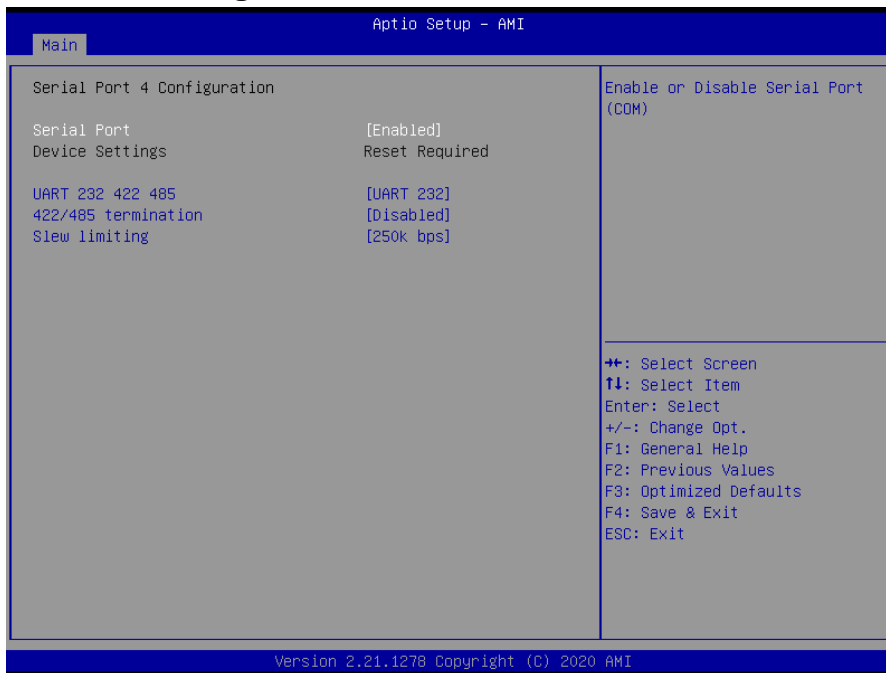

Item	Option	Description
Serial Port	Enabled[Default], Disabled	Enable or Disable Serial Port (COM).
UART 232 422 485	UART 232(LOOPBACK) UART 232[Default] UART 422 UART 485	Change the Serial Port as RS232/422/485.
422/485 termination	Enabled, Disabled[Default]	TERM from GPIO.
Slew limiting	10M bps 250k bps[Default]	SLEW from GPIO.

3.6.2.6.5 Serial Port 5 Configuration

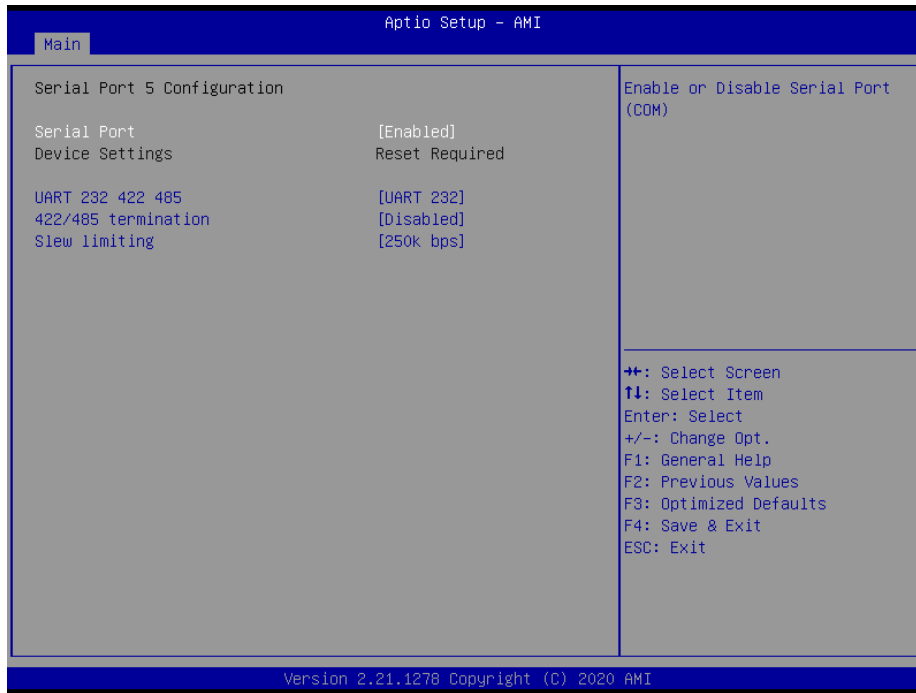

Item	Option	Description
Serial Port	Enabled[Default], Disabled	Enable or Disable Serial Port (COM).
UART 232 422 485	UART 232(LOOPBACK) UART 232[Default] UART 422 UART 485	Change the Serial Port as RS232/422/485.
422/485 termination	Enabled, Disabled[Default]	TERM from GPIO.
Slew limiting	10M bps 250k bps[Default]	SLEW from GPIO.

3.6.2.6.6 Serial Port 6 Configuration

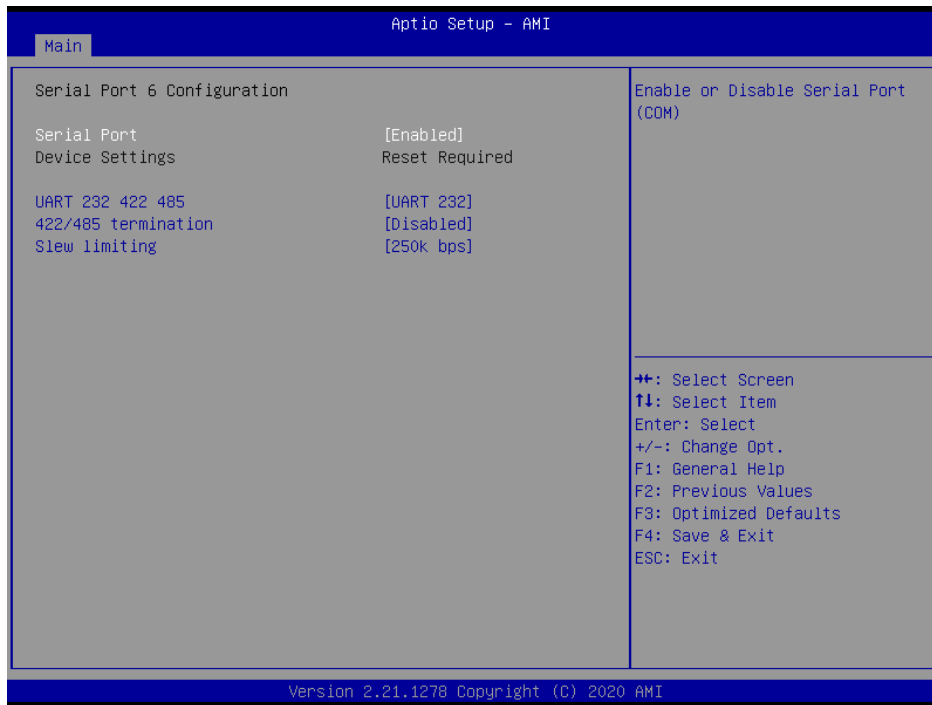

Item	Option	Description
Serial Port	Enabled[Default], Disabled	Enable or Disable Serial Port (COM).
UART 232 422 485	UART 232(LOOPBACK) UART 232[Default] UART 422 UART 485	Change the Serial Port as RS232/422/485.
422/485 termination	Enabled, Disabled[Default]	TERM from GPIO.
Slew limiting	10M bps 250k bps[Default]	SLEW from GPIO.

3.6.2.7 H/W Monitor

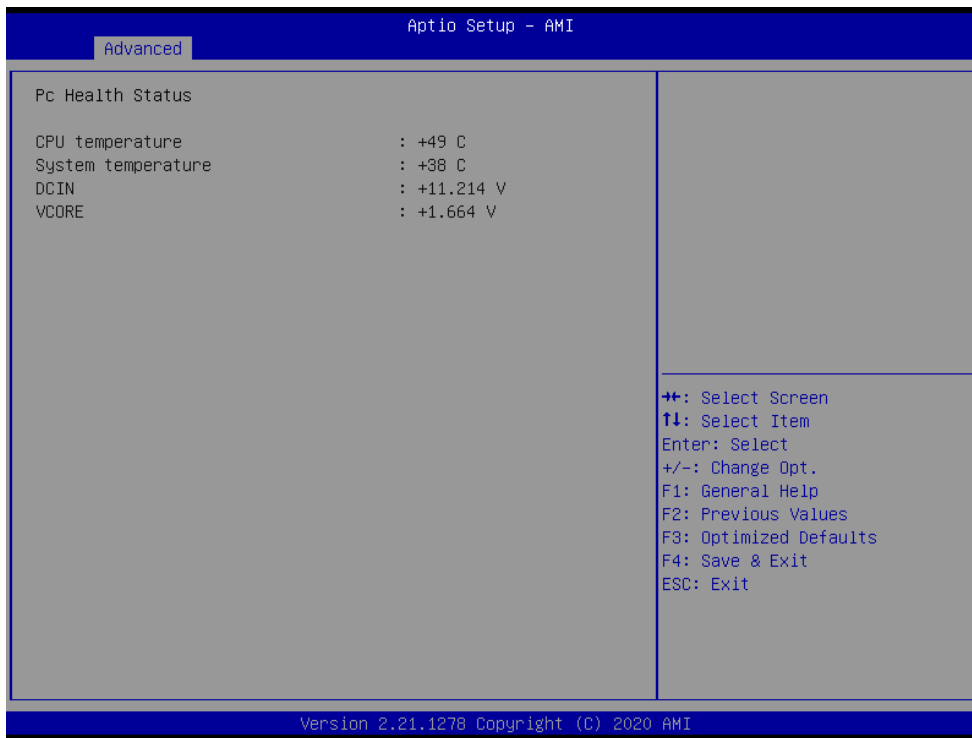

3.6.2.8 S5 RTC Wake Settings



Item	Options	Description
Wake system from S5	Disabled[Default], Fixed Time Dynamic Time	Enable or disable System wake on alarm event. Select Fixed Time, system will wake on the hr::min::sec specified. Select Dynamic Time, System will wake on the current time + Increase minute(s).

3.6.2.9 Serial Port Console Redirection

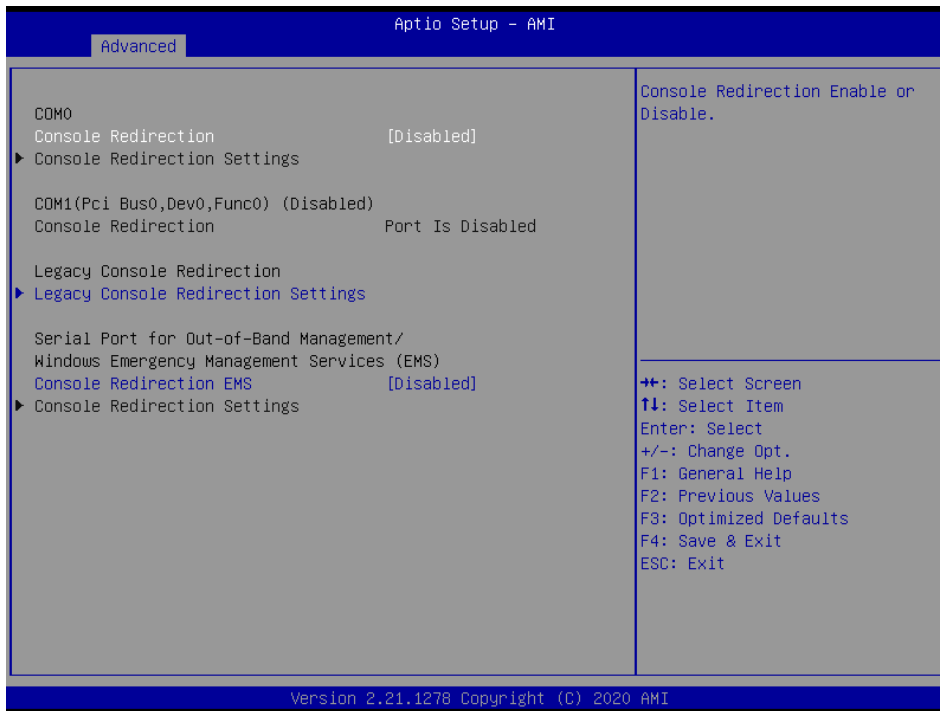

Item	Options	Description
Console Redirection	Disabled[Default], Enabled	Console Redirection Enable or Disable.
Console Redirection EMS	Disabled[Default], Enabled	Console Redirection Enable or Disable.

3.6.2.9.1 Legacy Console Redirection Settings



Item	Option	Description
Redirection COM Port	COM0[Default],	Select a COM port to display redirection of Legacy OS and Legacy OPROM Messages.

3.6.2.10 USB Configuration

The USB Configuration menu helps read USB information and configures USB settings.

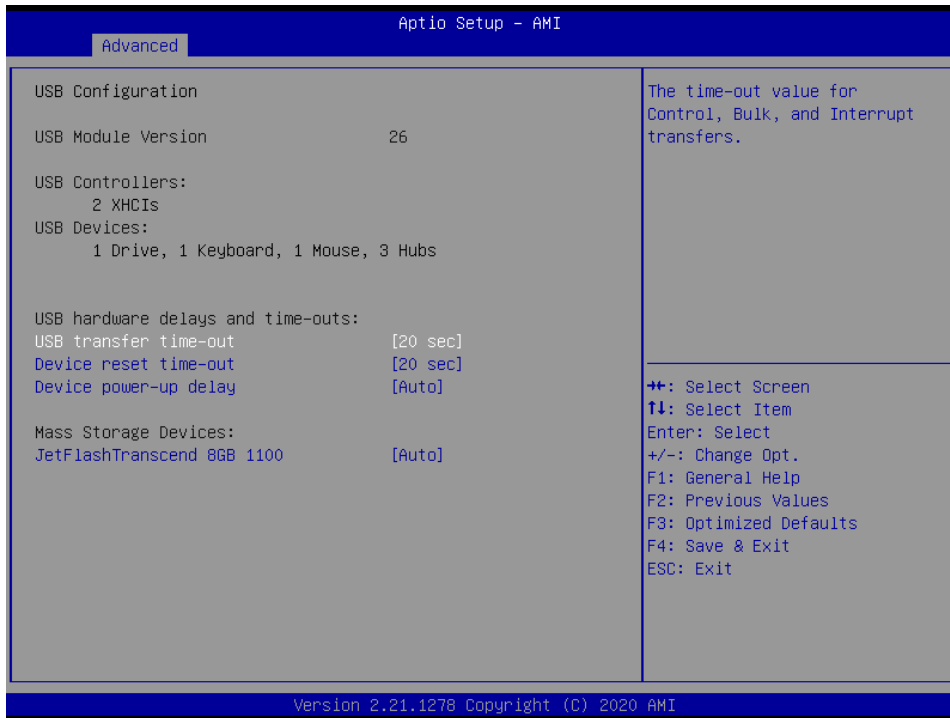

Item	Options	Description
USB transfer time-out	1 sec 5 sec 10 sec 20 sec[Default]	The time-out value for Control, Bulk, and Interrupt transfers.
Device reset time-out	10 sec 20 sec[Default] 30 sec 40 sec	USB mass storage device Start Unit command time-out.
Device power-up delay	Auto[Default] Manual	Maximum time the device will take before it properly reports itself to the Host Controller. 'Auto' uses default value: for a Root port it is 100ms, for a Hub port the delay is taken from Hub descriptor.
JetFlashTranscend 8GB 1100	Auto[Default] Floppy Forced FDD Hard Disk CD-ROM	Mass storage device emulation type. 'AUTO' enumerates devices according to their media format. Optical drives are emulated as 'CDROM', drives with no media will be emulated according to a drive type.

3.6.2.11 Network Stack Configuration



Item	Options	Description
Network Stack	Enabled Disabled[Default]	Enable/Disable UEFI Network Stack.

3.6.2.12 NVMe Configuration



3.6.3 Chipset

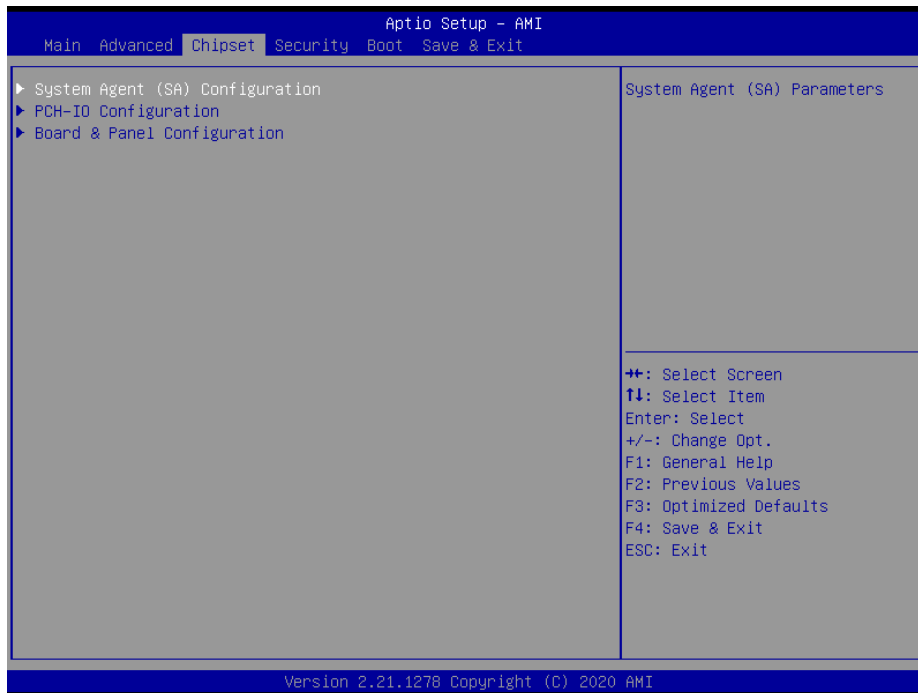

3.6.3.1 System Agent (SA) Configuration



Item	Option	Description
VT-d	Enabled[Default] Disabled	VT-d capability.

3.6.3.1.1 Memory Configuration

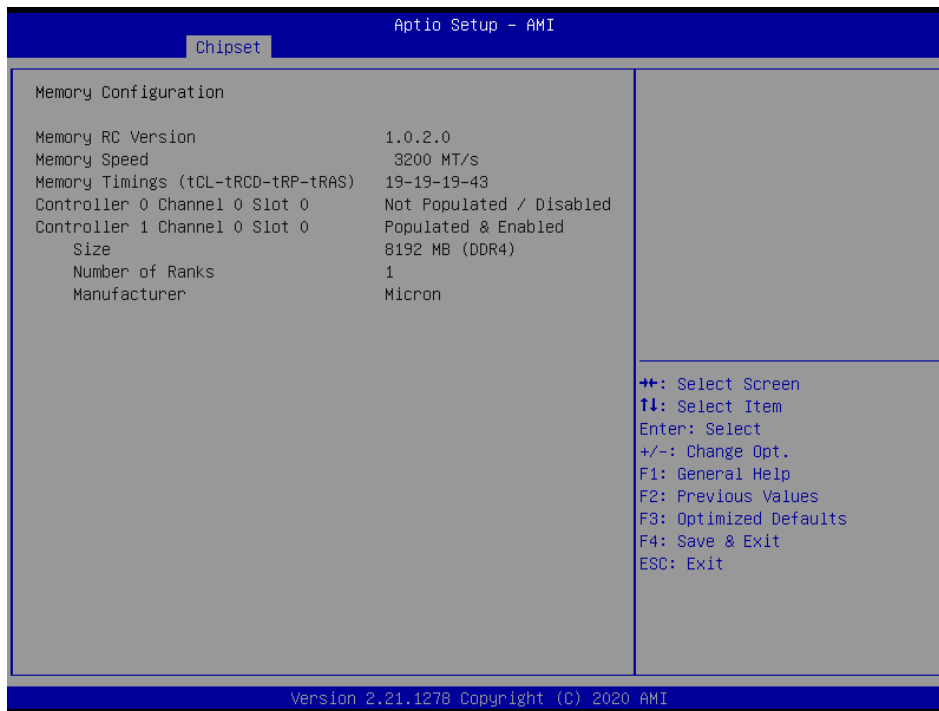

3.6.3.1.2 Graphics Configuration



Item	Option	Description
Primary Display	Auto[Default] IGFX	Select which of IGFX/PEG/PCI Graphics device should be Primary Display Or select HG for Hybrid Gfx.

3.6.3.2 PCH-IO Configuration

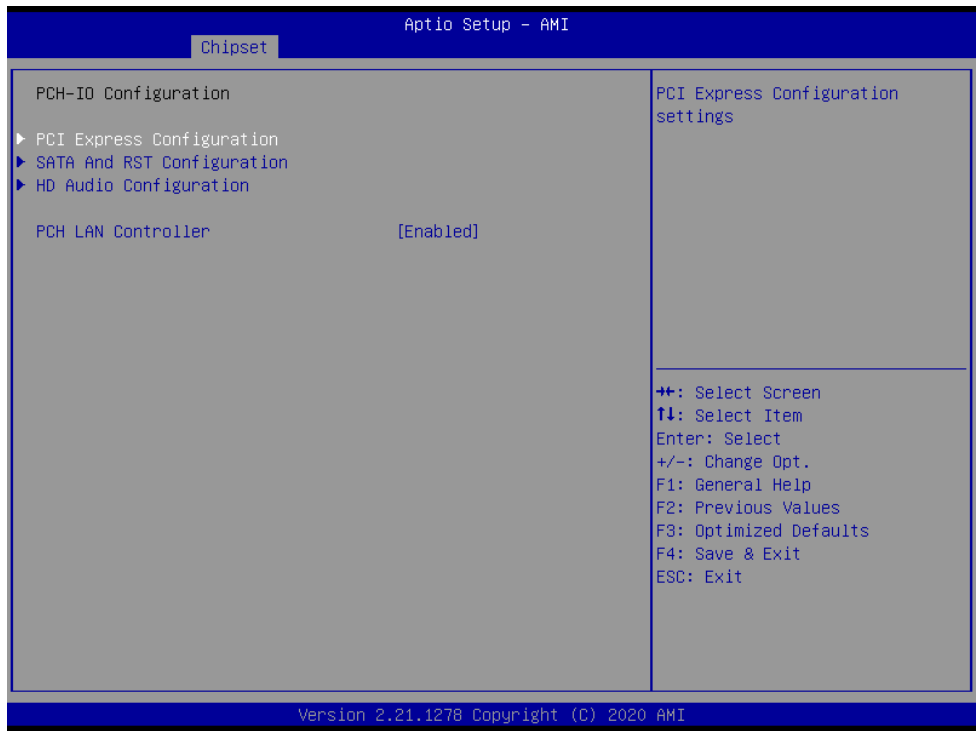

Item	Option	Description
PCH LAN Controller	Disabled Enabled[Default]	Enable or disable onboard NIC.

3.6.3.2.1 PCI Express Configuration

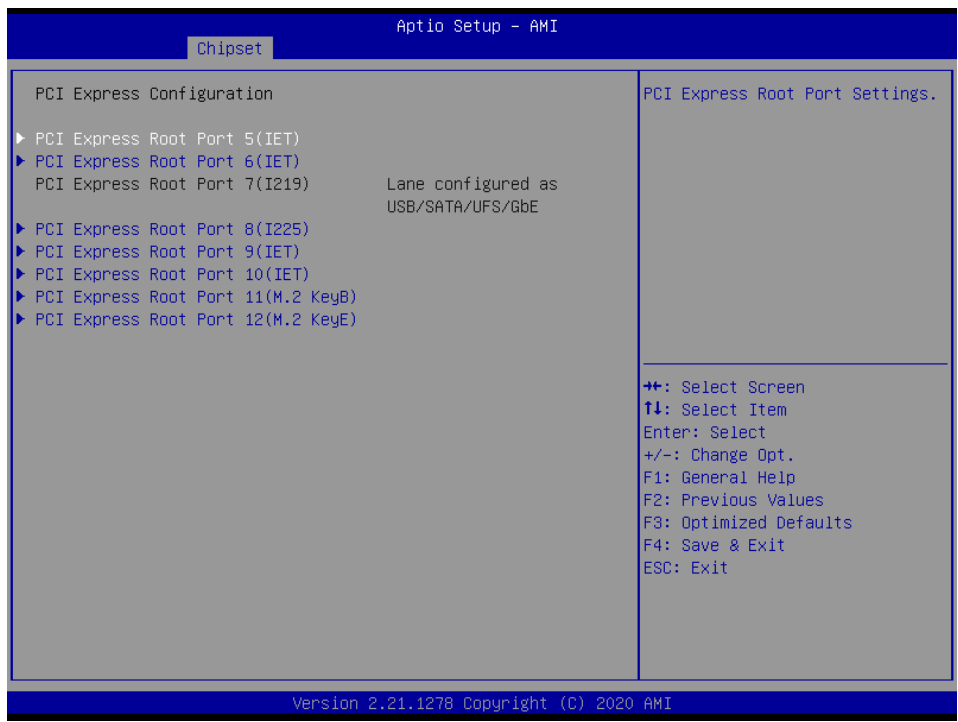

3.6.3.2.1.1 PCI Express Root Port 5 (IET)

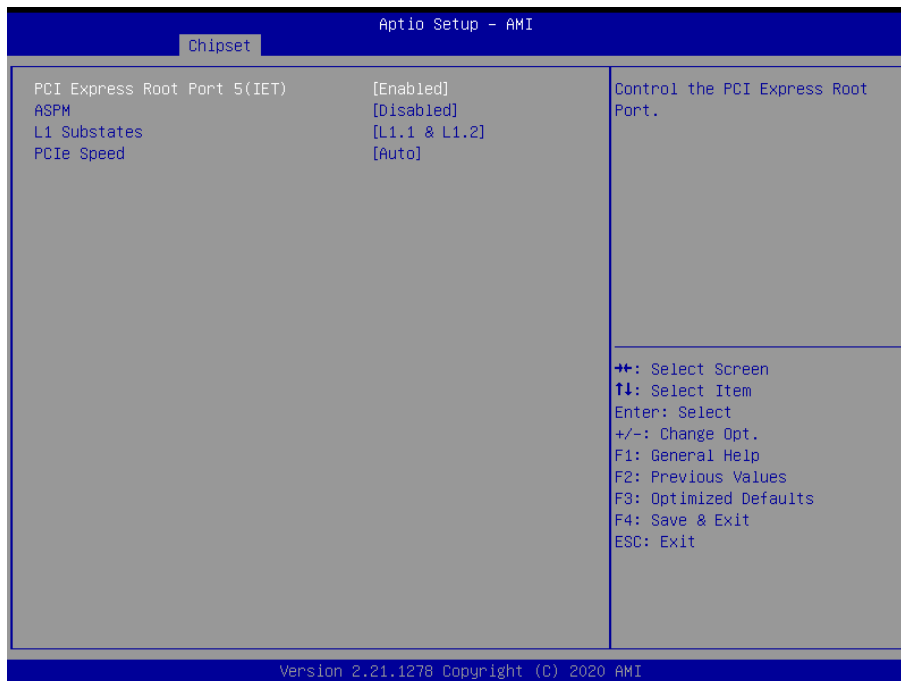

Item	Option	Description
PCI Express Root Port 5(IET)	Enabled[Default], Disabled	Control the PCI Express Root Port.
ASPM	Disabled[Default] L0s L1 L0sL1 Auto	Set the ASPM Level: Force L0s – Force all links to L0s State AUTO – BIOS auto configure DISABLE – Disables ASPM.
L1 Substates	Disabled L1.1 L1.1 & L1.2[Default],	PCI Express L1 Substates settings.
PCIe Speed	Auto[Default] Gen1 Gen2 Gen3	Configure PCIe speed.

3.6.3.2.1.2 PCI Express Root Port 6 (IET)

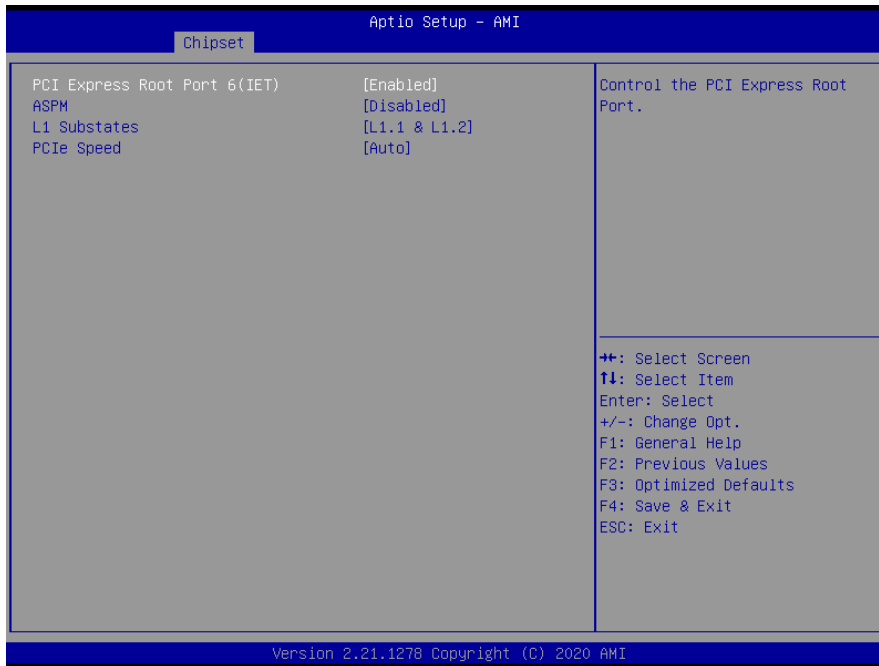

Item	Option	Description
PCI Express Root Port 6(IET)	Enabled[Default], Disabled	Control the PCI Express Root Port.
ASPM	Disabled[Default] L0s L1 L0sL1 Auto	Set the ASPM Level: Force L0s – Force all links to L0s State AUTO – BIOS auto configure DISABLE – Disables ASPM.
L1 Substates	Disabled L1.1 L1.1 & L1.2[Default],	PCI Express L1 Substates settings.
PCIe Speed	Auto[Default] Gen1 Gen2 Gen3	Configure PCIe speed.

3.6.3.2.1.3 PCI Express Root Port 8 (I225)

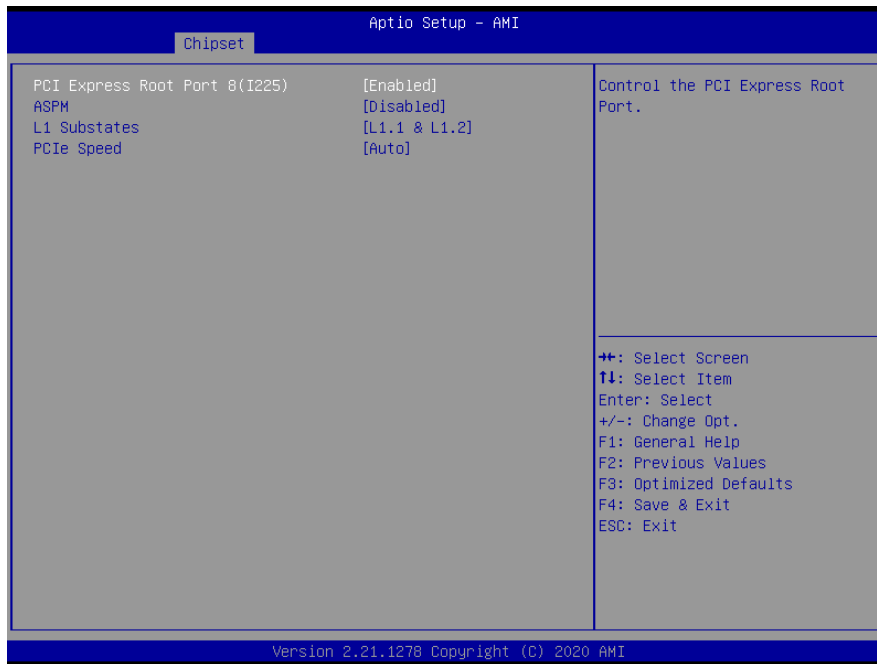

Item	Option	Description
PCI Express Root Port 8(I225)	Enabled[Default], Disabled	Control the PCI Express Root Port.
ASPM	Disabled[Default] L0s L1 L0sL1 Auto	Set the ASPM Level: Force L0s – Force all links to L0s State AUTO – BIOS auto configure DISABLE – Disables ASPM.
L1 Substates	Disabled L1.1 L1.1 & L1.2[Default],	PCI Express L1 Substates settings.
PCIe Speed	Auto[Default] Gen1 Gen2 Gen3	Configure PCIe speed.

3.6.3.2.1.4 PCI Express Root Port 9 (IET)

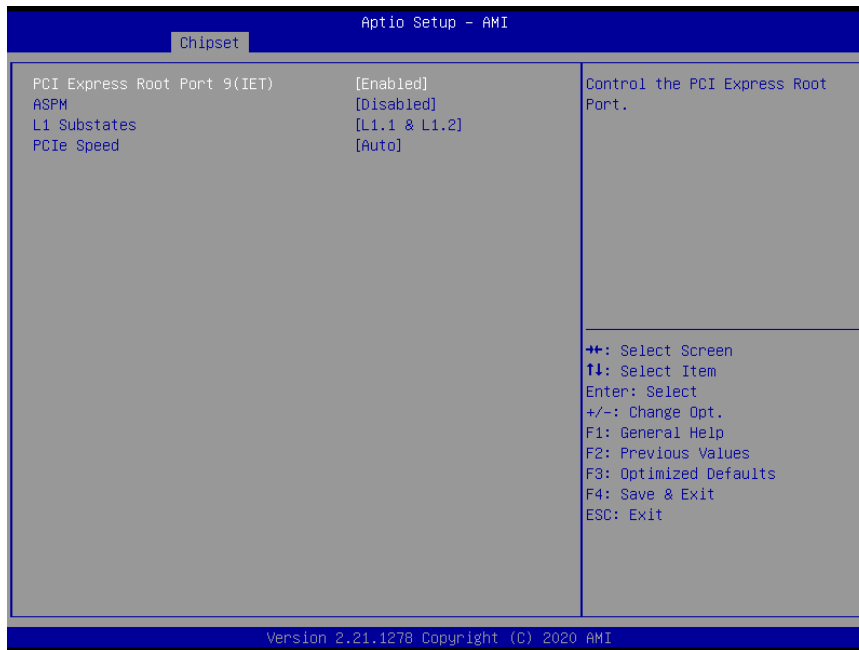

Item	Option	Description
PCI Express Root Port 9(IET)	Enabled[Default], Disabled	Control the PCI Express Root Port.
ASPM	Disabled[Default] L0s L1 L0sL1 Auto	Set the ASPM Level: Force L0s – Force all links to L0s State AUTO – BIOS auto configure DISABLE – Disables ASPM.
L1 Substates	Disabled L1.1 L1.1 & L1.2[Default],	PCI Express L1 Substates settings.
PCIe Speed	Auto[Default] Gen1 Gen2 Gen3	Configure PCIe speed.

3.6.3.2.1.5 PCI Express Root Port 10 (IET)

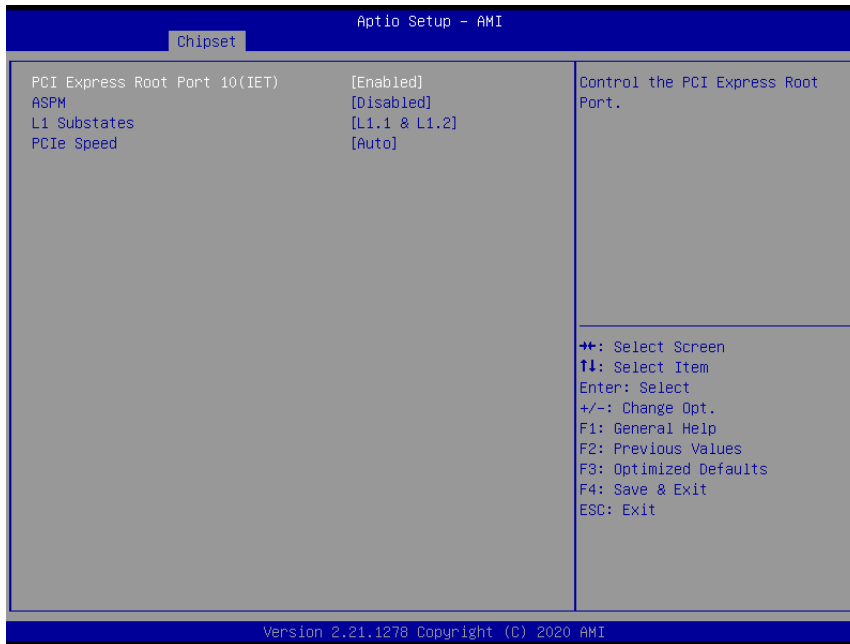

Item	Option	Description
PCI Express Root Port 10(IET)	Enabled[Default], Disabled	Control the PCI Express Root Port.
ASPM	Disabled[Default] L0s L1 L0sL1 Auto	Set the ASPM Level: Force L0s – Force all links to L0s State AUTO – BIOS auto configure DISABLE – Disables ASPM.
L1 Substates	Disabled L1.1 L1.1 & L1.2[Default],	PCI Express L1 Substates settings.
PCIe Speed	Auto[Default] Gen1 Gen2 Gen3	Configure PCIe speed.

3.6.3.2.1.6 PCI Express Root Port 11 (M.2 KeyB)

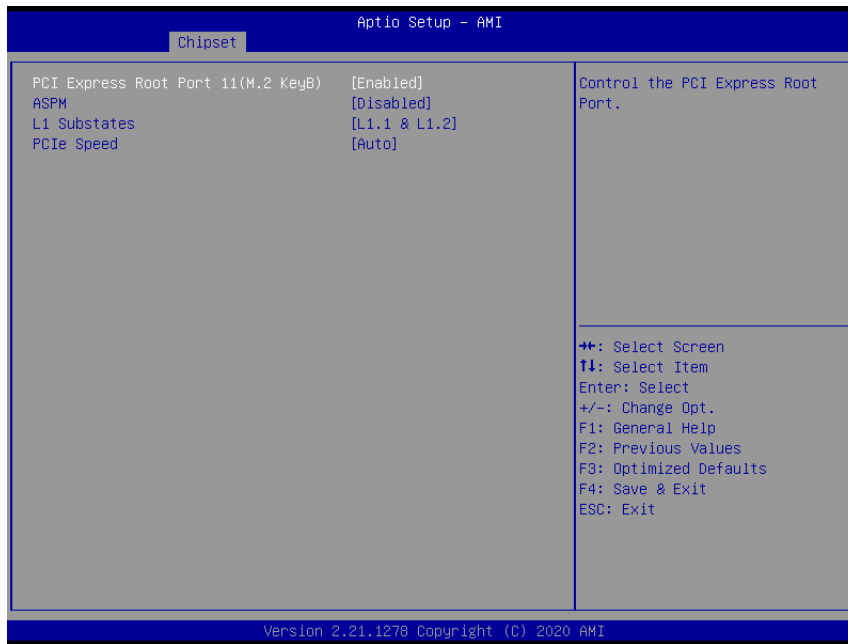

Item	Option	Description
PCI Express Root Port 11 (M.2 KeyB)	Enabled[Default], Disabled	Control the PCI Express Root Port.
ASPM	Disabled[Default] L0s L1 L0sL1 Auto	Set the ASPM Level: Force L0s – Force all links to L0s State AUTO – BIOS auto configure DISABLE – Disables ASPM.
L1 Substates	Disabled L1.1 L1.1 & L1.2[Default],	PCI Express L1 Substates settings.
PCIe Speed	Auto[Default] Gen1 Gen2 Gen3	Configure PCIe speed.

3.6.3.2.1.7 PCI Express Root Port 12 (M.2 KeyE)

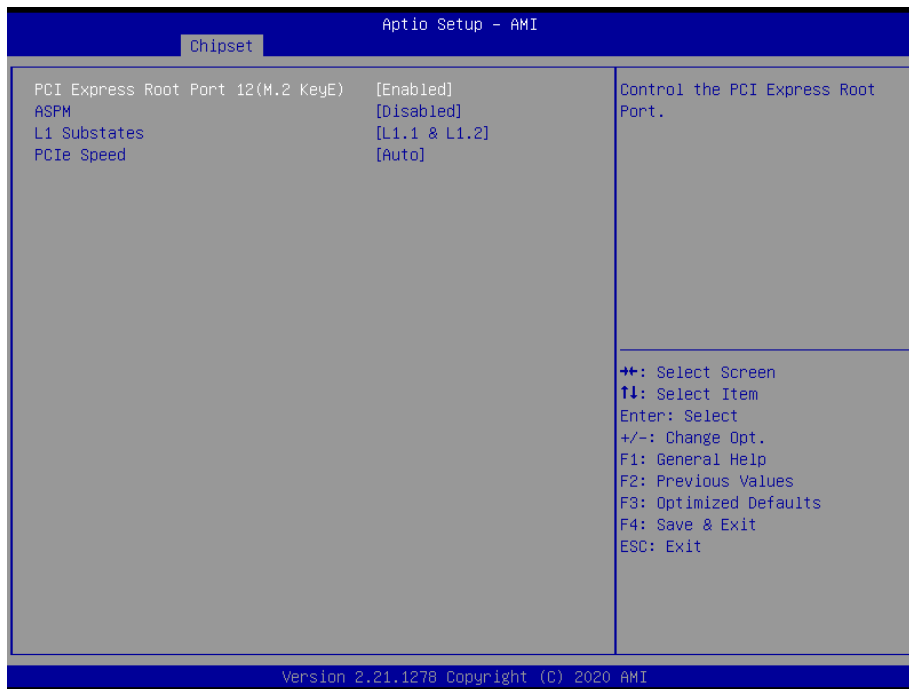

Item	Option	Description
PCI Express Root Port 12 (M.2 KeyE)	Enabled[Default], Disabled	Control the PCI Express Root Port.
ASPM	Disabled[Default] L0s L1 L0sL1 Auto	Set the ASPM Level: Force L0s – Force all links to L0s State AUTO – BIOS auto configure DISABLE – Disables ASPM.
L1 Substates	Disabled L1.1 L1.1 & L1.2[Default],	PCI Express L1 Substates settings.
PCIe Speed	Auto[Default] Gen1 Gen2 Gen3	Configure PCIe speed.

3.6.3.2.2 SATA And RST Configuration

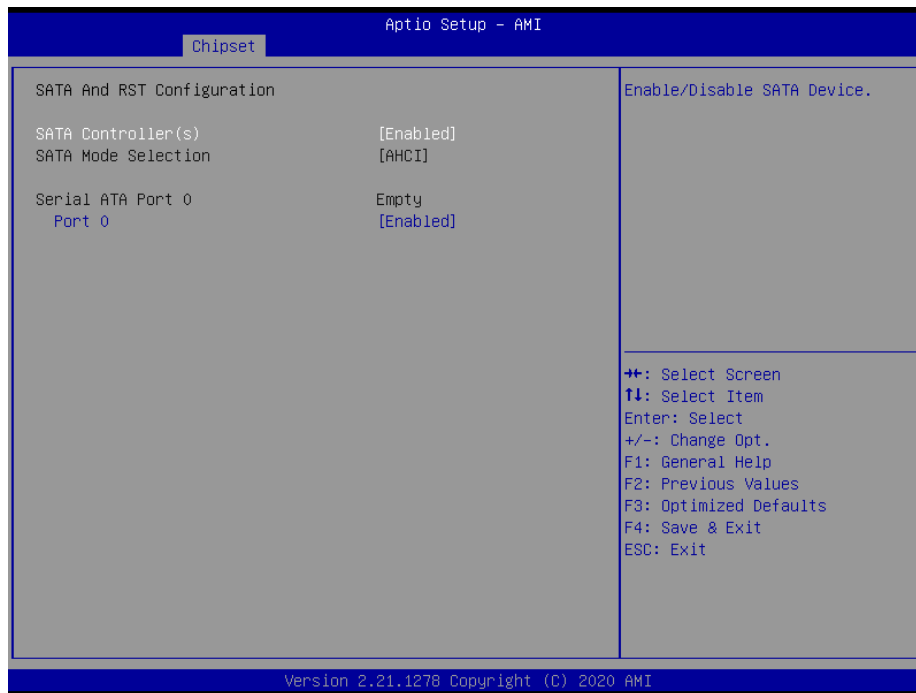

Item	Option	Description
SATA Controller(s)	Enabled[Default] Disabled,	Enable/Disable SATA Device.
Port 0	Enabled[Default] Disabled,	Enable or Disable SATA Port.

3.6.3.2.3 HD Audio Configuration



Item	Option	Description
HD Audio	Disabled Enabled[Default],	Control Detection of the HD-Audio device. Disable = HDA will be unconditionally disabled Enabled = HDA will be unconditionally enabled.

3.6.3.2 Board & Panel Configuration

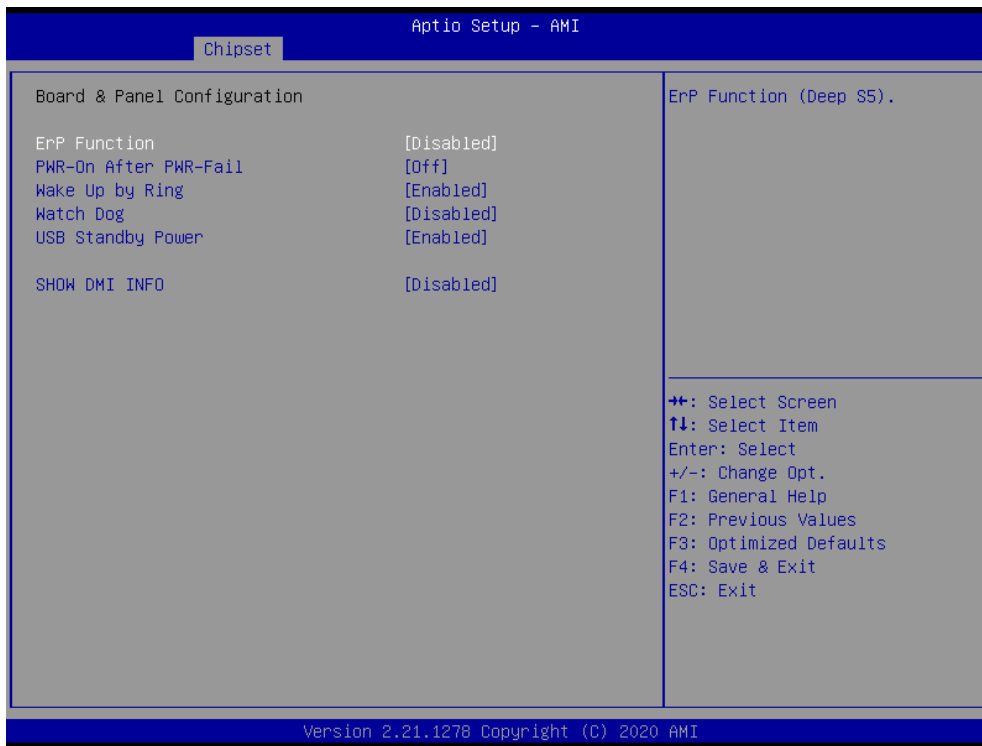

Item	Option	Description
ErP Function	Disabled[Default] Enabled	ErP Function (Deep S5).
PWR-On After PWR-Fail	Off[Default] On Last state	AC loss resume.
Wake Up by Ring	Disabled Enabled[Default]	Wake Up by Ring from S3/S4/S5.
Watch Dog	Disabled[Default] 30 sec 40 sec 50 sec 1 min 2 min 10 min 30 min	Select WatchDog.
USB Standby Power	Disabled Enabled[Default]	Enable/Disabled USB Standby Power during S3/S4/S5.
SHOW DMI INFO	Disabled[Default] Enabled	SHOW DMI INFO.

3.6.4 Security

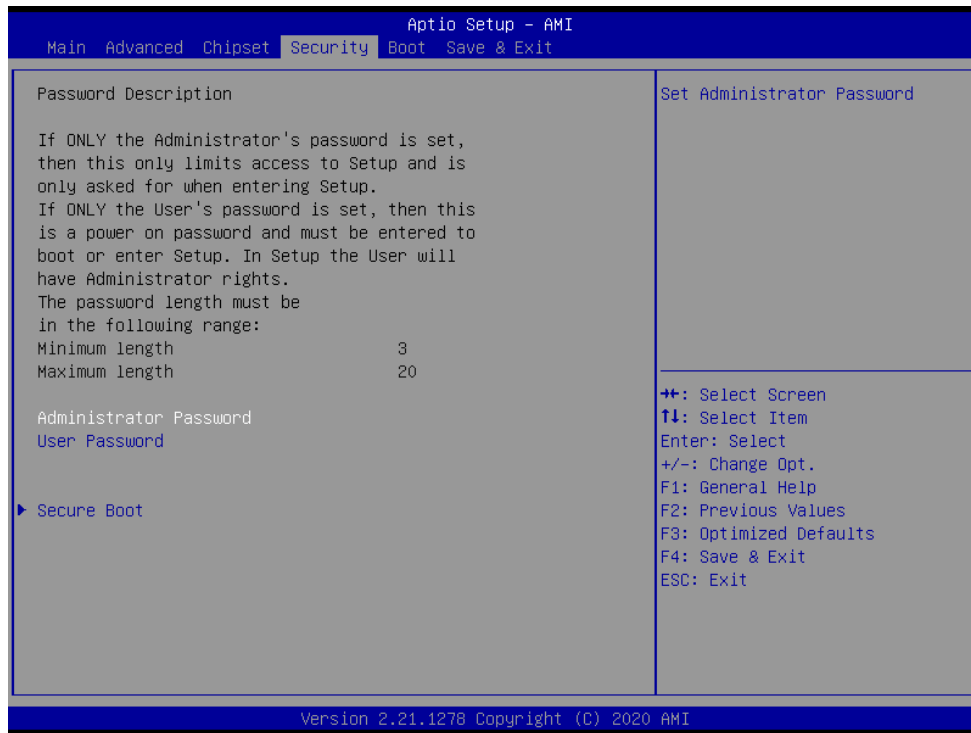

- **Administrator Password**
Set setup Administrator Password

- **User Password**
Set User Password

3.6.4.1 Secure Boot menu

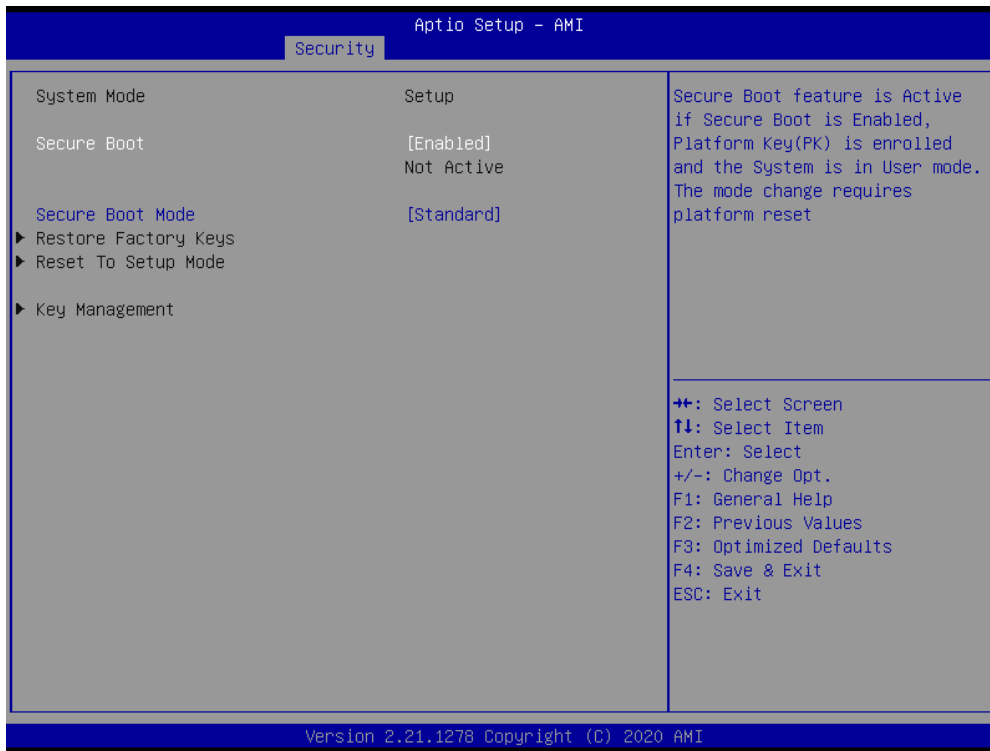

Item	Option	Description
Secure Boot	Disabled Enabled[Default]	Secure Boot can be enabled if 1.System running in User mode with enrolled Platform Key(PK) 2.CSM function is disabled.
Secure Boot Mode	Standard[Default] Custom	Customizable Secure Boot mode: In Custom mode Secure Boot Policy variables can be configured by a physically present user without full authentication.

3.6.5 Boot

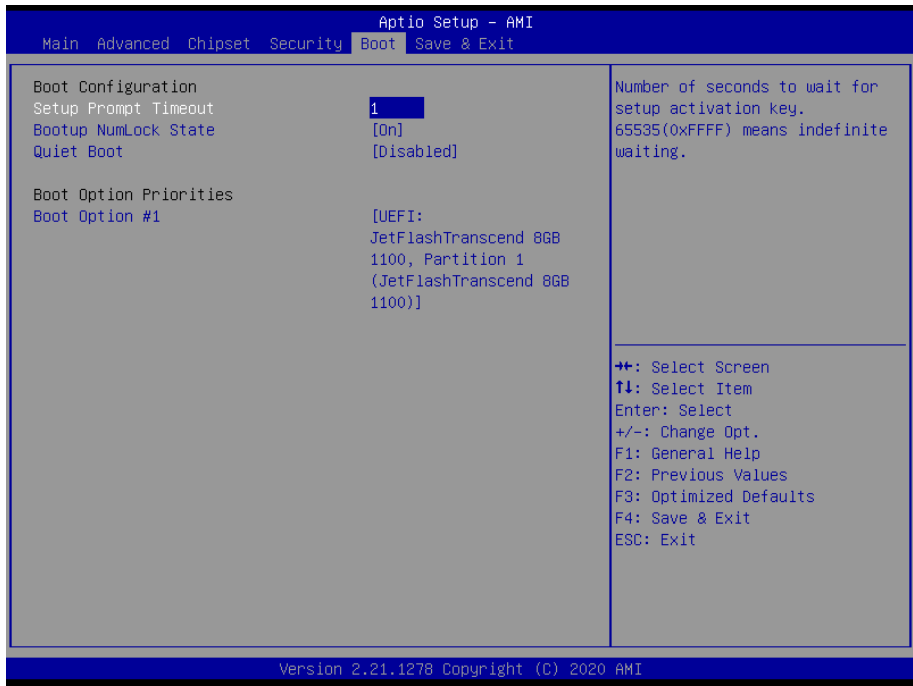

Item	Option	Description
Setup Prompt Timeout	1~ 65535	Number of seconds to wait for setup activation key. 65535(0xFFFF) means indefinite waiting.
Bootup NumLock State	On[Default] Off	Select the Keyboard NumLock state
Quiet Boot	Disabled[Default] Enabled	Enables or disables Quiet Boot option
Boot Option #1	Set the system boot order.	

3.6.6 Save and exit

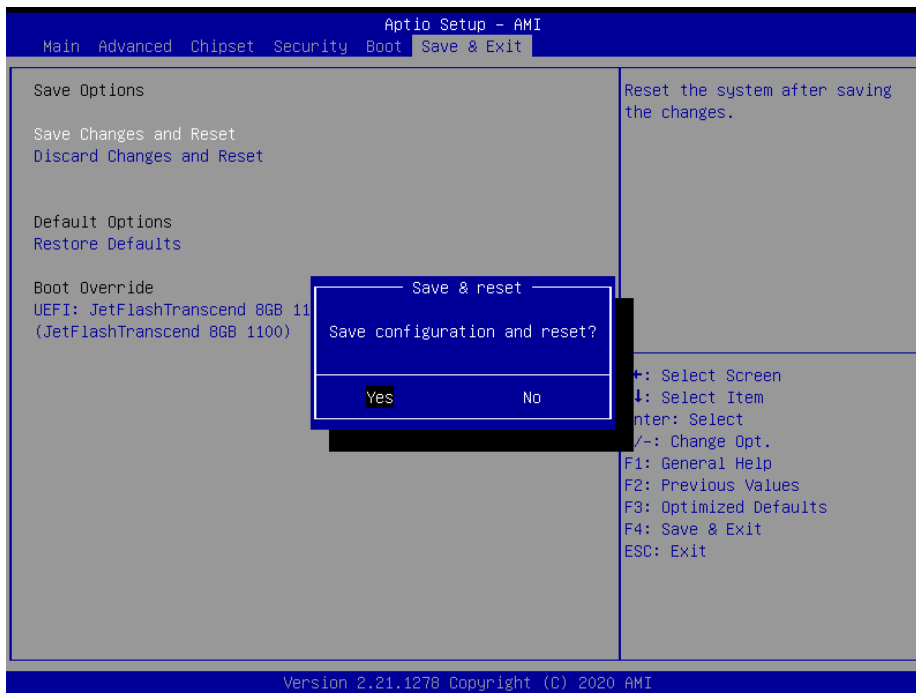
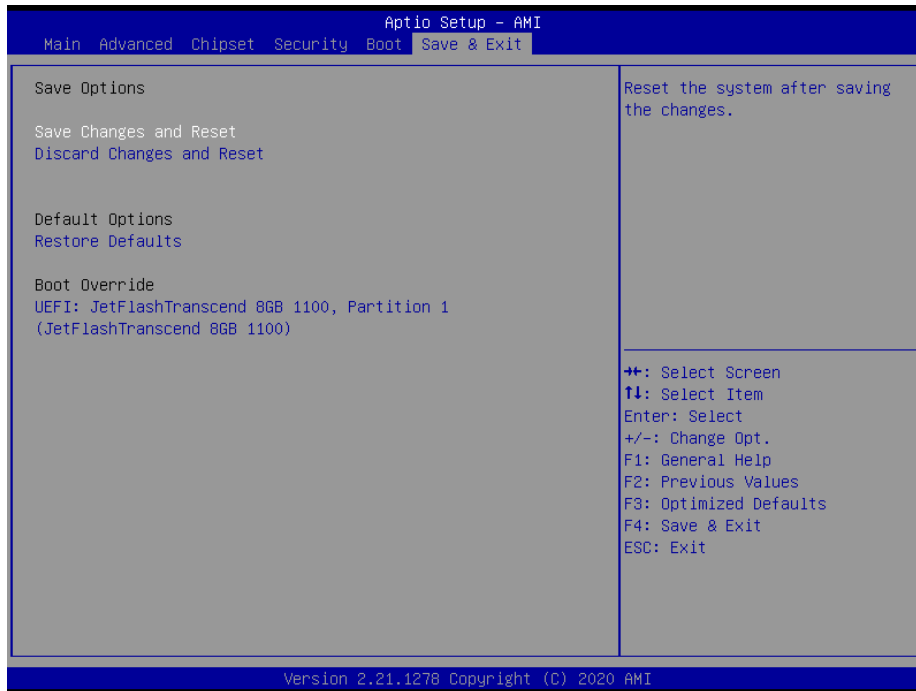

3.6.6.1 Save Changes and Reset

Reset the system after saving the changes.

3.6.6.2 Discard Changes and Reset

Any changes made to BIOS settings during this session of the BIOS setup program are discarded. The setup program then exits and reboots the controller.

3.6.6.3 *Restore Defaults*

This option restores all BIOS settings to the factory default. This option is useful if the controller exhibits unpredictable behavior due to an incorrect or inappropriate BIOS setting.

3.6.6.4 *Launch EFI Shell from filesystem device*

Attempts to Launch EFI Shell application (Shellx64.efi) from one of the available filesystem devices.

4. Drivers Installation



Note: Installation procedures and screen shots in this section are for your reference and may not be exactly the same as shown on your screen.

4.1 Install Chipset Driver

All drivers can be found on the Avalue Official Website:

<http://www.avalue.com.tw>.



Note: The installation procedures and screen shots in this section are based on Windows 10 operation system. If the warning message appears while the installation process, click Continue to go on.

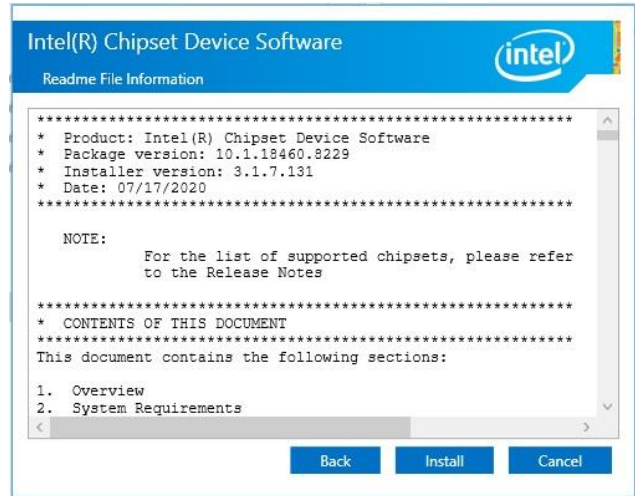

Step 3. Click Install.



Step1. Click Next.



Step 4. Click Finish to complete setup.



Step 2. Click Accept.

4.2 Install ME Driver

All drivers can be found on the Avalue Official Website:

<http://www.avalu.com.tw>.



Note: The installation procedures and screen shots in this section are based on Windows 10 operation system. If the warning message appears while the installation process, click Continue to go on.

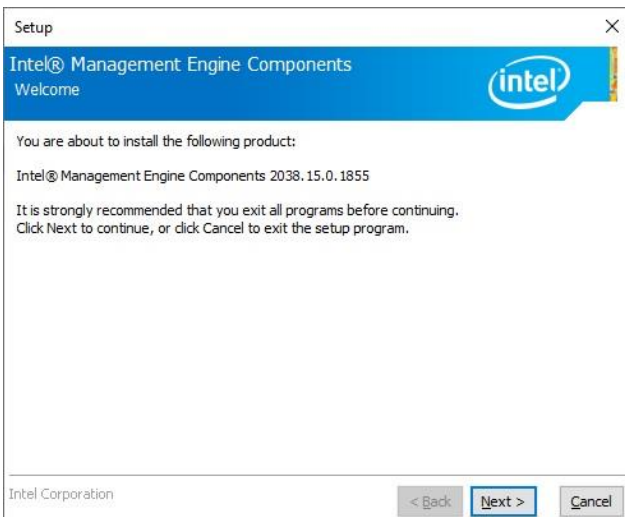

Step1. Click **Next** to start installation.



Step 2. Click **Next**.

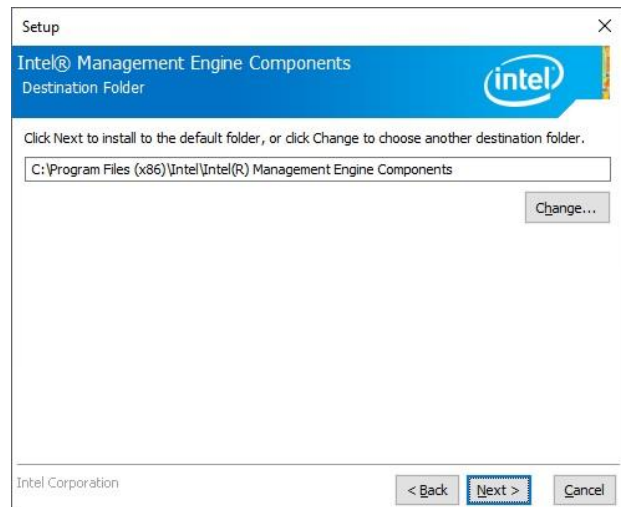

Step 3. Click **Next** to proceed setup.

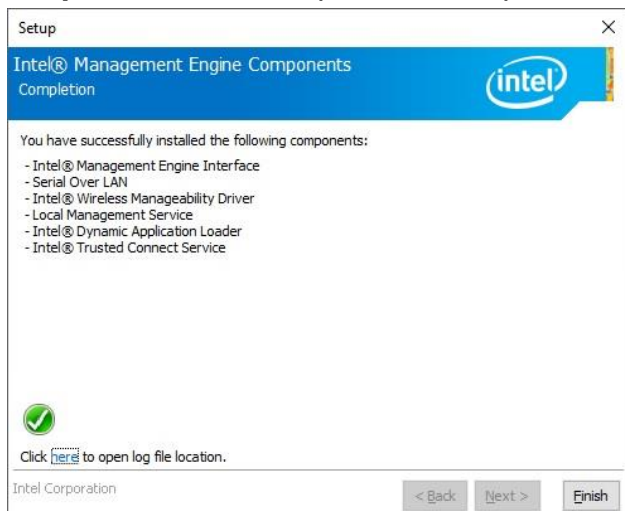

Step 4. Click **Finish** to complete setup.

4.3 Install VGA Driver

All drivers can be found on the Avalue Official Website:

<http://www.avalue.com.tw>.



Note: The installation procedures and screen shots in this section are based on Windows 10 operation system.

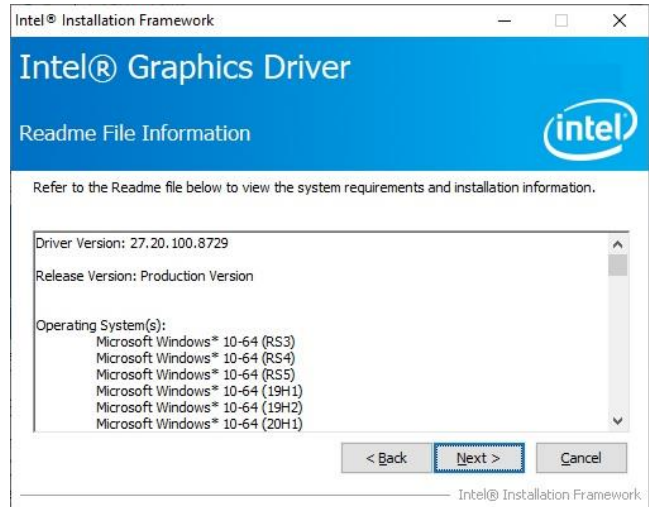

Step 3. Click Next.

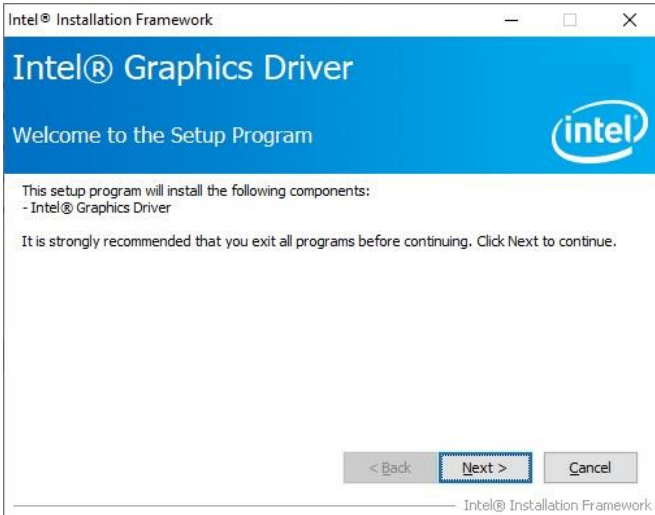

Step 1. Click Next to continue installation.

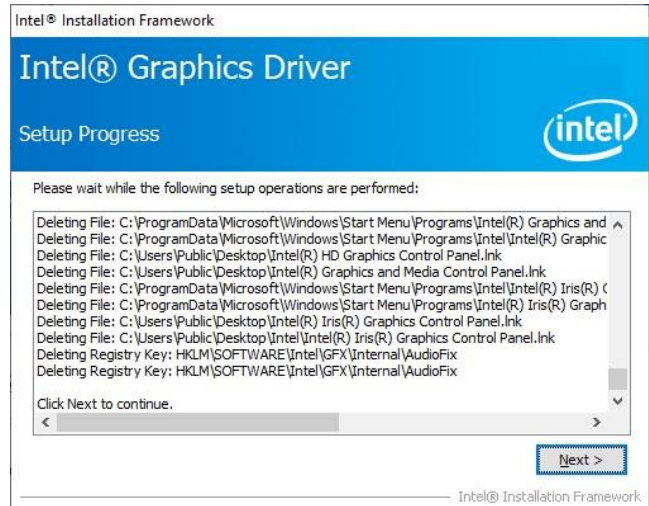

Step 4. Click Next.

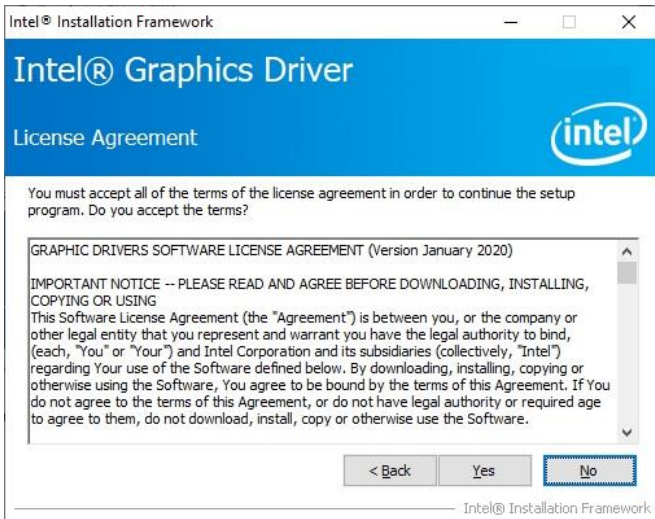

Step 2. Click Yes.

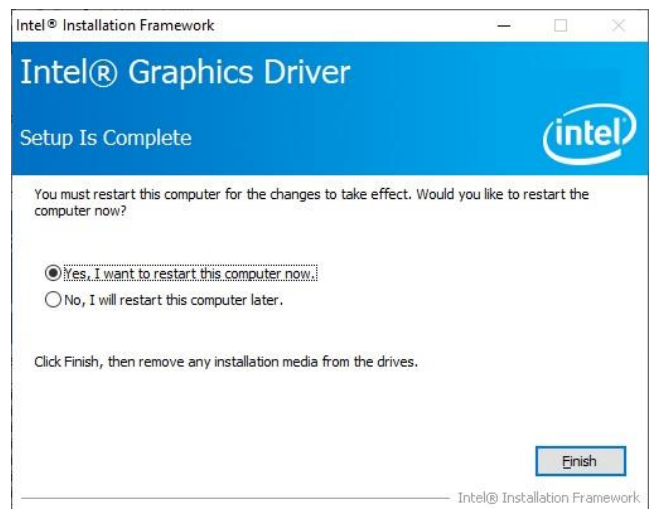

Step 5. Click Finish to complete setup.

4.4 Install Audio Driver (For Realtek ALC888S)

All drivers can be found on the Avalue Official Website:

<http://www.avalu.com.tw>.



Note: The installation procedures and screen shots in this section are based on Windows 10 operation system.

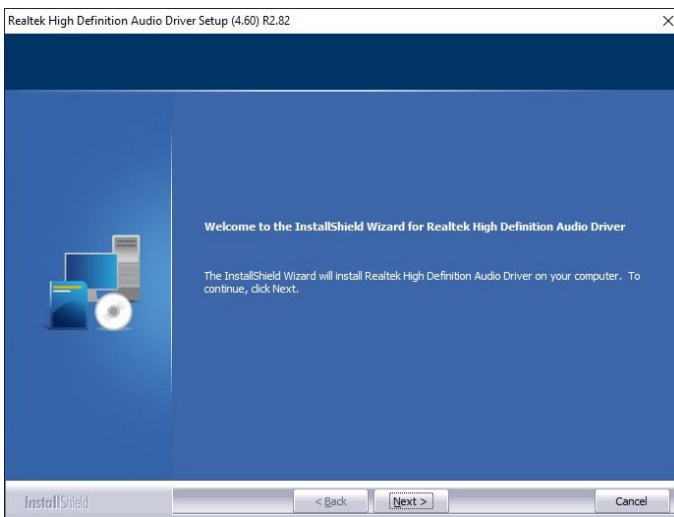

Step 1. Click **Next** to continue setup.

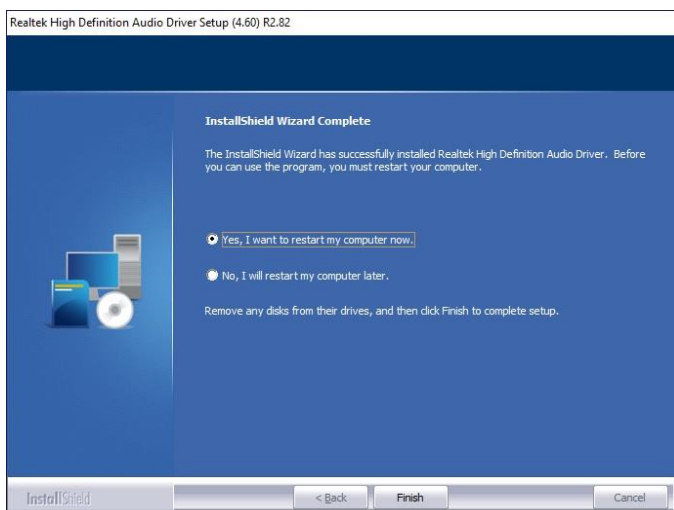

Step 2. Click **Finish** to complete the setup.

4.5 Install SerialIO Driver

All drivers can be found on the Avalue Official Website:
<http://www.avalue.com.tw>.



Note: The installation procedures and screen shots in this section are based on Windows 10 operation system.

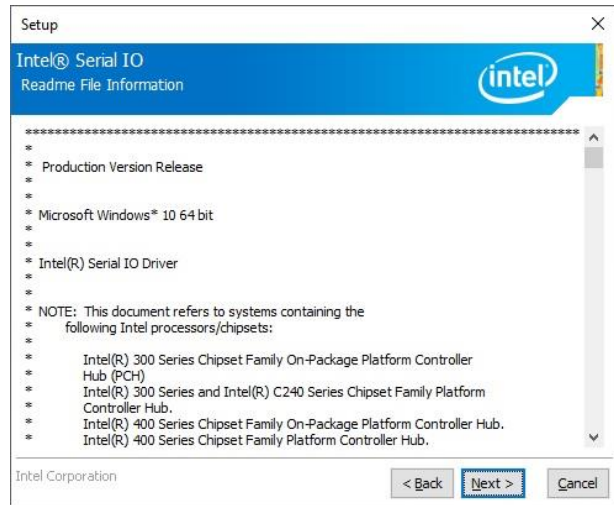

Step 3. Click Next.



Step 1. Click Next to continue installation.

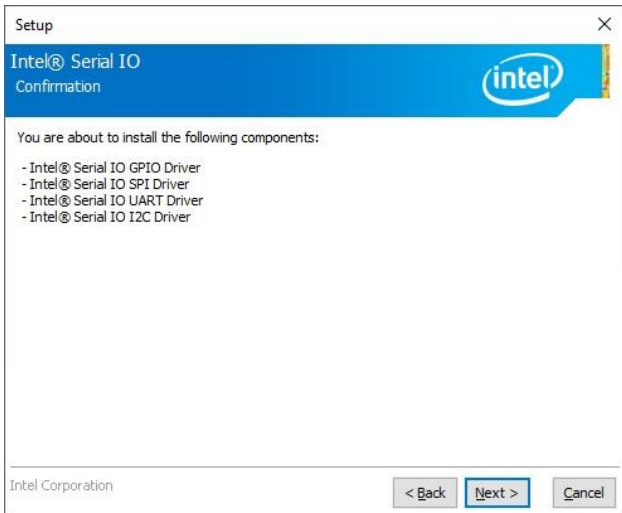

Step 4. Click Next.



Step 2. Click Next.



Step 5. Click Finish to complete setup.

4.6 Install Ethernet Driver

All drivers can be found on the Avalue Official Website:

<http://www.avalue.com.tw>.



Note: The installation procedures and screen shots in this section are based on Windows 10 operation system.

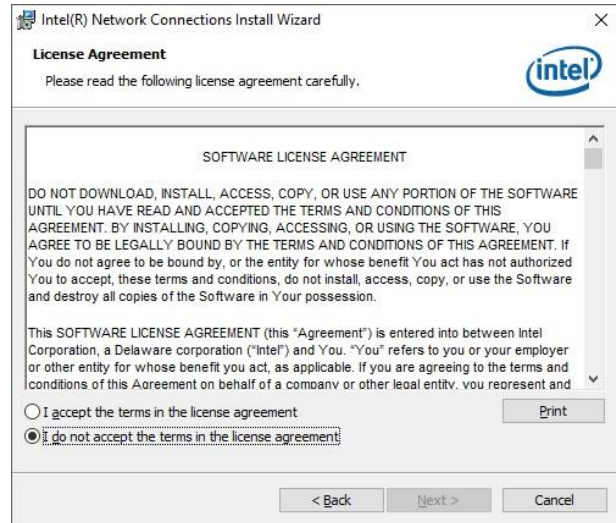

Step 3. Click Next.

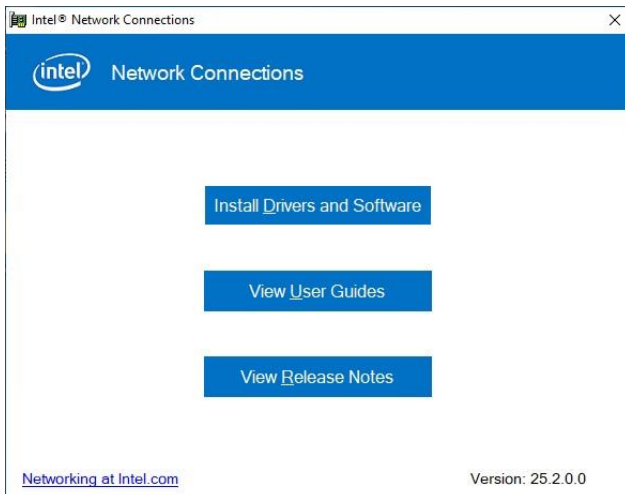

Step 1. Click Install Drivers and Software.

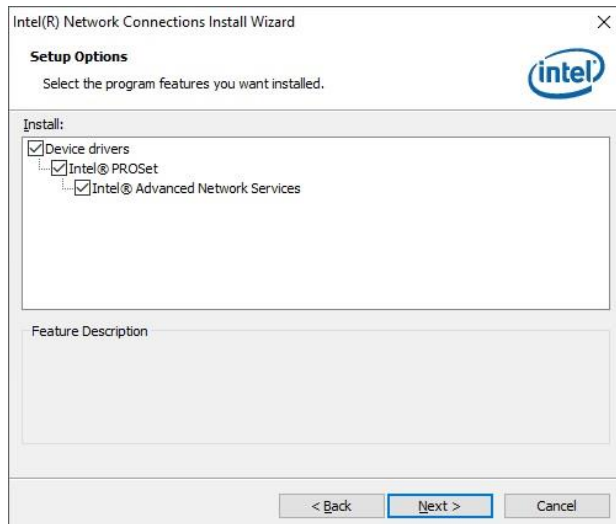

Step 4. Click Next.

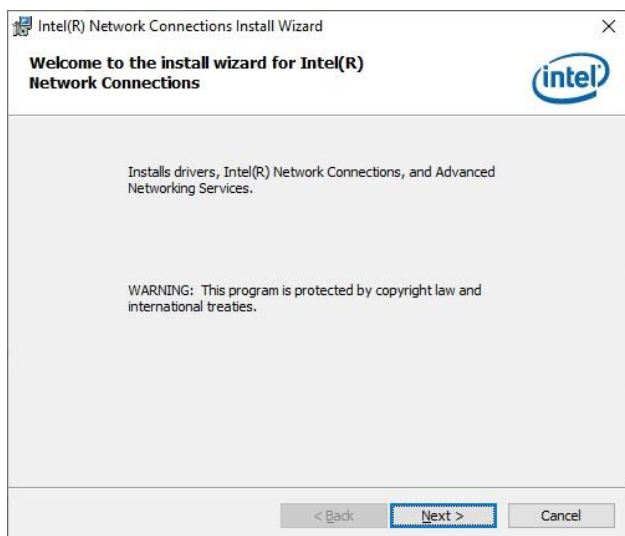

Step 2. Click Next.

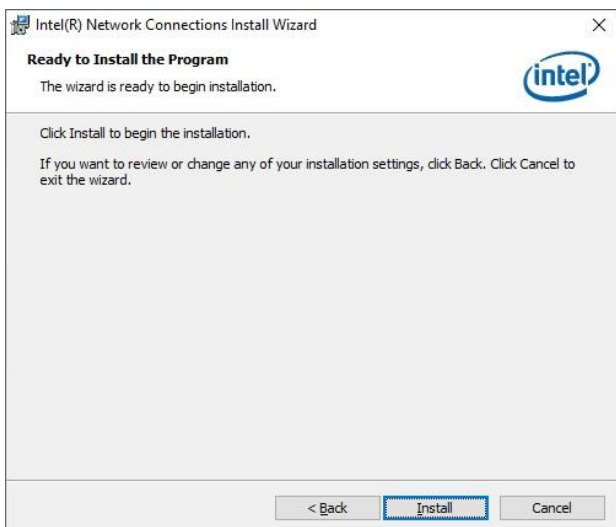

Step 5. Click Install.

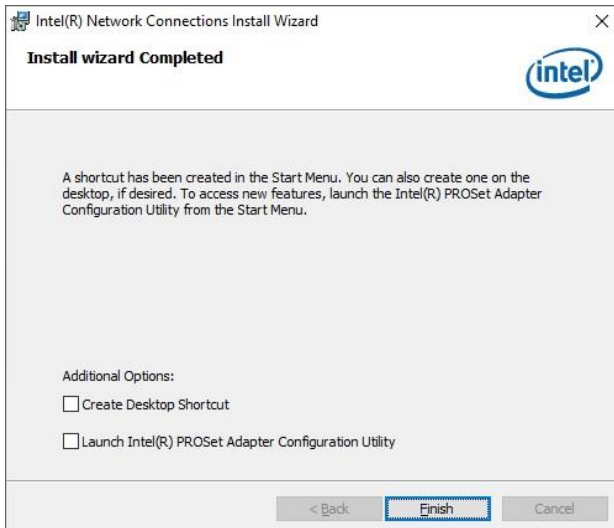

Step 6. Click **Finish** to complete the setup.

