

**MODEL:
WAFER-BW**

**3.5" SBC with 14nm Intel® Pentium® or Celeron® On-board SoC,
Dual HDMI, LVDS, Dual PCIe GbE, USB 3.0, PCIe Mini, mSATA,
SATA 6Gb/s, RS-232/422/485, HD Audio, SIM Slot and RoHS**

User Manual

Revision

Date	Version	Changes
September 28, 2018	1.03	Modified Section 4.7: Motherboard Installation
September 20, 2017	1.02	Modified Chapter 5: BIOS
November 28, 2016	1.01	Modified Section 2.3: Packing List
August 23, 2016	1.00	Initial release

Copyright

COPYRIGHT NOTICE

The information in this document is subject to change without prior notice in order to improve reliability, design and function and does not represent a commitment on the part of the manufacturer.

In no event will the manufacturer be liable for direct, indirect, special, incidental, or consequential damages arising out of the use or inability to use the product or documentation, even if advised of the possibility of such damages.

This document contains proprietary information protected by copyright. All rights are reserved. No part of this manual may be reproduced by any mechanical, electronic, or other means in any form without prior written permission of the manufacturer.

TRADEMARKS

All registered trademarks and product names mentioned herein are used for identification purposes only and may be trademarks and/or registered trademarks of their respective owners.

Manual Conventions



WARNING

Warnings appear where overlooked details may cause damage to the equipment or result in personal injury. Warnings should be taken seriously.



CAUTION

Cautionary messages should be heeded to help reduce the chance of losing data or damaging the product.



NOTE

These messages inform the reader of essential but non-critical information. These messages should be read carefully as any directions or instructions contained therein can help avoid making mistakes.



HOT SURFACE

This symbol indicates a hot surface that should not be touched without taking care.

Table of Contents

1 INTRODUCTION.....	1
1.1 INTRODUCTION.....	2
1.2 MODEL VARIATIONS	3
1.3 FEATURES.....	3
1.4 CONNECTORS	4
1.5 DIMENSIONS.....	5
1.6 DATA FLOW	7
1.7 TECHNICAL SPECIFICATIONS	8
2 UNPACKING	11
2.1 ANTI-STATIC PRECAUTIONS	12
2.2 UNPACKING PRECAUTIONS.....	12
2.3 PACKING LIST.....	13
2.4 OPTIONAL ITEMS	14
3 CONNECTORS	15
3.1 PERIPHERAL INTERFACE CONNECTORS.....	16
3.1.1 WAFER-BW Layout	16
3.1.2 Peripheral Interface Connectors	17
3.1.3 External Interface Panel Connectors.....	18
3.2 INTERNAL PERIPHERAL CONNECTORS	19
3.2.1 +12V DC-IN Power Connector	19
3.2.2 Audio Connector	20
3.2.3 Battery Connector.....	21
3.2.4 Digital I/O Connector.....	22
3.2.5 Fan Connector	23
3.2.6 I ² C Connector	24
3.2.7 Keyboard and Mouse Connector	25
3.2.8 LVDS Backlight Inverter Connector.....	26
3.2.9 LVDS LCD Connector	27
3.2.10 LAN LED Connectors	28

3.2.11 mSATA Module Slot.....	29
3.2.12 PCIe Mini Card Slot	30
3.2.13 Power and HDD LED Connector.....	32
3.2.14 Power Button Connector.....	33
3.2.15 Reset Button Connector	34
3.2.16 RS-232 Serial Port Connectors.....	35
3.2.17 RS-232/422/485 Serial Port Connectors	36
3.2.18 SATA 6Gb/s Connectors.....	37
3.2.19 SATA Power Connectors	38
3.2.20 SIM Card Slot.....	39
3.2.21 SMBus Connector	39
3.2.22 USB Connectors.....	40
3.3 EXTERNAL PERIPHERAL INTERFACE CONNECTOR PANEL	41
3.3.1 HDMI Connectors.....	41
3.3.2 LAN Connectors.....	42
3.3.3 Serial Port Connector (COM1)	43
3.3.4 USB Connectors.....	44
4 INSTALLATION	45
4.1 ANTI-STATIC PRECAUTIONS	46
4.2 INSTALLATION CONSIDERATIONS.....	46
4.3 SO-DIMM INSTALLATION	48
4.4 mSATA MODULE INSTALLATION	49
4.4.1 Full-size mSATA Module Installation	49
4.4.2 Half-size mSATA Module Installation.....	50
4.5 PCIe MINI CARD INSTALLATION	52
4.6 SYSTEM CONFIGURATION.....	53
4.6.1 AT/ATX Mode Select Switch.....	53
4.6.2 Clear CMOS Button.....	54
4.6.3 Flash Descriptor Security Override Switch.....	55
4.6.4 LVDS Voltage Select Jumper.....	56
4.7 MOTHERBOARD INSTALLATION	57
4.7.1 Heat Spreader	57
4.7.2 Motherboard Installation Example.....	58
4.8 INTERNAL PERIPHERAL DEVICE CONNECTIONS.....	59

WAFER-BW SBC

4.8.1 Audio Kit Installation.....	59
4.8.2 AT Power Connection	60
4.8.3 SATA Drive Connection	61
5 BIOS.....	63
5.1 INTRODUCTION.....	64
5.1.1 Starting Setup.....	64
5.1.2 Using Setup	64
5.1.3 Getting Help.....	65
5.1.4 Unable to Reboot after Configuration Changes	65
5.1.5 BIOS Menu Bar.....	65
5.2 MAIN.....	66
5.3 ADVANCED.....	67
5.3.1 ACPI Settings.....	68
5.3.2 RTC Wake Settings.....	69
5.3.3 Serial Port Console Redirection	70
5.3.3.1 Legacy Console Redirection Settings	71
5.3.3.2 Console Redirection Settings	72
5.3.4 F81866 Super IO Configuration	74
5.3.4.1 Serial Port n Configuration	75
5.3.4.1.1 Serial Port 1 Configuration	75
5.3.4.1.2 Serial Port 2 Configuration	76
5.3.4.1.3 Serial Port 3 Configuration	77
5.3.4.1.4 Serial Port 4 Configuration	78
5.3.4.1.5 Serial Port 5 Configuration	79
5.3.4.1.6 Serial Port 6 Configuration	80
5.3.5 iWDD H/W Monitor.....	81
5.3.5.1 Smart Fan Mode Configuration	82
5.3.6 IEI Feature.....	85
5.3.7 CPU Configuration.....	86
5.3.8 SATA Configuration	87
5.3.9 NVMe Configuration.....	89
5.3.10 USB Configuration.....	90
5.4 CHIPSET	91
5.4.1 North Bridge Configuration.....	92

5.4.1.1 Intel IGD Configuration.....	93
5.4.2 South Bridge Configuration.....	96
5.4.2.1 PCI Express Configuration.....	97
5.5 SECURITY.....	98
5.6 BOOT.....	99
5.7 EXIT.....	101
6 SOFTWARE DRIVERS	103
6.1 AVAILABLE DRIVERS	104
6.2 DRIVER DOWNLOAD	104
A REGULATORY COMPLIANCE	107
B PRODUCT DISPOSAL	109
C BIOS MENU OPTIONS.....	111
D DIGITAL I/O INTERFACE.....	114
E WATCHDOG TIMER.....	117
F HAZARDOUS MATERIALS DISCLOSURE.....	120

List of Figures

Figure 1-1: WAFER-BW	2
Figure 1-2: Connectors	4
Figure 1-3: Dimensions with Heat Spreader (mm)	6
Figure 1-4: Data Flow Diagram	7
Figure 3-1: Connector and Jumper Locations (Front)	16
Figure 3-2: +12V DC-IN Power Connector Location	19
Figure 3-3: Audio Connector Location	20
Figure 3-4: Battery Connector Location	21
Figure 3-5: Digital I/O Connector Location	22
Figure 3-6: Fan Connector Location	23
Figure 3-7: I ² C Connector Location	24
Figure 3-8: Keyboard and Mouse Connector Location	25
Figure 3-9: Backlight Inverter Connector Location	26
Figure 3-10: LVDS Connector Location	27
Figure 3-11: LAN LED Connector Locations	28
Figure 3-12: mSATA Module Slot Location	29
Figure 3-13: PCIe Mini Card Slot Location	31
Figure 3-14: Power and HDD LED Connector Location	32
Figure 3-15: Power Button Connector Location	33
Figure 3-16: Reset Button Connector Location	34
Figure 3-17: RS-232 Serial Port Connector Locations	35
Figure 3-18: RS-232/422/485 Connector Locations	36
Figure 3-19: SATA 6Gb/s Connector Locations	37
Figure 3-20: SATA Power Connector Locations	38
Figure 3-21: SIM Card Slot Location	39
Figure 3-22: SMBus Connector Location	39
Figure 3-23: USB Connector Locations	40
Figure 3-24: External Peripheral Interface Connector	41
Figure 3-25: HDMI Connector Pinout Locations	42
Figure 3-26: LAN Connector	43
Figure 3-27: Serial Port Pinout Locations	43

Figure 3-28: USB 3.0 Port Pinout Locations	44
Figure 4-1: SO-DIMM Installation	48
Figure 4-2: Removing the Retention Screw	49
Figure 4-3: Inserting the Full-size mSATA Module into the Slot at an Angle	50
Figure 4-4: Securing the mSATA Module.....	50
Figure 4-5: Removing the Retention Screw and the Standoff	51
Figure 4-6: Installing the Standoff	51
Figure 4-7: Inserting the Half-size mSATA Module into the Slot at an Angle.....	52
Figure 4-8: Securing the Half-size mSATA Module.....	52
Figure 4-9: AT/ATX Mode Select Switch Location	53
Figure 4-10: Clear CMOS Button Location.....	54
Figure 4-11: Flash Descriptor Security Override Switch Location.....	55
Figure 4-12: LVDS Voltage Select Jumper Location.....	56
Figure 4-13: Heat Spreader Retention Screws	58
Figure 4-14: Motherboard Installation Example	58
Figure 4-15: Audio Kit Cable Connection	59
Figure 4-16: Power Cable to Motherboard Connection	60
Figure 4-17: Connect Power Cable to Power Supply.....	61
Figure 4-18: SATA Drive Cable Connection.....	62
Figure 6-1: IEI Resource Download Center.....	104

List of Tables

Table 1-1: WAFER-BW Model Variations.....	3
Table 1-2: Technical Specifications.....	10
Table 3-1: Peripheral Interface Connectors	18
Table 3-2: Rear Panel Connectors	18
Table 3-3: +12V DC-IN Power Connector Pinouts	19
Table 3-4: Audio Connector Pinouts	20
Table 3-5: Battery Connector Pinouts	21
Table 3-6: Digital I/O Connector Pinouts.....	22
Table 3-7: Fan Connector Pinouts	23
Table 3-8: I ² C Connector Pinouts.....	24
Table 3-9: Keyboard and Mouse Connector Pinouts.....	25
Table 3-10: Backlight Inverter Connector Pinouts	26
Table 3-11: LVDS Connector Pinouts.....	28
Table 3-12: LAN LED Connector Pinouts.....	28
Table 3-13: mSATA Module Slot Pinouts	30
Table 3-14: PCIe Mini Card Slot Pinouts	32
Table 3-15: Power and HDD LED Connector Pinouts.....	32
Table 3-16: Power Button Connector Pinouts	33
Table 3-17: Reset Button Connector Pinouts	34
Table 3-18: RS-232 Serial Port Connector Pinouts	35
Table 3-19: RS-232/422/485 Connector Pinouts	36
Table 3-20: DB-9 RS-422/485 Pinouts.....	37
Table 3-21: SATA Power Connector Pinouts.....	38
Table 3-22: SMBus Connector Pinouts	40
Table 3-23: USB Connector Pinouts.....	40
Table 3-24: HDMI Connector Pinouts	42
Table 3-25: LAN Pinouts	42
Table 3-26: Serial Port Pinouts.....	43
Table 3-27: USB 3.0 Port Pinouts.....	44
Table 4-1: AT/ATX Mode Select Switch Settings.....	53
Table 4-2: Flash Descriptor Security Override Switch Settings	55

Table 4-3: LVDS Voltage Select Jumper Settings	56
Table 5-1: BIOS Navigation Keys	65

List of BIOS Menus

BIOS Menu 1: Main	66
BIOS Menu 2: Advanced	67
BIOS Menu 3: ACPI Settings	68
BIOS Menu 4: RTC Wake Settings	69
BIOS Menu 5: Serial Port Console Redirection	70
BIOS Menu 6: Legacy Console Redirection Settings	71
BIOS Menu 7: Console Redirection Settings	72
BIOS Menu 8: F81866 Super IO Configuration	74
BIOS Menu 9: Serial Port n Configuration	75
BIOS Menu 10: iWDD H/W Monitor	81
BIOS Menu 11: Smart Fan Mode Configuration	82
BIOS Menu 12: IEI Feature	85
BIOS Menu 13: CPU Configuration	86
BIOS Menu 14: SATA Configuration	87
BIOS Menu 15: NVMe Configuration	89
BIOS Menu 16: USB Configuration	90
BIOS Menu 17: Chipset	91
BIOS Menu 18: North Bridge Configuration	92
BIOS Menu 19: Intel IGD Configuration	93
BIOS Menu 20: South Bridge Configuration	96
BIOS Menu 21: PCI Express Configuration	97
BIOS Menu 22: Security	98
BIOS Menu 23: Boot	99
BIOS Menu 24: Exit	101

Chapter

1

Introduction

1.1 Introduction

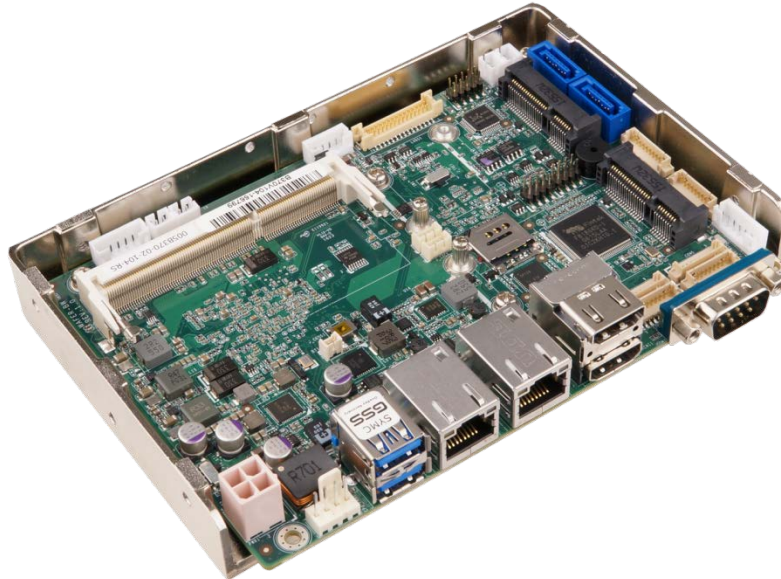

Figure 1-1: WAFER-BW

The WAFER-BW series is a 3.5" single board computer. It has an on-board 14nm Intel® Pentium® or Celeron® processor, and supports one 204-pin 1600/1333 MHz single-channel unbuffered DDR3 Low Voltage (DDR3L) SDRAM SO-DIMM slot with up to 8.0 GB of memory.

The WAFER-BW series includes two HDMI connectors and an 18-/24-bit LVDS connector for triple independent display. Two RJ-45 GbE connectors provide the system with smooth connections to an external LAN.

Expansion and I/O include one PCIe Mini slot supporting mSATA modules, one PCIe Mini slot with SIM card holder, two USB 3.0 connectors on the rear panel, four USB 2.0 connectors by pin header and two SATA 6Gb/s connectors. Serial device connectivity is provided by four internal RS-232 connectors and two internal RS-232/422/485 connectors.

WAFER-BW SBC

1.2 Model Variations

The model variations of the WAFER-BW series are listed below.

Model No.	SoC
WAFER-BW-N4-R10	Intel® Pentium® N3710 on-board SoC (2.56 GHz, quad-core, 2 MB cache, TDP=6 W)
WAFER-BW-N3-R10	Intel® Celeron® N3160 on-board SoC (2.24 GHz, quad-core, 2 MB cache, TDP=6 W)
WAFER-BW-N2-R10	Intel® Celeron® N3060 on-board SoC (2.48 GHz, dual-core, 2 MB cache, TDP=6 W)
WAFER-BW-N1-R10*	Intel® Celeron® N3010 on-board SoC (2.24 GHz, dual-core, 2 MB cache, TDP=4 W)
*By order production, MOQ 100	

Table 1-1: WAFER-BW Model Variations

1.3 Features

Some of the WAFER-BW motherboard features are listed below:

- 3.5" motherboard supports 14nm Intel® Pentium®/Celeron® on-board SoC
- Triple independent display support
- One 1600/1333 MHz DDR3L SO-DIMM slot supports up to 8 GB of memory
- Two SATA 6Gb/s connectors with 5 V power output
- Two USB 3.0 external connectors
- Four RS-232 connectors and two RS-232/422/485 connectors
- One SIM card holder on board
- Two full-size/half-size PCIe Mini card slots for expansion
- Support mSATA modules
- Optional eMMC 4.51
- IEI One Key Recovery solution allows you to create rapid OS backup and recovery

1.4 Connectors

The connectors on the WAFER-BW are shown in the figure below.

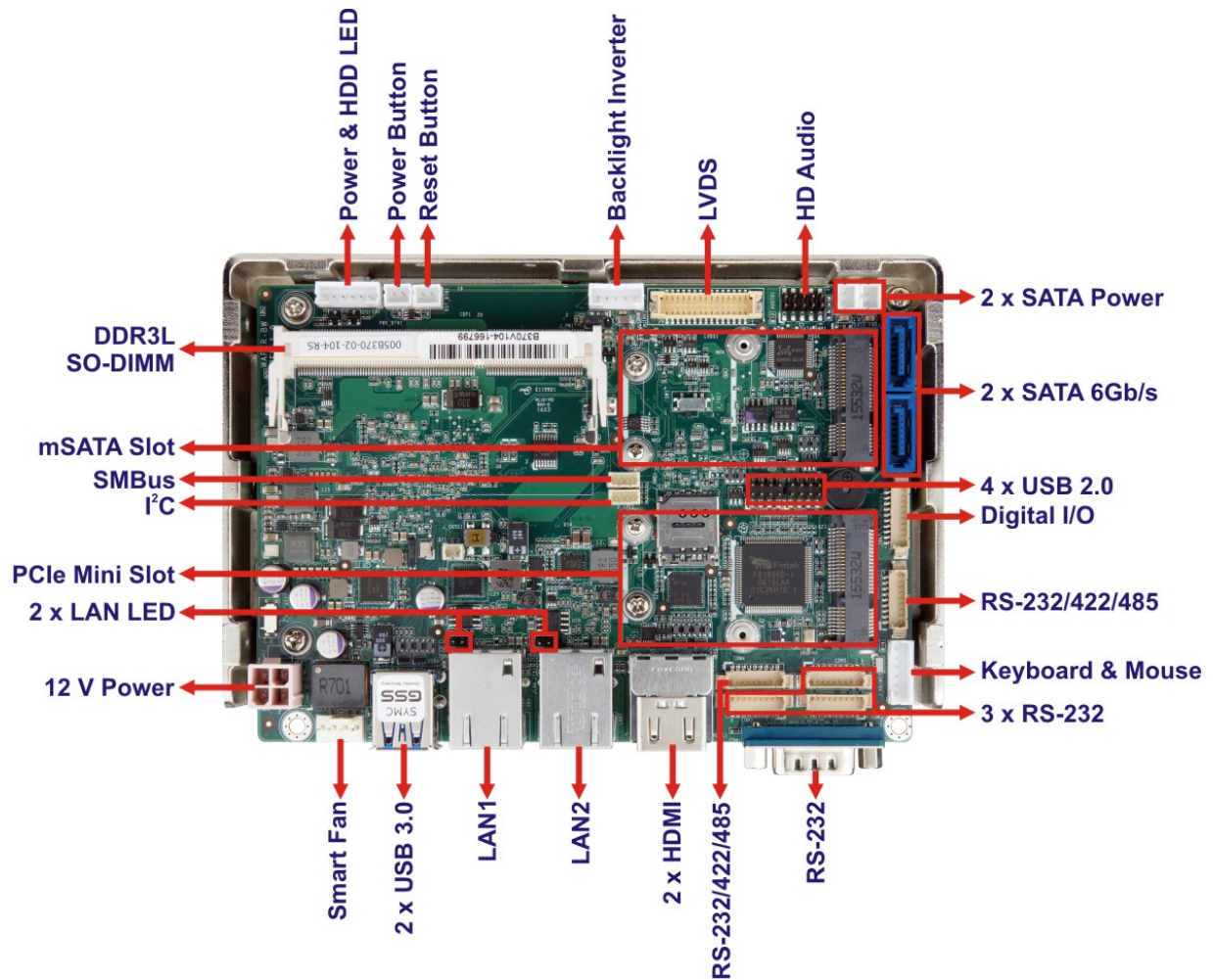

Figure 1-2: Connectors



WARNING:

The heat spreader installed on the WAFER-BW can only serve as a heat conductor, which needs additional heat dissipation mechanism to achieve suitable thermal condition. DO NOT put the WAFER-BW with the heat spreader directly on a surface that cannot dissipate system heat.

WAFER-BW SBC

1.5 Dimensions

The dimensions of the board are listed below:

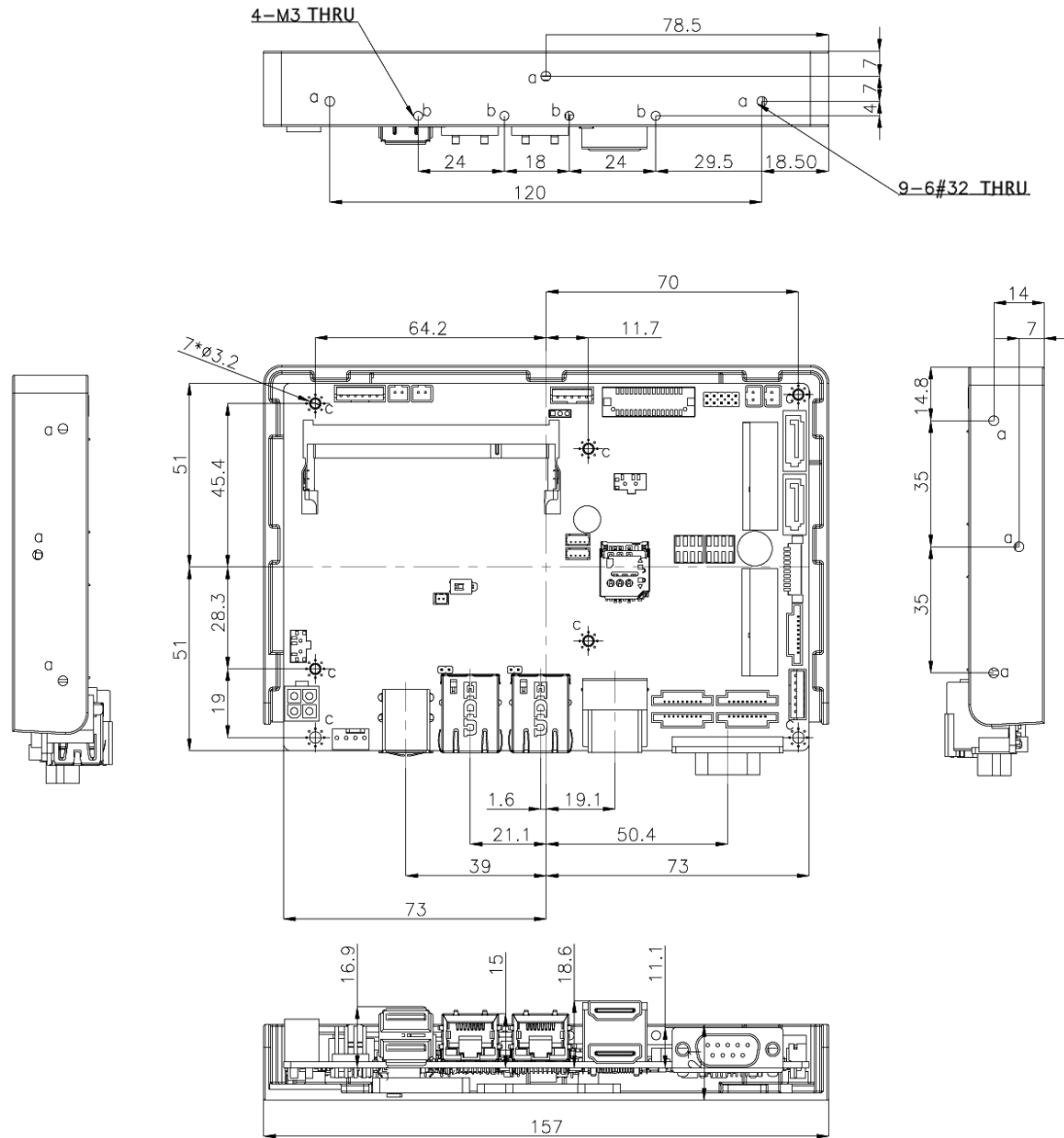

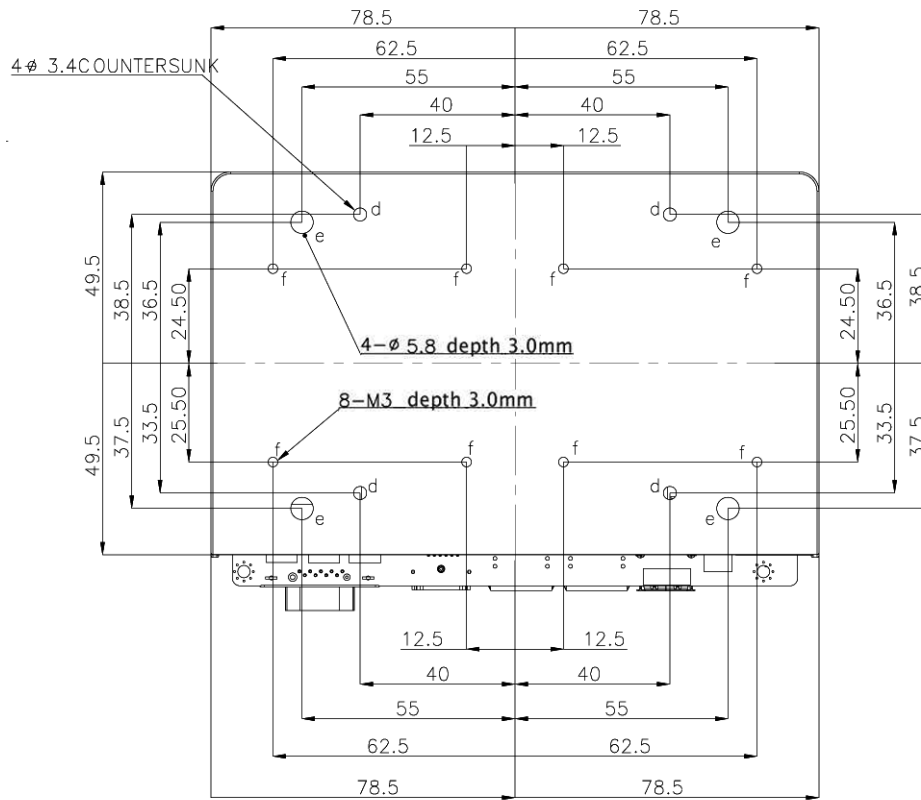

Figure 1-3: Dimensions with Heat Spreader (mm)

WAFER-BW SBC

1.6 Data Flow

Figure 1-4 shows the data flow between the system chipset, the CPU and other components installed on the motherboard.

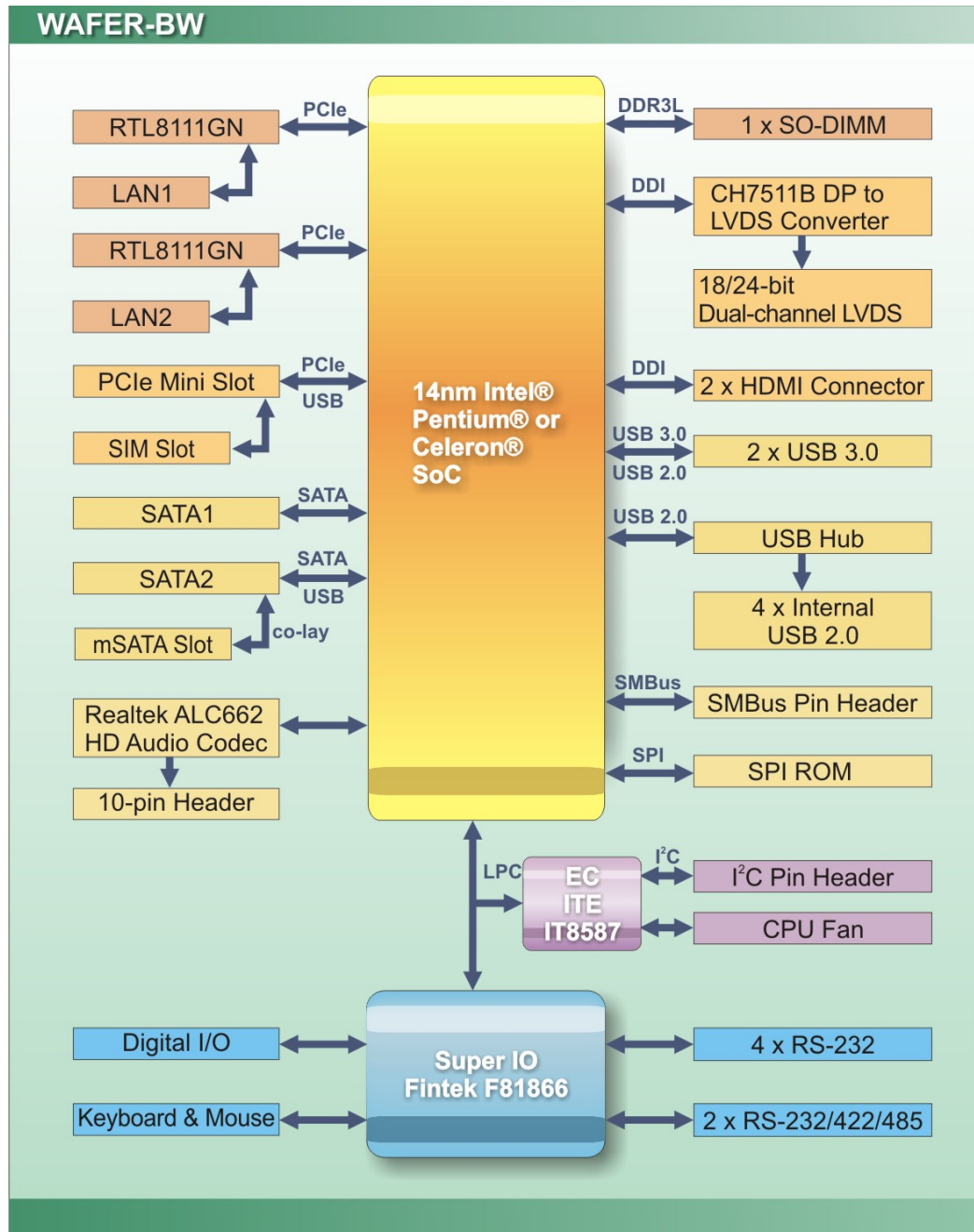

Figure 1-4: Data Flow Diagram

1.7 Technical Specifications

WAFER-BW technical specifications are listed below.

Specification	WAFER-BW
SoC	Intel® Pentium® N3710 on-board SoC (2.56 GHz, quad-core, 2 MB cache, TDP=6 W) Intel® Celeron® N3160 on-board SoC (2.24 GHz, quad-core, 2 MB cache, TDP=6 W) Intel® Celeron® N3060 on-board SoC (2.48 GHz, dual-core, 2 MB cache, TDP=6 W) Intel® Celeron® N3010 on-board SoC (2.24 GHz, dual-core, 2 MB cache, TDP=4 W)
BIOS	AMI UEFI BIOS
Memory	One 204-pin 1600/1333* MHz single-channel DDR3L SDRAM unbuffered SO-DIMM slot (system max. 8 GB) <i>* DDR3L 1333 MHz operation will be downgraded to 1066 MHz due to Intel® SoC limitation.</i>
Graphics	8 th generation Intel® HD Graphics with 16 low-power execution units, supporting DX11.1, OpenGL 4.2 and OpenCL1.2
Display Output	Triple independent display 2 x HDMI (up to 3840x2160 @ 30 Hz) 1 x 18/24-bit dual-channel LVDS by CH7511B DP to LVDS converter (up to 1920x1200 @ 60 Hz)
Ethernet	Dual Realtek RTL8111GN PCIe GbE controller
Digital I/O	8-bit digital I/O by 10-pin (1x10) wafer
Super IO	Fintek F81866D-I
Embedded Controller	ITE IT8587VG-FX
Audio	Realtek ALC662 HD codec
Watchdog Timer	Software programmable support 1~255 sec. system reset

WAFER-BW SBC

Specification	WAFER-BW
I/O Interface	
Audio Connector	1 x Analog audio by 10-pin (2x5) header
Ethernet	2 x RJ-45 GbE port
Keyboard/Mouse	1 x KB/MS by 6-pin (1x6) wafer
Serial Ports	1 x RS-232 on rear I/O 3 x RS-232 by 9-pin (1x9) wafer 2 x RS-232/422/485 by 9-pin (1x9) wafer
USB Ports	2 x USB 3.0 on rear I/O 4 x USB 2.0 by 8-pin (2x4) header
Front Panel	1 x Power LED & HDD LED by 6-pin (1x6) wafer 1 x Power button by 2-pin wafer 1 x Reset button by 2-pin wafer
LAN LED	2 x LAN link LED connector by 2-pin header
Fan	1 x Smart fan connector by 4-pin (1x4) wafer
SMBus	1 x SMBus connector by 4-pin (1x4) wafer
I²C	1 x I ² C connector by 4-pin (1x4) wafer
Storage	2 x SATA 6Gb/s with 5 V SATA power connectors 1 x eMMC 4.51 (optional)
Expansion	Two Full-size/Half-size PCIe Mini card slots: <ul style="list-style-type: none"> ▪ One supports mSATA module (colay SATA2) ▪ One with a SIM card holder
Environmental and Power Specifications	
Power Supply	12 V DC input only (AT/ATX support)
Power Connector	1 x Internal power connector by 4-pin (2x2) connector
Power Consumption	+12 V @ 1.52 A (Intel® Pentium® processor N3710 with 8 GB 1600 MHz DDR3L memory)
Operating Temperature	-20°C ~ 60°C
Storage Temperature	-30°C ~ 70°C

Specification	WAFER-BW
Humidity	5% ~ 95%, non-condensing
Physical Specifications	
Dimensions	146 mm x 102 mm
Weight GW/NW	600 g / 250 g

Table 1-2: Technical Specifications

Chapter

2

Unpacking

2.1 Anti-static Precautions



WARNING!

Static electricity can destroy certain electronics. Make sure to follow the ESD precautions to prevent damage to the product, and injury to the user.

Make sure to adhere to the following guidelines:

- **Wear an anti-static wristband:** Wearing an anti-static wristband can prevent electrostatic discharge.
- **Self-grounding:** Touch a grounded conductor every few minutes to discharge any excess static buildup.
- **Use an anti-static pad:** When configuring any circuit board, place it on an anti-static mat.
- **Only handle the edges of the PCB:** Don't touch the surface of the motherboard. Hold the motherboard by the edges when handling.

2.2 Unpacking Precautions

When the WAFER-BW is unpacked, please do the following:

- Follow the antistatic guidelines above.
- Make sure the packing box is facing upwards when opening.
- Make sure all the packing list items are present.

WAFER-BW SBC





2.3 Packing List



NOTE:

If any of the components listed in the checklist below are missing, do not proceed with the installation. Contact the IEI reseller or vendor the WAFER-BW was purchased from or contact an IEI sales representative directly by sending an email to sales@ieiworld.com.



The WAFER-BW is shipped with the following components:

Quantity	Item and Part Number	Image
1	WAFER-BW single board computer with heat spreader	
1	Audio cable	
1	Power cable	
1	RS-232/422/485 cable	
2	SATA and power cable	

1	Quick Installation Guide	
---	--------------------------	---

2.4 Optional Items

The following are optional components which may be separately purchased:

Item and Part Number	Image
KB/MS PS/2 Y-cable, 135 mm, p=2.0 mm (P/N: 32000-023800-RS)	
Dual USB port cable, 210mm, p=2.0 mm (P/N: 32001-008600-200-RS)	

Chapter

3

Connectors

3.1 Peripheral Interface Connectors

This chapter details all the jumpers and connectors.

3.1.1 WAFER-BW Layout

The figures below show all the connectors and jumpers.

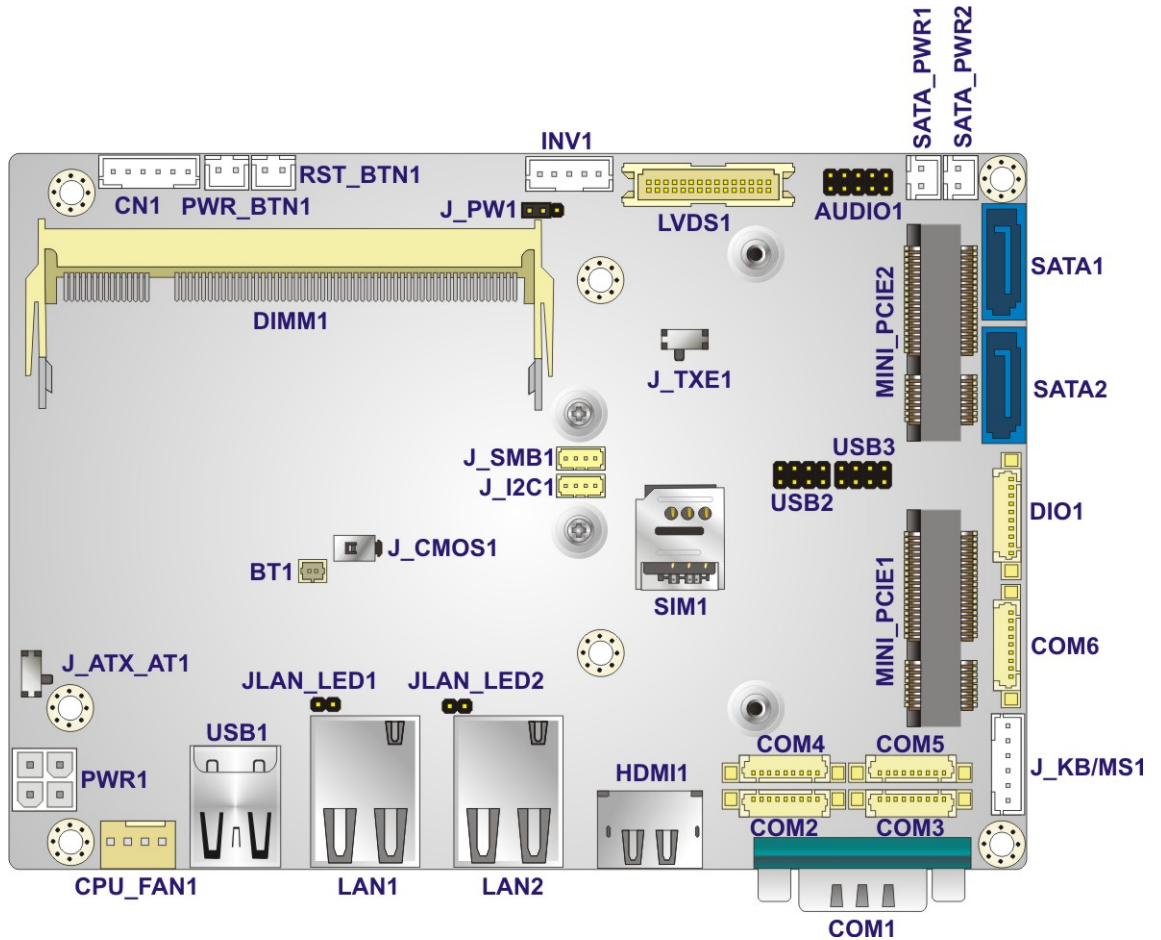

Figure 3-1: Connector and Jumper Locations (Front)

WAFER-BW SBC

3.1.2 Peripheral Interface Connectors

The table below lists all the connectors on the board.

Connector	Type	Label
+12V DC-IN power connector	4-pin Molex	PWR1
Audio connector	10-pin header	AUDIO1
Battery connector	2-pin wafer	BT1
Digital I/O connector	10-pin wafer	DIO1
Fan connector, CPU	4-pin wafer	CPU_FAN1
I ² C connector	4-pin wafer	J_I2C1
Keyboard & mouse connector	6-pin wafer	J_KB/MS1
LVDS backlight inverter connector	5-pin wafer	INV1
LVDS LCD connector	30-pin crimp	LVDS1
LAN LED connectors	2-pin header	JLAN_LED1, JLAN_LED2
Memory slot	204-pin DDR3L SO-DIMM	DIMM1
mSATA module slot	PCIe Mini slot	MINI_PCIE2
PCIe Mini card slot	PCIe Mini slot	MINI_PCIE1
Power and HDD LED connector	6-pin wafer	CN1
Power button connector	2-pin wafer	PWR_BTN1
Reset button connector	2-pin wafer	RST_BTN1
RS-232 serial port connectors	9-pin wafer	COM2, COM3, COM5
RS-232/422/485 serial port connectors	9-pin wafer	COM4, COM6

SATA 6Gb/s connectors	7-pin SATA connector	SATA1, SATA2
SATA power connectors	2-pin wafer	SATA_PWR1, SATA_PWR2
SIM card slot	Micro SIM card slot	SIM1
SMBus connector	4-pin wafer	J_SMB1
USB 2.0 connector	8-pin header	USB2, USB3

Table 3-1: Peripheral Interface Connectors

3.1.3 External Interface Panel Connectors

The table below lists the connectors on the external I/O panel.

Connector	Type	Label
LAN connectors	RJ-45	LAN1, LAN2
HDMI connectors	HDMI	HDMI1
Serial port connector, RS-232	DB-9	COM1
USB 3.0 connectors	USB 3.0	USB1

Table 3-2: Rear Panel Connectors

WAFER-BW SBC

3.2 Internal Peripheral Connectors

The section describes all of the connectors on the WAFER-BW.

3.2.1 +12V DC-IN Power Connector

- CN Label:** PWR1
- CN Type:** 4-pin Molex, p=4.2 mm
- CN Location:** See **Figure 3-2**
- CN Pinouts:** See **Table 3-3**

The connector supports the +12V power supply.

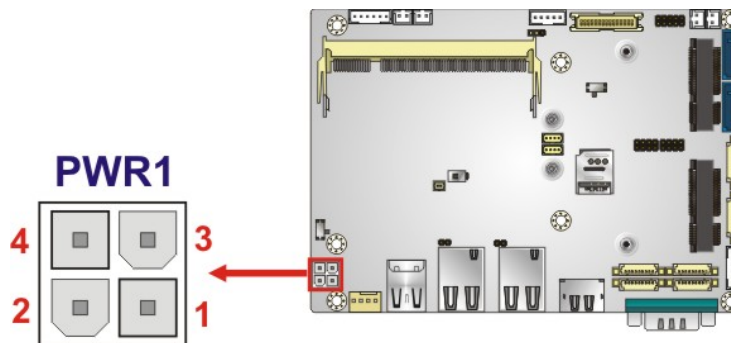

Figure 3-2: +12V DC-IN Power Connector Location

PIN NO.	DESCRIPTION	PIN NO.	DESCRIPTION
1	GND	2	GND
3	+12V	4	+12V

Table 3-3: +12V DC-IN Power Connector Pinouts

3.2.2 Audio Connector

- CN Label:** AUDIO1
- CN Type:** 10-pin header, p=2.00 mm
- CN Location:** See **Figure 3-3**
- CN Pinouts:** See **Table 3-4**

The audio connector is connected to external audio devices including speakers and microphones for the input and output of audio signals to and from the system.

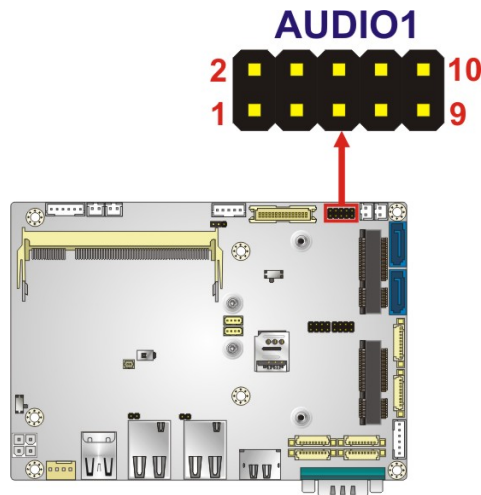

Figure 3-3: Audio Connector Location

PIN NO.	DESCRIPTION	PIN NO.	DESCRIPTION
1	LINE-OUT_R	2	LINE-IN_R
3	AUD_GND	4	AUD_GND
5	LINE-OUT_L	6	LINE-IN_L
7	AUD_GND	8	AUD_GND
9	MIC_R	10	MIC_L

Table 3-4: Audio Connector Pinouts

WAFER-BW SBC

3.2.3 Battery Connector



CAUTION:

Risk of explosion if battery is replaced by an incorrect type. Only certified engineers should replace the on-board battery.

Dispose of used batteries according to instructions and local regulations.

- CN Label:** BT1
- CN Type:** 2-pin wafer, p=1.25 mm
- CN Location:** See **Figure 3-4**
- CN Pinouts:** See **Table 3-5**

The battery connector is connected to the system battery. The battery provides power to the system clock to retain the time when power is turned off.

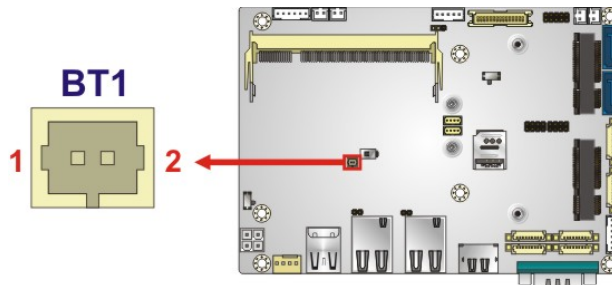

Figure 3-4: Battery Connector Location

Pin	Description
1	VBAT+
2	GND

Table 3-5: Battery Connector Pinouts

3.2.4 Digital I/O Connector

- CN Label:** DIO1
- CN Type:** 10-pin wafer, p=1.25 mm
- CN Location:** See **Figure 3-5**
- CN Pinouts:** See **Table 3-6**

The 8-bit digital I/O connector provides programmable input and output for external devices.

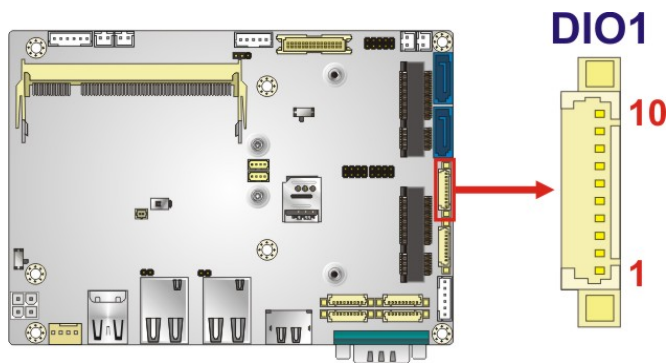

Figure 3-5: Digital I/O Connector Location

PIN NO.	DESCRIPTION	PIN NO.	DESCRIPTION
1	GND	2	+5V
3	DOUT3	4	DOUT2
5	DOUT1	6	DOUT0
7	DIN3	8	DIN2
9	DIN1	10	DIN0

Table 3-6: Digital I/O Connector Pinouts

WAFER-BW SBC

3.2.5 Fan Connector

- CN Label:** CPU_FAN1
- CN Type:** 4-pin wafer, p=2.54 mm
- CN Location:** See **Figure 3-6**
- CN Pinouts:** See **Table 3-7**

The fan connector attaches to a cooling fan.

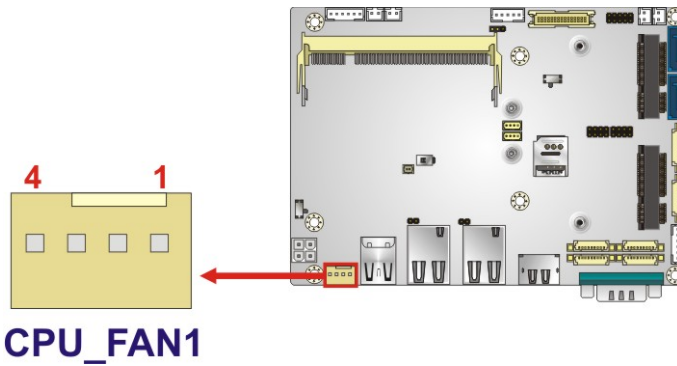

Figure 3-6: Fan Connector Location

Pin	Description
1	GND
2	+V12S
3	Rotation Signal
4	PWM Control Signal

Table 3-7: Fan Connector Pinouts

3.2.6 I²C Connector

- CN Label:** J_I2C1
- CN Type:** 4-pin wafer, p=1.25 mm
- CN Location:** See **Figure 3-7**
- CN Pinouts:** See **Table 3-8**

The I²C connector is used to connect I²C-bus devices to the main board.

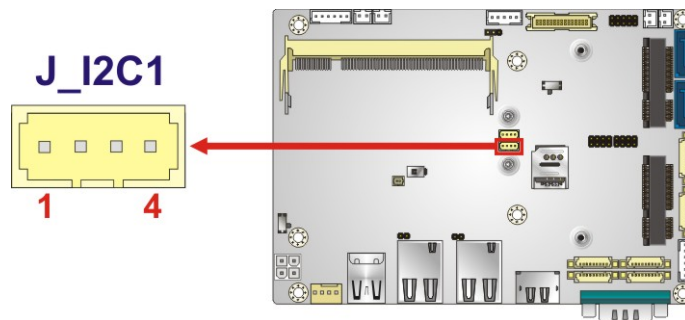

Figure 3-7: I²C Connector Location

Pin	Description
1	GND
2	I ² C _DATA
3	I ² C _CLK
4	+5V

Table 3-8: I²C Connector Pinouts

WAFER-BW SBC

3.2.7 Keyboard and Mouse Connector

- CN Label:** J_KB/MS1
- CN Type:** 6-pin wafer, p=2.00 mm
- CN Location:** See **Figure 3-8**
- CN Pinouts:** See **Table 3-9**

The keyboard/mouse connector connects to a PS/2 Y-cable that can be connected to a PS/2 keyboard and mouse.

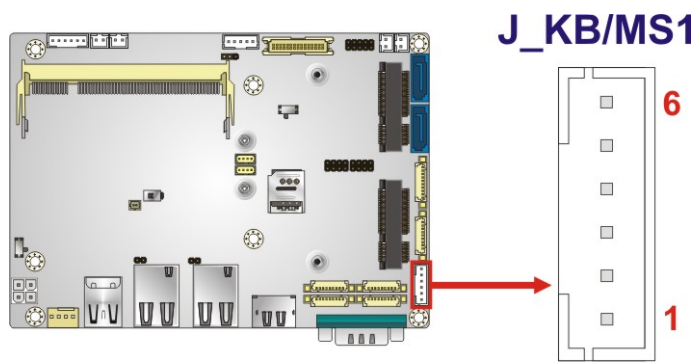

Figure 3-8: Keyboard and Mouse Connector Location

Pin	Description
1	VCC5V
2	Mouse Data
3	Mouse Clock
4	Keyboard Data
5	Keyboard Clock
6	GND

Table 3-9: Keyboard and Mouse Connector Pinouts

3.2.8 LVDS Backlight Inverter Connector

- CN Label:** INV1
- CN Type:** 5-pin wafer, p=2.00 mm
- CN Location:** See **Figure 3-9**
- CN Pinouts:** See **Table 3-10**

The backlight inverter connector provides power to an LCD panel.

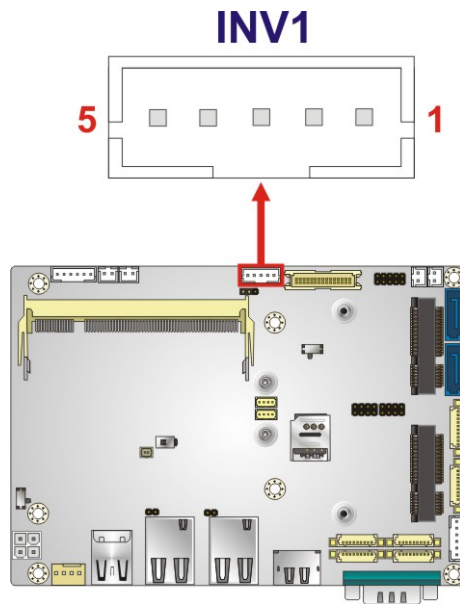

Figure 3-9: Backlight Inverter Connector Location

Pin	Description
1	LCD_BKLTCTL
2	GND
3	+12V
4	GND
5	BACKLIGHT ENABLE

Table 3-10: Backlight Inverter Connector Pinouts

WAFER-BW SBC

3.2.9 LVDS LCD Connector

- CN Label:** LVDS1
- CN Type:** 30-pin crimp, p=1.25 mm
- CN Location:** See **Figure 3-10**
- CN Pinouts:** See **Table 3-11**

The LVDS connector is for an LCD panel connected to the board.

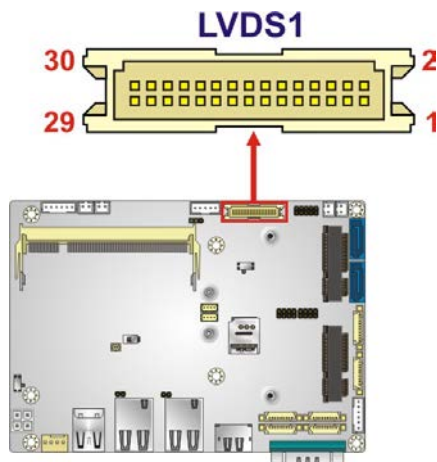

Figure 3-10: LVDS Connector Location

Pin	Description	Pin	Description
1	GROUND	2	GROUND
3	LVDS_A_TX0-P	4	LVDS_A_TX0-N
5	LVDS_A_TX1-P	6	LVDS_A_TX1-N
7	LVDS_A_TX2-P	8	LVDS_A_TX2-N
9	LVDS_A_TXCLK-P	10	LVDS_A_TXCLK-N
11	LVDS_A_TX3-P	12	LVDS_A_TX3-N
13	GROUND	14	GROUND
15	LVDS_B_TX0-P	16	LVDS_B_TX0-N
17	LVDS_B_TX1-P	18	LVDS_B_TX1-N
19	LVDS_B_TX2-P	20	LVDS_B_TX2-N
21	LVDS_B_TXCLK-P	22	LVDS_B_TXCLK-N
23	LVDS_B_TX3-P	24	LVDS_B_TX3-N
25	GROUND	26	GROUND

Pin	Description	Pin	Description
27	+LCD VCC	28	+LCD VCC
29	+LCD VCC	30	+LCD VCC

Table 3-11: LVDS Connector Pinouts

3.2.10 LAN LED Connectors

CN Label: JLAN_LED1, JLAN_LED2

CN Type: 2-pin header, p=2.00 mm

CN Location: See **Figure 3-11**

CN Pinouts: See **Table 3-12**

The LAN LED connectors connect to the LAN link LEDs on the system.

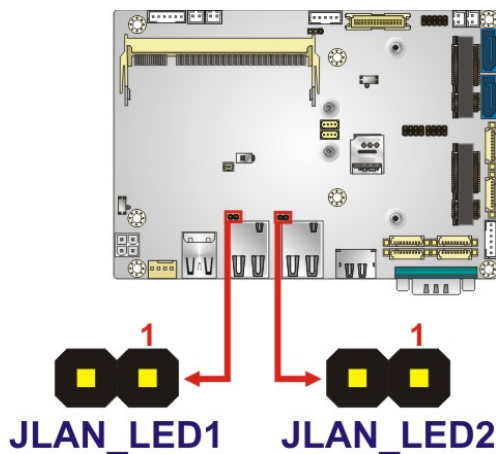

Figure 3-11: LAN LED Connector Locations

Pin	Description
1	+3.3VLAN
2	LAN_LED_LINK#

Table 3-12: LAN LED Connector Pinouts

WAFER-BW SBC

3.2.11 mSATA Module Slot



CAUTION:

If an mSATA module is installed in the mSATA slot (MINI_PCIE2), the SATA port 2 (SATA2) will be disabled. Choose either the SATA2 connector or the mSATA module for storage.

- CN Label:** MINI_PCIE2
- CN Type:** Half-size/Full-size PCIe Mini card slot
- CN Location:** See **Figure 3-12**
- CN Pinouts:** See **Table 3-13**

The PCIe Mini card slot supports mSATA modules or PCIe Mini cards with USB interface.

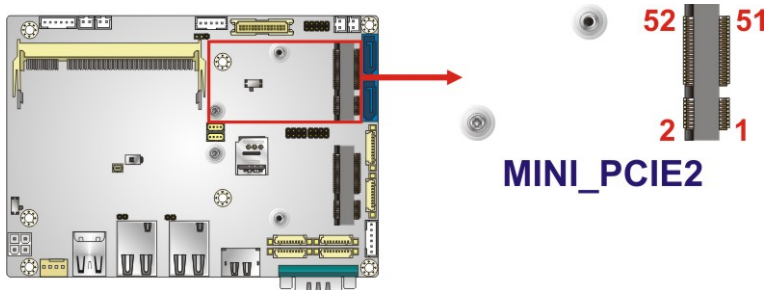

Figure 3-12: mSATA Module Slot Location

Pin	Description	Pin	Description
1	PCIE_WAKE#	2	VCC3
3	N/C	4	GND
5	N/C	6	1.5V
7	N/C	8	N/C
9	GND	10	N/C
11	PCIE_CLK#	12	N/C
13	PCIE_CLK	14	N/C
15	GND	16	N/C
17	N/C	18	GND

Pin	Description	Pin	Description
19	N/C	20	N/C
21	GND	22	PCIRST#
23	PCIE_RXN(SATA_RX+)	24	N/C
25	PCIE_RXP(SATA_RX-)	26	GND
27	GND	28	1.5V
29	GND	30	SMBCLK
31	PCIE_TXN(SATA_TX-)	32	SMBDATA
33	PCIE_TXP(SATA_TX+)	34	GND
35	GND	36	USB D-
37	GND	38	USB D+
39	VCC3	40	GND
41	VCC3	42	N/C
43	GND	44	N/C
45	N/C	46	N/C
47	N/C	48	1.5V
49	N/C	50	GND
51	N/C	52	VCC3

Table 3-13: mSATA Module Slot Pinouts

3.2.12 PCIe Mini Card Slot

- CN Label:** MINI_PCIE1
- CN Type:** Half-size/Full-size PCIe Mini card slot
- CN Location:** See **Figure 3-13**
- CN Pinouts:** See **Table 3-14**

The PCIe Mini card slot is for installing a PCIe Mini expansion card with USB interface, such as 3G modules.

WAFER-BW SBC

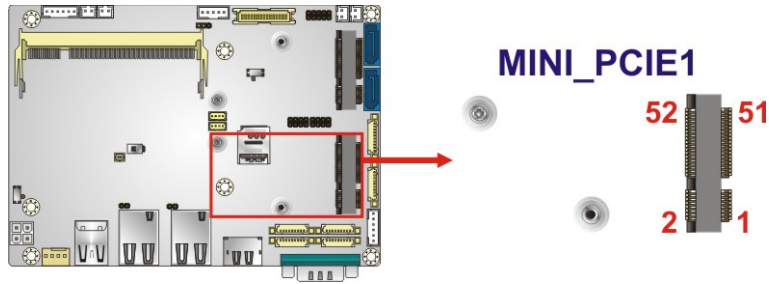

Figure 3-13: PCIe Mini Card Slot Location

Pin	Description	Pin	Description
1	PCIE_WAKE#	2	VCC3
3	N/C	4	GND
5	N/C	6	1.5V
7	N/C	8	UIM_PWR
9	GND	10	UIM_DATA
11	PCIE_CLK#	12	UIM_CLK
13	PCIE_CLK	14	UIM_RST
15	GND	16	UIM_VPP
17	N/C	18	GND
19	N/C	20	N/C
21	GND	22	PCIRST#
23	PCIE_RXN	24	N/C
25	PCIE_RXP	26	GND
27	GND	28	1.5V
29	GND	30	SMBCLK
31	PCIE_TXN	32	SMBDATA
33	PCIE_TXP	34	GND
35	GND	36	USBD-
37	GND	38	USBD+
39	VCC3	40	GND
41	VCC3	42	N/C
43	GND	44	N/C
45	N/C	46	N/C
47	N/C	48	1.5V

Pin	Description	Pin	Description
49	N/C	50	GND
51	N/C	52	VCC3

Table 3-14: PCIe Mini Card Slot Pinouts

3.2.13 Power and HDD LED Connector

- CN Label:** CN1
- CN Type:** 6-pin wafer, p=2.00 mm
- CN Location:** See **Figure 3-14**
- CN Pinouts:** See **Table 3-15**

The CN1 connector connects to power and HDD LED indicators.

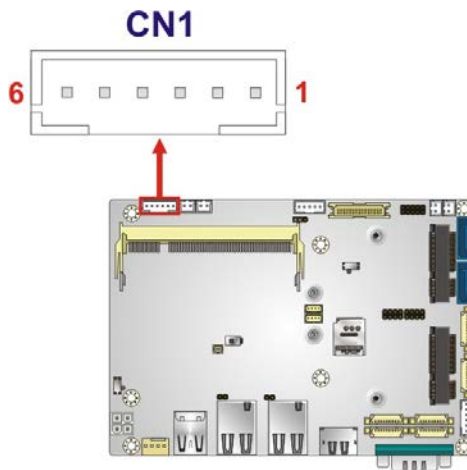

Figure 3-14: Power and HDD LED Connector Location

Pin	Description	
1	VCC	+5V
2	GND	
3	PWR_LED+	Power LED
4	PWR_LED-	
5	HDD_LED+	HDD LED
6	HDD_LED-	

Table 3-15: Power and HDD LED Connector Pinouts

WAFER-BW SBC

3.2.14 Power Button Connector

- CN Label:** PWR_BTN1
- CN Type:** 2-pin wafer, p=2.00 mm
- CN Location:** See Figure 3-15
- CN Pinouts:** See Table 3-16

The power button connector connects to a power button.

PWR_BTN1

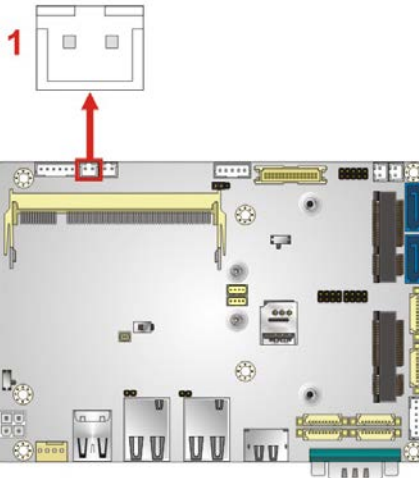

Figure 3-15: Power Button Connector Location

Pin	Description
1	PWR_BTN+
2	PWR_BTN-

Table 3-16: Power Button Connector Pinouts

3.2.15 Reset Button Connector

- CN Label:** RST_BTN1
- CN Type:** 2-pin wafer, p=2.00 mm
- CN Location:** See Figure 3-16
- CN Pinouts:** See Table 3-17

The reset button connector connects to a reset button.

RST_BTN1

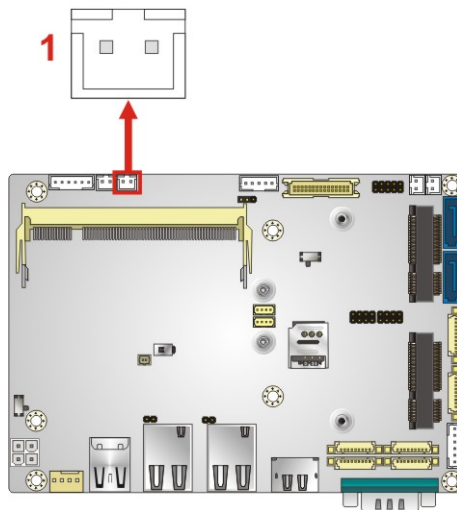

Figure 3-16: Reset Button Connector Location

Pin	Description
1	RESET+
2	RESET-

Table 3-17: Reset Button Connector Pinouts

WAFER-BW SBC

3.2.16 RS-232 Serial Port Connectors

- CN Label:** COM2, COM3, COM5
- CN Type:** 9-pin wafer, p=1.25 mm
- CN Location:** See **Figure 3-17**
- CN Pinouts:** See **Table 3-18**

The serial connectors provide RS-232 connection.

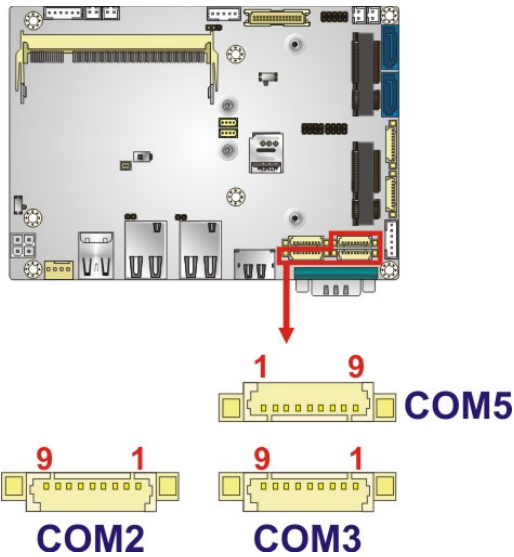

Figure 3-17: RS-232 Serial Port Connector Locations

PIN NO.	DESCRIPTION	PIN NO.	DESCRIPTION
1	DCD	2	DSR
3	RXD	4	RTS
5	TXD	6	CTS
7	DTR	8	RI
9	GND		

Table 3-18: RS-232 Serial Port Connector Pinouts

3.2.17 RS-232/422/485 Serial Port Connectors

- CN Label:** COM4, COM6
- CN Type:** 9-pin wafer, p=1.25 mm
- CN Location:** See **Figure 3-18**
- CN Pinouts:** See **Table 3-19**

These two connectors provide RS-232, RS-422 or RS-485 communications. The default mode is set to RS-232 in BIOS. To configure the connectors as RS-422 or RS-485, please refer to **Section 5.3.4.1.4** and **Section 5.3.4.1.6**.

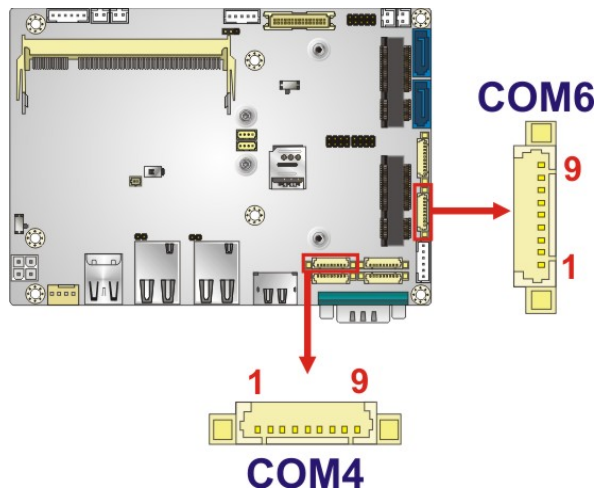

Figure 3-18: RS-232/422/485 Connector Locations

Pin	RS-232	RS-422	RS-485
1	DCD	TXD-	DATA-
2	DSR	--	--
3	RXD	TXD+	DATA+
4	RTS	--	--
5	TXD	RXD+	--
6	CTS	--	--
7	DTR	RXD-	--
8	RI	--	--
9	GND	--	--

Table 3-19: RS-232/422/485 Connector Pinouts

WAFER-BW SBC

Use the optional RS-422/485 cable to connect to a serial device. The pinouts of the DB-9 connector are listed below.

RS-422 Pinouts	RS-485 Pinouts

Table 3-20: DB-9 RS-422/485 Pinouts

3.2.18 SATA 6Gb/s Connectors

- CN Label:** SATA1, SATA2
- CN Type:** 7-pin SATA connector
- CN Location:** See **Figure 3-19**

The SATA 6Gb/s connector is connected to a SATA 6Gb/s device. The SATA 6Gb/s device transfers data at speeds as high as 6Gb/s.

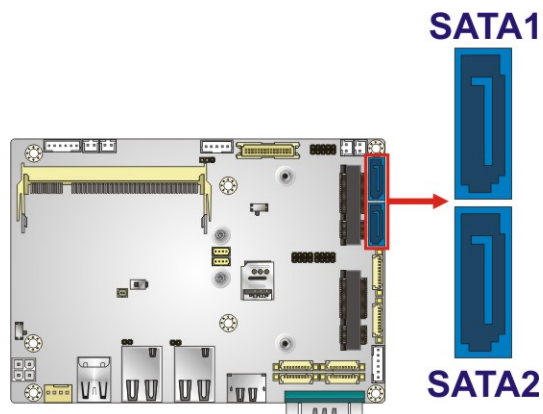

Figure 3-19: SATA 6Gb/s Connector Locations



CAUTION:

If an mSATA module is installed in the mSATA slot (MINI_PCIE2), the SATA port 2 (SATA2) will be disabled. Choose either the SATA2 connector or the mSATA module for storage.

3.2.19 SATA Power Connectors

CN Label: SATA_PWR1, SATA_PWR2

CN Type: 2-pin wafer, p=2.00 mm

CN Location: See **Figure 3-20**

CN Pinouts: See **Table 3-21**

The SATA power connector provides +5 V power output to the SATA connector.

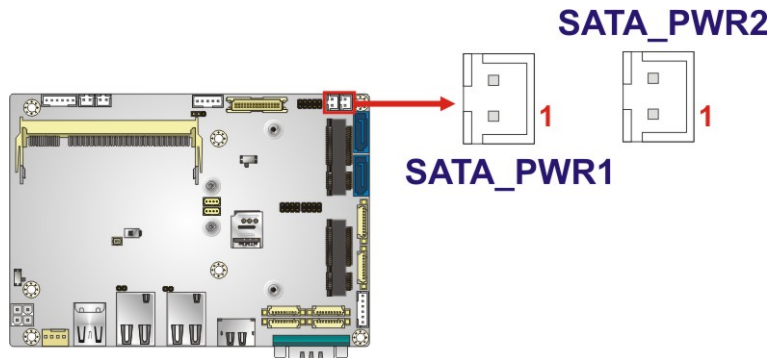

Figure 3-20: SATA Power Connector Locations

Pin	Description
1	+5V
2	GND

Table 3-21: SATA Power Connector Pinouts

WAFER-BW SBC

3.2.20 SIM Card Slot

- CN Label:** SIM1
CN Type: Micro SIM card slot
CN Location: See **Figure 3-21**

The SIM card slot accepts a micro SIM card for network communication.

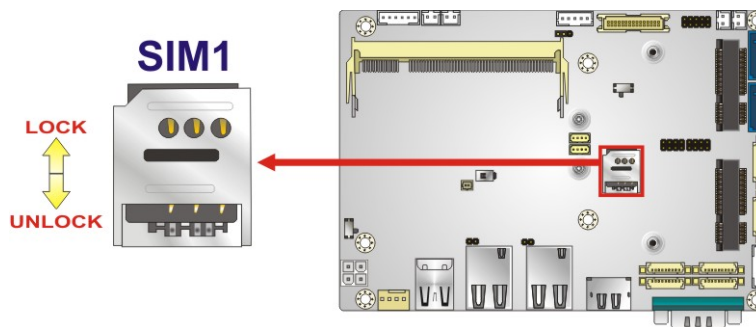

Figure 3-21: SIM Card Slot Location

3.2.21 SMBus Connector

- CN Label:** J_SMB1
CN Type: 4-pin wafer, p=1.25 mm
CN Location: See **Figure 3-22**
CN Pinouts: See **Table 3-22**

The SMBus (System Management Bus) connector provides low-speed system management communications.

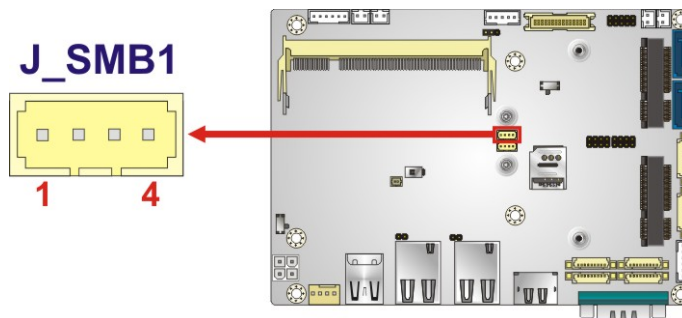

Figure 3-22: SMBus Connector Location

Pin	Description
1	GND
2	SMB_DATA
3	SMB_CLK
4	+5V

Table 3-22: SMBus Connector Pinouts

3.2.22 USB Connectors

- CN Label:** USB2, USB3
- CN Type:** 8-pin header, p=2.00 mm
- CN Location:** See Figure 3-23
- CN Pinouts:** See Table 3-23

The USB connectors provide four USB 2.0 ports by dual-port USB cable.

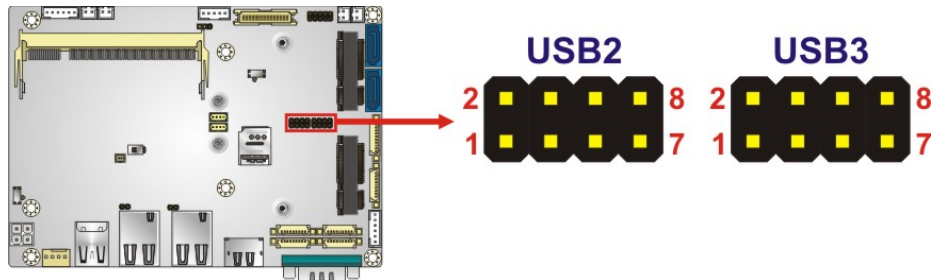

Figure 3-23: USB Connector Locations

PIN NO.	DESCRIPTION	PIN NO.	DESCRIPTION
1	USB_VCC	2	GND
3	DATA-	4	DATA+
5	DATA+	6	DATA-
7	GND	8	USB_VCC

Table 3-23: USB Connector Pinouts

WAFER-BW SBC

3.3 External Peripheral Interface Connector Panel

Figure 3-24 shows the WAFER-BW external peripheral interface connector (EPIC) panel. The EPIC panel consists of the following:

- 2 x HDMI connector
- 2 x GbE LAN connector
- 1 x RS-232 serial port connector
- 2 x USB 3.0 connector

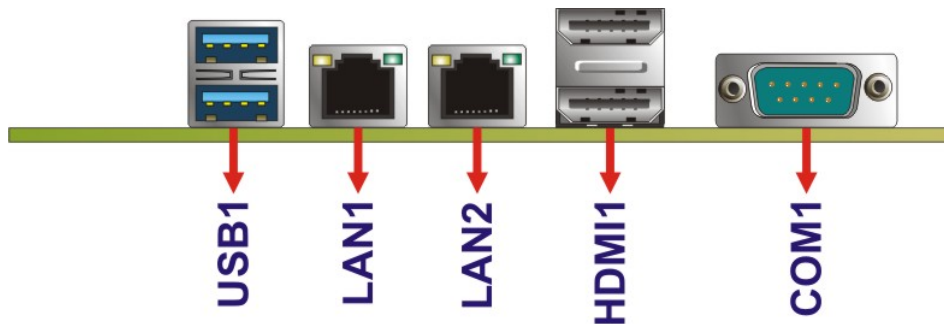

Figure 3-24: External Peripheral Interface Connector

3.3.1 HDMI Connectors

- CN Label:** HDMI1
- CN Type:** HDMI connector
- CN Location:** See **Figure 3-24**
- CN Pinouts:** See **Table 3-24**

The HDMI connector can connect to an HDMI device. The HDMI connectors support up to 3840x2160 resolution at 30 Hz.

Pin	Description	Pin	Description
1	HDMI_DATA2	2	GND
3	HDMI_DATA2#	4	HDMI_DATA1
5	GND	6	HDMI_DATA1#
7	HDMI_DATA0	8	GND
9	HDMI_DATA0#	10	HDMI_CLK
11	GND	12	HDMI_CLK#

Pin	Description	Pin	Description
13	N/A	14	N/A
15	HDPMI_SCL	16	HDPMI_SDA
17	GND	18	+5V
19	HDPMI_HPD	20	HDMI_GND

Table 3-24: HDMI Connector Pinouts

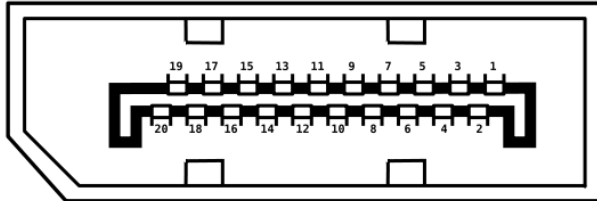

Figure 3-25: HDMI Connector Pinout Locations

3.3.2 LAN Connectors

CN Label: LAN1, LAN2

CN Type: RJ-45

CN Location: See **Figure 3-24**

CN Pinouts: See **Figure 3-26** and **Table 3-25**

The LAN connector connects to a local network.

Pin	Description	Pin	Description
1	LAN_MDIO+	7	LAN_MDI2+
2	LAN_MDIO-	8	LAN_MDI2-
3	LAN_MDI1+	9	LAN_MDI3+
4	LAN_MDI1-	10	LAN_MDI3-

Table 3-25: LAN Pinouts

WAFER-BW SBC

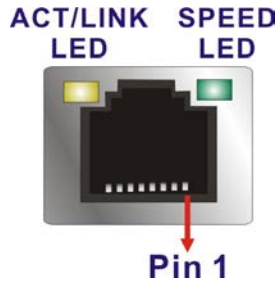

Figure 3-26: LAN Connector

3.3.3 Serial Port Connector (COM1)

- CN Label:** COM1
- CN Type:** 9-pin male D-sub
- CN Location:** See **Figure 3-24**
- CN Pinouts:** See **Table 3-26**

The serial port connects to a RS-232 serial communications device.

Pin	Description	Pin	Description
1	DCD	6	DSR
2	RX	7	RTS
3	TX	8	CTS
4	DTR	9	RI
5	GND		

Table 3-26: Serial Port Pinouts

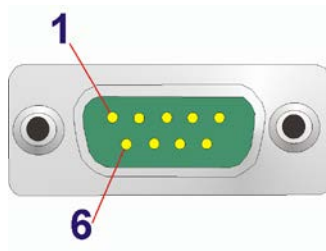

Figure 3-27: Serial Port Pinout Locations

3.3.4 USB Connectors

- CN Label:** USB1
- CN Type:** USB 3.0 ports
- CN Location:** See **Figure 3-24**
- CN Pinouts:** See **Table 3-27**

The WAFER-BW has two external USB 3.0 ports. The USB connector can be connected to a USB 2.0 or USB 3.0 device. The pinouts of USB 3.0 connectors are shown below.

Pin	Description	Pin	Description
1	USB_VCC	10	USB_VCC
2	USB2_D0-	11	USB2_D0-
3	USB2_D0+	12	USB2P0_D0+
4	GND	13	GND
5	USB3P0_RXDN1	14	USB3P0_RXDN2
6	USB3P0_RXDP1	15	USB3P0_RXDP2
7	GND	16	GND
8	USB3P0_TXDN1	17	USB3P0_TXDN2
9	USB3P0_TXDP1	18	USB3P0_TXDP2

Table 3-27: USB 3.0 Port Pinouts

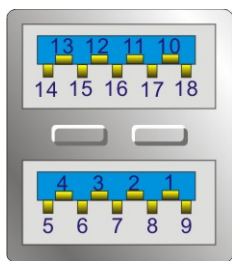

Figure 3-28: USB 3.0 Port Pinout Locations

Chapter

4

Installation

4.1 Anti-static Precautions



WARNING:

Failure to take ESD precautions during the installation of the WAFER-BW may result in permanent damage to the WAFER-BW and severe injury to the user.

Electrostatic discharge (ESD) can cause serious damage to electronic components, including the WAFER-BW. Dry climates are especially susceptible to ESD. It is therefore critical that whenever the WAFER-BW or any other electrical component is handled, the following anti-static precautions are strictly adhered to.

- **Wear an anti-static wristband:** Wearing a simple anti-static wristband can help to prevent ESD from damaging the board.
- **Self-grounding** Before handling the board, touch any grounded conducting material. During the time the board is handled, frequently touch any conducting materials that are connected to the ground.
- **Use an anti-static pad:** When configuring the WAFER-BW, place it on an anti-static pad. This reduces the possibility of ESD damaging the WAFER-BW.
- **Only handle the edges of the PCB:** When handling the PCB, hold the PCB by the edges.

4.2 Installation Considerations



NOTE:

The following installation notices and installation considerations should be read and understood before installation. All installation notices must be strictly adhered to. Failing to adhere to these precautions may lead to severe damage and injury to the person performing the installation.

WAFER-BW SBC



WARNING:

The installation instructions described in this manual should be carefully followed in order to prevent damage to the WAFER-BW, WAFER-BW components and injury to the user.

Before and during the installation please **DO** the following:

- Read the user manual:
 - The user manual provides a complete description of the WAFER-BW installation instructions and configuration options.
- Wear an electrostatic discharge cuff (ESD):
 - Electronic components are easily damaged by ESD. Wearing an ESD cuff removes ESD from the body and helps prevent ESD damage.
- Place the WAFER-BW on an antistatic pad:
 - When installing or configuring the motherboard, place it on an antistatic pad. This helps to prevent potential ESD damage.
- Turn all power to the WAFER-BW off:
 - When working with the WAFER-BW, make sure that it is disconnected from all power supplies and that no electricity is being fed into the system.

Before and during the installation of the WAFER-BW **DO NOT**:

- Remove any of the stickers on the PCB board. These stickers are required for warranty validation.
- Use the product before verifying all the cables and power connectors are properly connected.
- Allow screws to come in contact with the PCB circuit, connector pins, or its components.

4.3 SO-DIMM Installation



CAUTION:

1. DDR3L 1333 MHz operation will be downgraded to 1066 MHz due to Intel® SoC limitation.
2. In some cases, the WAFER-BW with DDR3L 1333 MHz memory module installed may take a longer time to boot up.

To install an SO-DIMM, please follow the steps below and refer to **Figure 4-1**.

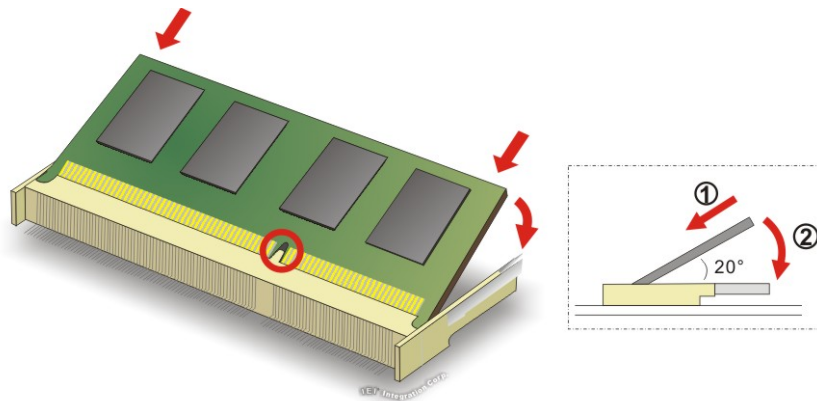

Figure 4-1: SO-DIMM Installation

- Step 1:** Locate the SO-DIMM socket. Place the board on an anti-static mat.
- Step 2:** Align the SO-DIMM with the socket. Align the notch on the memory with the notch on the memory socket.
- Step 3:** Insert the SO-DIMM. Push the memory in at a 20° angle. (See **Figure 4-1**)
- Step 4:** Seat the SO-DIMM. Gently push downwards and the arms clip into place. (See **Figure 4-1**)

4.4 mSATA Module Installation



CAUTION:

If an mSATA module is installed in the mSATA slot (MINI_PCIE2), the SATA port 2 (SATA2) will be disabled. Choose either the SATA2 connector or the mSATA module for storage.

The full-size/half-size PCIe Mini card slot (MINI_PCIE2) allows installation of an mSATA module. To install an mSATA module, please follow the steps below.

4.4.1 Full-size mSATA Module Installation

To install a full-size mSATA module, please follow the steps below.

Step 1: Locate the PCIe Mini slot (MINI_PCIE2). See **Chapter 3**.

Step 2: Remove the retention screw as shown in **Figure 4-2**.

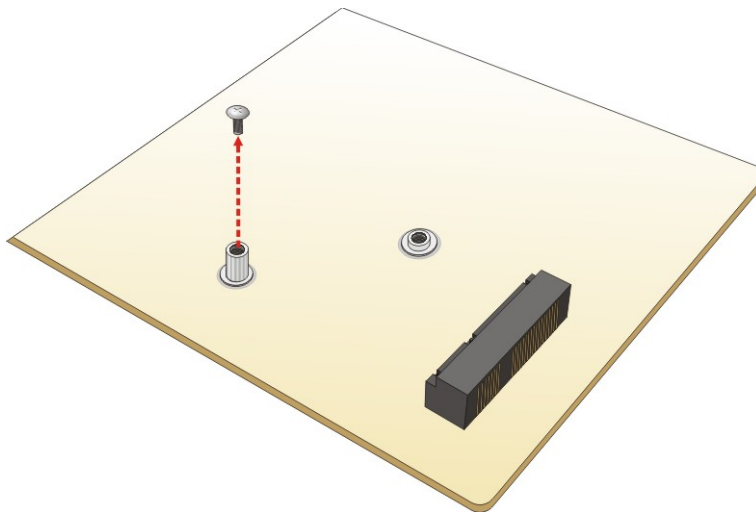

Figure 4-2: Removing the Retention Screw

Step 3: Line up the notch on the mSATA module with the notch on the slot. Slide the mSATA module into the socket at an angle of about 20° (**Figure 4-3**).

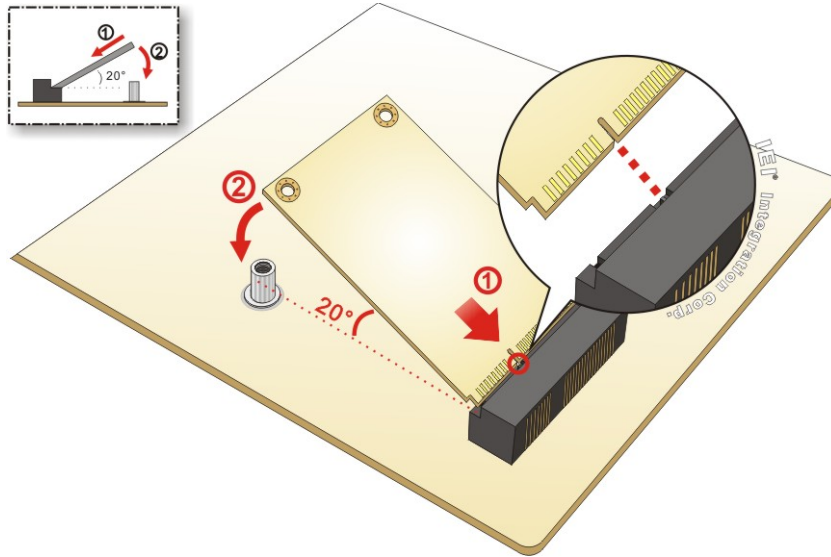

Figure 4-3: Inserting the Full-size mSATA Module into the Slot at an Angle

Step 4: Secure the mSATA module with the retention screw previously removed (Figure 4-4).

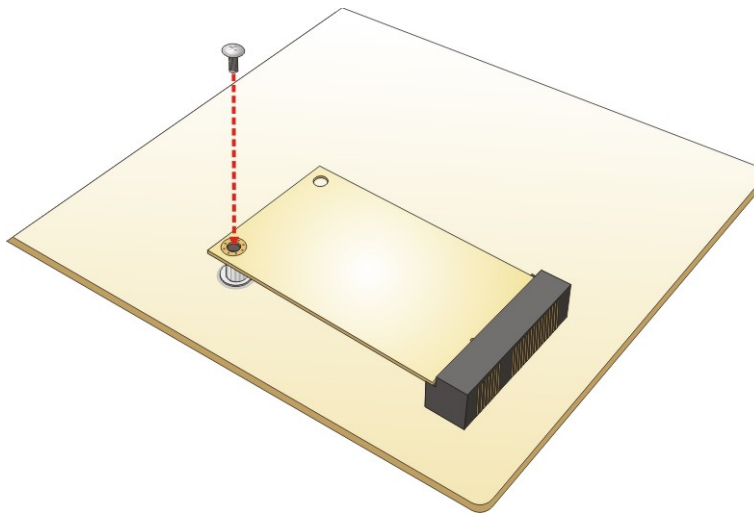

Figure 4-4: Securing the mSATA Module

4.4.2 Half-size mSATA Module Installation

To install a half-size mSATA module, please follow the steps below.

Step 1: Locate the PCIe Mini card slot (MINI_PCIE2). See **Chapter 3**.

WAFER-BW SBC

Step 2: Remove the retention screw. Unscrew and remove the standoff secured on the motherboard. See **Figure 4-5**.

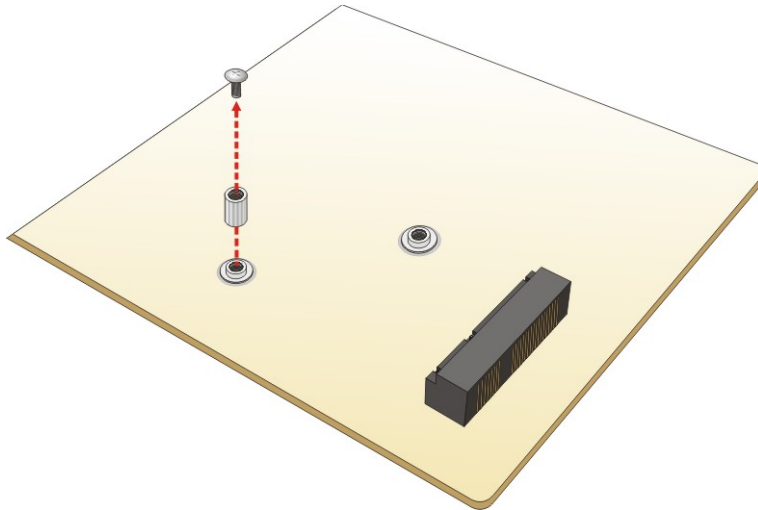

Figure 4-5: Removing the Retention Screw and the Standoff

Step 3: Install the previously removed standoff to the screw hole for the half-size mSATA module (**Figure 4-6**).

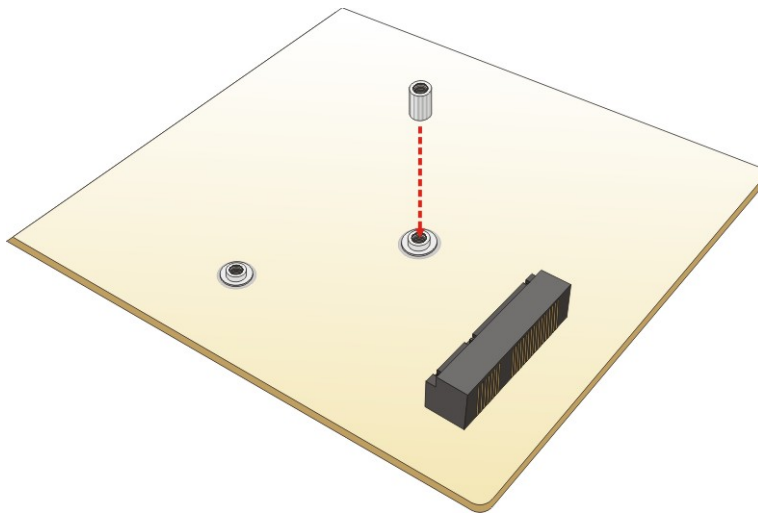

Figure 4-6: Installing the Standoff

Step 4: Line up the notch on the card with the notch on the slot. Slide the mSATA module into the slot at an angle of about 20° (**Figure 4-7**).

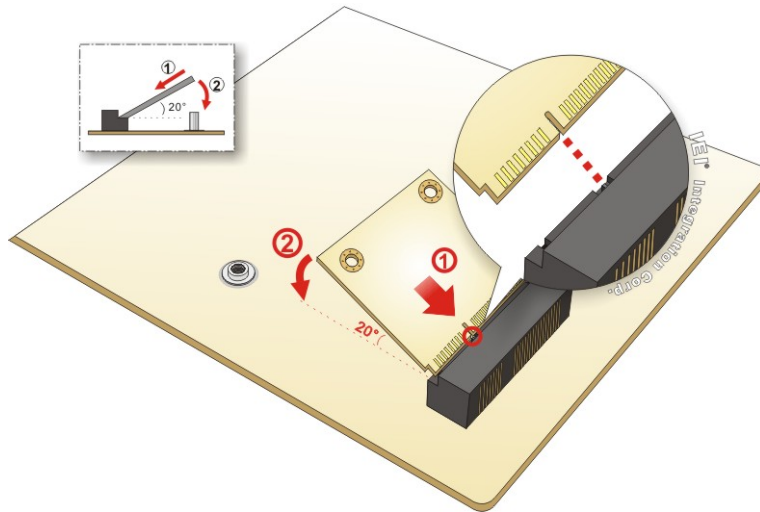

Figure 4-7: Inserting the Half-size mSATA Module into the Slot at an Angle

Step 5: Secure the half-size mSATA module with the retention screw previously removed (**Figure 4-8**).

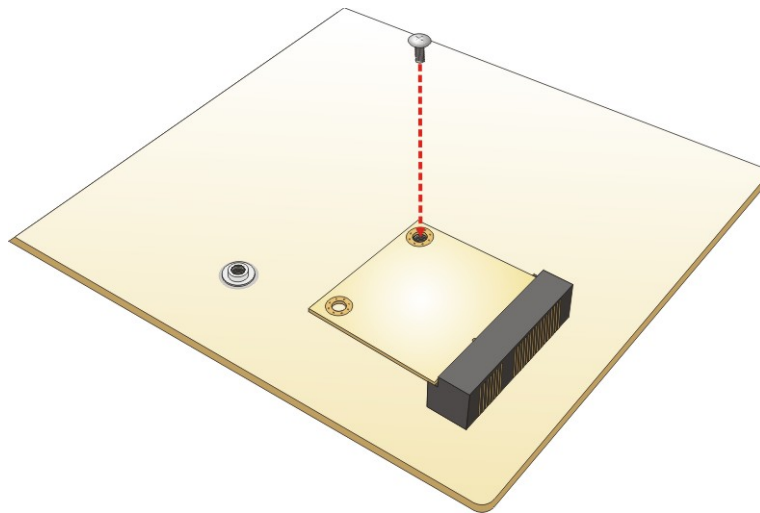

Figure 4-8: Securing the Half-size mSATA Module

4.5 PCIe Mini Card Installation

The PCIe Mini card slot (MINI_PCIE1) allows installation of either a full-size or half-size PCIe Mini card. To install a full-size PCIe Mini card, please refer to the steps described in **Section 4.4** above.

WAFER-BW SBC

4.6 System Configuration

The system configuration is controlled by buttons, jumpers and switches. The system configuration should be performed before installation.

4.6.1 AT/ATX Mode Select Switch

CN Label:	J_ATX_AT1
CN Type:	Switch
CN Location:	See Figure 4-9
CN Settings:	See Table 4-1

The AT/ATX mode select switch specifies the systems power mode as AT or ATX. AT/ATX mode select switch settings are shown in **Table 4-1**.

Setting	Description
Short 1-2	ATX Mode (Default)
Short 2-3	AT Mode

Table 4-1: AT/ATX Mode Select Switch Settings

The location of the AT/ATX mode select switch is shown in **Figure 4-9** below.

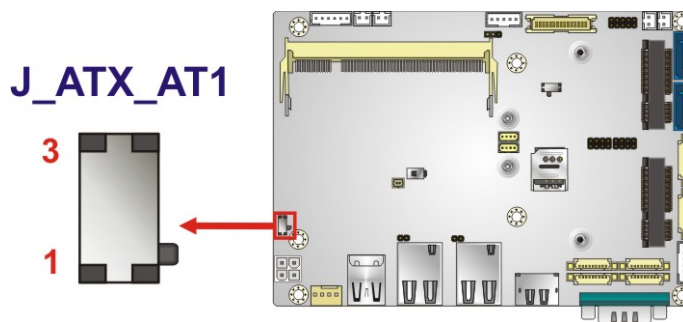

Figure 4-9: AT/ATX Mode Select Switch Location

4.6.2 Clear CMOS Button

CN Label:	J_CMOS1
CN Type:	Button
CN Location:	See Figure 4-10

If the WAFER-BW fails to boot due to improper BIOS settings, use the button to clear the CMOS data and reset the system BIOS information.

The location of the clear CMOS button is shown in **Figure 4-10**

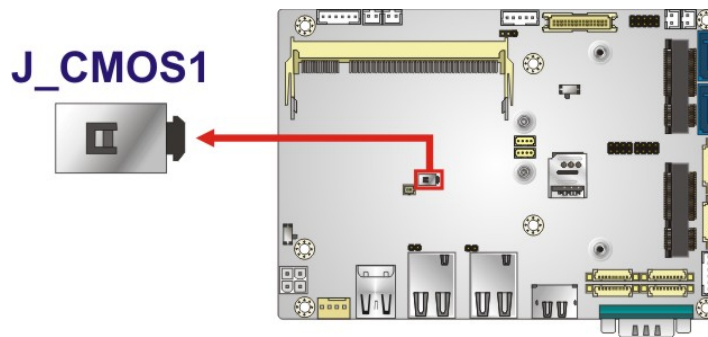

Figure 4-10: Clear CMOS Button Location

WAFER-BW SBC

4.6.3 Flash Descriptor Security Override Switch

- CN Label:** J_TXE1
- CN Type:** Switch
- CN Location:** See Figure 4-9
- CN Settings:** See Table 4-1

The Flash Descriptor Security Override jumper allows users to enable or disable the TXE update. The settings are shown in **Table 4-1**.

Setting	Description
Short 1-2	Disabled (Default)
Short 2-3	Enabled

Table 4-2: Flash Descriptor Security Override Switch Settings

The location of the switch is shown in **Figure 4-9** below.

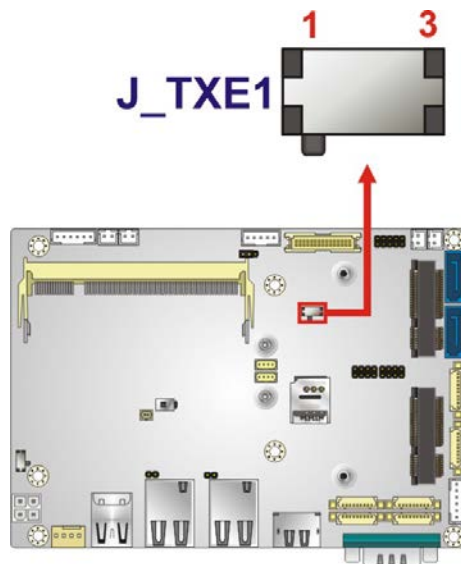

Figure 4-11: Flash Descriptor Security Override Switch Location

4.6.4 LVDS Voltage Select Jumper



WARNING:

Permanent damage to the screen and WAFER-BW may occur if the wrong voltage is selected with this jumper. Please refer to the user guide that came with the monitor to select the correct voltage.

- Jumper Label:** J_PW1
- Jumper Type:** 3-pin header, p=2.00 mm
- Jumper Settings:** See Table 4-3
- Jumper Location:** See Figure 4-12

The LVDS voltage selection jumper allows setting the voltage provided to the monitor connected to the LVDS connector.

Setting	Description
Short 1-2	+3.3 V (Default)
Short 2-3	+5 V

Table 4-3: LVDS Voltage Select Jumper Settings

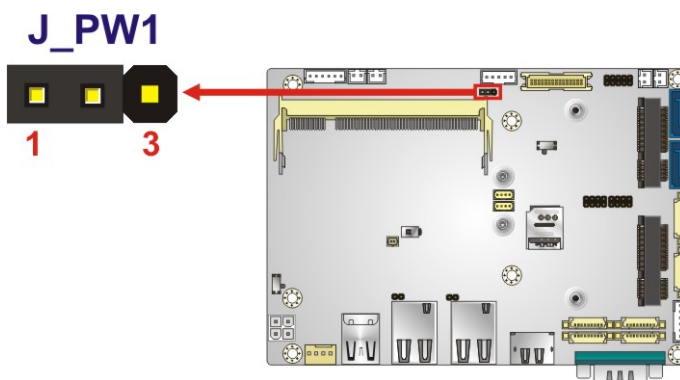

Figure 4-12: LVDS Voltage Select Jumper Location

WAFER-BW SBC

4.7 Motherboard Installation

4.7.1 Heat Spreader

**WARNING:**

The heat spreader installed on the WAFER-BW can only serve as a heat conductor which needs additional heat dissipation mechanism to achieve suitable thermal condition. DO NOT put the WAFER-BW with the heat spreader directly on a surface that cannot dissipate system heat, and never run the WAFER-BW without the heat spreader secured to the board.

When the WAFER-BW is shipped, it is secured to a heat spreader with five retention screws. The heat spreader must have a direct contact with a heat dissipation surface to ensure stable operation. In addition, a thin layer of thermal paste has to be applied onto the heat dissipation surface where it contacts the heat spreader. The following diagrams show an example of a heat sink module and how it can be installed for dissipating the heat generated from the motherboard:

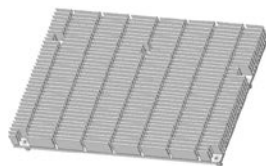
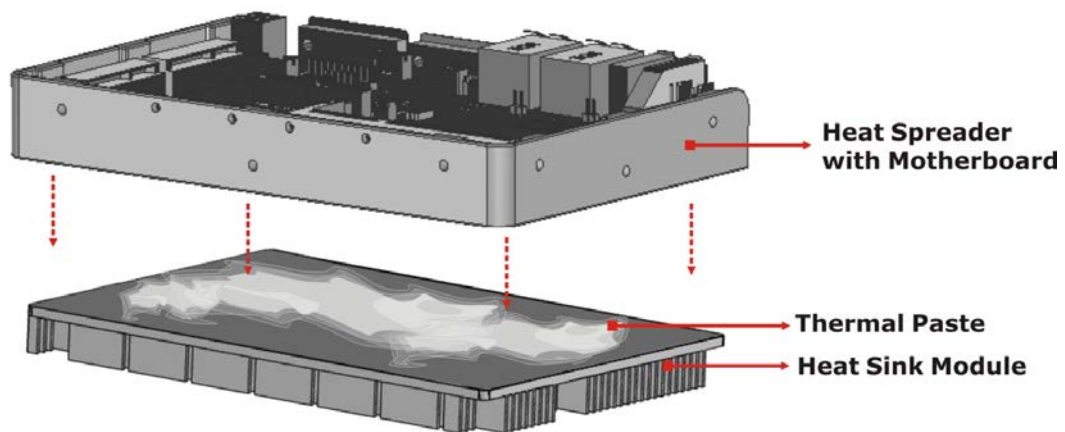
**Heat sink module:****Material:** Aluminum**Size:** 146 mm x 102 mm x 12 mm

If the WAFER-BW must be removed from the heat spreader, the five retention screws must be removed.

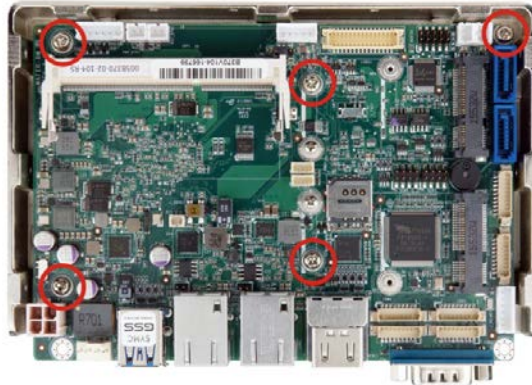

Figure 4-13: Heat Spreader Retention Screws

4.7.2 Motherboard Installation Example

Each side of the heat spreader has several screw holes allowing the WAFER-BW to be mounted into a chassis or a heat sink enclosure (please refer to Section 1.5 for the detailed dimensions). The user has to design or select a chassis or a heat sink enclosure that has screw holes matching up with the holes on the heat spreader for installing the WAFER-BW. The following diagram shows an example of motherboard installation.

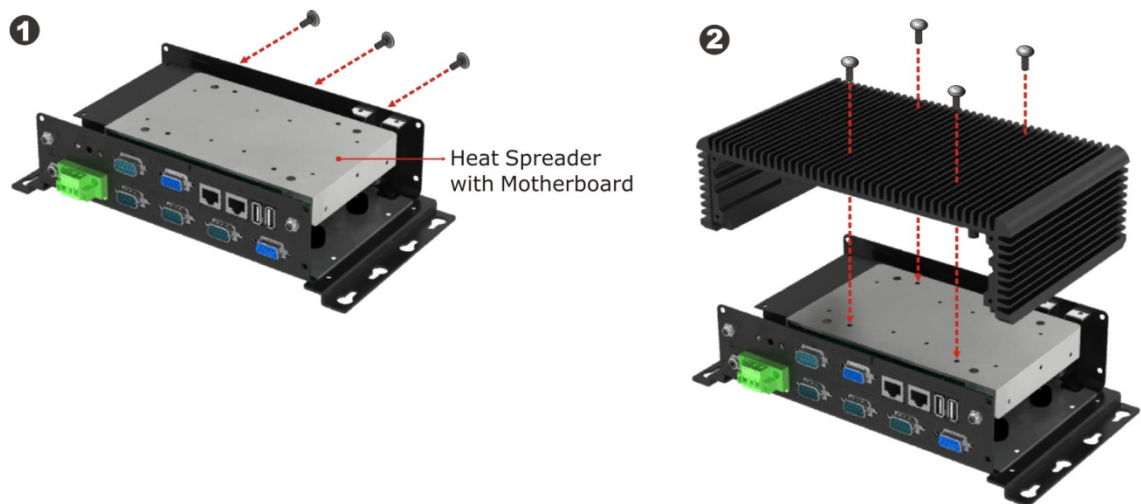

Figure 4-14: Motherboard Installation Example

WAFER-BW SBC

4.8 Internal Peripheral Device Connections

This section outlines the installation of peripheral devices to the onboard connectors.

4.8.1 Audio Kit Installation

The Audio Kit that came with the WAFER-BW connects to the audio connector on the WAFER-BW. The audio kit consists of three audio jacks. Mic-in connects to a microphone. Line-in provides a stereo line-level input to connect to the output of an audio device. Line-out, a stereo line-level output, connects to two amplified speakers. To install the audio kit, please refer to the steps below:

Step 1: **Locate the audio connector.** The location of the 10-pin audio connector is shown in **Chapter 3**.

Step 2: **Align pin 1.** Align pin 1 on the on-board connector with pin 1 on the audio kit connector. Pin 1 on the audio kit connector is indicated with a white dot. See Figure 4-15.

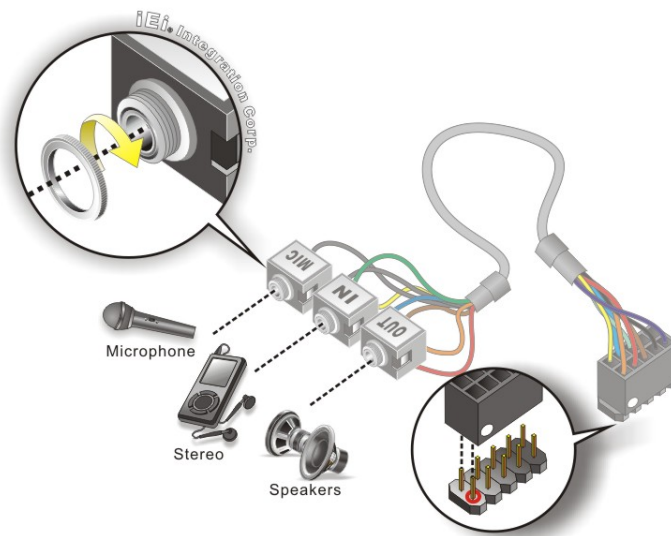

Figure 4-15: Audio Kit Cable Connection

Step 3: **Connect the audio devices.** Connect speakers to the line-out audio jack. Connect the output of an audio device to the line-in audio jack. Connect a microphone to the mic-in audio jack.

4.8.2 AT Power Connection

Follow the instructions below to connect the WAFER-BW to an AT power supply.



WARNING:

Disconnect the power supply power cord from its AC power source to prevent a sudden power surge to the WAFER-BW.

Step 1: Locate the power cable. The power cable is shown in the packing list in Chapter 2.

Step 2: Connect the Power Cable to the Motherboard. Connect the 4-pin (2x2) Molex type power cable connector to the AT power connector on the motherboard. See Figure 4-16.

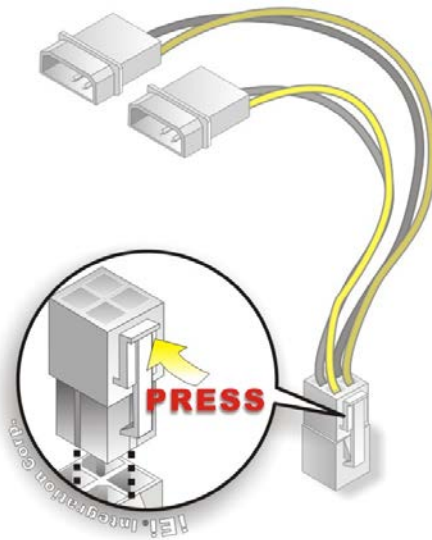

Figure 4-16: Power Cable to Motherboard Connection

Step 3: Connect Power Cable to Power Supply. Connect one of the 4-pin (1x4) Molex type power cable connectors to an AT power supply. See Figure 4-17.

WAFER-BW SBC

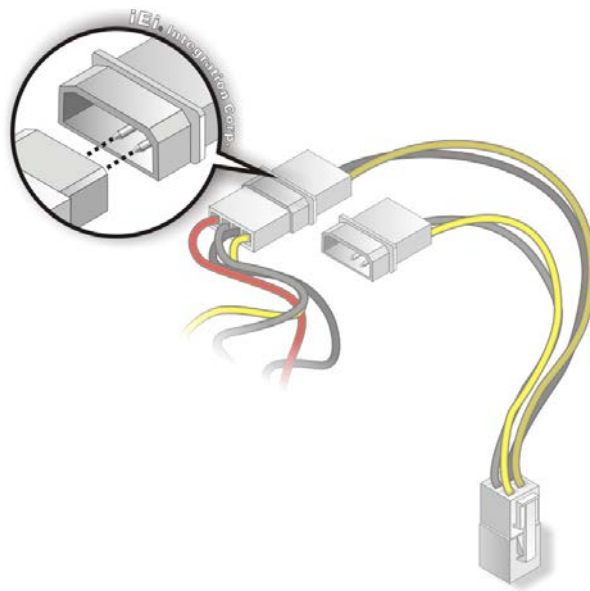

Figure 4-17: Connect Power Cable to Power Supply

4.8.3 SATA Drive Connection

The WAFER-BW is shipped with two SATA cables. To connect the SATA drive to the connector, please follow the steps below.

Step 1: Locate the SATA connector and the SATA power connector. The locations of the connectors are shown in **Chapter 3**.

Step 2: Insert the cable connector. Insert the cable connector into the on-board SATA drive connector and the SATA power connector. See **Figure 4-18**.



NOTE:

The connector locations in the following diagram are just for reference. For the exact locations, please see **Section 3.2.18** and **Section 3.2.19**.

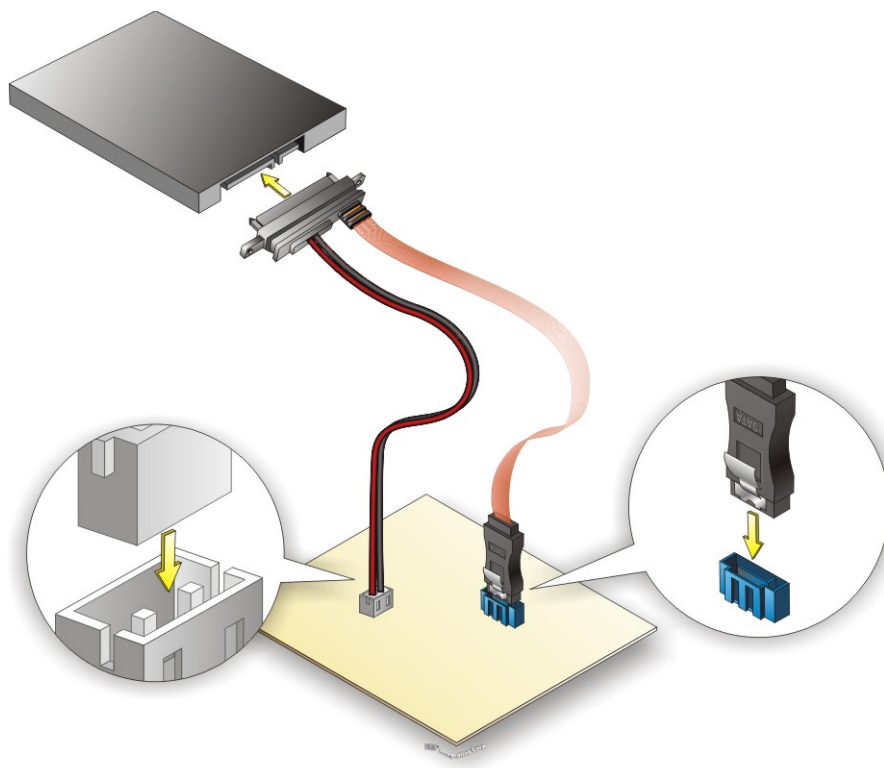

Figure 4-18: SATA Drive Cable Connection

Step 3: **Connect the cable to the SATA disk.** Connect the connector on the other end of the cable to the connector at the back of the SATA drive. See **Figure 4-18**.

Step 4: To remove the SATA cable from the SATA connector, press the clip on the connector at the end of the cable.

Chapter

5

BIOS

5.1 Introduction

The BIOS is programmed onto the BIOS chip. The BIOS setup program allows changes to certain system settings. This chapter outlines the options that can be changed.



NOTE:

Some of the BIOS options may vary throughout the life cycle of the product and are subject to change without prior notice.

5.1.1 Starting Setup

The UEFI BIOS is activated when the computer is turned on. The setup program can be activated in one of two ways.

1. Press the **DELETE** or **F2** key as soon as the system is turned on or
2. Press the **DELETE** or **F2** key when the “**Press Del to enter SETUP**” message appears on the screen.

If the message disappears before the **DELETE** or **F2** key is pressed, restart the computer and try again.

5.1.2 Using Setup

Use the arrow keys to highlight items, press **ENTER** to select, use the PageUp and PageDown keys to change entries, press **F1** for help and press **ESC** to quit. Navigation keys are shown in.

Key	Function
Up arrow	Move to previous item
Down arrow	Move to next item
Left arrow	Move to the item on the left hand side
Right arrow	Move to the item on the right hand side
+	Increase the numeric value or make changes

WAFER-BW SBC

Key	Function
-	Decrease the numeric value or make changes
F1 key	General help, only for Status Page Setup Menu and Option Page Setup Menu
F2 key	Load previous values.
F3 key	Load optimized defaults
F4 key	Save changes and Exit BIOS
Esc key	Main Menu – Quit and not save changes into CMOS Status Page Setup Menu and Option Page Setup Menu -- Exit current page and return to Main Menu

Table 5-1: BIOS Navigation Keys

5.1.3 Getting Help

When **F1** is pressed a small help window describing the appropriate keys to use and the possible selections for the highlighted item appears. To exit the Help Window press **Esc** or the **F1** key again.

5.1.4 Unable to Reboot after Configuration Changes

If the computer cannot boot after changes to the system configuration is made, CMOS defaults. Use the jumper described in **Section 4.6.2**.

5.1.5 BIOS Menu Bar

The **menu bar** on top of the BIOS screen has the following main items:

- Main – Changes the basic system configuration.
- Advanced – Changes the advanced system settings.
- Chipset – Changes the chipset settings.
- Security – Sets User and Supervisor Passwords.
- Boot – Changes the system boot configuration.
- Save & Exit – Selects exit options and loads default settings

The following sections completely describe the configuration options found in the menu items at the top of the BIOS screen and listed above.

5.2 Main

The **Main** BIOS menu (**BIOS Menu 1**) appears when the **BIOS Setup** program is entered. The **Main** menu gives an overview of the basic system information.

```

Aptio Setup Utility - Copyright (C) 2017 American Megatrends, Inc.
Main  Advanced  Chipset  Security  Boot  Save & Exit

BIOS Information
BIOS Vendor                American Megatrends
Core Version               5.11
Compliancy                 UEFI 2.4; PI 1.3
Project Version            B370AR15.BIN
Build Date and Time       04/25/2017 11:28:05

iWDD Vendor                iEi
iWDD Version               B370ER11.bin
Access Level               Administrator

CPU Configuration
Microcode Patch            40A

Memory Information
Total Memory               8192 MB(LPDDR3)

TXE Information
Sec RC Version             00.05.00.00
TXE FW Version             02.00.05.3107

System Date                [Fri 01/01/2010]
System Time                [00:18:35]

Set the Date. Use Tab to
switch between Data
elements.

-----
<->: Select Screen
^ v: Select Item
EnterSelect
+/-: Change Opt.
F1:  General Help
F2:  Previous Values
F3:  Optimized Defaults
F4:  Save & Exit
ESC: Exit

Version 2.18.1264. Copyright (C) 2017 American Megatrends, Inc.
  
```

BIOS Menu 1: Main

The Main menu lists the following system details:

- BIOS Information
- iWDD Information
- Memory Information
- TXE Information
- CPU Configuration

WAFFER-BW SBC

The System Overview field also has two user configurable fields:

→ **System Date [xx/xx/xx]**

Use the **System Date** option to set the system date. Manually enter the day, month and year.

→ **System Time [xx:xx:xx]**

Use the **System Time** option to set the system time. Manually enter the hours, minutes and seconds.

5.3 Advanced

Use the **Advanced** menu (**BIOS Menu 2**) to configure the CPU and peripheral devices through the following sub-menus:



WARNING!

Setting the wrong values in the sections below may cause the system to malfunction. Make sure that the settings made are compatible with the hardware.

```

Aptio Setup Utility - Copyright (C) 2017 American Megatrends, Inc.
Main  Advanced  Chipset  Security  Boot  Save & Exit
-----
> ACPI Settings
> RTC Wake Settings
> Serial Port Console Redirection
> F81866 Super IO Configuration
> iWDD H/W Monitor
> iEi Feature
> CPU Configuration
> SATA Configuration
> NVMe Configuration
> USB Configuration

System ACPI Parameters.
-----
<=>: Select Screen
↑ ↓: Select Item
Enter>Select
F1  General Help
F2  Previous Values
F3  Optimized Defaults
F4  Save
ESC Exit

Version 2.18.1264. Copyright (C) 2017 American Megatrends, Inc.
    
```

BIOS Menu 2: Advanced

5.3.1 ACPI Settings

The **ACPI Settings** menu (**BIOS Menu 3**) configures the Advanced Configuration and Power Interface (ACPI) options.

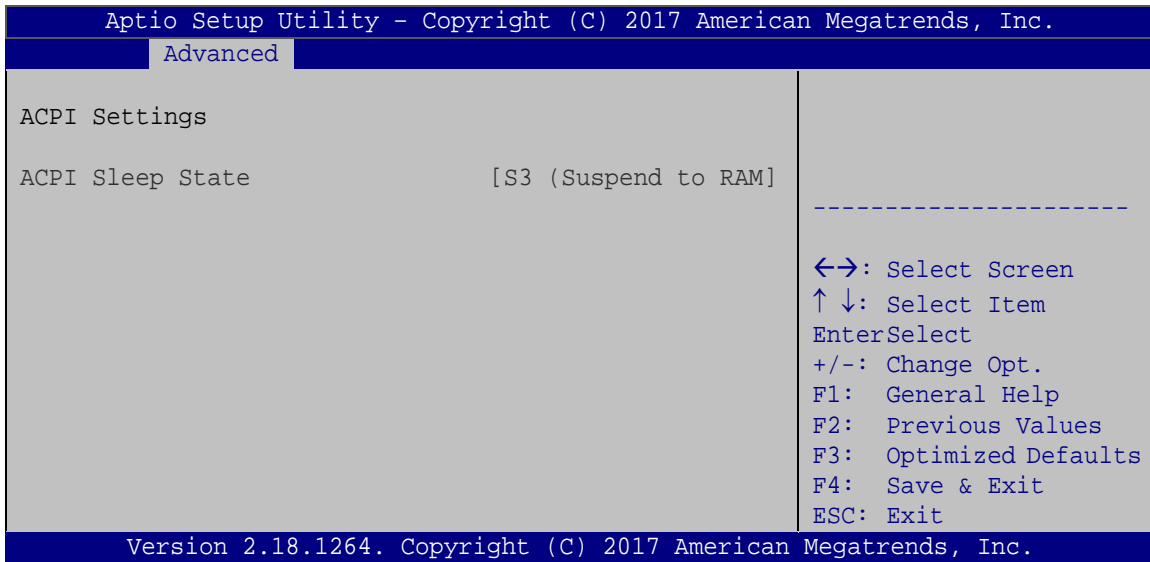

BIOS Menu 3: ACPI Settings

WAFER-BW SBC

5.3.2 RTC Wake Settings

The **RTC Wake Settings** menu (**BIOS Menu 4**) configures RTC wake event.

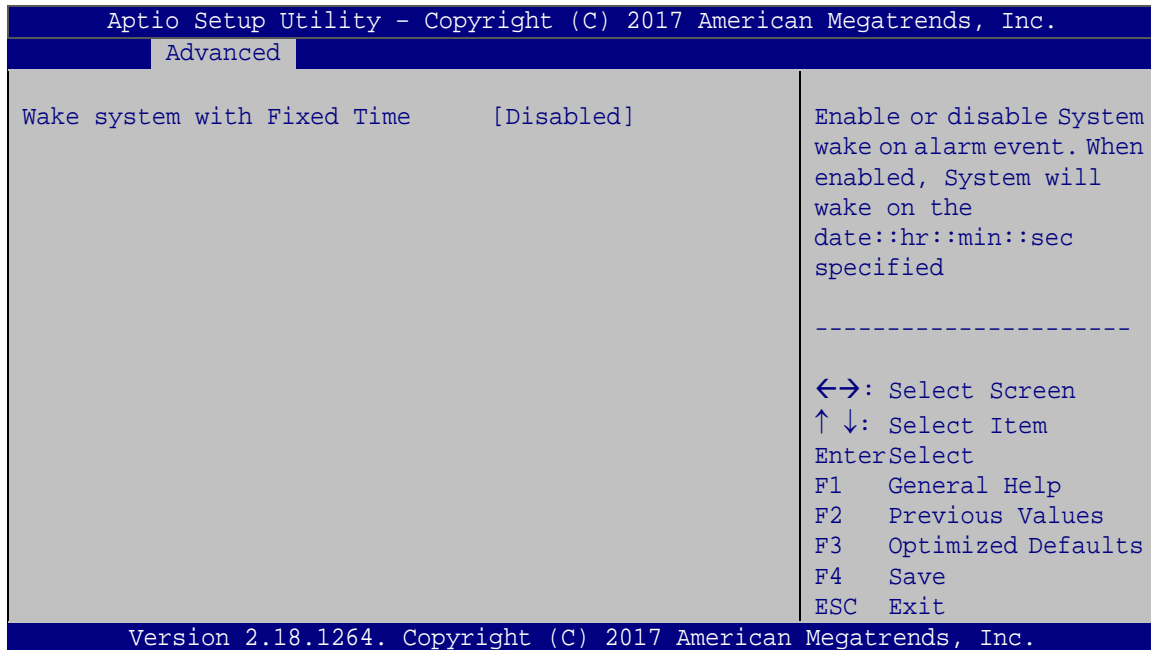

BIOS Menu 4: RTC Wake Settings

→ Wake system with Fixed Time [Disabled]

Use the **Wake system with Fixed Time** option to enable or disable the system wake on alarm event.

- **Disabled** **DEFAULT** The real time clock (RTC) cannot generate a wake event

- **Enabled** If selected, the **Wake up every day** option appears allowing you to enable to disable the system to wake every day at the specified time. Besides, the following options appear with values that can be selected:
 - Wake up date
 - Wake up hour
 - Wake up minute

Wake up second

After setting the alarm, the computer turns itself on from a suspend state when the alarm goes off.

5.3.3 Serial Port Console Redirection

The **Serial Port Console Redirection** menu (**BIOS Menu 5**) allows the console redirection options to be configured. Console redirection allows users to maintain a system remotely by re-directing keyboard input and text output through the serial port.

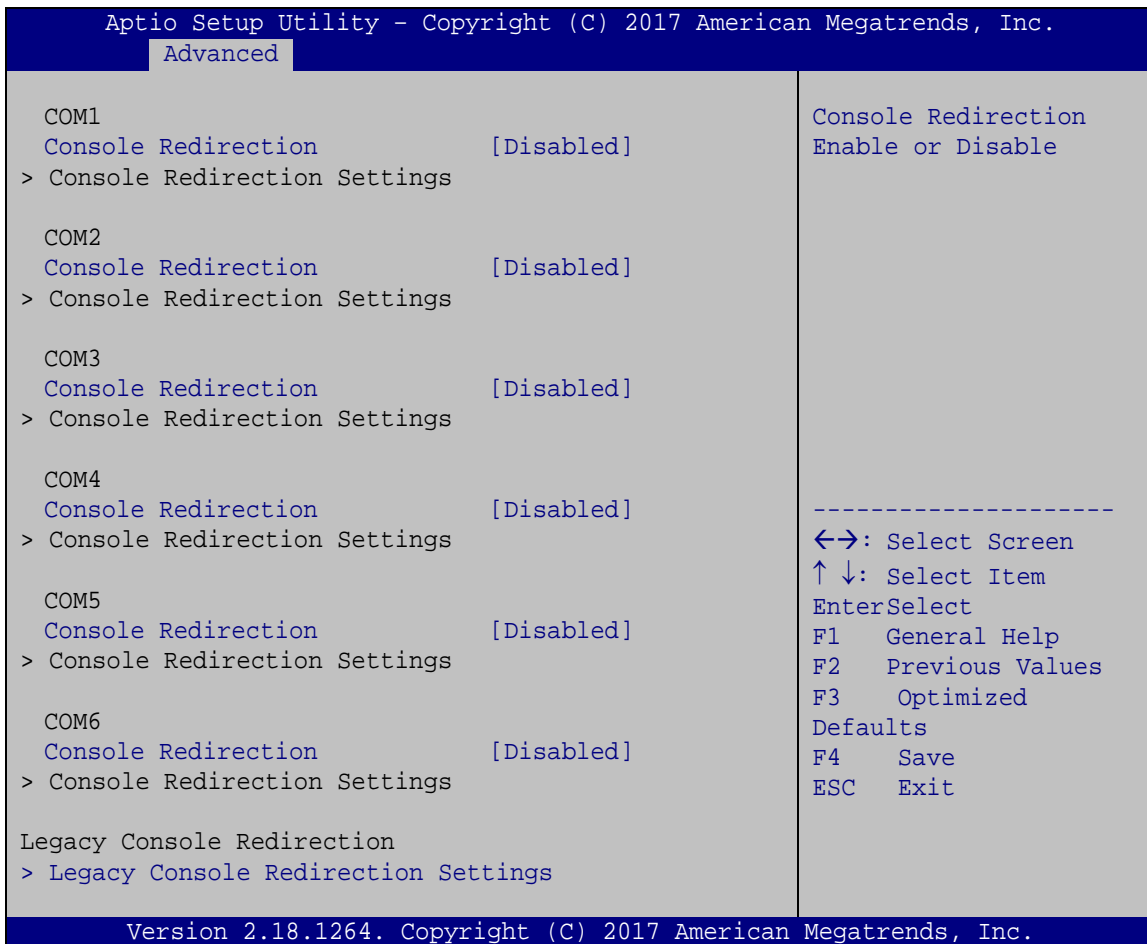

BIOS Menu 5: Serial Port Console Redirection

➔ Console Redirection [Disabled]

Use **Console Redirection** option to enable or disable the console redirection function.

WAFER-BW SBC

- ➔ **Disabled** **DEFAULT** Disabled the console redirection function
- ➔ **Enabled** Enabled the console redirection function

5.3.3.1 Legacy Console Redirection Settings

The **Legacy Console Redirection Settings** menu (**BIOS Menu 6**) allows the legacy console redirection options to be configured.

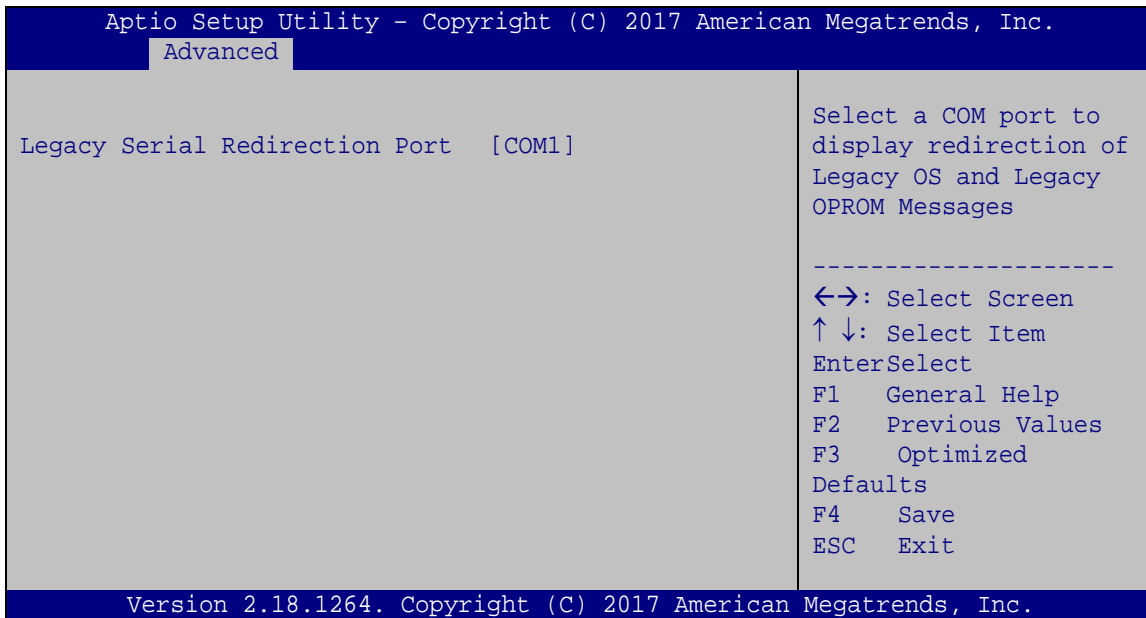

BIOS Menu 6: Legacy Console Redirection Settings

➔ Legacy Serial Redirection Port [COM1]

Use the **Legacy Serial Redirection Port** option to specify a COM port to display redirection of legacy OS and legacy OPROM messages. The options include:

- COM1 **DEFAULT**
- COM2
- COM3
- COM4
- COM5
- COM6

5.3.3.2 Console Redirection Settings

The **Console Redirection Settings** menu (**BIOS Menu 7**) allows the console redirection options to be configured. The option is active when Console Redirection option is enabled.

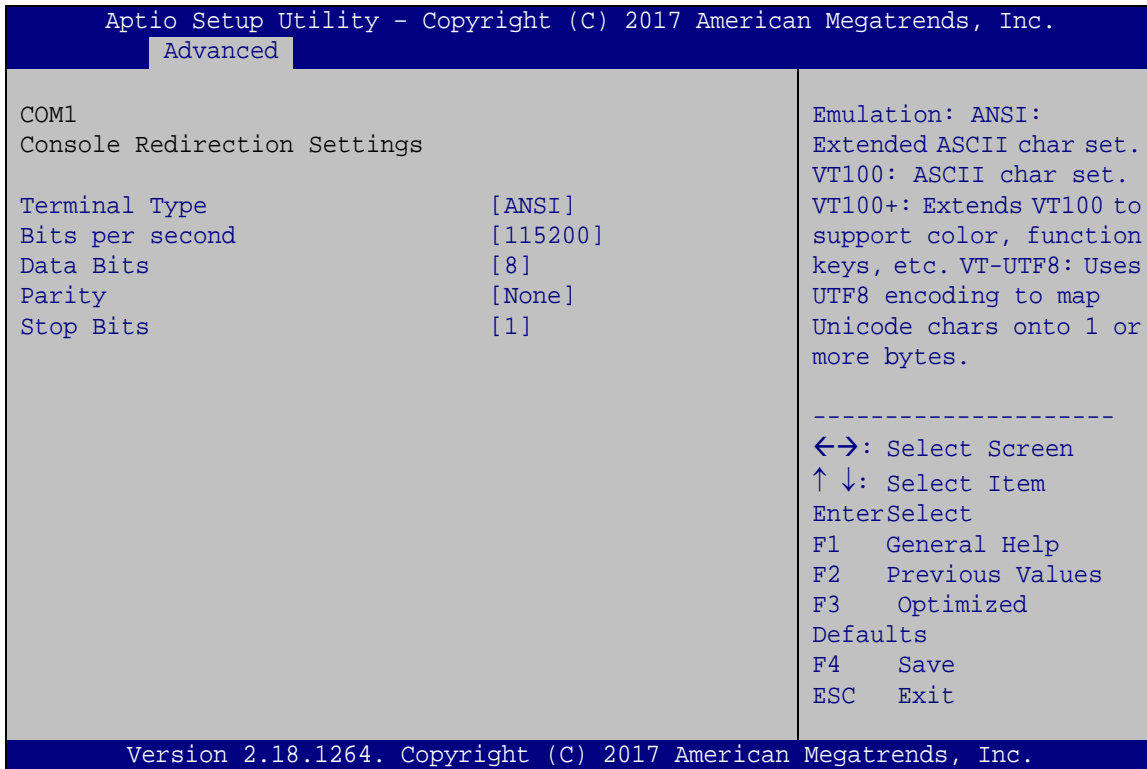

BIOS Menu 7: Console Redirection Settings

➔ Terminal Type [ANSI]

Use the **Terminal Type** option to specify the remote terminal type.

- ➔ **VT100** The target terminal type is VT100
- ➔ **VT100+** The target terminal type is VT100+
- ➔ **VT-UTF8** The target terminal type is VT-UTF8
- ➔ **ANSI** **DEFAULT** The target terminal type is ANSI

WAFER-BW SBC

→ Bits per second [115200]

Use the **Bits per second** option to specify the serial port transmission speed. The speed must match the other side. Long or noisy lines may require lower speeds.

- | | | | |
|---|---------------|----------------|--|
| → | 9600 | | Sets the serial port transmission speed at 9600. |
| → | 19200 | | Sets the serial port transmission speed at 19200. |
| → | 38400 | | Sets the serial port transmission speed at 38400. |
| → | 57600 | | Sets the serial port transmission speed at 57600. |
| → | 115200 | DEFAULT | Sets the serial port transmission speed at 115200. |

→ Data Bits [8]

Use the **Data Bits** option to specify the number of data bits.

- | | | | |
|---|----------|----------------|--------------------------|
| → | 7 | | Sets the data bits at 7. |
| → | 8 | DEFAULT | Sets the data bits at 8. |

→ Parity [None]

Use the **Parity** option to specify the parity bit that can be sent with the data bits for detecting the transmission errors.

- | | | | |
|---|--------------|----------------|---|
| → | None | DEFAULT | No parity bit is sent with the data bits. |
| → | Even | | The parity bit is 0 if the number of ones in the data bits is even. |
| → | Odd | | The parity bit is 0 if the number of ones in the data bits is odd. |
| → | Mark | | The parity bit is always 1. This option does not provide error detection. |
| → | Space | | The parity bit is always 0. This option does not provide error detection. |

→ Stop Bits [1]

Use the **Stop Bits** option to specify the number of stop bits used to indicate the end of a serial data packet. Communication with slow devices may require more than 1 stop bit.

- 1 **DEFAULT** Sets the number of stop bits at 1.
- 2 Sets the number of stop bits at 2.

5.3.4 F81866 Super IO Configuration

Use the **F81866 Super IO Configuration** menu (**BIOS Menu 8**) to set or change the configurations for the serial ports.

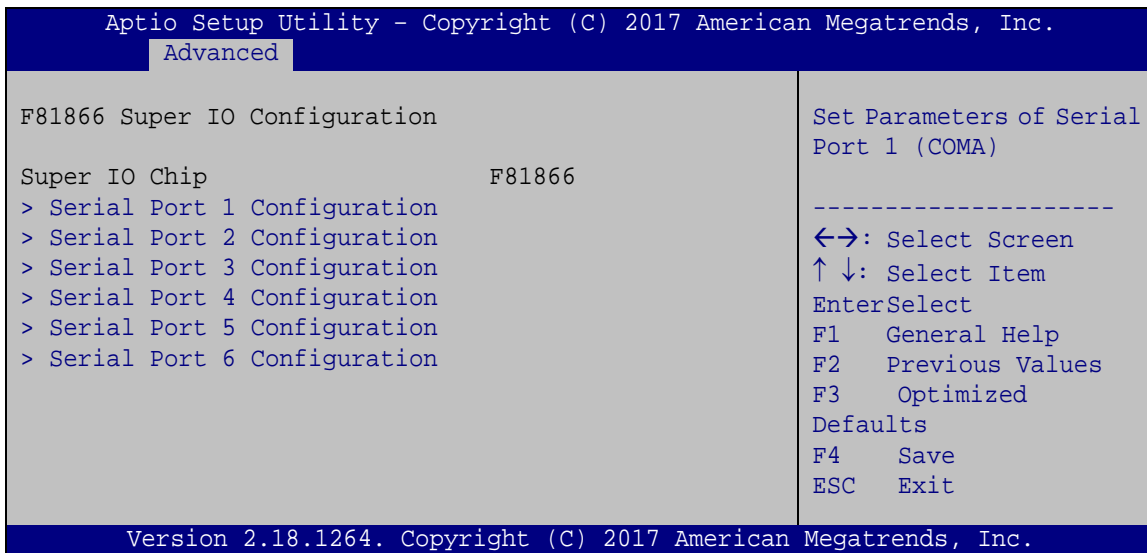

BIOS Menu 8: F81866 Super IO Configuration

WAFER-BW SBC

5.3.4.1 Serial Port n Configuration

Use the **Serial Port n Configuration** menu (**BIOS Menu 9**) to configure the serial port n.

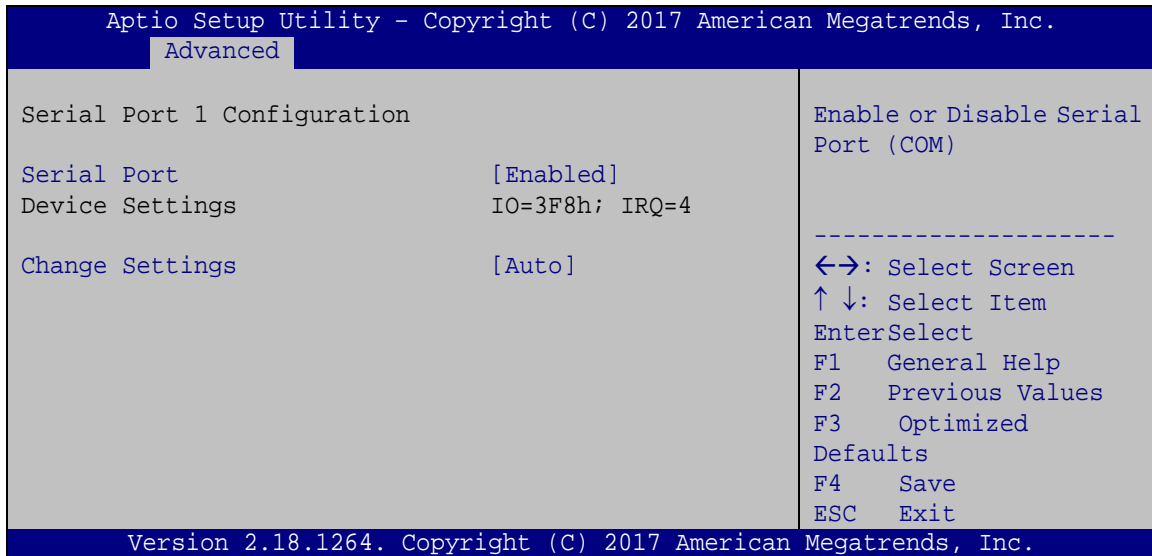

BIOS Menu 9: Serial Port n Configuration

5.3.4.1.1 Serial Port 1 Configuration

→ Serial Port [Enabled]

Use the **Serial Port** option to enable or disable the serial port.

- **Disabled** Disable the serial port
- **Enabled** **DEFAULT** Enable the serial port

→ Change Settings [Auto]

Use the **Change Settings** option to change the serial port IO port address and interrupt address.

- **Auto** **DEFAULT** The serial port IO port address and interrupt address are automatically detected.
- **IO=3F8h; IRQ=4** Serial Port I/O port address is 3F8h and the interrupt address is IRQ4

- ➔ **IO=3F8h; IRQ=3, 4,5,6,7,9,10,11,12** Serial Port I/O port address is 3F8h and the interrupt address is IRQ3,4,5,6,7,9,10,11,12
- ➔ **IO=2F8h; IRQ=3, 4,5,6,7,9,10,11,12** Serial Port I/O port address is 2F8h and the interrupt address is IRQ3,4,5,6,7,9,10,11,12
- ➔ **IO=3E8h; IRQ=3, 4,5,6,7,9,10,11,12** Serial Port I/O port address is 3E8h and the interrupt address is IRQ3,4,5,6,7,9,10,11,12
- ➔ **IO=2E8h; IRQ=3, 4,5,6,7,9,10,11,12** Serial Port I/O port address is 2E8h and the interrupt address is IRQ3,4,5,6,7,9,10,11,12

5.3.4.1.2 Serial Port 2 Configuration

➔ Serial Port [Enabled]

Use the **Serial Port** option to enable or disable the serial port.

- ➔ **Disabled** Disable the serial port
- ➔ **Enabled DEFAULT** Enable the serial port

➔ Change Settings [Auto]

Use the **Change Settings** option to change the serial port IO port address and interrupt address.

- ➔ **Auto DEFAULT** The serial port IO port address and interrupt address are automatically detected.
- ➔ **IO=2F8h; IRQ=3** Serial Port I/O port address is 2F8h and the interrupt address is IRQ3
- ➔ **IO=3F8h; IRQ=3, 4,5,6,7,9,10,11,12** Serial Port I/O port address is 3F8h and the interrupt address is IRQ3,4,5,6,7,9,10,11,12
- ➔ **IO=2F8h; IRQ=3, 4,5,6,7,9,10,11,12** Serial Port I/O port address is 2F8h and the interrupt address is IRQ3,4,5,6,7,9,10,11,12
- ➔ **IO=3E8h; IRQ=3, 4,5,6,7,9,10,11,12** Serial Port I/O port address is 3E8h and the interrupt address is IRQ3,4,5,6,7,9,10,11,12

WAFER-BW SBC

- ➔ **IO=2E8h; IRQ=3, 4,5,6,7,9,10,11,12** Serial Port I/O port address is 2E8h and the interrupt address is IRQ3,4,5,6,7,9,10,11,12

5.3.4.1.3 Serial Port 3 Configuration

➔ Serial Port [Enabled]

Use the **Serial Port** option to enable or disable the serial port.

- ➔ **Disabled** Disable the serial port
- ➔ **Enabled** **DEFAULT** Enable the serial port

➔ Change Settings [Auto]

Use the **Change Settings** option to change the serial port IO port address and interrupt address.

- ➔ **Auto** **DEFAULT** The serial port IO port address and interrupt address are automatically detected.
- ➔ **IO=3E8h; IRQ=10** Serial Port I/O port address is 3E8h and the interrupt address is IRQ10
- ➔ **IO=3E8h; IRQ=10,11** Serial Port I/O port address is 3E8h and the interrupt address is IRQ10,11
- ➔ **IO=2E8h; IRQ=10,11** Serial Port I/O port address is 2E8h and the interrupt address is IRQ10,11
- ➔ **IO=2D0h; IRQ=10,11** Serial Port I/O port address is 2D0h and the interrupt address is IRQ10,11
- ➔ **IO=2E0h; IRQ=10,11** Serial Port I/O port address is 2E0h and the interrupt address is IRQ10,11

5.3.4.1.4 Serial Port 4 Configuration

→ **Serial Port [Enabled]**

Use the **Serial Port** option to enable or disable the serial port.

- **Disabled** Disable the serial port
- **Enabled** **DEFAULT** Enable the serial port

→ **Change Settings [Auto]**

Use the **Change Settings** option to change the serial port IO port address and interrupt address.

- **Auto** **DEFAULT** The serial port IO port address and interrupt address are automatically detected.
- **IO=2E8h; IRQ=10** Serial Port I/O port address is 2E8h and the interrupt address is IRQ10
- **IO=3E8h;
IRQ=10,11** Serial Port I/O port address is 3E8h and the interrupt address is IRQ10,11
- **IO=2E8h;
IRQ=10,11** Serial Port I/O port address is 2E8h and the interrupt address is IRQ10,11
- **IO=2D0h;
IRQ=10,11** Serial Port I/O port address is 2D0h and the interrupt address is IRQ10,11
- **IO=2E0h;
IRQ=10,11** Serial Port I/O port address is 2E0h and the interrupt address is IRQ10,11

→ **Serial Port Mode [RS232]**

Use the **Serial Port Mode** option to select the Serial Port 4 signaling mode.

- **RS232** **DEFAULT** Serial Port 5 signaling mode is RS-232
- **RS422** Serial Port 5 signaling mode is RS-422
- **RS485** Serial Port 5 signaling mode is RS-485

5.3.4.1.5 Serial Port 5 Configuration

→ Serial Port [Enabled]

Use the **Serial Port** option to enable or disable the serial port.

- **Disabled** Disable the serial port
- **Enabled** **DEFAULT** Enable the serial port

→ Change Settings [Auto]

Use the **Change Settings** option to change the serial port IO port address and interrupt address.

- **Auto** **DEFAULT** The serial port IO port address and interrupt address are automatically detected.
- **IO=2D0h; IRQ=11** Serial Port I/O port address is 2D0h and the interrupt address is IRQ11
- **IO=3E8h;
IRQ=10,11** Serial Port I/O port address is 3E8h and the interrupt address is IRQ10,11
- **IO=2E8h;
IRQ=10,11** Serial Port I/O port address is 2E8h and the interrupt address is IRQ10,11
- **IO=2D0h;
IRQ=10,11** Serial Port I/O port address is 2D0h and the interrupt address is IRQ10,11
- **IO=2E0h;
IRQ=10,11** Serial Port I/O port address is 2E0h and the interrupt address is IRQ10,11

5.3.4.1.6 Serial Port 6 Configuration

→ **Serial Port [Enabled]**

Use the **Serial Port** option to enable or disable the serial port.

- **Disabled** Disable the serial port
- **Enabled** **DEFAULT** Enable the serial port

→ **Change Settings [Auto]**

Use the **Change Settings** option to change the serial port IO port address and interrupt address.

- **Auto** **DEFAULT** The serial port IO port address and interrupt address are automatically detected.
- **IO=2E0h; IRQ=11** Serial Port I/O port address is 2E0h and the interrupt address is IRQ11
- **IO=3E8h;
IRQ=10,11** Serial Port I/O port address is 3E8h and the interrupt address is IRQ10,11
- **IO=2E8h;
IRQ=10,11** Serial Port I/O port address is 2E8h and the interrupt address is IRQ10,11
- **IO=2D0h;
IRQ=10,11** Serial Port I/O port address is 2D0h and the interrupt address is IRQ10,11
- **IO=2E0h;
IRQ=10,11** Serial Port I/O port address is 2E0h and the interrupt address is IRQ10,11

→ **Serial Port Mode [RS232]**

Use the **Serial Port Mode** option to select the Serial Port 6 signaling mode.

- **RS232** **DEFAULT** Serial Port 6 signaling mode is RS-232
- **RS422** Serial Port 6 signaling mode is RS-422
- **RS485** Serial Port 6 signaling mode is RS-485

WAFER-BW SBC

5.3.5 iWDD H/W Monitor

The **iWDD H/W Monitor** menu (**BIOS Menu 10**) contains the fan configuration submenus and displays operating temperature, fan speeds and system voltages.

```

Aptio Setup Utility - Copyright (C) 2017 American Megatrends, Inc.
Advanced
PC Health Status
CPU temperature           :+45 °C
System temperature       :+38 °C
CPU_FAN1 Speed           :N/A
CPU_CORE                  :+1.217 V
+5V                       :+4.979 V
+12V                      :+12.319 V
+DDR                      :+1.366 V
+5VSB                     :+4.985 V
+3.3V                     :+3.282 V
+3.3VSB                   :+3.277 V
> Smart Fan Mode Configuration
Smart Fan Mode Select
-----
<->: Select Screen
↑ ↓: Select Item
EnterSelect
+ - Change Opt.
F1  General Help
F2  Previous Values
F3  Optimized Defaults
F4  Save & Exit
ESC Exit
Version 2.18.1264. Copyright (C) 2017 American Megatrends, Inc.
    
```

BIOS Menu 10: iWDD H/W Monitor

➔ PC Health Status

The following system parameters and values are shown. The system parameters that are monitored are:

- System Temperatures:
 - CPU Temperature
 - System temperature
- Fan Speed:
 - CPU Fan Speed
- Voltages
 - CPU_CORE
 - +5V
 - +12V
 - +DDR
 - +5VSB

WAFER-BW SBC

→ Auto mode fan start temperature [50]



WARNING:

Setting this value too high may cause the fan to rotate at full speed only when the CPU is at a very high temperature and therefore cause the system to be damaged.

The **Auto mode fan start temperature** option can only be set if the **CPU_FAN1 Smart Fan Control** option is set to **Auto Mode**. If the system temperature is between **Start Temperature** and **Off Temperature**, the fan speed change to be **Start PWM**. To set a value, select the **Auto mode fan start temperature** option and enter a decimal number between 1 and 100. The temperature range is specified below.

- Minimum Value: 1°C
- Maximum Value: 100°C

→ Auto mode fan off temperature [40]



WARNING:

Setting this value too high may cause the fan to speed up only when the CPU is at a very high temperature and therefore cause the system to be damaged.

The **Auto mode fan off temperature** option can only be set if the **CPU_FAN1 Smart Fan control** option is set to **Auto Mode**. If the system temperature is lower than **Auto mode fan off temperature**, the fan speed change to be lowest. To set a value, select the **Auto mode fan off temperature** option and enter a decimal number between 1 and 100. The temperature range is specified below.

- Minimum Value: 1°C
- Maximum Value: 100°C

→ **Auto mode fan start PWM [30]**

The **Auto mode fan start PWM** option can only be set if the **CPU_FAN1 Smart Fan control** option is set to **Auto Mode**. Use the **Auto mode fan start PWM** option to set the PWM start value. To set a value, select the **Auto mode fan start PWM** option and enter a decimal number between 1 and 100. The temperature range is specified below.

- Minimum Value: 1
- Maximum Value: 100

→ **Auto mode fan slope PWM [2]**

The **Auto mode fan slope PWM** option can only be set if the **CPU_FAN1 Smart Fan control** option is set to **Auto Mode**. Use the **Auto mode fan slope PWM** option to select the linear rate at which the PWM mode increases with respect to an increase in temperature. To set a value, select the **Auto mode fan slope PWM** option and enter a decimal number between 1 and 8.

5.3.7 CPU Configuration

Use the **CPU Configuration** menu (**BIOS Menu 13**) to view detailed CPU specifications and configure the CPU.

```

Aptio Setup Utility - Copyright (C) 2017 American Megatrends, Inc.
  Advanced
CPU Configuration
Intel(R) Celeron(R) CPU N3060 @ 1.60GHz
CPU Signature          406C4
Microcode Patch       408
Max CPU Speed         1600 MHz
Min CPU Speed         480 MHz
Processor Cores       2
Intel HT Technology   Not Supported
Intel VT-x Technology Supported

L1 Data Cache        24 KB x 2
L1 Code Cache        32 KB x 2
L2 Cache             1024 KB x 2
L3 Cache             Not Present
64-bit               Supported

Intel Virtualization Technology [Enabled]
EIST                  [Enabled]
CPU C State Report   [Disabled]

When enabled, a VMM can utilize the additional hardware capabilities provided by Vanderpool Technology.

-----
<->: Select Screen
^ v: Select Item
EnterSelect
F1  General Help
F2  Previous Values
F3  Optimized
Defaults
F4  Save
ESC Exit

Version 2.18.1264. Copyright (C) 2017 American Megatrends, Inc.
  
```

BIOS Menu 13: CPU Configuration

➔ Intel® Virtualization Technology [Enabled]

Use the **Intel® Virtualization Technology** option to enable or disable virtualization on the system. When combined with third party software, Intel® Virtualization technology allows several OSs to run on the same system at the same time.

- ➔ **Disabled** Disables Intel® Virtualization Technology.
- ➔ **Enabled** **DEFAULT** Enables Intel® Virtualization Technology.

WAFER-BW SBC

→ EIST [Enabled]

Use the **EIST** option to enable or disable the Intel® Speed Step Technology.

→ **Disabled** Disables the Intel® Speed Step Technology.

→ **Enabled** **DEFAULT** Enables the Intel® Speed Step Technology.

→ CPU C State Report [Disabled]

Use the **CPU C State Report** option to enable or disable CPU C state report to OS.

→ **Disabled** **DEFAULT** Disables CPU C state report to OS.

→ **Enabled** Enables CPU C state report to OS.

5.3.8 SATA Configuration

Use the **SATA Configuration** menu (**BIOS Menu 14**) to change and/or set the configuration of the SATA devices installed in the system.

```

Aptio Setup Utility - Copyright (C) 2017 American Megatrends, Inc.
  Advanced
SATA Configuration                                Enable/Disable SATA
                                                Device
STAT Controller                                [Enabled]
SATA Mode Selection                            [AHCI]
-----
SATA1 Port
Not Present
Hot Plug                                        [Disabled]
SATA2 Port (MSATA)
Not Present
Hot Plug                                        [Disabled]
<->: Select Screen
↑ ↓: Select Item
Enter>Select
F1  General Help
F2  Previous Values
F3  Optimized
Defaults
F4  Save
ESC Exit
Version 2.18.1264. Copyright (C) 2017 American Megatrends, Inc.
    
```

BIOS Menu 14: SATA Configuration

→ **STAT Configuration [Enabled]**

Use the **STAT Configuration** option to enable or disable the SATA device.

- **Enabled** **DEFAULT** Enables the SATA device.
- **Disabled** Disables the SATA device.

→ **SATA Mode Selection [AHCI]**

Use the **SATA Mode Selection** option to configure SATA devices as AHCI devices.

- **AHCI** **DEFAULT** Configures SATA devices as AHCI device.

→ **Hot Plug [Disabled]**

Use the **Hot Plug** option to enable or disable the SATA device hot plug.

- **Enabled** Enables the SATA device hot plug
- **Disabled** **DEFAULT** Disables the SATA device hot plug.

WAFER-BW SBC

5.3.9 NVMe Configuration

Use the **NVMe Configuration** menu (**BIOS Menu 15**) to change and/or set the configuration of the NVMe devices installed in the system.

```
Aptio Setup Utility - Copyright (C) 2017 American Megatrends, Inc.
  Advanced
NVMe Controller and Drive information
No NVME Device Found
-----
<->: Select Screen
↑ ↓: Select Item
EnterSelect
F1   General Help
F2   Previous Values
F3   Optimized
Defaults
F4   Save
ESC  Exit
Version 2.18.1264. Copyright (C) 2017 American Megatrends, Inc.
```

BIOS Menu 15: NVMe Configuration

5.3.10 USB Configuration

Use the **USB Configuration** menu (**BIOS Menu 16**) to read USB configuration information and configure the USB settings.



BIOS Menu 16: USB Configuration

→ USB Devices

The **USB Devices Enabled** field lists the USB devices that are enabled on the system

→ Legacy USB Support [Enabled]

Use the **Legacy USB Support** BIOS option to enable USB mouse and USB keyboard support. Normally if this option is not enabled, any attached USB mouse or USB keyboard does not become available until a USB compatible operating system is fully booted with all USB drivers loaded. When this option is enabled, any attached USB mouse or USB keyboard can control the system even when there is no USB driver loaded onto the system.

→ **Enabled** **DEFAULT** Legacy USB support enabled

WAFER-BW SBC

- ➔ **Disabled** Legacy USB support disabled
- ➔ **Auto** Legacy USB support disabled if no USB devices are connected

5.4 Chipset

Use the **Chipset** menu (**BIOS Menu 17**) to access the north bridge and south bridge configuration menus



WARNING!

Setting the wrong values for the Chipset BIOS selections in the Chipset BIOS menu may cause the system to malfunction.

```

Aptio Setup Utility - Copyright (C) 2017 American Megatrends, Inc.
Main   Advanced  Chipset  Security  Boot   Save & Exit
-----
> North Bridge
> South Bridge

North Bridge Parameters
-----
<->: Select Screen
↑ ↓: Select Item
Enter>Select
+/-: Change Opt.
F1   General Help
F2   Previous Values
F3   Optimized Defaults
F4   Save & Exit
ESC  Exit

Version 2.18.1264. Copyright (C) 2017 American Megatrends, Inc.
    
```

BIOS Menu 17: Chipset

5.4.1 North Bridge Configuration

Use the **North Bridge Configuration** menu (**BIOS Menu 18**) to configure the Intel IGD settings.

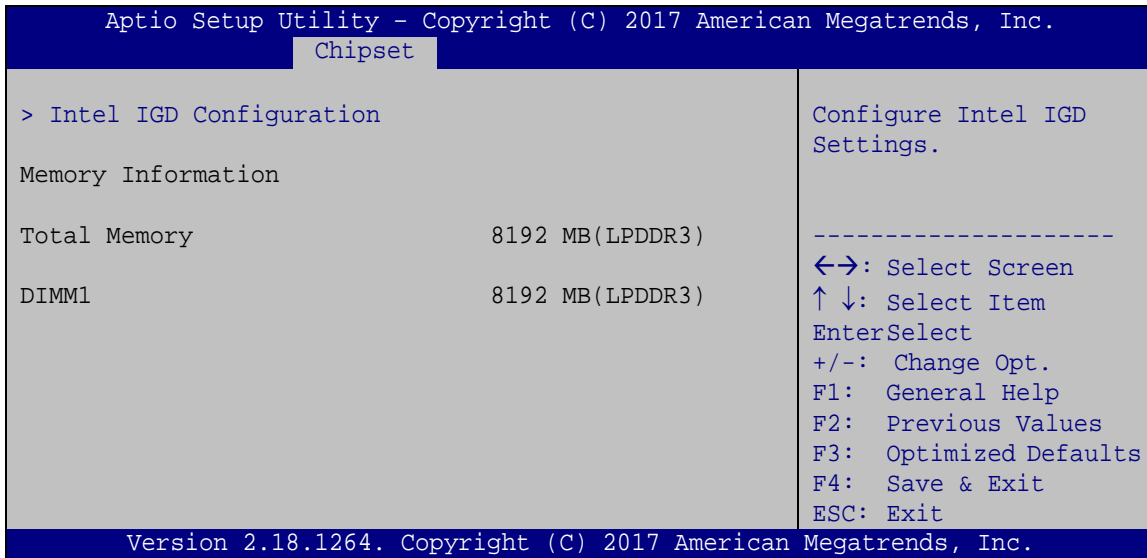

BIOS Menu 18: North Bridge Configuration

→ Memory Information

The **Memory Information** lists a brief summary of the on-board memory. The fields in **Memory Information** cannot be changed.

WAFER-BW SBC

5.4.1.1 Intel IGD Configuration

Use the **Intel IGD Configuration** menu (**BIOS Menu 19**) to configure the video device connected to the system.

```

Aptio Setup Utility - Copyright (C) 2017 American Megatrends, Inc.
Chipset
-----
Intel IGD Configuration
Integrated Graphics Device      [Enabled]
Primary Display                 [Auto]
DVMT Pre-Allocated             [256M]
DVMT Total Gfx Mem             [Max]

On board LVDS                  [Enabled]
Backlight Control Mode         [CCFL]
LCD Panel Type                 [800x600 18bit]
Backlight Control Voltage Level [3.3V]

-----
<=>: Select Screen
↑ ↓: Select Item
Enter>Select
+/-: Change Opt.
F1:  General Help
F2:  Previous Values
F3:  Optimized Defaults
F4:  Save & Exit
ESC: Exit

Version 2.18.1264. Copyright (C) 2017 American Megatrends, Inc.
  
```

BIOS Menu 19: Intel IGD Configuration

→ Integrated Graphics Device [Enabled]

Use the **Integrated Graphics Device** option enables or disables Integrated Graphics Device (IGD).

- **Enabled** **DEFAULT** Enabled Integrated Graphics Device (IGD) when selected as the Primary Video Adaptor.
- **Disabled** Always disable IGD.

→ Primary Display [Auto]

Use the **Primary Display** option to select the graphics controller used as the primary boot device. Select either an integrated graphics controller (IGD) or a PCI express (PEG) controller. Configuration options are listed below:

- Auto **DEFAULT**
- IGD
- PCIe

→ DVMT Pre-Allocated [256MB]

Use the **DVMT Pre-Allocated** option to set the amount of system memory allocated to the integrated graphics processor when the system boots. The system memory allocated can then only be used as graphics memory, and is no longer available to applications or the operating system. Configuration options are listed below:

- 64M
- 128M
- 256M **DEFAULT**
- 512M

→ DVMT Total Gfx Mem [Max]

Use the **DVMT Total Gfx Mem** option to select DVMT5.0 total graphic memory size used by the internal graphic device. The following options are available:

- 128M
- 256M
- Max **DEFAULT**

→ On board LVDS [Enabled]

Use the **On board LVDS** option enables or disables the on-board LVDS connector.

- Disabled** The on-board LVDS connector is disabled.
- Enabled DEFAULT** The on-board LVDS connector is enabled.

WAFER-BW SBC

→ Backlight Control Mode [CCFL]

Use the **Backlight Control Mode** option to specify the backlight control mode. Configuration options are listed below.

- LED
- CCFL **DEFAULT**

→ LCD Panel Type [800x600 18bit]

Use the **LCD Panel Type** option to select the type of flat panel connected to the system. Configuration options are listed below.

- 800x600 18bit **DEFAULT**
- 1024x768 18bit
- 1024x768 24bit
- 1280x768 18bit
- 1280x800 18bit
- 1280x960 18bit
- 1280x1024 48bit
- 1366x768 18bit
- 1366x768 24bit
- 1440x900 48bit
- 1400x1050 48bit
- 1600x900 48bit
- 1680x1050 48bit
- 1600x1200 48bit
- 1920x1080 48bit
- 1920x1200 48bit

→ Backlight Control Voltage Level [3.3V]

Use the **Backlight Control Voltage Level** option to specify the voltage of the power supplied to the LCD panel. Configuration options are listed below.

- 3.3V **DEFAULT**
- 5.0V

5.4.2 South Bridge Configuration

Use the **South Bridge Configuration** menu (**BIOS Menu 20**) to configure the south bridge chipset.

```

Aptio Setup Utility - Copyright (C) 2017 American Megatrends, Inc.
Chipset
Auto Power Button Status      [Disable (ATX)]      Select AC power state
                             when power is re-applied
Restore AC Power Loss         [Last State]         after a power failure.
Audio Controller              [Enabled]
> PCI Express Configuration
-----
<->: Select Screen
↑ ↓: Select Item
EnterSelect
+/-: Change Opt.
F1: General Help
F2: Previous Values
F3: Optimized Defaults
F4: Save & Exit
ESC: Exit
Version 2.18.1264. Copyright (C) 2017 American Megatrends, Inc.
    
```

BIOS Menu 20: South Bridge Configuration

→ Restore on AC Power Loss [Last State]

Use the **Restore on AC Power Loss** BIOS option to specify what state the system returns to if there is a sudden loss of power to the system.

- **Power Off** The system remains turned off
- **Power On** The system turns on
- **Last State** **DEFAULT** The system returns to its previous state. If it was on, it turns itself on. If it was off, it remains off.

WAFER-BW SBC

→ Audio Controller [Enabled]

Use the **Audio Controller** option to enable or disable the High Definition Audio controller.

- **Disabled** The onboard High Definition Audio controller is disabled
- **Enabled DEFAULT** The onboard High Definition Audio controller is detected automatically and enabled

5.4.2.1 PCI Express Configuration

Use the **PCI Express Configuration** menu (**BIOS Menu 21**) to configure the PCI Express.

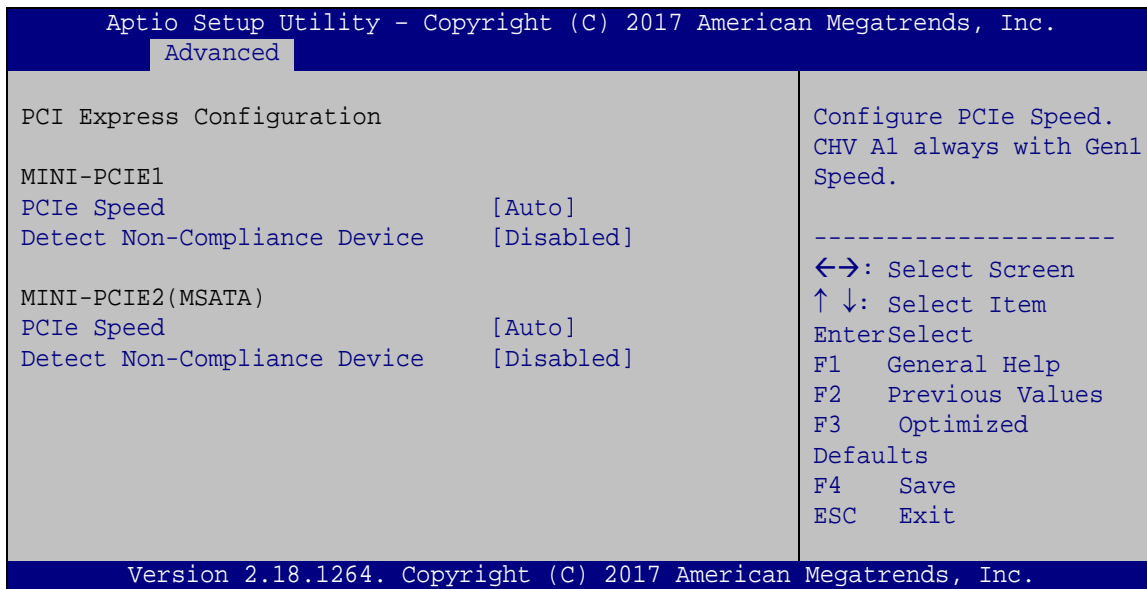

BIOS Menu 21: PCI Express Configuration

→ PCIe Speed [Auto]

Use the **PCIe Speed** option to configure PCIe port speed.

- **Auto DEFAULT** Configure PCIe port speed to auto
- **Gen 2** Configure PCIe port speed to Gen2
- **Gen 1** Configure PCIe port speed to Gen1

➔ **Detect Non-Compliance Device [Disabled]**

Use the **Detect Non-Compliance Device** option to enable or disable the Non-compliant PCIe device detection function.

- ➔ **Disabled** **DEFAULT** Disables non-compliant PCIe device detection.
- ➔ **Enabled** Enables non-compliant PCIe device detection.

5.5 Security

Use the **Security** menu (**BIOS Menu 22**) to set system and user passwords.

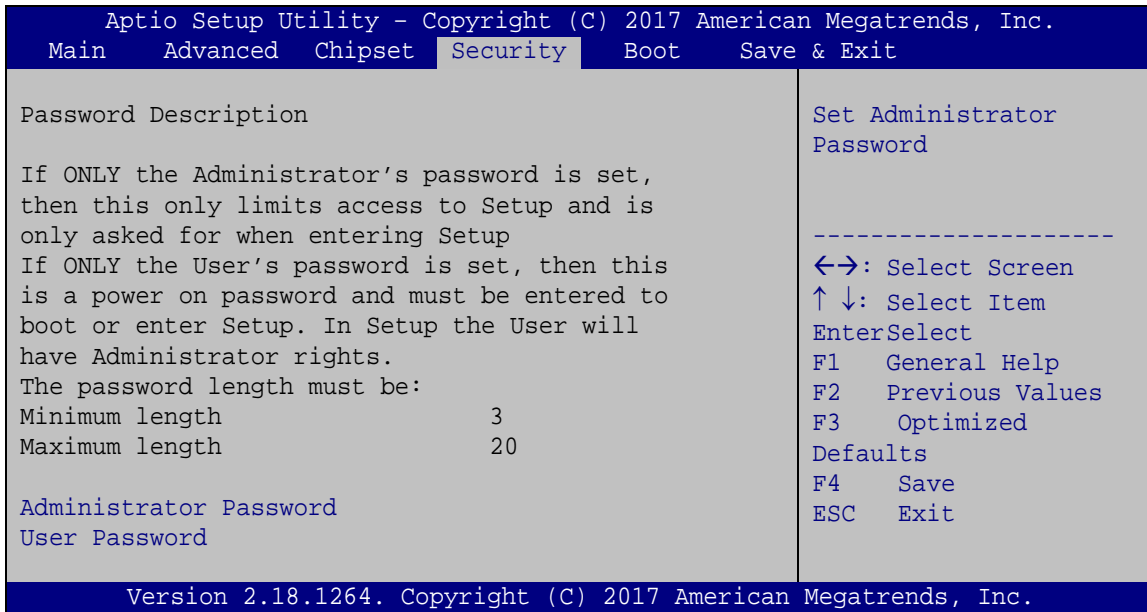

BIOS Menu 22: Security

➔ **Administrator Password**

Use the **Administrator Password** to set or change a administrator password.

➔ **User Password**

Use the **User Password** to set or change a user password.

WAFER-BW SBC

5.6 Boot

Use the **Boot** menu (**BIOS Menu 23**) to configure system boot options.

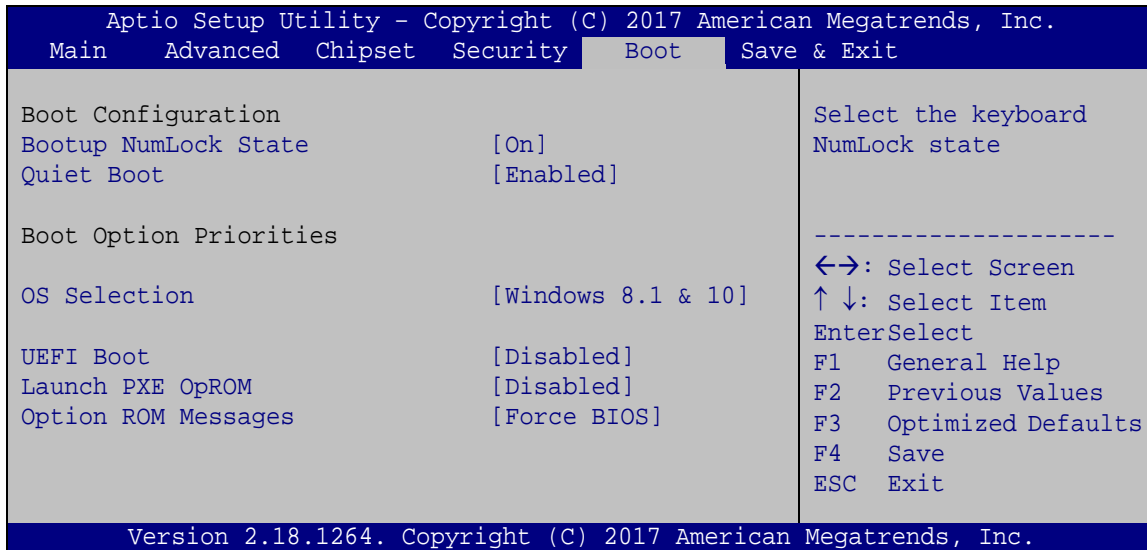

BIOS Menu 23: Boot

→ Bootup NumLock State [On]

Use the **Bootup NumLock State** BIOS option to specify if the number lock setting must be modified during boot up.

- **On** **DEFAULT** Allows the Number Lock on the keyboard to be enabled automatically when the computer system boots up. This allows the immediate use of the 10-key numeric keypad located on the right side of the keyboard. To confirm this, the Number Lock LED light on the keyboard is lit.
- **Off** Does not enable the keyboard Number Lock automatically. To use the 10-keys on the keyboard, press the Number Lock key located on the upper left-hand corner of the 10-key pad. The Number Lock LED on the keyboard lights up when the Number Lock is engaged.

→ Quiet Boot [Enabled]

Use the **Quiet Boot** BIOS option to select the screen display when the system boots.

- **Disabled** Normal POST messages displayed
- **Enabled** **DEFAULT** OEM Logo displayed instead of POST messages

→ OS Selection [Windows 8.1 & 10]

Use the **OS Selection** BIOS option to select an operating system (OS) before installing OS.

- **Windows 8.1 & 10** **DEFAULT** The system will be installed with Windows 8.1 or Windows 10 operating system.
- **Windows 7** The system will be installed with Windows 7 operating system.
- **Linux** The system will be installed with Linux operating system.

→ UEFI Boot [Disabled]

Use the **UEFI Boot** option to enable or disable to boot from the UEFI devices.

- **Enabled** Boot from UEFI devices is enabled.
- **Disabled** **DEFAULT** Boot from UEFI devices is disabled.

→ Launch PXE OpROM [Disabled]

Use the **Launch PXE OpROM** option to enable or disable boot option for legacy network devices.

- **Disabled** **DEFAULT** Ignore all PXE Option ROMs
- **Enabled** Load PXE Option ROMs.

WAFER-BW SBC

→ Option ROM Messages [Force BIOS]

Use the **Option ROM Messages** option to set the Option ROM display mode.

- **Force BIOS** **DEFAULT** Sets display mode to force BIOS.
- **Keep Current** Sets display mode to current.

→ Boot Option Priority

Use the **Boot Option Priority** function to set the system boot sequence from the available devices. The drive sequence also depends on the boot sequence in the individual device section.

5.7 Exit

Use the **Exit** menu (**BIOS Menu 24**) to load default BIOS values, optimal failsafe values and to save configuration changes.

```

Aptio Setup Utility - Copyright (C) 2017 American Megatrends, Inc.
Main  Advanced  Chipset  Security  Boot  Save & Exit
-----
Save Options
Save Changes and Reset
Discard Changes and Reset

Default Options
Restore Defaults
Save as User Defaults
Restore User Defaults

Reset the system after
saving the changes.

-----
<->: Select Screen
↑ ↓: Select Item
Enter>Select
F1  General Help
F2  Previous Values
F3  Optimized
Defaults
F4  Save
ESC Exit

Version 2.18.1264. Copyright (C) 2017 American Megatrends, Inc.
  
```

BIOS Menu 24: Exit

→ **Save Changes and Reset**

Use the **Save Changes and Reset** option to save the changes made to the BIOS options and to exit the BIOS configuration setup program.

→ **Discard Changes and Reset**

Use the **Discard Changes and Reset** option to exit the system without saving the changes made to the BIOS configuration setup program.

→ **Restore Defaults**

Use the **Restore Defaults** option to load the optimal default values for each of the parameters on the Setup menus. **F3 key can be used for this operation.**

→ **Save as User Defaults**

Use the **Save as User Defaults** option to save the changes done so far as user defaults.

→ **Restore User Defaults**

Use the **Restore User Defaults** option to restore the user defaults to all the setup options.

Chapter

6

Software Drivers

6.1 Available Drivers

All the drivers for the WAFER-BW are available on IEI Resource Download Center (<https://download.ieiworld.com>). Type WAFER-BW and press Enter to find all the relevant software, utilities, and documentation.

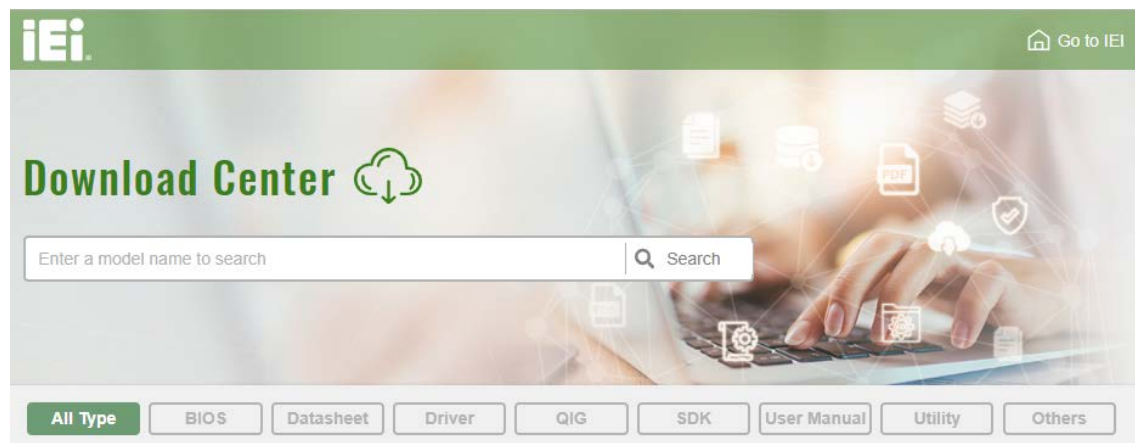
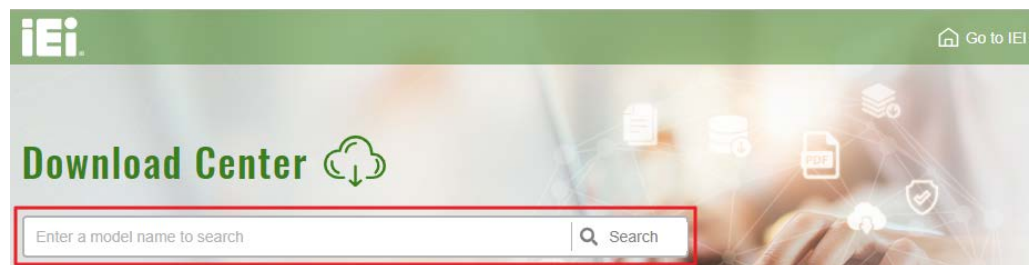

Figure 6-1: IEI Resource Download Center

6.2 Driver Download

To download drivers from IEI Resource Download Center, follow the steps below.

Step 1: Go to <https://download.ieiworld.com>. Type WAFER-BW and press Enter.



Step 2: All product-related software, utilities, and documentation will be listed. You can choose **Driver** to filter the result.

WAFER-BW SBC

[All Type](#)
[BIOS](#)
[Datasheet](#)
[Driver](#)
[QIG](#)
[SDK](#)
[User Manual](#)
[Utility](#)
[Others](#)

WAFER-BT-i1 [Product Info](#)

[Embedded Computer](#) ▶ [Single Board Computer](#) ▶ [Embedded Board](#)
 3.5" SBC with Intel® 22nm Atom™/Celeron® on-board SoC

Driver

File Name	Published	Version	File Checksum
7B000-001033-RS V2.3.iso (2.23 GB)	2017/10/03	2.30	3B2DB1F792779A93A8F50DDBC3943E30

Step 3: Click the driver file name on the page and you will be prompted with the following window. You can download the entire ISO file (❶), or click the small arrow to find an individual driver and click the file name to download (❷).

7B000-001168-RS_V1.4.iso

❶ [Click here to download entire ISO file. \(2.99 GB\)](#)

* Download individual file *

- Docs
 - 1.Chipset
 - ❷ 10.1.1.12.zip (2.7 MB)
 - 2.VGA
 - 3.Audio
 - 4.Lan
 - 5.USB 3.0
 - 6.Serial IO
 - 7.TXE
 - 8.Manual



NOTE:

To install software from the downloaded ISO image file in Windows 8, 8.1 or 10, double-click the ISO file to mount it as a virtual drive to view its content. On Windows 7 system, an additional tool (such as Virtual CD-ROM Control Panel from Microsoft) is needed to mount the file.

**NOTE:**

The Intel TXE requires that Microsoft's "Kernel-Mode Driver Framework (KMDf) version 1.11 update for Windows 7" must be installed first on Windows 7 OS. If the KMDf is not installed, either error 37 or error 28 may appear on the Intel TXE device in Device Manager.

Please find the KMDf version 1.11 update for Windows 7 in the TXE driver folder or click the following link to download it.

<http://www.microsoft.com/en-us/download/details.aspx?id=38423>

Appendix

A

Regulatory Compliance

DECLARATION OF CONFORMITY

This equipment has been tested and found to comply with specifications for CE marking. If the user modifies and/or installs other devices in the equipment, the CE conformity declaration may no longer apply.

FCC WARNING

This equipment complies with Part 15 of the FCC Rules. Operation is subject to the following two conditions:

- This device may not cause harmful interference, and
- This device must accept any interference received, including interference that may cause undesired operation.

This equipment has been tested and found to comply with the limits for a Class A digital device, pursuant to part 15 of the FCC Rules. These limits are designed to provide reasonable protection against harmful interference when the equipment is operated in a commercial environment. This equipment generates, uses, and can radiate radio frequency energy and, if not installed and used in accordance with the instruction manual, may cause harmful interference to radio communications. Operation of this equipment in a residential area is likely to cause harmful interference in which case the user will be required to correct the interference at his own expense.

Appendix

B

Product Disposal

**CAUTION:**

Risk of explosion if battery is replaced by an incorrect type. Only certified engineers should replace the on-board battery.

Dispose of used batteries according to instructions and local regulations.

- Outside the European Union – If you wish to dispose of used electrical and electronic products outside the European Union, please contact your local authority so as to comply with the correct disposal method.
- Within the European Union – The device that produces less waste and is easier to recycle is classified as electronic device in terms of the European Directive 2012/19/EU (WEEE), and must not be disposed of as domestic garbage.

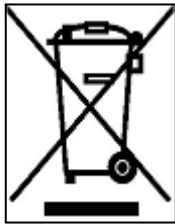

EU-wide legislation, as implemented in each Member State, requires that waste electrical and electronic products carrying the mark (left) must be disposed of separately from normal household waste. This includes monitors and electrical accessories, such as signal cables or power cords. When you need to dispose of your device, please follow the guidance of your local authority, or ask the shop where you purchased the product. The mark on electrical and electronic products only applies to the current European Union Member States.

Please follow the national guidelines for electrical and electronic product disposal.

Appendix

C

BIOS Menu Options

<input type="checkbox"/>	System Date [xx/xx/xx]	67
<input type="checkbox"/>	System Time [xx:xx:xx]	67
<input type="checkbox"/>	Wake system with Fixed Time [Disabled]	69
<input type="checkbox"/>	Console Redirection [Disabled]	70
<input type="checkbox"/>	Legacy Serial Redirection Port [COM1]	71
<input type="checkbox"/>	Terminal Type [ANSI]	72
<input type="checkbox"/>	Bits per second [115200]	73
<input type="checkbox"/>	Data Bits [8]	73
<input type="checkbox"/>	Parity [None]	73
<input type="checkbox"/>	Stop Bits [1]	74
<input type="checkbox"/>	Serial Port [Enabled]	75
<input type="checkbox"/>	Change Settings [Auto]	75
<input type="checkbox"/>	Serial Port [Enabled]	76
<input type="checkbox"/>	Change Settings [Auto]	76
<input type="checkbox"/>	Serial Port [Enabled]	77
<input type="checkbox"/>	Change Settings [Auto]	77
<input type="checkbox"/>	Serial Port [Enabled]	78
<input type="checkbox"/>	Change Settings [Auto]	78
<input type="checkbox"/>	Serial Port Mode [RS232]	78
<input type="checkbox"/>	Serial Port [Enabled]	79
<input type="checkbox"/>	Change Settings [Auto]	79
<input type="checkbox"/>	Serial Port [Enabled]	80
<input type="checkbox"/>	Change Settings [Auto]	80
<input type="checkbox"/>	Serial Port Mode [RS232]	80
<input type="checkbox"/>	PC Health Status	81
<input type="checkbox"/>	CPU_FAN1 Smart Fan Control [Auto Mode]	82
<input type="checkbox"/>	Auto mode fan start temperature [50]	83
<input type="checkbox"/>	Auto mode fan off temperature [40]	83
<input type="checkbox"/>	Auto mode fan start PWM [30]	84
<input type="checkbox"/>	Auto mode fan slope PWM [2]	84
<input type="checkbox"/>	Auto Recovery Function [Disabled]	85
<input type="checkbox"/>	Intel® Virtualization Technology [Enabled]	86
<input type="checkbox"/>	EIST [Enabled]	87
<input type="checkbox"/>	CPU C State Report [Disabled]	87
<input type="checkbox"/>	STAT Configuration [Enabled]	88

WAFER-BW SBC

<input type="checkbox"/>	SATA Mode Selection [AHCI].....	88
<input type="checkbox"/>	Hot Plug [Disabled].....	88
<input type="checkbox"/>	USB Devices.....	90
<input type="checkbox"/>	Legacy USB Support [Enabled].....	90
<input type="checkbox"/>	Memory Information.....	92
<input type="checkbox"/>	Integrated Graphics Device [Enabled].....	93
<input type="checkbox"/>	Primary Display [Auto].....	94
<input type="checkbox"/>	DVMT Pre-Allocated [256MB].....	94
<input type="checkbox"/>	DVMT Total Gfx Mem [Max].....	94
<input type="checkbox"/>	On board LVDS [Enabled].....	94
<input type="checkbox"/>	Backlight Control Mode [CCFL].....	95
<input type="checkbox"/>	LCD Panel Type [800x600 18bit].....	95
<input type="checkbox"/>	Backlight Control Voltage Level [3.3V].....	95
<input type="checkbox"/>	Restore on AC Power Loss [Last State].....	96
<input type="checkbox"/>	Audio Controller [Enabled].....	97
<input type="checkbox"/>	PCIe Speed [Auto].....	97
<input type="checkbox"/>	Detect Non-Compliance Device [Disabled].....	98
<input type="checkbox"/>	Administrator Password.....	98
<input type="checkbox"/>	User Password.....	98
<input type="checkbox"/>	Bootup NumLock State [On].....	99
<input type="checkbox"/>	Quiet Boot [Enabled].....	100
<input type="checkbox"/>	OS Selection [Windows 8.1 & 10].....	100
<input type="checkbox"/>	UEFI Boot [Disabled].....	100
<input type="checkbox"/>	Launch PXE OpROM [Disabled].....	100
<input type="checkbox"/>	Option ROM Messages [Force BIOS].....	101
<input type="checkbox"/>	Boot Option Priority.....	101
<input type="checkbox"/>	Save Changes and Reset.....	102
<input type="checkbox"/>	Discard Changes and Reset.....	102
<input type="checkbox"/>	Restore Defaults.....	102
<input type="checkbox"/>	Save as User Defaults.....	102
<input type="checkbox"/>	Restore User Defaults.....	102

Appendix

D

Digital I/O Interface

WAFER-BW SBC

The DIO connector on the WAFER-BW is interfaced to GPIO ports on the Super I/O chipset. The DIO has both 8-bit digital inputs and 8-bit digital outputs. The digital inputs and digital outputs are generally control signals that control the on/off circuit of external devices or TTL devices. Data can be read or written to the selected address to enable the DIO functions.

**NOTE:**

For further information, please refer to the datasheet for the Super I/O chipset.

The BIOS interrupt call **INT 15H** controls the digital I/O.

INT 15H:

AH – 6FH	
<u>Sub-function:</u>	
AL – 8	: Set the digital port as INPUT
AL	: Digital I/O input value

Assembly Language Sample 1

```
MOV    AX, 6F08H    ; setting the digital port as input
INT    15H          ;
```

AL low byte = value

AH – 6FH	
<u>Sub-function:</u>	
AL – 9	: Set the digital port as OUTPUT
BL	: Digital I/O output value

Assembly Language Sample 2

```

MOV     AX, 6F09H      ; setting the digital port as output
MOV     BL, 09H        ; digital value is 09H
INT     15H           ;
    
```

Digital Output is 1001b

Appendix

E

Watchdog Timer



NOTE:

The following discussion applies to DOS. Contact IEI support or visit the IEI website for drivers for other operating systems.

The Watchdog Timer is a hardware-based timer that attempts to restart the system when it stops working. The system may stop working because of external EMI or software bugs. The Watchdog Timer ensures that standalone systems like ATMs will automatically attempt to restart in the case of system problems.

A BIOS function call (INT 15H) is used to control the Watchdog Timer.

INT 15H:

AH – 6FH Sub-function:	
AL – 2:	Sets the Watchdog Timer's period.
BL:	Time-out value (Its unit-second is dependent on the item "Watchdog Timer unit select" in CMOS setup).

Table E-1: AH-6FH Sub-function

Call sub-function 2 to set the time-out period of Watchdog Timer first. If the time-out value is not zero, the Watchdog Timer starts counting down. When the timer value reaches zero, the system resets. To ensure that this reset condition does not occur, calling sub-function 2 must periodically refresh the Watchdog Timer. However, the watchdog timer is disabled if the time-out value is set to zero.

A tolerance of at least 10% must be maintained to avoid unknown routines within the operating system (DOS), such as disk I/O that can be very time-consuming.

WAFER-BW SBC



NOTE:

The Watchdog Timer is activated through software. The software application that activates the Watchdog Timer must also deactivate it when closed. If the Watchdog Timer is not deactivated, the system will automatically restart after the Timer has finished its countdown.

EXAMPLE PROGRAM:

; INITIAL TIMER PERIOD COUNTER

;

W_LOOP:

;

```

MOV      AX, 6F02H      ;setting the time-out value
MOV      BL, 30         ;time-out value is 48 seconds
INT      15H

```

;

; ADD THE APPLICATION PROGRAM HERE

;

```

CMP      EXIT_AP, 1     ;is the application over?
JNE      W_LOOP        ;No, restart the application

MOV      AX, 6F02H     ;disable Watchdog Timer
MOV      BL, 0         ;
INT      15H

```

;

; EXIT ;

Appendix

F

Hazardous Materials Disclosure

WAFER-BW SBC

The details provided in this appendix are to ensure that the product is compliant with the Peoples Republic of China (China) RoHS standards. The table below acknowledges the presences of small quantities of certain materials in the product, and is applicable to China RoHS only.

A label will be placed on each product to indicate the estimated “Environmentally Friendly Use Period” (EFUP). This is an estimate of the number of years that these substances would “not leak out or undergo abrupt change.” This product may contain replaceable sub-assemblies/components which have a shorter EFUP such as batteries and lamps. These components will be separately marked.

Please refer to the following table.

Part Name	Toxic or Hazardous Substances and Elements					
	Lead (Pb)	Mercury (Hg)	Cadmium (Cd)	Hexavalent Chromium (CR(VI))	Polybrominated Biphenyls (PBB)	Polybrominated Diphenyl Ethers (PBDE)
Housing	O	O	O	O	O	O
Display	O	O	O	O	O	O
Printed Circuit Board	O	O	O	O	O	O
Metal Fasteners	O	O	O	O	O	O
Cable Assembly	O	O	O	O	O	O
Fan Assembly	O	O	O	O	O	O
Power Supply Assemblies	O	O	O	O	O	O
Battery	O	O	O	O	O	O

O: This toxic or hazardous substance is contained in all of the homogeneous materials for the part is below the limit requirement in SJ/T11363-2006 (now replaced by GB/T 26572-2011).

X: This toxic or hazardous substance is contained in at least one of the homogeneous materials for this part is above the limit requirement in SJ/T11363-2006 (now replaced by GB/T 26572-2011).

此附件旨在确保本产品符合中国 RoHS 标准。以下表格标示此产品中某有毒物质的含量符合中国 RoHS 标准规定的限量要求。

本产品上会附有“环境友好使用期限”的标签，此期限是估算这些物质“不会有泄漏或突变”的年限。本产品可能包含有较短的环境友好使用期限的可替换元件，像是电池或灯管，这些元件将会单独标示出来。

部件名称	有毒有害物质或元素					
	铅 (Pb)	汞 (Hg)	镉 (Cd)	六价铬 (CR(VI))	多溴联苯 (PBB)	多溴二苯 醚 (PBDE)
壳体	○	○	○	○	○	○
显示	○	○	○	○	○	○
印刷电路板	○	○	○	○	○	○
金属螺帽	○	○	○	○	○	○
电缆组装	○	○	○	○	○	○
风扇组装	○	○	○	○	○	○
电力供应组装	○	○	○	○	○	○
电池	○	○	○	○	○	○

○: 表示该有毒有害物质在该部件所有物质材料中的含量均在 SJ/T 11363-2006 (现由 GB/T 26572-2011 取代) 标准规定的限量要求以下。

X: 表示该有毒有害物质至少在该部件的某一均质材料中的含量超出 SJ/T 11363-2006 (现由 GB/T 26572-2011 取代) 标准规定的限量要求。