

Vehicle Mounted Computer

Intel Elkhart Lake x6425E Processor, 2.0 GHz

10.4" / 12.1" / 14"

FM-VML Series



User Guide

Contents

Chapter 1: Read Me First	7
1.1 Informations de sécurité (FR)	8
1.2 Safety Information (EN)	8
1.3 About the Adapter	9
1.4 Li-Ion Battery	9
1.5 General Guideline	9
Chapter 2: Introduction	10
2.1 Package Contents	11
2.2 Optional Accessories	11
2.3 Components	12
2.3.1 Front View with FM10E-VML	12
2.3.2 Front View with FM12E-VML	13
2.3.3 Front View with FM14E-VML	14
2.3.4 Rear View with FM10E-VML and FM12E-VML	15
2.3.5 Rear View with FM14E-VML	15
2.3.6 Side View	16
2.3.7 Top and Bottom View	17
Chapter 3: Hardware	18
3.1 Central Processing Unit	18
3.2 Input and Output Connectors	18
3.3 System Memory	18
3.4 Memory Card	18
3.5 WLAN	18
3.6 WWAN (Optional)	18
3.7 Power Cable Installation	19
3.7.1 Wiring the Power Cable	19
3.7.2 Connecting the Power Cable for Testing	19
3.7.3 Connecting the power cable for installation on the vehicle	20
3.8 Power Management Mode	22
3.8.1 Full ON Mode	22
3.8.2 Standby and Sleep Mode	22
3.8.3 Hibernate Mode	22
3.8.4 OFF Mode	23
3.8.5 Ignition Control	23
3.9 Power Control	24
3.9.1 Power Button	24
3.10 Battery	25
3.10.1 UPS Battery	25
3.10.2 Backup Battery	26
3.11 External Connectors	27
3.11.1 Serial Connector (COM1 & COM2)	27
3.11.2 DIDO / Serial Connector (COM1) (Optional)	28
3.11.3 Audio / Serial Connector (COM1) (Optional)	29
3.11.4 CAN Bus / Serial Connector (COM2) (Optional)	30
3.11.5 USB 2.0 Connector	31
3.11.6 LAN Connector	31
3.11.7 Power Connector	32
3.12 External / Vehicle Remote Antenna	33
3.13 Keyboard Options	34
3.13.1 Integrated Keypad for FM10E-VML	34

3.13.2 Integrated Keypad for FM12E-VML	35
3.13.3 Integrated Keypad for FM14E-VML	36
3.13.4 SB Keyboard / Mouse	36
3.14 LED Function	37
3.14.1 Power LED	38
3.14.2 Display Backlight Control	38
Chapter 4: Software.....	39
4.1 Setting Up Windows for the First Time	39
4.2 Setting up Windows 10 IoT Enterprise	39
4.3 Control Panel	42
4.3.1 Using the Touch Screen.....	42
4.3.2 Touch Lock.....	43
4.3.3 Volume Adjustment.....	44
4.3.4 Brightness	44
4.3.5 Function Key Form to access F6~F24	45
4.4 Win-Set Utility	46
4.4.1 System Information.....	46
4.4.2 Win-Set Shortcut Setting.....	47
4.4.3 Blanking Function	49
4.4.4 Scanner Wedge	50
4.4.5 Defroster(Optional)	51
4.5 Ignition Software AP.....	52
4.5.1 DIDO Controller	52
4.5.2 COM port Controller.....	53
4.6 BT	54
4.6.1 Opening My Bluetooth	54
4.7 BT Barcode Reader Setup	54
4.7.1 The VMC with Label	55
4.7.2 The VMC without Label.....	55
4.7.3 Adding and Pairing a BT Device	55
4.8 WLAN	55
4.8.1 Connecting to a Wireless network.....	56
4.9 WWAN(Optional).....	57
4.10 Using Camera Features	59
4.10.1 The Camera Screen	59
4.10.2 Shooting Photos	59
4.10.3 Recording Videos.....	60
4.10.4 Camera Settings	61
4.11 Using Recovery Wizard to Restore Computer.....	62
Chapter 5: Accessories Installation	64
5.1 Installing a SIM Card	64
5.2 Installing a Micro SD Card.....	65
Chapter 6: Vehicle Mounting	66
6.1 Vehicle Mount Instruction	66
6.2 RAM Mount Installation	66
Appendix A: Technical Specifications	71
FM10E-VML.....	71
FM12E-VML.....	72
FM14E-VML.....	73

Copyright

No part of this manual may be reproduce, copied, translated, or transmitted in any form or any means, electronic or mechanical, for any purpose, without the written permission of Winmate Inc.

Trademarks

All product names, trademarks or logos mentioned herein are the properties of their respective owners.

Microsoft, Windows, and the Windows logo are either registered trademarks or trademarks of Microsoft Corporation in the United States and/or other countries. Microsoft products are licensed to OEMs by Microsoft Licensing, Inc., a wholly owned subsidiary of Microsoft Corporation.

The Bluetooth word mark and logos are registered trademarks owned by Bluetooth SIG, Inc.

All other brand and product names are trademarks or registered trademarks of their respective owners.

**NOTE:**

Display images shown may vary slightly from actual display. Information in this manual is subject to change without prior notification.

**NOTE:**

Use the device when located at least 20 cm (7.9 inches) away from the human body.

Disclaimer

Wimate Inc. reserves the right to make any product changes without notice, including circuits and/or software described or contained in this manual in order to improve design and/or performance. Wimate Inc. assumes no responsibility or liability for the use of the described product (s), conveys no license or title under any patent, copyright, or masks work rights to these products, and makes no representations or warranties that these products are free from patent, copyright, or mask work right infringement, unless otherwise specified. Applications that are described in this guide are for illustration purposes only. Wimate Inc. makes no representation or warranty that such application will be suitable for the specified use without further testing or modification.

Warranty

Wimate Inc. warrants that each of its products is free from material and workmanship defect for a period of one year starting from the invoice date. If the customer discovers a defect, Wimate Inc. will, at its option, repair or replace the defective product at no charge to the customer, provided it is returned during the warranty period, with transportation charges prepaid. The returned product must be properly packaged in its original packaging to obtain warranty service.

Advisory Conventions

Four types of advisories are used throughout the user manual to provide helpful information or to alert you to the potential for hardware damage or personal injury. These are Notes, Important, Cautions, and Warnings. The following is an example of each type of advisory.



NOTE:

A note is used to emphasize helpful information



IMPORTANT:

An important note indicates information that is important for you to know.



CAUTION/ ATTENTION

A Caution alert indicates potential damage to hardware and explains how to avoid the potential problem.

Une alerte d'attention indique un dommage possible à l'équipement et explique comment éviter le problème potentiel.



WARNING!/ AVERTISSEMENT!

An Electrical Shock Warning indicates the potential harm from electrical hazards and how to avoid the potential problem.

Un Avertissement de Choc Électrique indique le potentiel de chocs sur des emplacements électriques et comment éviter ces problèmes.

FCC Regulations

This device complies with part 15 of the FCC Rules. Operation is subject to the following two conditions: (1) This device may not cause harmful interference, and (2) this device must accept any interference received, including interference that may cause undesired operation.

This device has been tested and found to comply with the limits for a Class B digital device, pursuant to Part 15 of the FCC Rules. These limits are designed to provide reasonable protection against harmful interference in residential installation. This equipment generates uses and can radiate radio frequency energy and, if not installed and used in accordance with the instructions, may cause harmful interference to radio communications. However, there is no guarantee that interference will not occur in a particular installation. If this equipment does cause harmful interference to radio or television reception, which can be determined by turning the equipment off and on, the user is encouraged to try to correct the interference by one or more of the following measures:

- Reorient or relocate the receiving antenna.
- Increase the separation between the equipment and receiver.
- Connect the equipment into an outlet on a circuit different from that to which the receiver is connected.
- Consult the dealer or an experienced technician for help.

Changes or modifications not expressly approved by the party responsible for compliance could void the user's authority to operate the equipment.

Operation on the 5.15-5.25GHz frequency band is restricted to indoor use only. The FCC requires indoor use for the 5.15-5.25GHz band to reduce the potential for harmful interference to co-channel Mobile Satellite Systems. Therefore, it will only transmit on the 5.25-5.35 GHz, 5.47-5.725 GHz and 5.725 –5.850 GHz band when associated with an access point (AP).

CE Notice (European Union)

This device has been tested and found to conform to the limits set for a Class B product.

- EN 55022 — “Limits and Methods of Measurement of Radio Interference Characteristics of Information Technology Equipment”
- EN 55024 — “Information technology equipment - Immunity characteristics - Limits and methods of measurement”
- EN 61000-3-2 — “Electromagnetic compatibility (EMC) - Part 3: Limits - Section 2”
- EN 61000-3-3 — “Electromagnetic compatibility (EMC) - Part 3: Limits - Section 3”
- EN 60950 — “Safety of Information Technology Equipment”.
- EN 55022 Emissions requirements

RF Exposure Information (SAR)

This device is compliance with SAR for general population /uncontrolled exposure limits in ANSI/IEEE C95.1-1999 and had been tested in accordance with the measurement methods and procedures specified in OET Bulletin 65 Supplement C.

This equipment complies with FCC RF radiation exposure limits set forth for an uncontrolled environment. This device was tested for operations with the device contacted directly to the human body to the back side of the EUT. To maintain compliance with FCC RF exposure compliance requirements, avoid direct contact to the transmitted antenna during transmitting.

IC Regulations

Le présent appareil est conforme aux CNR d'Industrie Canada applicables aux appareils radio exempts de licence. L'exploitation est autorisée aux deux conditions suivantes:

- (1) l'appareil ne doit pas produire de brouillage, et
- (2) l'utilisateur de l'appareil doit accepter tout brouillage radioélectrique subi, même si le brouillage est susceptible d'en compromettre le fonctionnement.”

This device complies with Industry Canada license-exempt RSS standard(s). Operation is subject to the following two conditions:

- (1) This device may not cause interference, and
- (2) This device must accept any interference, including interference that may cause undesired operation of the device.

This Class B digital apparatus complies with Canadian ICES-003

Cet appareil numérique de la classe B est conforme à la norme NMB-003 du Canada.

The device could automatically discontinue transmission in case of absence of information to transmit, or operational failure. Note that this is not intended to prohibit transmission of control or signaling information or the use of repetitive codes where required by the technology.

The device for the band 5150-5250 MHz is only for indoor usage to reduce potential for harmful interference to co-channel mobile satellite systems; the maximum antenna gain permitted (for devices in the bands 5250-5350 MHz and 5470-5725 MHz) to comply with the e.i.r.p. limit; and The maximum antenna gain permitted (for devices in the band 5725-5850 MHz) to comply with the e.i.r.p. limits specified for point-to-point and non-point-to-point operation as appropriate, as stated in section A9.2(3). In addition, High-power radars are allocated as primary users (meaning they have priority) of the band 5250-5350 MHz and this radar could cause interference and/or damage to LE-LAN devices.

The County Code Selection feature is disabled for products marketed in the US/Canada. For product available in the USA/ Canada markets, only channel 1~11 can be operated. Selection of other channels is not possible.

IC Radiation Exposure Statement

This EUT is compliance with SAR for general population/uncontrolled exposure limits in IC RSS-102 and had been tested in accordance with the measurement methods and procedures specified in IEEE 1528

Chapter 1: Read Me First

Follow and adhere to all warnings and instructions in this manual. For your safety, please read all safety and operating instructions before using the product. Keep this manual for future reference.



CAUTION/ ATTENTION

Pour réduire le risque d'incendie ou de choc électrique ne pas exposer l'appareil à la pluie ou à l'humidité. VERIFIER que le cordon électrique est la prise murale pour un délai d'inactivité prolongé. Pour arrêter complètement l'alimentation de l'appareil, débranchez le cordon d'alimentation de la prise AC. N'enlever ni le capot arrière ni les pièces internes de l'appareil. Contactez un personnel qualifié si nécessaire.



SA1965

WARNING!/ AVERTISSEMENT!

Utilisé pour les instructions destinés à alerter l'utilisateur d'un CHOC ÉLECTRIQUE mortel ou de blessure grave en cas d'utilisation incorrecte de l'unité.



SA1966

WARNING!/ AVERTISSEMENT!

Utilisé pour les instructions destinés à alerter l'utilisateur d'un risque mortel ou de blessure grave en cas d'utilisation incorrecte de l'unité.



CAUTION/ ATTENTION

Pour réduire le risque d'incendie ou de choc électrique ne pas exposer l'appareil à la pluie ou à l'humidité FAIRE le cordon électrique est DÉBRANCHÉ DE LA PRISE MURALE DANS UN DELAI DE PROLONGER INACTIVITÉ. De se désengager totalement LE POUVOIR DE L'UNITE, S'IL VOUS PLAÎT DEBRANCHER LE CORDON D'ALIMENTATION DE LA PRISE AC. NE PAS Romove le capot arrière, pas de PIÈCES À L'INTÉRIEUR. Contactez un personnel qualifié S'il faut le réparer.



SA1965

WARNING!/ AVERTISSEMENT!

Sert aux instructions destin es alerter l'utilisateur d'un CHOC ÉLECTRIQUE mortel ou de blessure grave en cas d'utilisation incorrecte de l'unit.



SA1966

WARNING!/ AVERTISSEMENT!

Sert aux instructions destin es alerter l'utilisateur d'un risque mortel ou de blessure grave en cas d'utilisation incorrecte de l'unit .

1.1 Informations de sécurité (FR)

Suivez et respectez tous les avertissements et instructions figurant sur l'écran. Pour votre sécurité, s'il vous plaît lire toutes les consignes de sécurité et de fonctionnement avant d'utiliser le device. Gardez ce manuel pour référence future.

1. Lire avec attention toutes les recommandations et précautions d'emploi avant d'utiliser ce produit.
2. Veuillez conserver ces recommandations et précautions pour référence future.
3. Lire et comprendre tous les avertissements énumérés dans les précautions d'emploi.
4. Suivre toutes les précautions d'emploi pour utiliser ce produit.
5. Utiliser exclusivement un chiffon sec pour nettoyer ce produit.
6. Ne pas placer le produit près de toute source de chaleur telle que radiateurs, arrivées d'air chaud, fourneaux ou autres appareils générant de la chaleur (incluant les amplificateurs producteurs de chaleur) .
7. Ne pas négliger la sécurité que procure un branchement polarisé ou avec raccordement à la terre, Un branchement polarisé comprend deux fiches dont l'une est plus large que l'autre. Un branchement à la terre comprend deux fiches plus une troisième reliée à la terre. Si la fiche secteur fournie ne s'insert pas dans votre prise de courant. consulter un 'électricien afin de remplacer votre prise obsolète.
8. Protéger le cordon d'alimentation de tout écrasement ou pincement, particulièrement au niveau des fiches, des réceptacles utilisés et à l'endroit de sortie de l'appareil. Ne pas casser la fiche de terre du cordon d'alimentation.
9. Utiliser uniquement les accessoires spécifiés par le constructeur.
10. Utilisez seulement des accessoires spécifiés par le fabricant ou vendus avec le produit.
11. Débrancher cet appareil lors d'orages ou s'il n'est pas utilisé pendant une longue période.
12. Faire exécuter le service par du personnel qualifié. Une intervention technique est requise lorsque l'appareil a été endommagé ou n'opère pas normalement.



1.2 Safety Information (EN)

Follow and adhere to all warnings and instructions on the screen. For your safety, please read all safety and operating instructions before using the device. Keep this manual for future reference.

1. Carefully read all recommendations and precautions for use before using this product.
2. Retain all recommendations and precautions for future reference as necessary.
3. Read and be sure to understand all warnings listed in the precautions.
4. Follow all operating precautions when using this product.
5. Use only a dry cloth to clean this product.
6. Do not place the product near any heat sources such as radiators, warm air intakes, stoves or other heat-generating devices (including amplifiers or other heat producing equipment).
7. Do not disregard the safety that a polarized or grounded connection can provide. A polarized connection consists of two plugs, one of which is larger than the other. A grounded connection has two blades and a third one that is grounded. If the main plug provided cannot be inserted into your outlet, consult an electrician to replace your obsolete outlet.
8. Protect the power cord from being crushed or pinched, particularly in the area of the plugs, any receptacles used, and the point of exit from the apparatus. Do not break off the ground pin of the power cord.
9. Use only accessories specified by the manufacturer.
10. Use only with accessories specified by the manufacturer or sold with the product.
11. Unplug this apparatus during lightning storms or when it is not being used for long periods.
12. Refer all servicing to qualified service personnel. A technical intervention is required when the apparatus has been damaged in any way or does not operate normally.



1.3 About the Adapter

- Use only the supplied AC adapter (Rating: Input DC 9-36V DC). Use of another type of AC adapter will result in malfunction and/or danger.
- Do not use the adapter in a high moisture environment. Never touch the adapter when your hands or feet are wet.
- Allow adequate ventilation around the adapter when using it to operate the device or charge the battery. Do not cover the AC adapter with paper or other objects that will reduce cooling. Do not use the AC adapter while it is inside a carrying case.
- Connect the adapter to a proper power source. The voltage requirements are found on the product case and/or packaging.
- Do not use the adapter if the cord becomes damaged.
- Do not attempt to service the unit. There are no serviceable parts inside. Replace the unit if it is damaged or exposed to excess moisture.

1.4 Li-Ion Battery

Your device has UPS battery. The UPS battery is only expected to use for backup under low system loading and without I/O function. When disposing UPS battery, follow local rules and regulations.



WARNING!

Do not dispose the battery with general waste materials.

The following precautions on battery recycling should be observed:

- The battery should be disposed properly according to local regulations;
- The battery should not be damaged or crushed;
- The battery should not be heated or exposed to direct sunlight.

If you are not aware of local regulations on disposing the battery pack, contact our Service Center or sales representatives for more information.



IMPORTANT:

This hot-swap battery is soft-packed. It may have up to 8% inflation in dimensions under the usage in normal conditions. The mechanical design of the device reserves the space for this normal inflation.



WARNING:

If you observe the internal hot-swap battery has been inflated more than normal condition (or the blotch of panel and touch caused by inflated battery), contact our Service Center or sales representative for replacing the battery immediately.



IMPORTANT:

The battery is consumable part. Therefore, it is recommended to replace the battery pack every two years with a new one recommended by Winmate. Contact our Service Center or sales representatives for more information on replacing the battery pack.

1.5 General Guideline

It is recommended to reboot the device when some functions are defect or inactive. If it still can't solve the problems, please contact your dealer or agent.

Chapter 2: Introduction

In the warehouse environment, the ability to mount mobile devices and computers to forklifts, trucks, taggers, and inventory pickers, is essential. From inventory management to order fulfillment, asset tracking, and shipping and receiving, the warehouse floor is complex ecosystem that requires high-efficiency technology to keep it running smoothly.

The FM-VML Series Vehicle Computer runs on a 2.0GHz Intel® Atom™ x6425E of the full Windows version. This Series features a compact panel with a PCAP touch screen. The FM-VML Series VMC offer cost efficiency and device reliability by eliminating the need for a vehicle dock station and offer an all-in-one computer with integrated IO ports. The all-in-one in-vehicle computer has an integrated WWAN, WLAN, and BT function that easily pairs the vehicle mount computer with customers' barcode scanner and enterprise system for quick data collection.

This vehicle-mount computer is built to endure the rigors of the warehouse, and designed to fit seamlessly into forklifts and other warehouse vehicles.

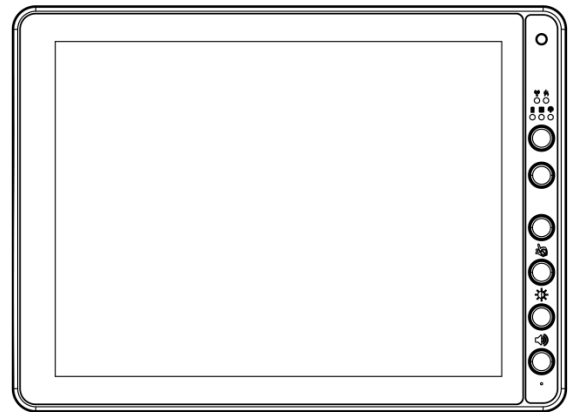
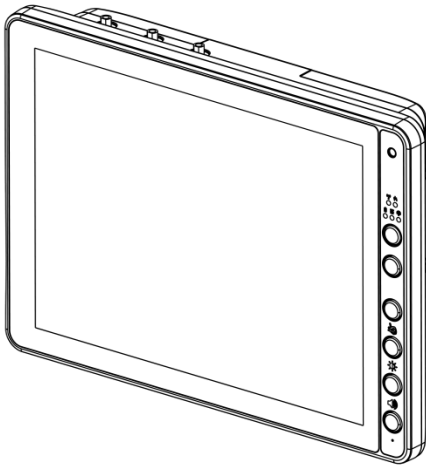
**NOTE:**

Contact our technical support for information on the latest firmware upgrade for your device.

2.1 Package Contents

Before using this device, make sure that all the items listed below are included in your package:



Vehicle Mounted Computer

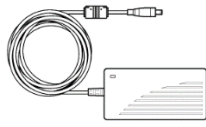

84W Adapter with Power Cable



Quick Start Guide



Power Converter Cable

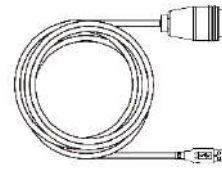

USB Type A Cable

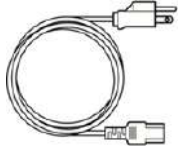

Power Cord

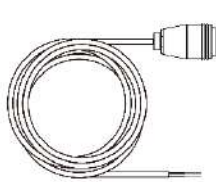

DC Jack Power Cable

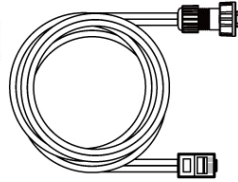

LAN Cable

2.2 Optional Accessories

Your package may include the following items based on your order:

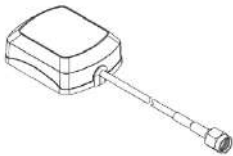

GPS Antenna

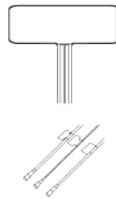

GPS & LTE (VM240)

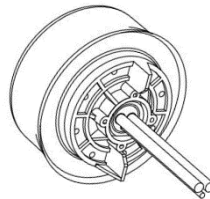

GPS & LTE (VM9C)

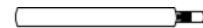

WWAN Antenna

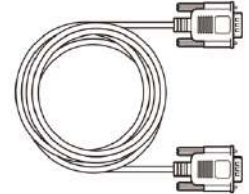

RS232 cable

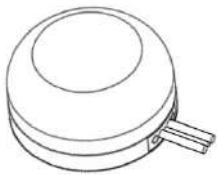

GPS & LTE (VM10S)

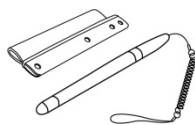

Stylus Kit

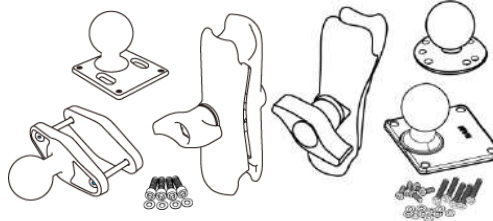

Mounting Kit 1 No Drill



Mounting Kit 2 Drill

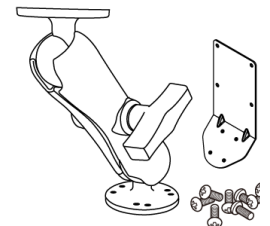





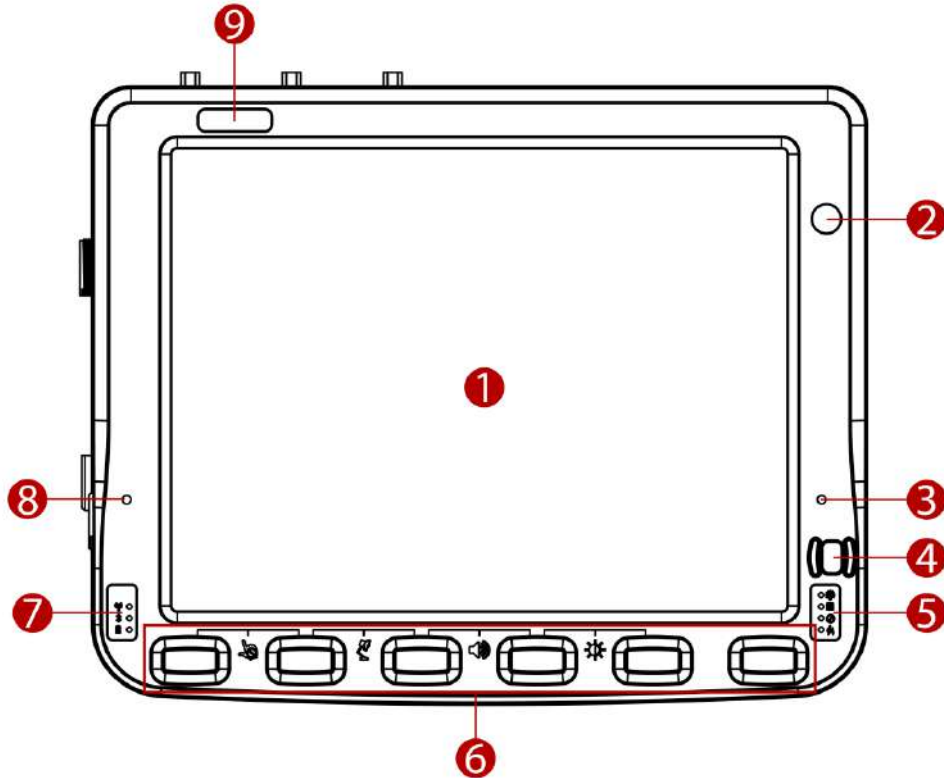

Mounting Kit 3 Keyboard Mounting

2.3 Components





2.3.1 Front View with FM10E-VML

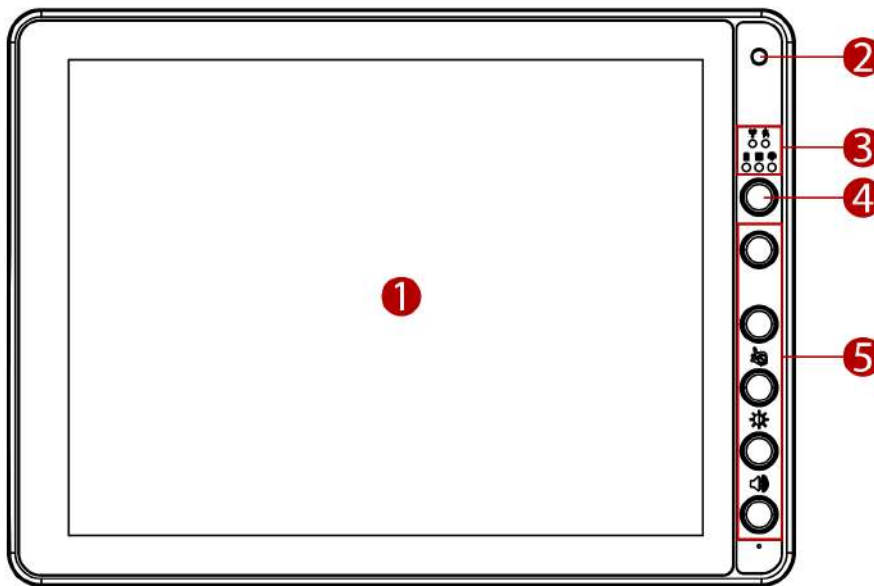

No	Item	Description
1	10.4" Touch Screen	Acts as one of the inputs for the device
2	Camera	2 Megapixel front camera
3	Microphone	For voice communication and voice recording
4	Power Button and Indicator	Press and hold the button for 3 second to turn on the device
5	Light Sensor and LED indicators	 Light Sensor
		 HDD Indicators
		 Blanking Indicators
		 Heater Indicators
6	Function buttons	Programmable Function keys that can be configured by using the Win-Set® Utility
7	LED indicators	 Wi-Fi Indicators
		 Bluetooth Indicators
		 UPS Battery Indicators
8	Digital Microphone	For voice communication and voice recording
9	Label	Space to print the label or company logo





2.3.2 Front View with FM12E-VML

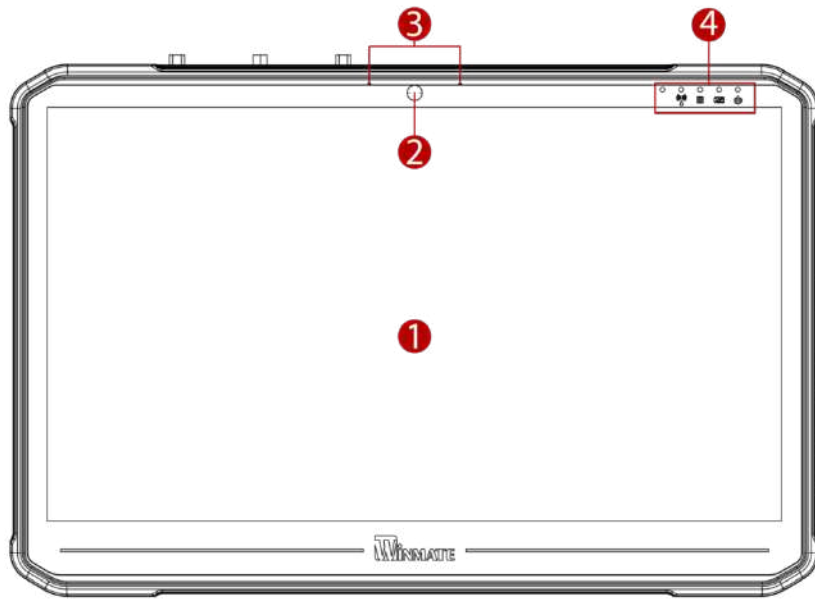

No	Item	Description
1	12.1" Touch Screen	Acts as one of the inputs for the device
2	Camera and Microphone	2 Megapixel front camera with a microphone for voice communication and voice recording
3	Light Sensor and LED indicators	 Wireless communication indicators
		 Defroster indicators (Defroster is customized feature available by request)
		 UPS Battery Indicators
		 HDD indicators
		 Light sensor
4	Power Button and Indicator	Press and hold the button for 3 second to turn on the device
5	Function buttons	Programmable Function keys that can be configured by using the Win-Set® Utility
	Digital Microphone	For voice communication and voice recording

2.3.3 Front View with FM14E-VML



No	Item	Description
1	14" Touch Screen	Acts as one of the inputs for the device
2	Camera	2 Megapixel front camera
3	Microphone	For voice communication and voice recording
4	Light Sensor and LED indicators	 Wi-Fi Indicators
		 UPS Battery Indicators
		 HDD Indicators
		 Power Indicator

2.3.4 Rear View with FM10E-VML and FM12E-VML

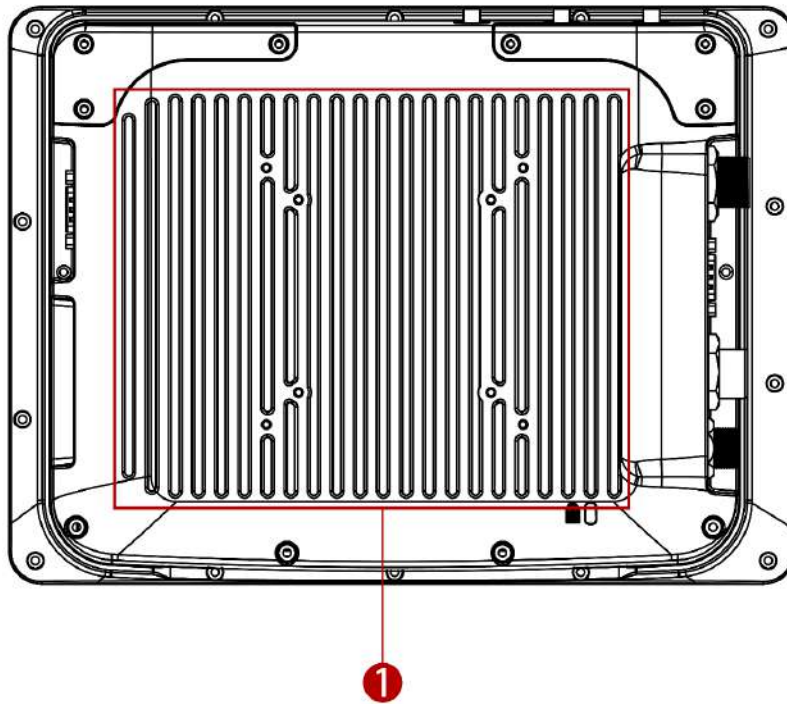

No	Item	Description
1	VESA Mount Hole	VESA 75, 100, and RAM Mount

2.3.5 Rear View with FM14E-VML

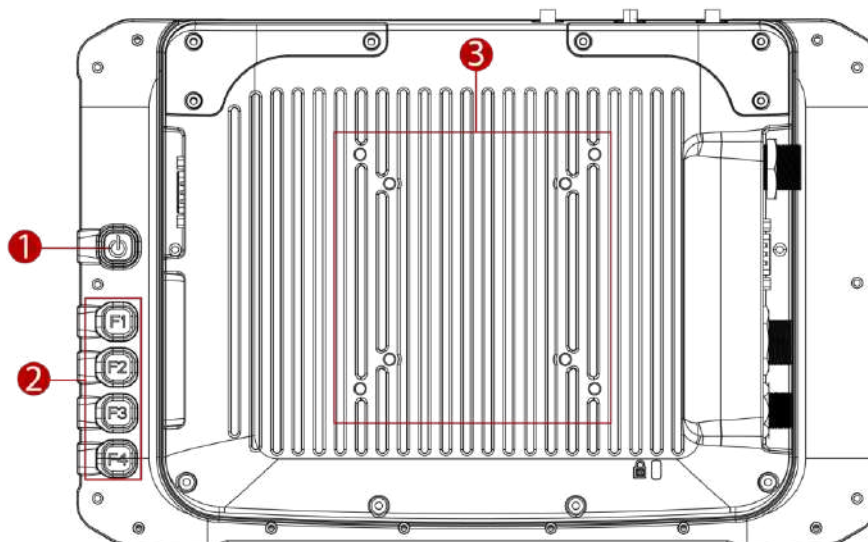

No	Item	Description
1	Power Button	Press and hold the button for 3 second to turn on the device
2	Function buttons	Programmable Function keys that can be configured by using the Win-Set® Utility
3	VESA Mount Hole	VESA 75, 100, and RAM Mount

2.3.6 Side View

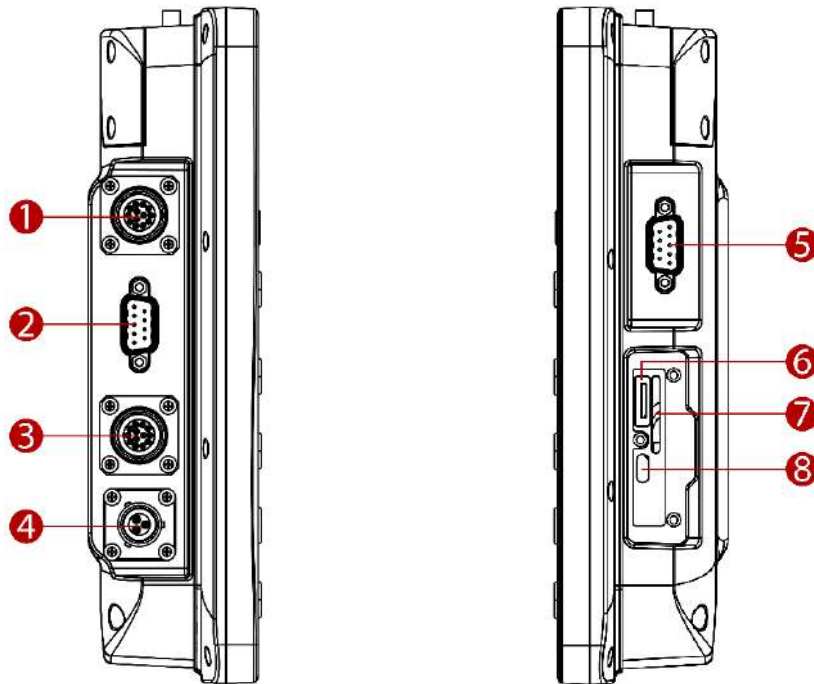

No	Item	Description
1	GIGA LAN	Connects to Ethernet cables to provide data transfer rates of up to 1 Gigabit per second (Gbps), operates at volt levels of 5V or 3.3V
2	D-SUB A: DB9 male with COM1	Connect a peripheral device such as a printer or scanner with serial port. There is 5V DC output on pin 9.
	D-SUB A: DB15 male with COM1+DIDO/Audio (Optional)	DIDO connector allows direct linking into vehicle, enable access to wide range of vehicle data. Audio connector allows connecting headphone or other audio output devices.
3	USB 2.0	Connect to USB cables, offering data transfer rates of up to 480 Mbps
4	Wide Range Power Input	Connect a 9-36V DC IN wide range power input
5	D-SUB B: DB9 male with COM2	Connect a peripheral device such as a printer or scanner with serial port .There is 5V DC output on pin 9.
	D-SUB B: DB15 female with COM2+CANBus (Optional)	CANBus connector allows direct linking into vehicle, enable access to wide range of vehicle data
6	SD Card Slot	Service window to insert MicroSD card.
7	Dual Nano SIM Card Slot*	Service window to insert Nano SIM cards.
8	USB Type-C	A high-speed USB port connects to USB devices.

Note: Service window covers SD Card Slot/ SIM Card Slot and USB Type-C.

Note: For the defroster function please connect a device to a power supply.

2.3.7 Top and Bottom View

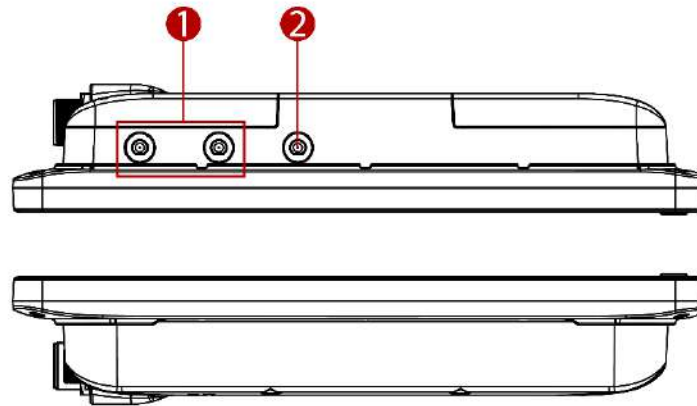

No	Item	Description
1	WWAN Antenna Connector(optional)	Connect a WWAN external antenna and allow the device to be remotely mounted on the vehicle.
2	GPS Antenna Connector(optional)	Connect a GPS external antenna and allow the device to be remotely mounted on the vehicle.

Chapter 3: Hardware

This chapter describes system hardware of FM-VML Series Vehicle Mount Computer.

3.1 Central Processing Unit

The FM-VML Series VMC is running an Intel Elkhart Lake x6425E Processor, 2.0 GHz, and the operating system of this device is Windows 10.

3.2 Input and Output Connectors

The FM-VML Series device supports the following I/O connectors:

- Dual nano-SIM Card Slot
- Micro SD Card Slot
- USB Type-C
- COM Port
- USB 2.0
- LAN Port
- Wide Range Power Input

3.3 System Memory

The main system memory is 4GB SODIMM DDR4-1600 (up to 8GB).

3.4 Memory Card

Your device has a memory card slot which accepts an SD memory card. The memory card is hot swappable.

3.5 WLAN

Your device has an 802.11 a/b/g/n/ac network card that can be used with internal or external antennas.

3.6 WWAN (Optional)

Using a SIM card for network connection, your device supports Wireless Wide Area Networking (WWAN).

3.7 Power Cable Installation

3.7.1 Wiring the Power Cable



WARNING! / AVERTISSEMENT!

This procedure requires a trained service personnel only, improper installation can cause serious damage to the vehicle or the device.

Cette procédure nécessite un personnel de maintenance qualifié uniquement, une mauvaise installation peut causer des dommages importants au véhicule ou le dispositif.

3.7.2 Connecting the Power Cable for Testing



IMPORTANT:

It is highly recommended to purchase the power cable for testing purpose.

Wiring Instruction

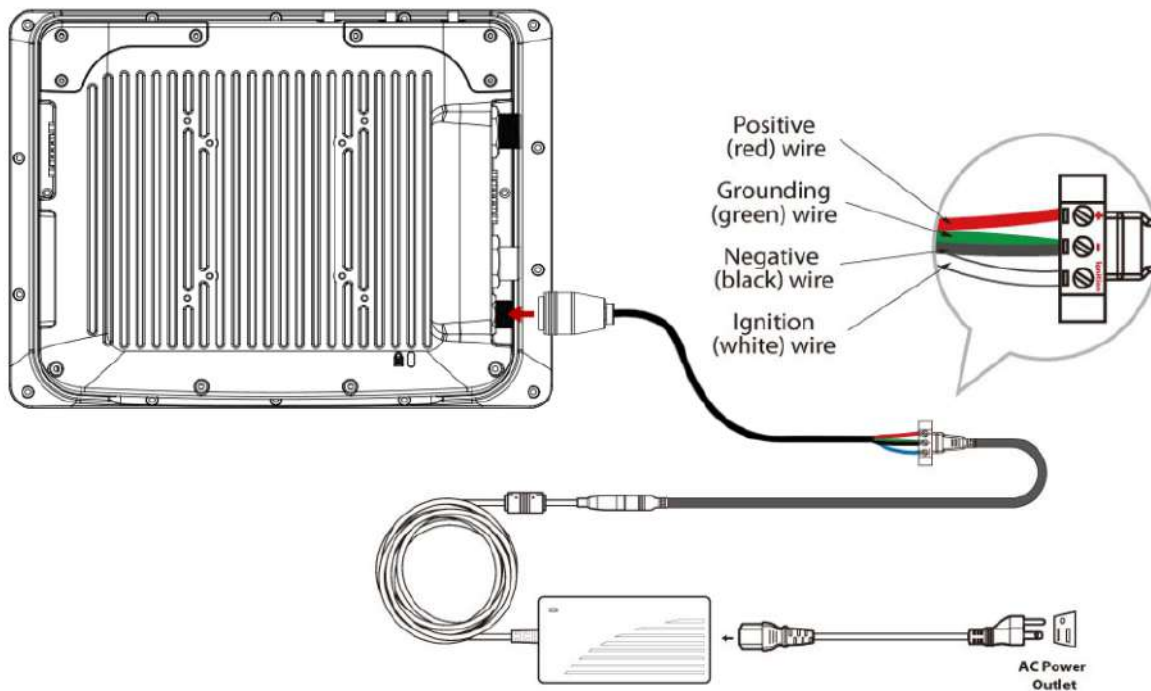

1. Place the device on the vehicle dock and make sure the device is Off.
2. Connect the power cable to the FM-VML Series by aligning the connector pins and then push it, twist to fasten the connection.
3. Connect the AC plug to the electrical outlet.
4. Press the On button, the device is ready for testing.

3.7.3 Connecting the power cable for installation on the vehicle



WARNING! / AVERTISSEMENT!

Select a mounting location and make sure it is not located on the outside the vehicle.
Sélectionnez un emplacement de montage et assurez-vous qu'il ne se trouve pas à l'extérieur du véhicule.



WARNING! / AVERTISSEMENT!

Do not perform the installation on a moving or live electric forklift.
Ne pas effectuer l'installation sur un mobile ou un chariot élévateur électrique sous tension.

Wiring Instruction

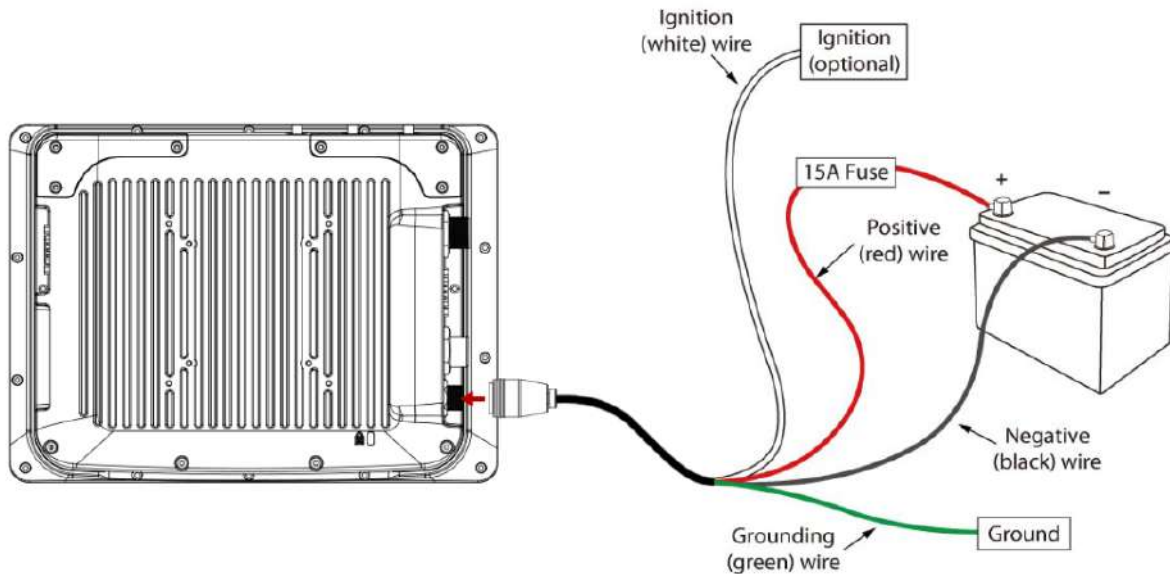

1. Remove the vehicle battery before connecting the power cable
2. Connect the **Green Wire** (Ground) to the vehicle's chassis (grounding), which can also be negative pole of the battery



WARNING! AVERTISSEMENT!

All power wiring must use the supplied power cable.
Tout le câblage électrique doit utiliser le câble d'alimentation fourni.

3. Slide tubing over wires, remove the wires and insert it to the fuse holder, crimp it.
4. Connect the **red** wire to the vehicle's positive power source. Connect the black wire to the vehicle's negative power source.
5. Connect the white wire to the vehicle's ignition switch for the ignition function, if the requirement is connected to vehicle without ignition, please connect ignition pin to battery V+.

Warning! When power is on, ignition pin connects to battery V+ will cause the power consumption even ignition is off

Power cable description:

Color	Symbol
Red	VCC+
Black	VCC-
Green	Ground
White	Ignition input (optional)

With Ignition Function

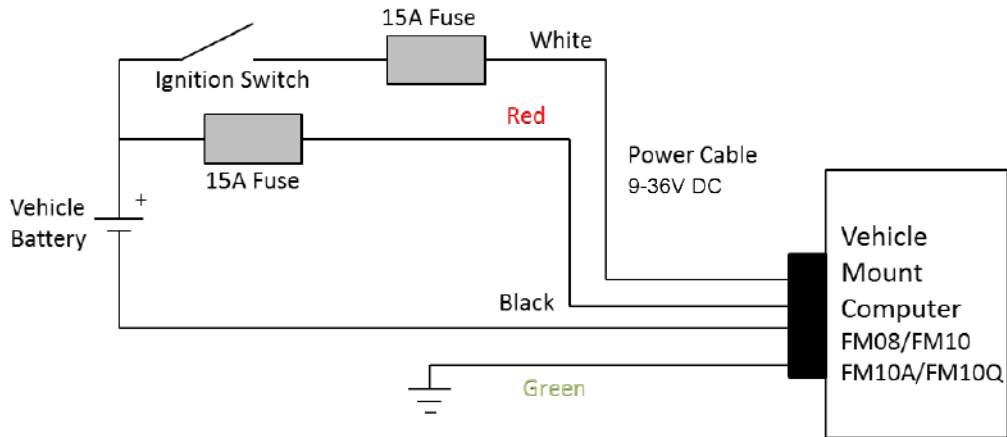

6. The ignition cable (White cable) must be connected to the battery positive if the customer does not want to have ignition function, as following.

Without Ignition Function

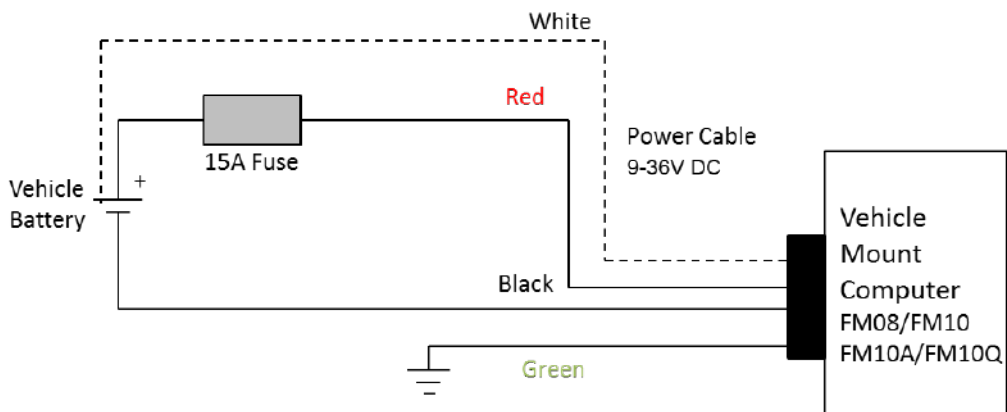

WARNING! / AVERTISSEMENT!

Use the proper cable clamps and do not over tighten it to prevent it from break.









Utilisez les pinces appropriées du câble et ne serrez pas pour l'empêcher de pause.

7. Press the power button on the front of the device See *Power Button*.

3.8 Power Management Mode

The FM-VML Series VMC has four power modes:

- Full ON
- Standby / Sleep
- Hibernate
- OFF

Action	Button		Power Button Backlight	Indicator
Turn On		Press the On button for “2 seconds” until the battery indicator On (solid green) and then release the button	Off	
Standby or Sleep Mode *		Press the On button for “2 seconds” until the screen On and then release the button. The battery indicator will Off after the screen is Off, the system is already in the standby / sleep mode	On	
Wake up		Press the On button for “2 second” until the screen On and then release the button. The battery indicator will On (solid green)	Off	
Turn Off		Press the On button for “4 second” until the system is turns Off and then releases the button.	Off	

3.8.1 Full ON Mode

When the FM-VML Series VMC is attached to either vehicle power or an external power supply and the power button is pressed, the device is in the “ON” mode. In this mode, the keypad, touch screen and any attached peripherals will function normally. The display remains ON until the display, standby or hibernate timer expires.

When the device is in ON mode, the power LED indicators is off.

3.8.2 Standby and Sleep Mode

When the Standby / Sleep timer expires without a primary event occurring, the device transitions to standby / Sleep mode. Press the power button to wake up the device back to ON mode.

When the device is in Standby / Sleep mode, the power LED indicator is red.

3.8.3 Hibernate Mode

When the device is in Hibernate Mode, all LEDs are off, except the power LED indicator is red. Press the power button to wake up the device back to ON mode.

3.8.4 OFF Mode

By default, the FM-VML Series VMC turns off if the user turns off the device through the system or presses the power button for 8 seconds with a critical shut down. The FM-VML Series VMC will also be off when there is no connection to a power source or the UPS battery is depleted. However the internal RTC will keep maintaining the date and time while the device is off. When the device is off, the power LED indicator is red.

3.8.5 Ignition Control

Winmate provides Ignition Software AP to control the timing of delay. Users are able to select 1 to 120 seconds for each period of timing delay. To setup the timing delay please follows these steps:

On Delay: Default 10 seconds. When the system is powered on via ignition key, the system will delay 10 seconds to power on.

Off Delay: Default 10 seconds. When the system is powered off via ignition key, the system will delay 10 seconds to shut down.

Hard Off Delay: Default 30 seconds. When the system is powered off via ignition key, the device will cut off power after 30 seconds.



No	Setting	Default Setting	Description
1	On Delay	10 seconds	When the system is powered on via ignition key, the system will delay 10 seconds to power on.
2	Hard Off Delay	30 seconds	When the system is powered off via ignition key, the device will cut off power after 30 seconds.
3	Off Delay	10 seconds	When the system is powered off via ignition key, the system will delay 10 seconds to shut down.
4	Reset to default	-	Resets the ignition settings back to the default.

3.9 Power Control

3.9.1 Power Button

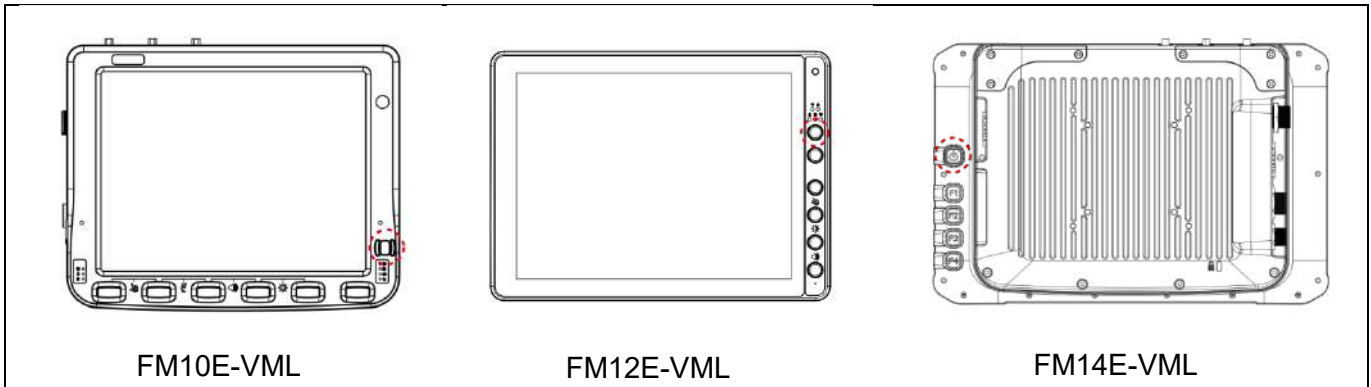

- Power button is located at the lower right side of the FM10E-VML.
- Power button is located at the higher right side of the FM12E-VML.
- Power button is located at the rear side of the FM14E-VML.
- If the device is OFF, pressing the power button will start the power up sequence.

**NOTE:**

- The device has to be connected to the external power or UPS battery has to have a sufficient charge to power the device.
- If no external power available and the UPS battery do not have enough charge, pressing the power button will cause no action.

3.10 Battery

Follow all the instructions in this user manual to prolong the battery life-cycle.



WARNING!

Recharge the battery pack according to the instructions in this user manual.



WARNING!

There is a risk of an explosion caused by incorrect installation or misapplication of the battery pack.

To avoid possible injury:

- Use only the type of the battery recommended by Winmate.
- Follow battery pack installation instructions in this user manual.
- Keep the battery away from fire.
- Store in a cool dry place.
- Do not expose to heat, water and rain.



WARNING!

Do not drop, puncture, and crush the battery unit. If you notice any damages on the battery, stop using the battery and replace it.

3.10.1 UPS Battery

Your device has UPS battery. This UPS battery is automatically charged when the device is connected to the external power. The charging time takes approximately 2 hours. The UPS battery is only expected to use for backup under low system loading and without I/O function.

When running on the UPS battery power, the power timeouts maybe different than when vehicle power is applied. Using the UPS battery power, it allows the device to continue operation even when the device is not connected to the external power. The UPS battery is designed to supply power to your device for a minimum of 20 minutes.

To use the UPS battery to operate the system, please follow these steps:

1. Open Win-Set

2. Press the  button next to Switch to Back-Up Power.

3. Then there will be a window shows up at the center of the desktop and asks you to confirm whether you are ready for hot swapping or not. Then press Ready for hot swapping to finish this step.

System Information	Function Buttons	Blanking Function	Scanner Wedge	Defroster (if equipped)	Exit
PC Information					
BIOS Version	V109				
EC Version	109FM12				
Win-Set Version	3.19.1(FM12)				
OS Version	95Z_0405_221219				
Serial Number	123456789				
Model Name	FM10E				
Battery Health	Good				
<input type="checkbox"/> Check for Update					
Password	<input type="button" value="Set Password"/>				
Touch Mode	<input type="button" value="Set"/>				
Switch to Back-Up Power	<input type="button" value="Set"/>				

System Information	Function Buttons	Blanking Function	Scanner Wedge	Defroster (if equipped)	Exit
PC Information					
BIOS	Version				
EC	Version				
Win	Set Version				
OS	Version				
Serial	Number				
Model	Name				
Battery Health	Good				
<input type="checkbox"/> Check for Update					
Password	<input type="button" value="Set Password"/>				
Touch Mode	<input type="button" value="Set"/>				
Switch to Back-Up Power	<input type="button" value="Set"/>				

Warning Message

The system is going to switch to back-up power.

1. Please connect the main power within 10 minutes.

2. During using UPS battery, the system performance will be reduced. Please save the data before applying.

**IMPORTANT:**

- If the UPS battery power becomes critically low, the device will automatically hibernate to prevent damage to the UPS battery;
- Unable to turn on a device through UPS Battery
- The internal UPS battery status LED and the UPS battery control panel can be used to monitor the status of the UPS battery.

**IMPORTANT:**

Charge the hot-swap battery together with main battery whenever your device is not being used/ charged for three months. Connect the device to the source of power for 1.5 hours to charge.

**WARNING!**

If you leave the device without charging for more than three months, the risk of the battery inflation increases.

3.10.2 Backup Battery

Your device has a backup battery to maintain time, date, and CMOS setup information.

**IMPORTANT:**

The battery is consumable part. Therefore, it is recommended to replace the battery pack every two years with a new one recommended by Winmate. Contact our Service Center or sales representatives for more information on replacing the battery pack.

**WARNING!**

The backup battery should be replaced only by authorized service personnel.

3.11 External Connectors

Power OFF the FM-VML Series VMC before connecting cables to any port.

3.11.1 Serial Connector(COM1 & COM2)

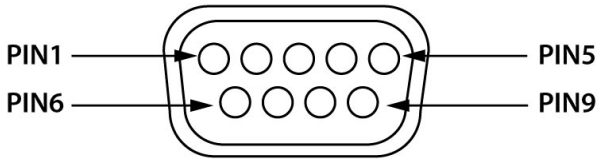

Pin	Signal	Description
1	DCD	Data Carrier Detect – Input
2	RXD	Receive Data – Input
3	TXD	Transmit Data – Output
4	DTR	Data Terminal Ready – Output
5	GND	Signal / Power Ground
6	DSR	Data Set Ready – Input
7	RTS	Request to send – Output
8	CTS	Clear to send – Input
9	+5 VDC	Barcode Scanner Power – 500mA Max

3.11.2 DIDO / Serial Connector (COM1) (Optional)

The Serial and DIDO connector is a DB-15 male connector located on the left side of the device. The connector supports a DIDO cable or a COM port cable.

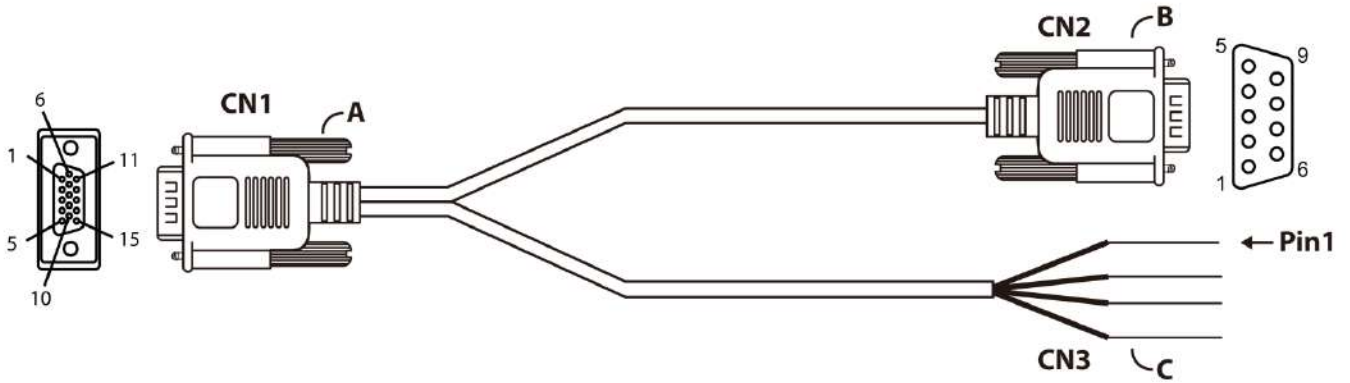

Pin No.	Symbols		Pin No.	Symbols
CN1-1	DCD	↔	CN2-1	DCD
CN1-2	RXD	↔	CN2-2	RXD
CN1-3	TXD	↔	CN2-3	TXD
CN1-4	DTR	↔	CN2-4	DTR
CN1-5	GND	↔	CN2-5	GND
CN1-6	DSR	↔	CN2-6	DSR
CN1-7	RTS	↔	CN2-7	RTS
CN1-8	CTS	↔	CN2-8	CTS
CN1-9	5V	↔	CN2-9	5V
CN1-10	DIO_5V	↔	CN3-1	DIO_5V
CN1-11	DIN_1	↔	CN3-2	DIN_1
CN1-12	DIN_0	↔	CN3-3	DIN_0
CN1-13	DOUT_1	↔	CN3-4	DOUT_1
CN1-14	DOUT_0	↔	CN3-5	DOUT_0
CN1-15	GND	↔	CN3-6	GND

3.11.3 Audio / Serial Connector (COM1) (Optional)

The Serial and Audio connector is a DB-15 male connector located on the left side of the device. The connector supports a Audio cable or a COM port cable.

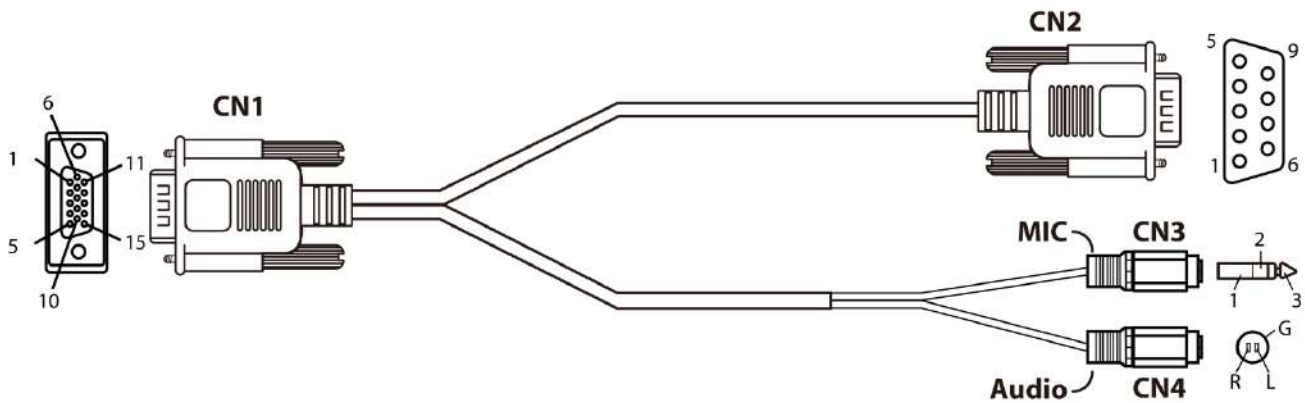

Pin No.	Symbols		Pin No.	Symbols
CN1-1	DCD	↔	CN2-1	DCD
CN1-2	RXD	↔	CN2-2	RXD
CN1-3	TXD	↔	CN2-3	TXD
CN1-4	DTR	↔	CN2-4	DTR
CN1-5	GND	↔	CN2-5	GND
CN1-6	DSR	↔	CN2-6	DSR
CN1-7	RTS	↔	CN2-7	RTS
CN1-8	CTS	↔	CN2-8	CTS
CN1-9	5V	↔	CN2-9	5V
CN1-10	MIC	↔	CN3-3	MIC
CN1-11	AUGND	↔	CN3-1	GND
CN1-12	HP_JD	↔	CN4-1	GND
CN1-13	HP_R	↔	CN4-2	HP_R
CN1-14	FP_L	↔	CN4-3	FP_L

3.11.4 CAN Bus / Serial Connector (COM2) (Optional)

The Serial and CANBus connector is a DB-15 female connector located on the right side of the device. The connector supports a CANBus cable or a COM port cable.

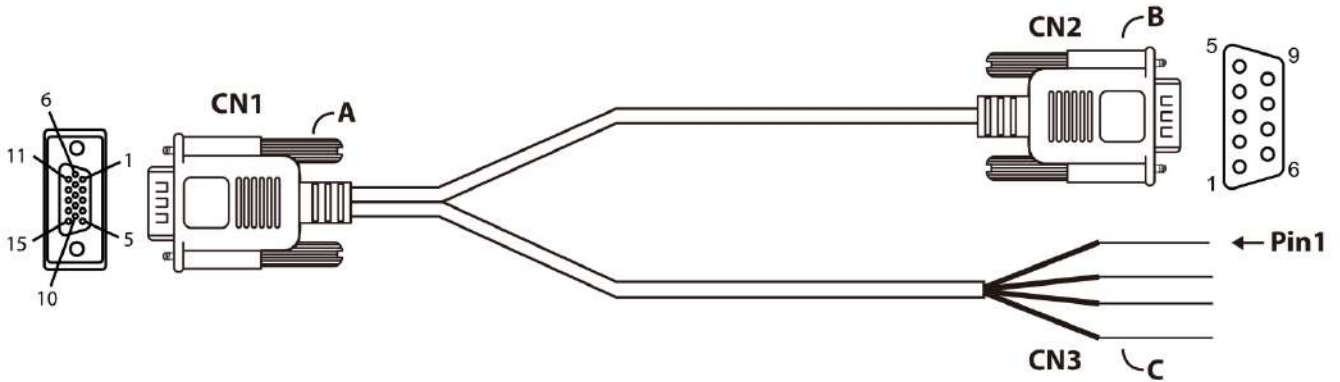

Pin No.	Symbols		Pin No.	Symbols
CN1-1	DCD	↔	CN2-1	DCD
CN1-2	RXD	↔	CN2-2	RXD
CN1-3	TXD	↔	CN2-3	TXD
CN1-4	DTR	↔	CN2-4	DTR
CN1-5	GND	↔	CN2-5	GND
CN1-6	DSR	↔	CN2-6	DSR
CN1-7	RTS	↔	CN2-7	RTS
CN1-8	CTS	↔	CN2-8	CTS
CN1-9	5V	↔	CN2-9	5V
CN1-10	DIO_5V	↔	CN3-1	DIO_5V
CN1-11	CAN_H	↔	CN3-2	DIN_1
CN1-12	CAN_L	↔	CN3-3	DIN_0
CN1-13				
CN1-14				
CN1-15	GND	↔	CN3-4	GND

3.11.5 USB 2.0 Connector

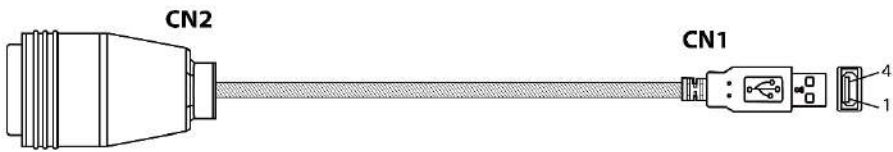

Pin No.	Symbols	Color
CN1-1	USB_5V	Red
CN1-2	USB_GND	Black
CN1-3	USB_D-	White
CN1-4	USB_D+	Green
CN1-5	NC	
CN1-6	NC	
CN1-7	NC	
CN1-8	NC	
CN1-9	NC	
CN1-10	NC	
CN1-11	NC	
CN1-12	NC	
CN1-13	NC	

Pin No.	Symbols	Color
CN2-1	USB_5V	Red
CN2-2	USB_GND	Black
CN2-3	USB_D-	White
CN2-4	USB_D+	Green

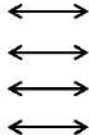

3.11.6 LAN Connector



Pin No.	Symbols	Color
CN1-1	LAN_MDI0+	White/Orange
CN1-2	LAN_MDI0-	Orange
CN1-3	LAN_MDI1+	White/Green
CN1-4	LAN_MDI2+	Blue
CN1-5	LAN_MDI2-	White/Blue
CN1-6	LAN_MDI1-	Green
CN1-7	LAN_MDI3+	White/Brown
CN1-8	LAN_MDI3-	Brown
CN1-9	NC	
CN1-10	NC	
CN1-11	NC	
CN1-12	NC	
CN1-13	NC	

Pin No.	Symbols	Color
CN2-1	LAN_MDI0+	White/Orange
CN2-2	LAN_MDI0-	Orange
CN2-3	LAN_MDI1+	White/Green
CN2-4	LAN_MDI2+	Blue
CN2-5	LAN_MDI2-	White/Blue
CN2-6	LAN_MDI1-	Green
CN2-7	LAN_MDI3+	White/Brown
CN2-8	LAN_MDI3-	Brown

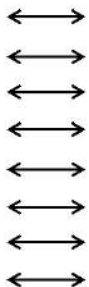

3.11.7 Power Connector

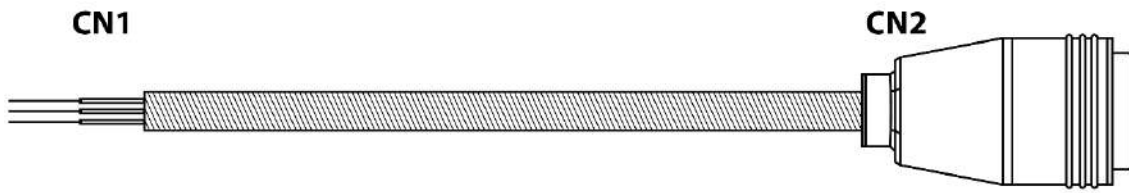

Pin No.	Symbols	Color		Pin No.	Symbols	Color
CN1_+	VCC+	Red	↔	CN2-A	VCC+	Red
CN1_-	VCC-	Black	↔	CN2-B	VCC-	Black
CN1_G	Ignition	Yellow	↔	CN2-C	Ignition	Yellow

3.12 External / Vehicle Remote Antenna

The FM-VML Series is equipped with SMA Connector for additional external antenna (optional WWAN and GPS), to install the antenna please perform the following:

1. Remove the rubber cap on the SMA connector before installing the antenna.
2. Align the antenna with the SMA connector and fasten it as following picture.

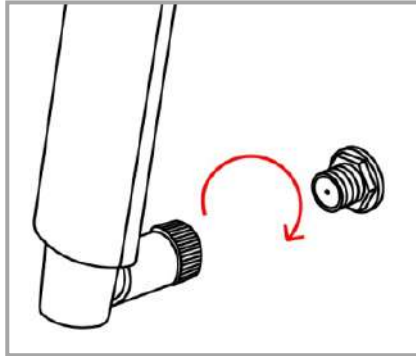

3. Adjust the position of external antennas.

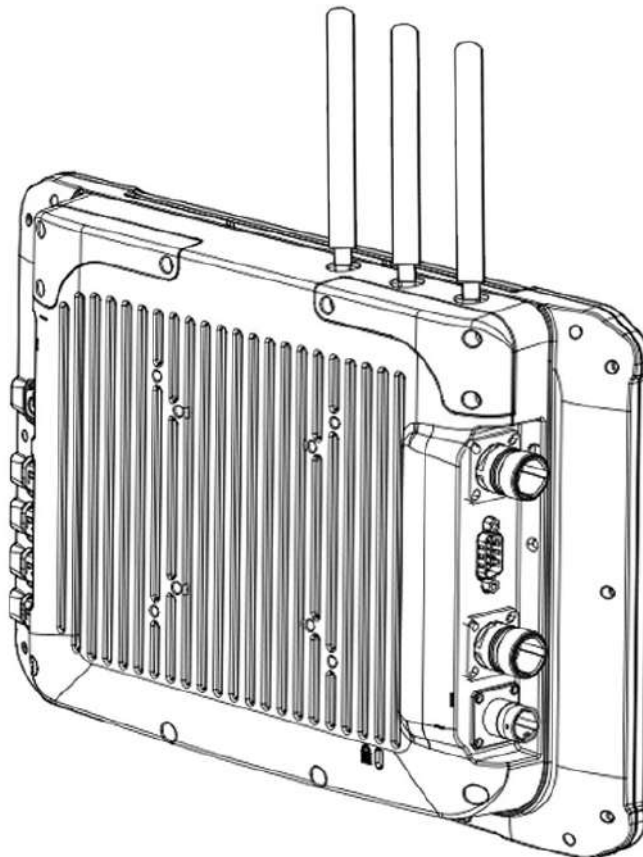

WWAN Antenna Installation

3.13 Keyboard Options

The integrated keypad contains several programmable keys, which are user-programmable keys.

Key Mapping is configured via the Win-Set ® utility on the control panel. See the Programmable key to remap these keys.

3.13.1 Integrated Keypad for FM10E-VML

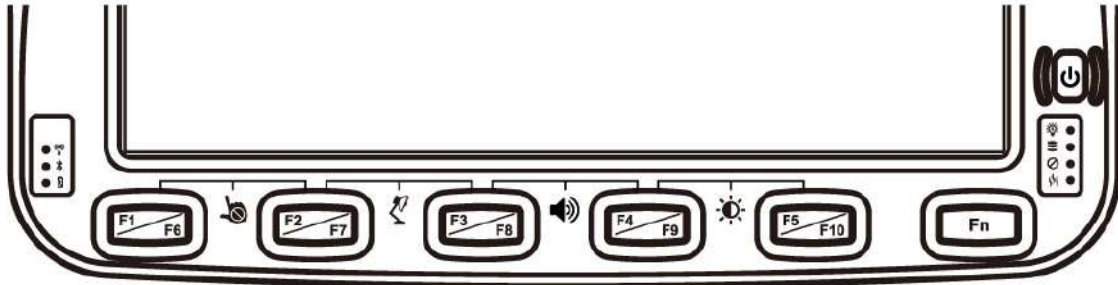

The FM10E-VML has ten programmable keys from F1 to F10.

The default values for these keys are:

Press these keys in this order	Default Key Value
F1+F2	Touch Keypad Lock/Unlock
F3+F4	Volume adjustment
F4+F5	Brightness adjustment (Panel + Keypad)
Long Press on F1	Open WinSet
Long press on F4	RF Hot Tab Function
Long press on F5	Camera
Press on Fn	Function key form F6~F10
Long press on Fn	Function key form F11~F24

*Sign plus “+” means that you have to press both function keys at the same time.

To Get this Programmable Key	POST Key
F1 (Programmable Key 1)	Recovery
F2 (Programmable Key 2)	ESC
F3 (Programmable Key 3)	F3 Key
F4 (Programmable Key 4)	F4 Key
F5 (Programmable Key 5)	F5 Key
F6 (Programmable Key 6)	Enter
F7 (Programmable Key 7)	Up Key
F8 (Programmable Key 8)	Down Key
F9 (Programmable Key 9)	Left Key
F10 (Programmable Key 10)	Right Key

3.13.2 Integrated Keypad for FM12E-VML

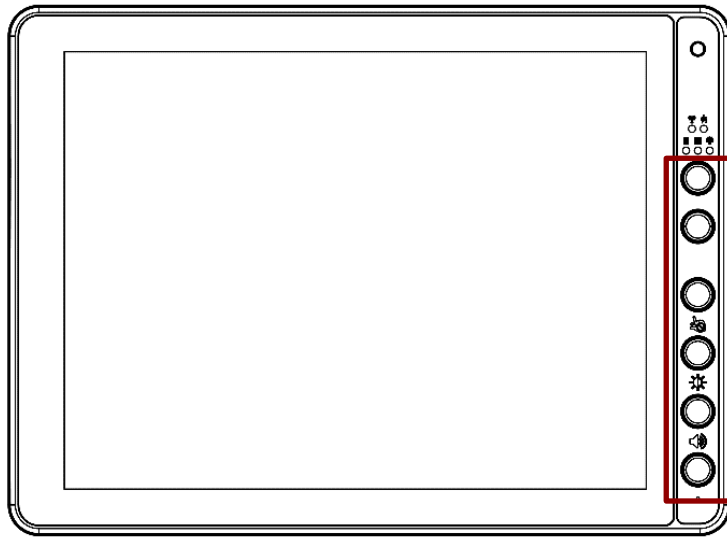

The FM12E-VML has eight programmable keys from F1 to F8.

The default values for these keys are:

Press these keys in this order	Default Key Value
F1+F2	Touch Keypad Lock/Unlock
F2+F3	Brightness adjustment (Panel+keypad)
F3+F4	Volume adjustment
Long press on F1	Open WinSet
Long press on F2	RF Hot Tab Function
Long press on F4	Camera
Press on Fn	Function key form F5~F8

*Sign plus “+” means that you have to press both function keys at the same time.

To Get this Programmable Key	POST Key
F1 (Programmable Key 1)	Recovery
F2 (Programmable Key 2)	ESC
F3 (Programmable Key 3)	Enter
F4 (Programmable Key 4)	F4 Key
F5 (Programmable Key 5)	Up Key
F6 (Programmable Key 6)	Down Key
F7 (Programmable Key 7)	Left Key
F8 (Programmable Key 8)	Right Key

3.13.3 Integrated Keypad for FM14E-VML

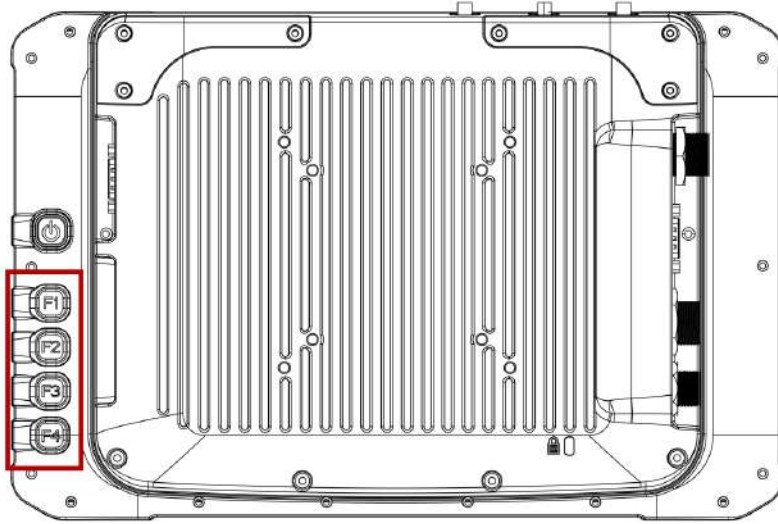

The FM14E-VML has four programmable keys from F1 to F4.

The default values for these keys are:

Press these keys in this order	Default Key Value
F1+F2	Touch Keypad Lock/Unlock
F2+F3	Brightness adjustment (Panel+keypad)
F3+F4	Volume adjustment
Long press on F1	Open WinSet
Long press on F2	RF Hot Tab Function
Long press on F4	Camera

*Sign plus “+” means that you have to press both function keys at the same time.

To Get this Programmable Key	POST Key
F1 (Programmable Key 1)	Recovery
F2 (Programmable Key 2)	ESC
F3 (Programmable Key 3)	F3 Key
F4 (Programmable Key 4)	F4 Key

3.13.4 SB Keyboard / Mouse

A standard USB keyboard or mouse can be attached to the FM-VML Series VMC using the appropriate adapter cable. The cable attached to the device and provides USB connector.

3.14 LED Function

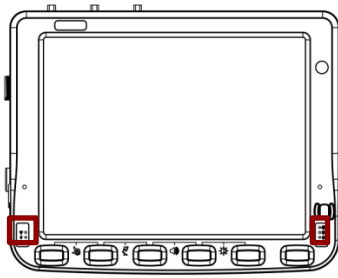



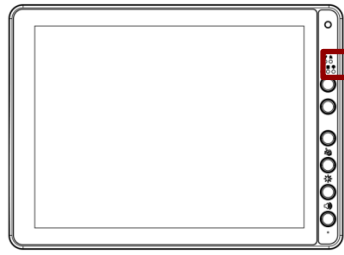



FM10E-VML



FM12E-VML



FM14E-VML

Indicator Type	LED Behavior	System State
 Wi-Fi	ON	The Device has detected a network and is connecting
	OFF	No Network connection
 Bluetooth	ON	The devices are successfully connected and active.
	OFF	The Bluetooth function is disabled
 UPS Battery	Orange	The external power is plugged in and the UPS battery is being charged
	Green	The UPS battery is in use and its power level is more than 10%
	Blinking Red	The UPS battery is low (<10%)
	OFF	The external power is plugged in and the UPS battery is fully charged The device is mounted on the vehicle dock and the UPS battery is fully charged
 Light Sensor	-	Light sensor automatically adjusts the panel brightness based on the light settings.
 HDD Indicators	Blinking Green	Indicates the HDD Activity (Data is being read and written)
	OFF	No HDD Activity
 Blanking Indicators	Solid Red	Blanking function is ON
	OFF	Blanking function is OFF
 Heater Indicators	Solid Red	The Defroster is ON
	OFF	The Defroster is OFF

3.14.1 Power LED

Power LED of FM10E-VML and FM12E-VML is located on the power button. Power LED behavior is shown at the table below.

Indicator Type	LED Behavior	System State
 Power	Solid Red	System off and in suspend mode
	OFF	System On

Power LED of FM14E-VML is located on the upper side of the front panel. Power LED behavior is shown at the table below.

Indicator Type	LED Behavior	System State
 Power	Solid Blue	System On
	OFF	System off and in suspend mode

3.14.2 Display Backlight Control

This device is equipped with automatic brightness adjustment that controls the screen brightness according to the lighting environment. To enable automatic brightness adjustments, go to **Settings > Display > Brightness > Tap Auto**.

Chapter 4: Software

4.1 Setting Up Windows for the First Time

This chapter details how to setup the Windows that may be installed on the tablet for the first time.



Caution Make sure the battery is full charged before starting the Tablet Computer for the first time with internal battery power.

Attention Assurez-vous que la batterie est complètement chargée avant de démarrer la tablette PC pour la première fois avec la batterie interne.

- **Public network:** Select this location if you do not recognize all the computers on the network. (For example, you are in a coffee shop or airport, or you have mobile broadband.) This is a public network and is *not* trusted. Select the location where you will most often use the computer.

4.2 Setting up Windows 10 IoT Enterprise

Follow the steps below to complete the Windows 10 IoT Enterprise setup process.

1. Press the power button to turn on the computer.
2. First, select your country/region, your preferred app language, your preferred keyboard layout, and your time zone, then tap **Next**.

Hi there

Let's get a few basic things out of the way.

What's your home country/region?

United States

What's your preferred app language?

English (United States)

What keyboard layout would you like to use?

US

What time zone are you in?

(UTC-08:00) Pacific Time (US & Canada)

Next

3. On the **Here's the legal stuff** screen, read through the disclosures, then tap **Accept**.

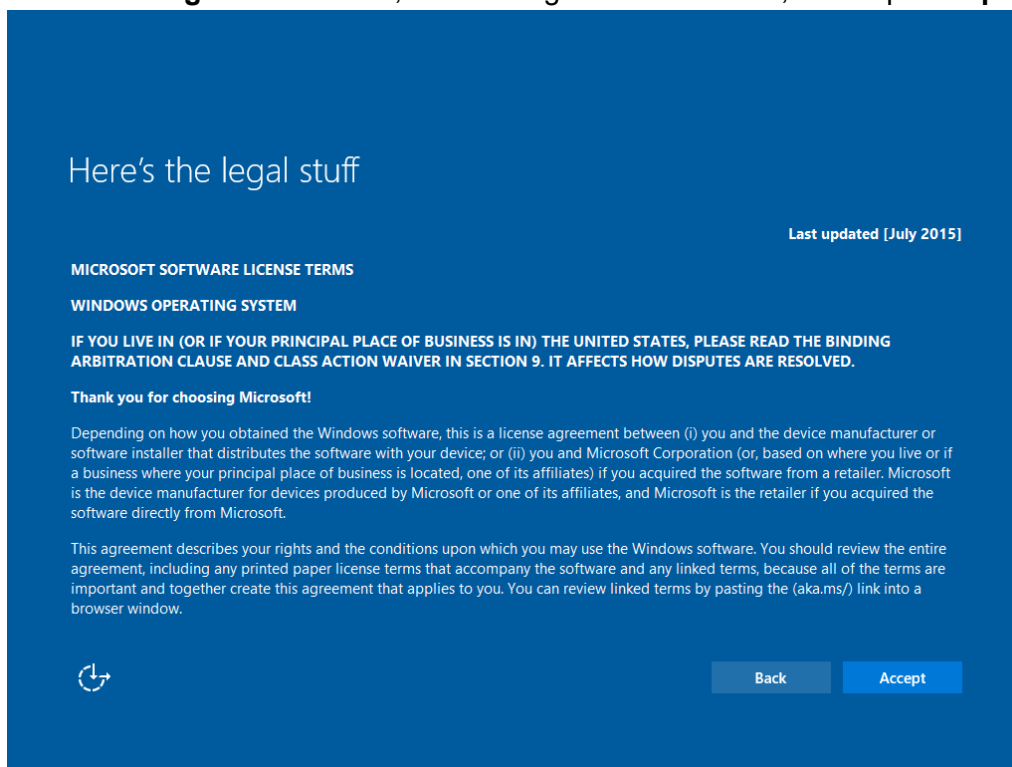

4. Windows will then try to connect to network. Tap **Skip this step** to continue without a wireless connection as you can then set up the network later.
5. On the **Get going fast** screen, click **Use Express settings** for the fastest setup. If you would like more information, tap **Learn more**, or if you would like to select your own options, click **Customize settings**.

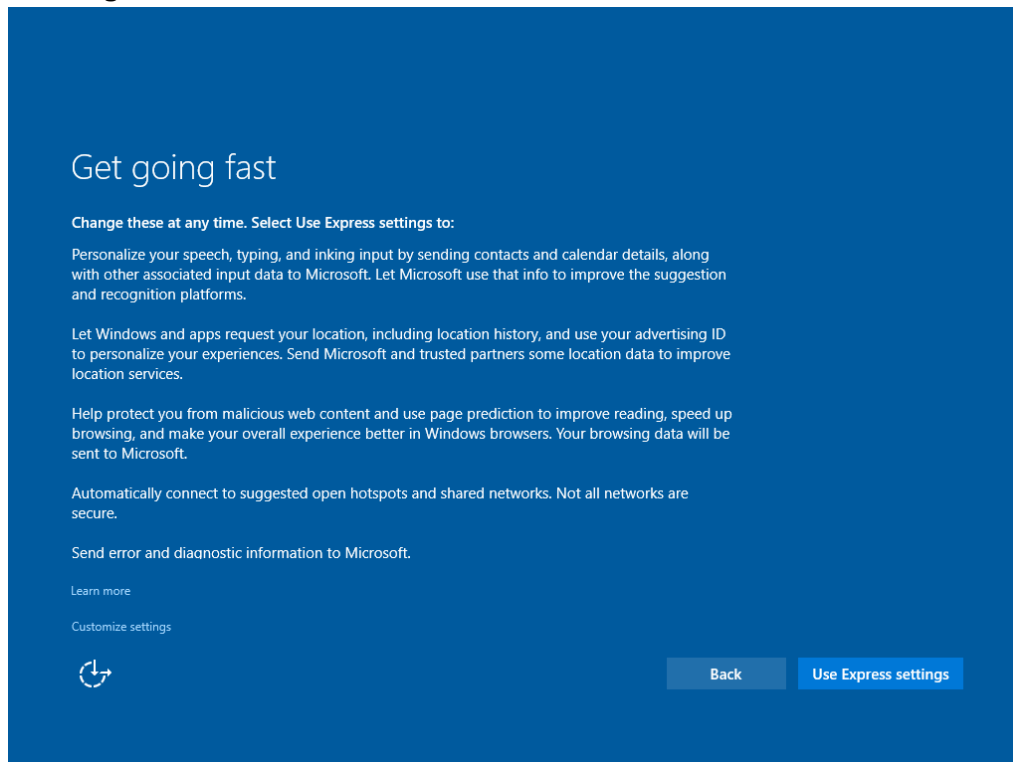

- To create a local account, type your User name, password, and Password hint in the fields provided, then tap **Next**.

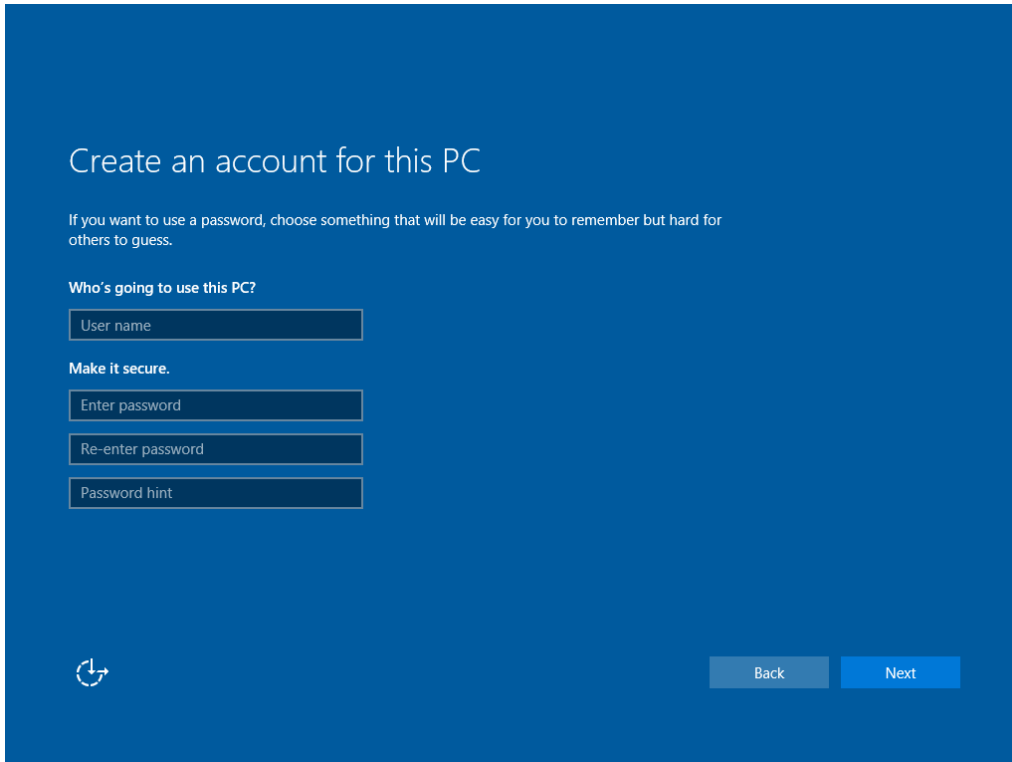

The screenshot shows a blue background with white text. At the top, it says "Create an account for this PC". Below that, a smaller line of text reads: "If you want to use a password, choose something that will be easy for you to remember but hard for others to guess." Underneath, the heading "Who's going to use this PC?" is followed by a text input field labeled "User name". Below this, the heading "Make it secure." is followed by three stacked text input fields: "Enter password", "Re-enter password", and "Password hint". At the bottom left is a circular arrow icon, and at the bottom right are two buttons: "Back" and "Next".

- The initial setup screens are complete, and the desktop is displayed.
- Read any introductory screens describing features of your computer, and tap **Next** upon completing each. You are now done with the initial setup process.

4.3 Control Panel

4.3.1 Using the Touch Screen





The touch screen is a touch-sensitive device that allows you to control and make selections on the device by controlling the location of the pointer on the screen.



NOTE:

Do not use sharp or pointed objects on the touch screen. These objects may scratch the screen. Use only the stylus pen or the tip of your finger.

Here are some common terms when using the touch screen.

Gesture	Action	Description
Single Tap		Tap gently on the touch screen to select or open an item. Tapping is the same as clicking the left mouse button of a pc
Double-tap		Rapidly tap twice on the touch screen. This action is similar to double-clicking the left mouse button of a pc
Press and hold		Press and hold the finger/ stylus lightly on the display. A big circle appears to indicate that a pop-up menu will soon appear. Lift up the stylus and a pop-up menu appears. Select the desired function. This action is similar to a right mouse click on a pc
Drag		Hold the finger/ stylus on the screen and drag across the screen to select text and images or move icons to a new location

4.3.2 Touch Lock

Press F1 and F2 simultaneously to perform touch lock. While the touch is locked, all function keys and touch will not be able to work, until you slide the bar to unlock the touch lock.



Press F1 and F2 simultaneously one more time to perform unlock touch function, or you can slide the bar to unlock the touch lock.



4.3.3 Volume Adjustment

Press F3 and F4 simultaneously to perform volume adjustment. The adjustment slide bar will appear on screen transparently. Slide to the right side to increase the volume and slide to the left side to decrease the volume.



4.3.4 Brightness

There are several configuration options for the FM-VML Series VMC display backlight:

4.3.4.1 Power Management

The display backlight is controlled by power management. When the user activity timer expires, the display backlight is turned off.

4.3.4.2 Display and Keypad Backlight Brightness

The intensity of the display backlight can be manually configured:

1. FM10E-VML: Press the F4 and F5 button simultaneously ;FM12E-VML/FM14E-VML : Press the F2 and F3 button simultaneously; the transparent slide bar will appear on the screen.
2. Tap on the Auto Brightness. you can adjust the brightness for Panel.
3. If the Auto Brightness is not selected, you can adjust panel brightness and keypad brightness individually.
4. Tap on left side of the bar to decrease the brightness; and tap on right side of the bar to increase the brightness.



4.3.5 Function Key Form to access F6~F24

Notice that this function is for FM10E-VML/FM12E-VML and may not be present in your device.

Press on Fn button to call the Fn key form of other function key, performing like the following picture.

Long press on Fn button one more time, to call the Fn key form of other function key (F11~F24), performing like the following picture.

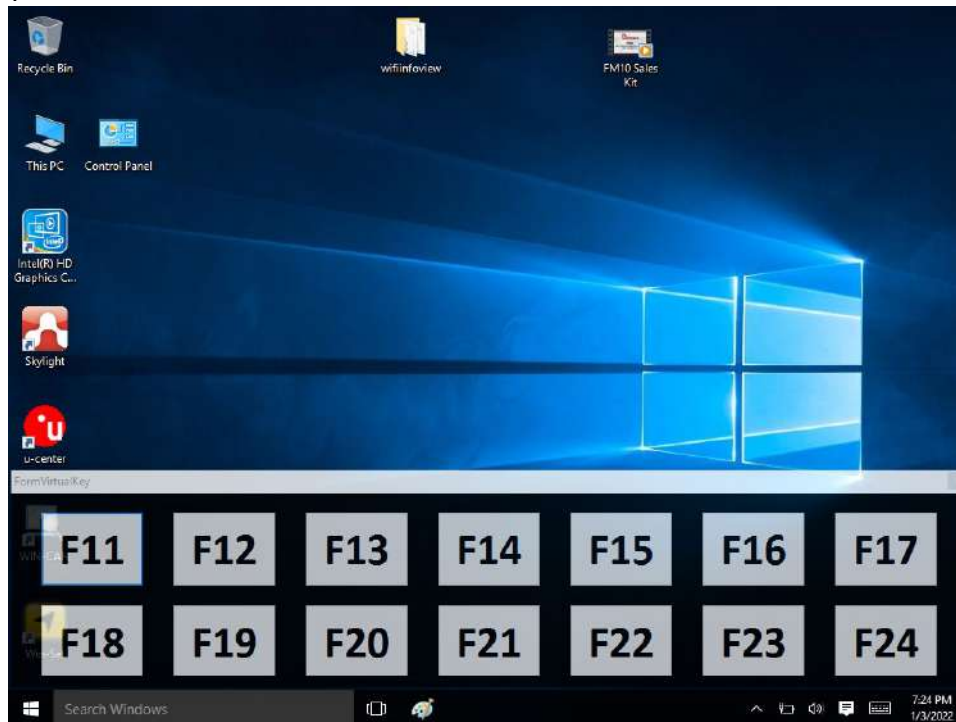

4.4 Win-Set Utility

Win-Set ® is a program made by Winmate to control the main functions of the FM-VML Series. In Win-Set ® user can check system information, control function button settings, configure blanking function, scanner wedge and defroster settings.

Long-press F1 button to open Win-Set ®. User also can open Win-Set ® by double-clicking on Win-Set icon on the desktop.

4.4.1 System Information

System information menu displays main information about this computer.

System Information	Function Buttons	Blanking Function	Scanner Wedge	Defroster (if equipped)	Exit
PC Information					
BIOS Version	V109				
EC Version	109FM12				
Win-Set Version	3.19.1(FM12)				
OS Version	95Z_040S_221219				
Serial Number	123456789				
Model Name	FM10E				
Battery Health	Good				
<input type="checkbox"/> Check for Update					
Password	<input type="button" value="Set Password"/>				
Touch Mode	<input type="button" value="Set"/>				
Switch to Back-Up Power	<input type="button" value="Set"/>				

4.4.2 Win-Set Shortcut Setting

Long pressing on F1 button opens a Win-Set ®. In Function Buttons submenu user can set up functions of the function keys.

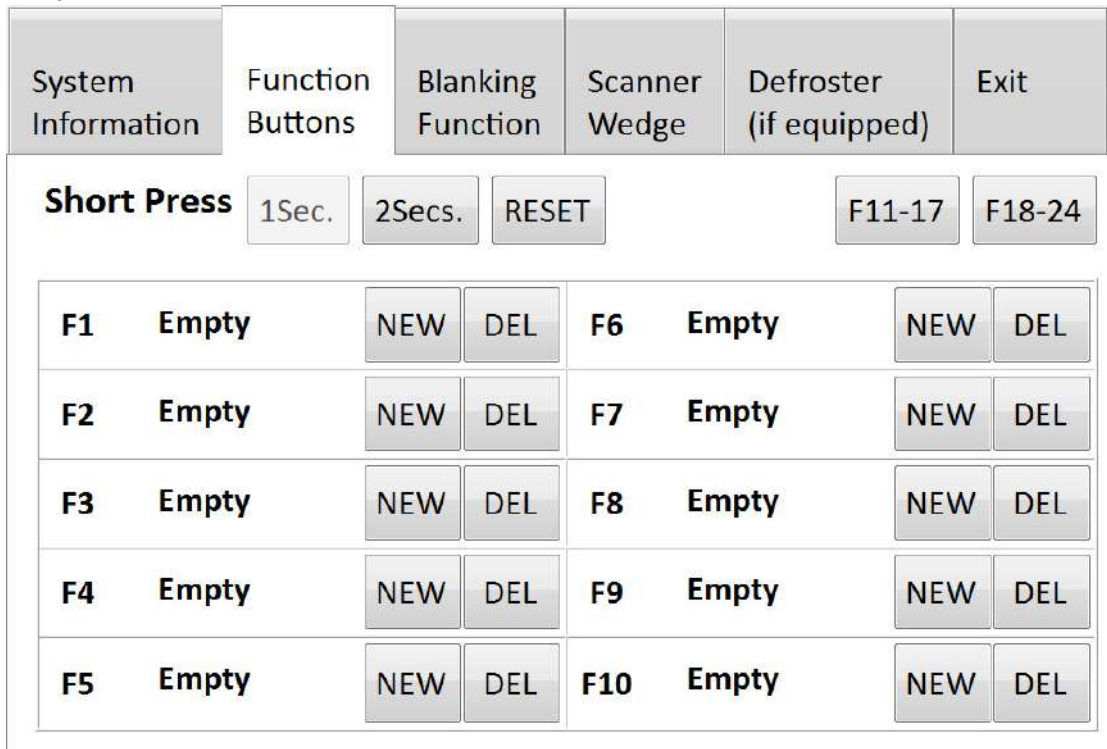

Press the **NEW** button next to F1, user will see the window show up just like the below picture. Then choose a program to be opened by button F1 next time.

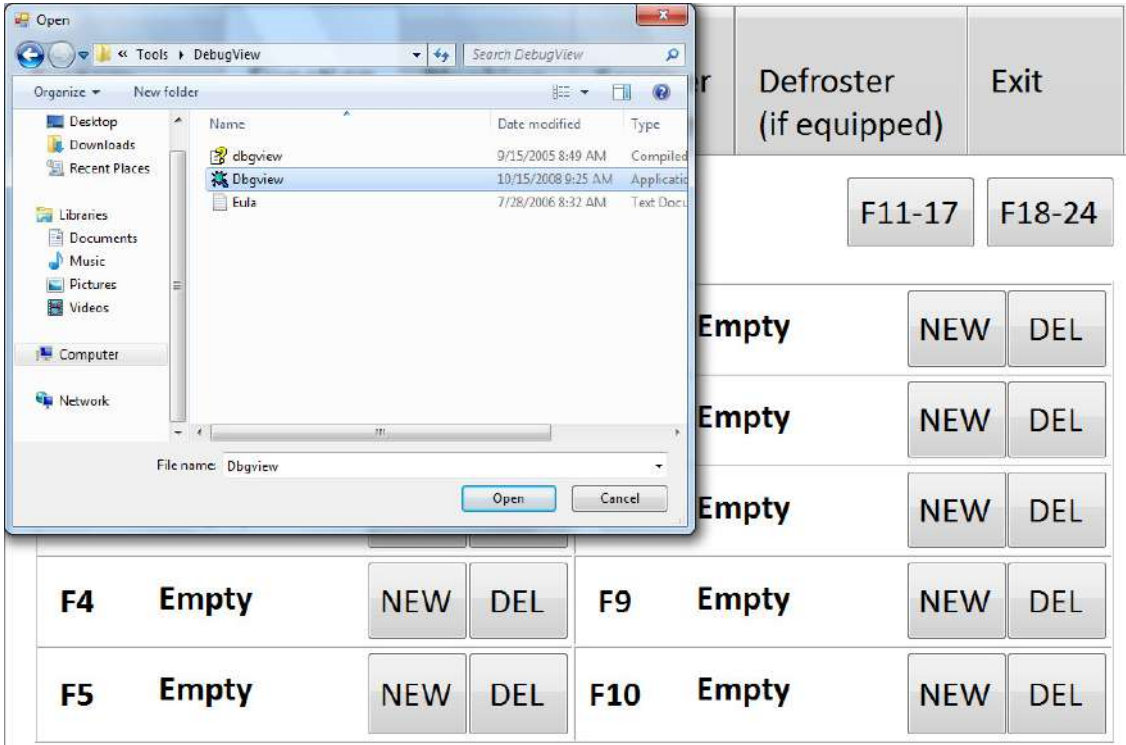

In this example **Dbgview** program will be opened by pressing F1.

If user wants to delete this function, please press the  button next to F1 in the Win-Set ® Function Buttons menu.

System Information		Function Buttons		Blanking Function		Scanner Wedge		Defroster (if equipped)		Exit	
Short Press											
1Sec.		2Secs.		RESET		F11-17		F18-24			
F1	Dbgview	NEW	DEL	F6	Empty	NEW	DEL				
F2	Empty	NEW	DEL	F7	Empty	NEW	DEL				
F3	Empty	NEW	DEL	F8	Empty	NEW	DEL				
F4	Empty	NEW	DEL	F9	Empty	NEW	DEL				
F5	Empty	NEW	DEL	F10	Empty	NEW	DEL				

Then there will be a window show up at the center of the desktop and ask you to confirm whether you want to delete this function or not. Then press Yes to finish this step.

System Information		Function Buttons		Blanking Function		Scanner Wedge		Defroster (if equipped)		Exit	
Short Press											
1Sec.		2Secs.		RESET		F11-17		F18-24			
F1	Dbgview	NEW	DEL	F6	Empty	NEW	DEL				
F2	Empty	NEW	DEL	F7	Empty	NEW	DEL				
F3	Empty	NEW	DEL	F8	Empty	NEW	DEL				
F4	Empty	NEW	DEL	F9	Empty	NEW	DEL				
F5	Empty	NEW	DEL	F10	Empty	NEW	DEL				

Confirm

 Please confirm to delete F1 short press shortcut?



Yes No

4.4.3 Blanking Function

Winmate® FM-VML Series equipped with screen blanking function. Once activated, it will lock the screen display to prevent or restrict the use of the in-vehicle computer.

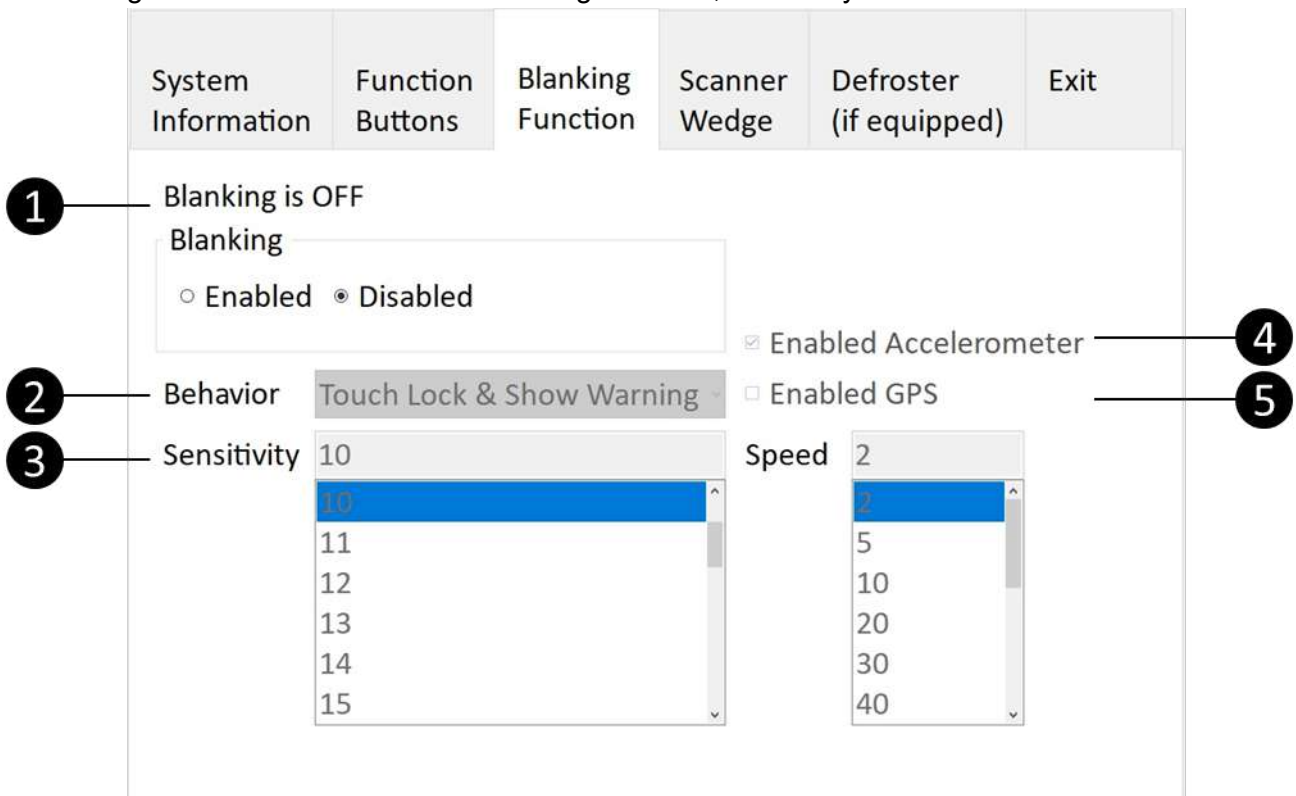
Open Blanking Function menu to control blanking behavior, sensitivity and debounce time.



Item	Setting	Setting Options	Description
1	Blanking	<ul style="list-style-type: none"> Enabled Disabled 	Blanking function reduces visual, cognitive, and physical distractions by limiting device functionality while the vehicle is in motion.
2	Behavior	Touch Lock & Show Warning	Screen is going blank and touch lock icon appears at the bottom side of the screen. 
		Touch Lock	Locks screen and touch lock icon appears at the bottom side. 
		Screen Off	Screen goes blank and will be unlocked according to sensitivity and denounce time preset.
3	Sensitivity	7~200	Set up gyro sensitivity parameters.
4	Enabled Accelerometer		Increase G-sensor sensitivity.
5	Enabled GPS	2~120	Increase vehicle acceleration sensitivity.

4.4.4 Scanner Wedge

Scanner wedge allows user to choose how to interface the Barcode Scanner to the FM-VML Series.

Item	Setting	Setting Options	Description
1	Ports	<ul style="list-style-type: none"> None COM1 COM2 	Choose None, COM1 or COM2 and press Set button  .
2	Output to	Keyboard Wedge SDK Remote Desktop	Data sent through a wedge appears as if it was typed into the computer, while the keyboard itself remains fully functional. The data will be sent to the folder inside SDK. Data appears on the remote desktop.
3	Settings	Settings menu	Opens scanner wedge configuration settings.
4	Clear	-	Clears settings.

4.4.5 Defroster(Optional)

In cold storage, outdoor or in intermodal facilities condensation may appear on the screen. A defroster clears condensation and thaw frost from the screen. Notice that Defroster is an optional feature for the FM10E-VML / FM12E-VML and may not be present in your device.

To show the defroster status open Win-Set  and go to the Defroster sub-menu to see the information about the defroster.



IMPORTANT:

The defroster is always **disabled** when the device is operating from UPS battery power.

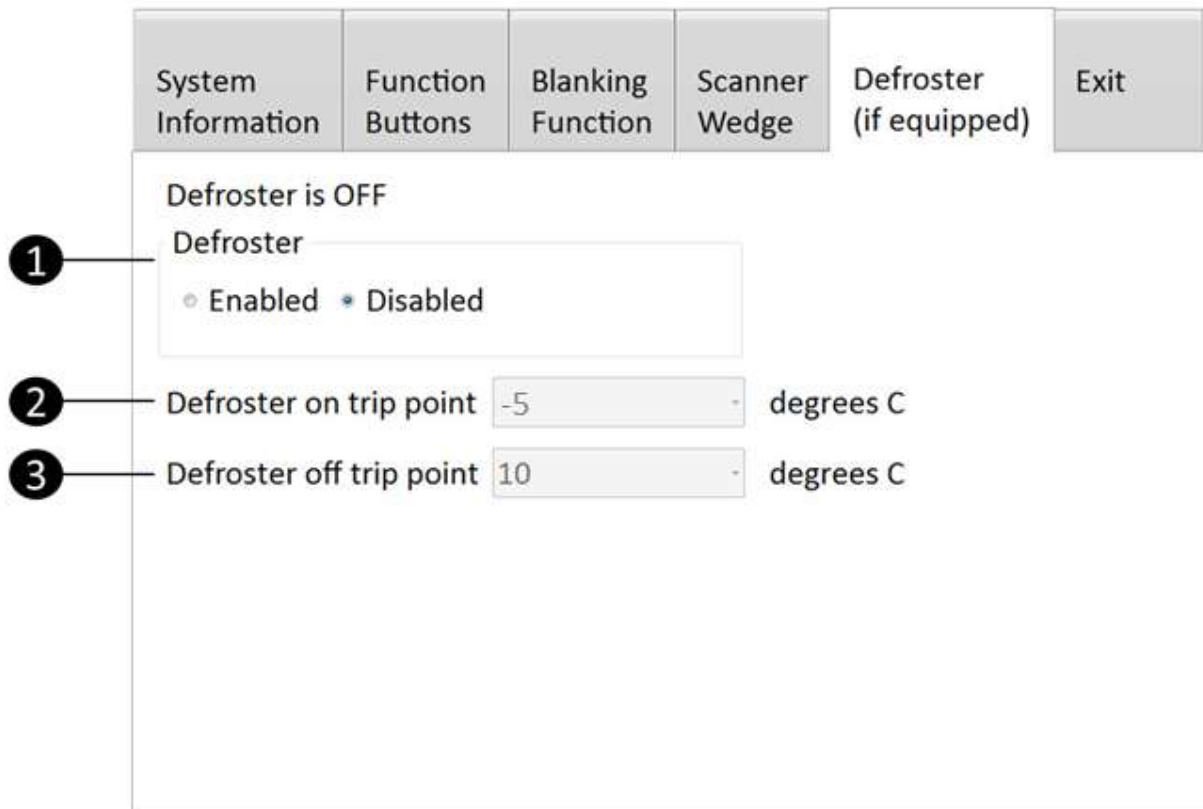

Item	Setting	Setting Options	Default Setting	Description
1	Defroster	Enabled	Disabled	Enables the defroster.
		Disabled		Disables the defroster.
2	Defroster on trip point	-30 ~ 0°C	Default: -5°C	When enabled, defroster automatically starts working when the outside temperature drops down to defroster on trip point (°C)
3	Defroster off trip point	+5°C, +10°C	Default: +10°C	When enabled, defroster automatically stop working when the outside temp. reaches defroster off trip point (°C)

Press Exit  button to close the Win-Set menu and go back to the desktop.

4.5 Ignition Software AP

Ignition Software AP is a program made by Winmate to control the ignition, COMport, and DIDO functions of the FM-VML Series.

To launch the Ignition Software AP, press  and tap on Ignition Software AP Icon. Operations and functions on each menu options are explained in detail in the coming section.

4.5.1 DIDO Controller

Tap on the Ignition Software AP Icon and choose Launch Advanced Window.

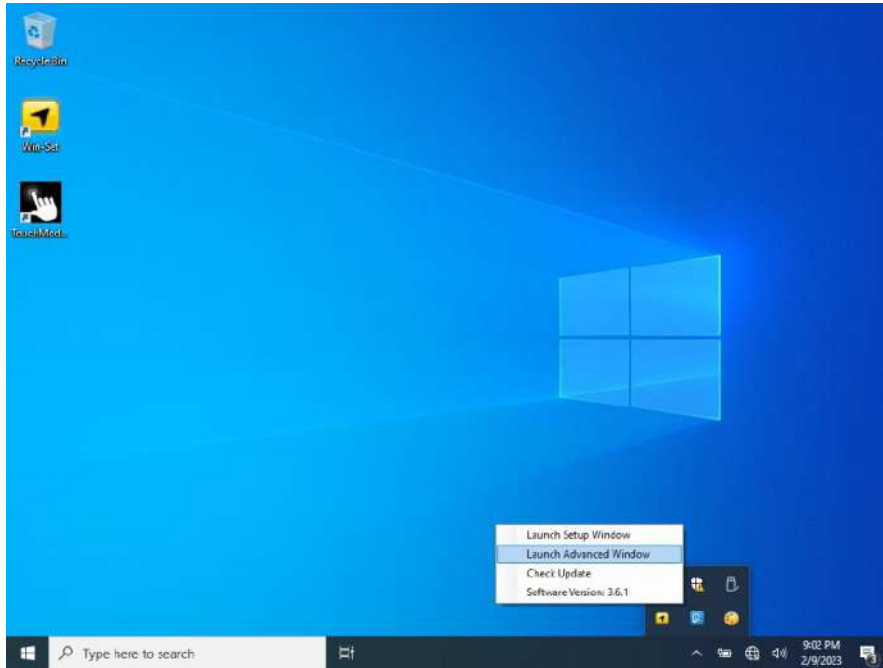

- DO: Set the DO status through win-set

When you press the  button, DO voltage is set to HIGH, and it will give 5V signal.

When you press the  button, DO voltage is set to LOW. (This is Default)

- DI: View DI status through Ignition Software AP

When DI shows LOW, the DI voltage is LOW. (This is Default)

When DI shows HIGH, DI voltage is HIGH. (High active 5~12V)

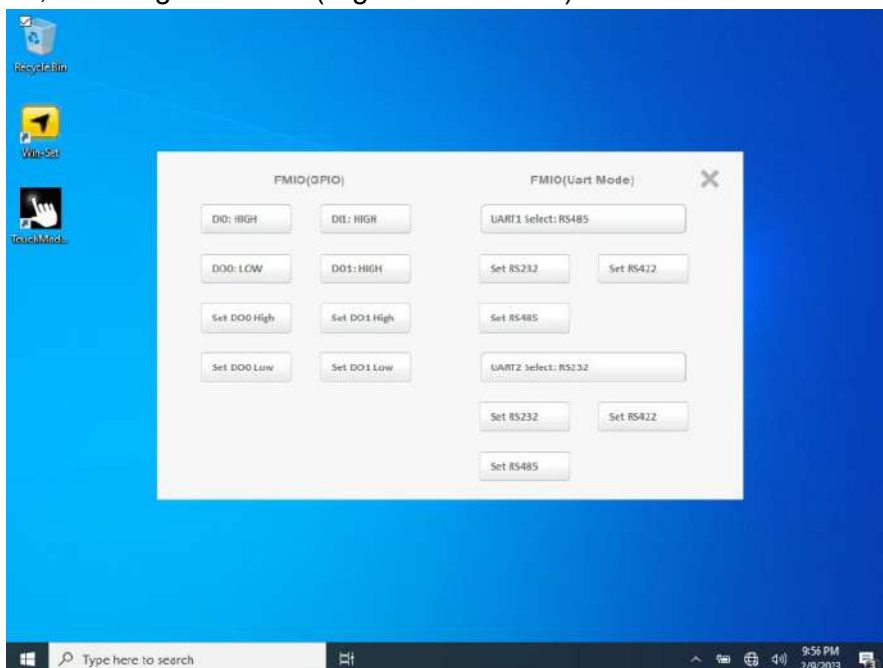

4.5.2 COM port Controller

Tap on the Ignition Software AP Icon and choose Launch Advanced Window. Then you can set COM1/COM2 to RS232, RS422, or RS485.

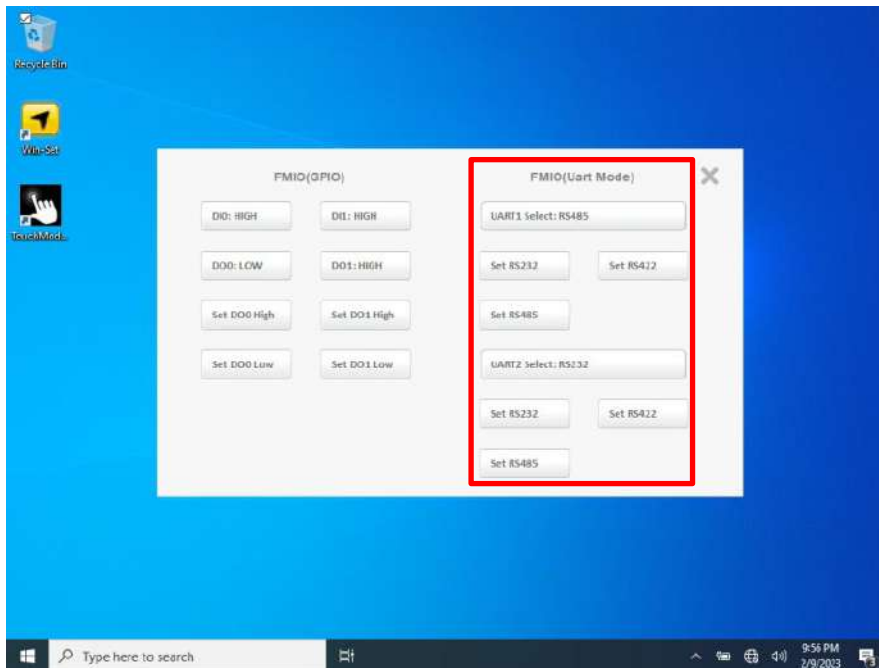

4.6 BT

Your device has integrated BT capabilities for short-range wireless communication between BT - enabled devices. You can transfer files, playback audio, configure virtual serial ports, and share network connection via Bluetooth.

By default, the BT feature is enabled as indicated by the BT icon on the taskbar. To Enable the Wireless BT feature, perform the following procedure:

1. Long press the F4 to launch the RF Power Control utility application.
2. Check the status of the Bluetooth Icon.
3. To turn the BT adapter on or off, tap BT. A check mark indicates the BT adapter is turned on.



4. Click the BT icon in the windows notification area, a contextual menu for BT is displayed.
5. To add a device, tap on Add a Bluetooth Device, Windows will search any BT device automatically.
6. Choose the BT device that user wants to connect and follow onscreen prompt to continue the pair procedure and use the BT device.

4.6.1 Opening My Bluetooth

Use **My Bluetooth** to pair and connect with Bluetooth devices. Perform one of the following to open **My Bluetooth**:

- Double-tap **My Bluetooth** desktop shortcut icon.
- Tap Start > All Programs > Bluetooth > My Bluetooth.

4.7 BT Barcode Reader Setup

For more information, please refer to the Bluetooth scanner manufacturer's documentation; it may be available on the manufacturer's web site.

This device supports several different types of barcode readers. This section describes the interaction and required configurations for a mobile Bluetooth barcode scanner.

Prerequisites

- This device is equipped with the BT hardware and software. An operating system upgrade may be required.
- The mobile BT barcode scanner battery is fully charged.
- This device is connected to AC or DC (vehicle) power.



Locate the barcode label, similar to the one shown above, attached on the side of this device. The label represents the BT address identifier for this device.

The mobile BT scanner requires this information before discovering, pairing, connecting or disconnecting process.

4.7.1 The VMC with Label

If this device has a BT address barcode label attached, follow these steps:

1. Scan the paired BT address barcode label using the BT mobile scanner.
2. If this is the first time the BT scanner has scanned the BT label on your device, the devices are automatically paired. The BT LED will blink to indicate the pairing process is successful.



NOTE:

If there is no beep or no LED flash from the BT barcode reader, this indicates this device and the scanner are currently paired.

4.7.2 The VMC without Label

If there is no BT address barcode label attached on this device, perform the following to create a unique Bluetooth address barcode for this device:

1. Locate this device BT address by entering my Bluetooth.
2. Create a BT address barcode label for this device. The format for the barcode label is as follows:
 - Barcode type must be Code 128.
 - FNC3 character followed by string Uppercase L, lowercase n, lowercase k, uppercase B and then the Bluetooth address (12 hex digits, no colons). For example, LnkB0400fd002031.
3. Create and print the label.
4. Scan the BT address barcode label with the BT barcode reader. The devices are paired. The BT barcode reader responds with a series of beeps and LED flashes.

4.7.3 Adding and Pairing a BT Device

Perform the following to pair your Tablet Computer with BT devices:

1. Make sure the BT adapter is on as indicated by the Bluetooth icon () in the taskbar.
2. Open My Bluetooth
3. Tap **Search for Devices**. The Tablet Computer will scan for BT devices within range.
4. Double tap the device you want to pair with

4.8 WLAN

By default, the wireless antenna is turned on. In case you need to turn the wireless antenna on or off, perform the following:

1. Long press F4 to launch the RF Power Control utility.
2. Check the status of the Wi-Fi Icon.
3. If the WLAN feature is disabled (unchecked), tap on the Wi-Fi icon to enable it.





4. Click the wireless network connection status icon in the Windows notification area. A list of available wireless networks is displayed.
5. Double-click a network to connect to it. Provide required authentication information if needed.
6. To check the connection status, observe wireless network connection status icon in the Windows notification area. The more bars the icon shows, the better the wireless LAN connection strength is.
7. Now wireless LAN connection is setup, try connection to the network with an internet browser such as Internet Explorer.

**NOTE:**

Note that user can also turn the wireless antenna on or off in Windows Mobility Center (Tap Start > Control Panel > Hardware and Sound > Windows Mobility Center).

4.8.1 Connecting to a Wireless network

Perform the following to connect to a wireless network:

1. Make sure that the wireless antenna is “on” (The WLAN LED indicator () is green and the Wireless network icon on the taskbar shows).
2. Tap the Wireless Network icon ().
3. In the list of available networks, tap a network.



4. Tap Connect.
5. If the network requires authentication, enter the security key or passphrase.

Personal information and files on your wireless network can sometimes be seen by people who pick up your network signal. This can lead to identity theft and other malicious acts. A network security key or passphrase can help protect your wireless network from this type of unauthorized access.

The Set Up a Network wizard will guide you through setting up a security key. Please refer to this following link for more detail on how to set up a security key for a wireless network

<http://windows.microsoft.com/en-us/windows/set-security-key-wireless-network#1TC=windows-7>

4.9 WWAN(Optional)

For vehicle computers equipped with wireless WAN (4G/LTE) card, to use the wireless WAN feature to connect to the network, perform the following procedure:

1. Long press F4 to launch the RF Power Control utility.
2. Tap on the Device button.
3. Check the status of the WWAN.
4. If the WWAN feature is disabled (unchecked), tap on the WWAN icon to enable it.



5. You can check the wireless WAN connection status through the wireless network connection status icon in the Windows notification area. The more bars encompassed, the better the signal is.



NOTE:

For the Windows 7 operating system, you also can check the Access Connections gauge, the Access Connections status icon, or the Access Connections wireless status icon in the Windows notification area.

Perform the following to connect to your 4G network:

1. Verify that WWAN Mode is enabled (this icon will turn into orange color), this verifies that your WWAN radio module is enabled.
2. Open the Skylight application (tap Start > All programs > Sierra Wireless > Skylight) or (tap Start > Desktop > Skylight).

The skylight application window opens and the  icon appears in the Windows notification area as following picture.



3. The application detects the SIM card and display network information on the Skylight main screen.
4. Tap connect to connect the 4G network, once connected the Skylight main screen displays the network connection information, such as signal strength, connection speed and bitrate transfer.







Item	Icon	Description
1		On/Off
		Signal Strength
		Network Type
2		History
		Skylight® GPS
		Settings
		Toolbar
3		Network Name
4		Data Transfer Rate
5		Home
6		Speed Graph
7		Menu
		Minimize
		Restore
		Close
8		Connect or Disconnect Button
9		Network Info
10		Speed
11		Customer Support

4.10 Using Camera Features

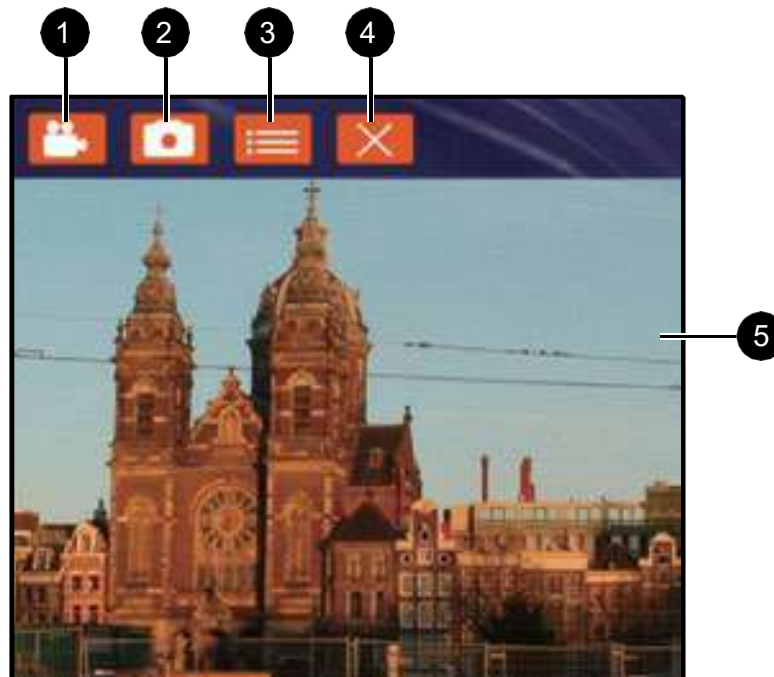
Your device has a built-in camera. This section explains how to use camera for taking pictures and making videos.

4.10.1 The Camera Screen





No	Item	Description
1	 Video	Tap to record videos
2	 Photo	Tap to capture photos
3	 Settings	Tap to select the destination folder to save captured photos and videos, enable preview, and select picture resolution and quality
4	 Close	Tap to close the camera
5	Capture Screen	Shows the object to capture

4.10.2 Shooting Photos

1. Open the Camera
2. Focus on the object
3. Tap  to capture the object
4. By default, the photo preview is displayed briefly on the screen



The preview screen automatically closes after 3 seconds. Alternatively, do one of the following:

- Tap  to delete the photo and return to the camera screen
- Tap  to close the preview and return to the camera screen

4.10.3 Recording Videos

1. Open the Camera.
2. Focus on the object
3. Tap  to record the video. The video recording screen appears



4. Tap  to stop recording and return to the camera screen
5. To playback the video, browse for the video file and play using a media player application on your device.

4.10.4 Camera Settings

1. Tap  to open the setting page.
2. Modify necessary settings.
3. When settings are complete, tap OK to apply and save change.

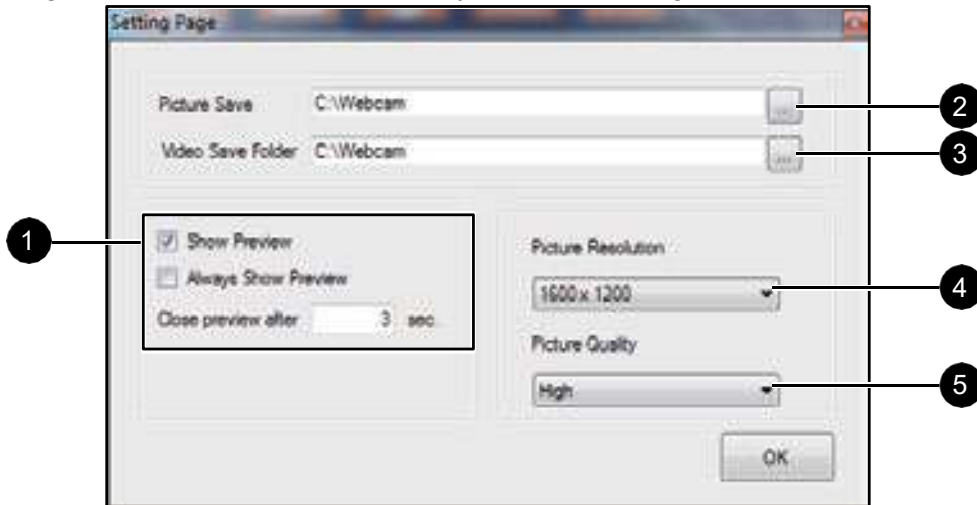

No	Item	Description
1	Preview Setting	<p>Check one of the check boxes to show the preview screen right after capturing a photo.</p> <p>Show Preview: Check this box and enter the preview duration on Close preview after. When the duration ends, the preview screen will automatically close.</p> <p>Always Show Preview: When this box is checked, the preview screen will only close when you tap the return ().</p>
2	Picture Save	Tap this button to browse for the folder directory where you want to save captured photos.
3	Video Save Folder	Tap this button to browse for the folder directory where you want to save recorded videos.
4	Picture Resolution	<p>Select the picture resolution:</p> <ul style="list-style-type: none"> • 640 x 480 • 1600 x 1200
5	Picture Quality	Select the picture quality: Low, Medium, High, Best .

4.11 Using Recovery Wizard to Restore Computer

The FM-VML Series computer has a dedicated recovery partition stored on the hard drive of the vehicle computer to enable quick one-key recovery process. This partition occupies about 11GB of the storage space, and comes built-in to each FM-VML Series vehicle computer.



IMPORTANT:

Before starting the recovery process, be sure to backup all user data, as all data will be lost after the recovery process.

Follow the procedure below to enable quick one-key recovery procedure:

1. Plug-in the AC adapter to FM-VML Series vehicle computer. Make sure the vehicle computer stays plugged in to power source during the recovery process.
2. Turn on the vehicle computer, and when the boot screen shows up, press the **F1** button (Recovery Key) on the front bezel OR press **F6** when using an external USB keyboard to initiate the Recovery Wizard.

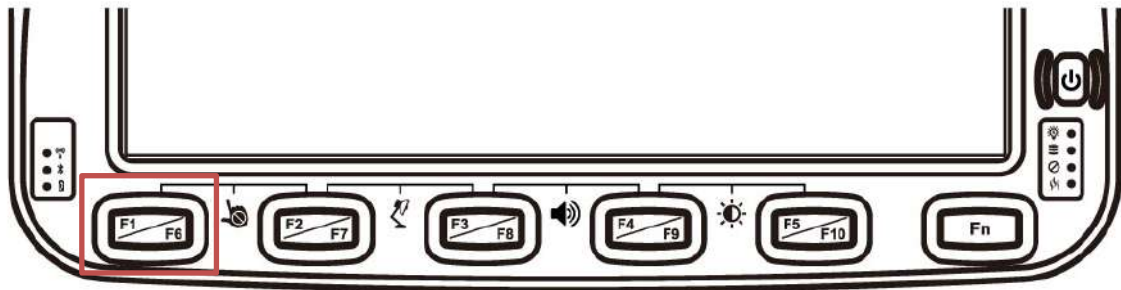

3. The following screen shows the Recovery Wizard. Click on "Recovery" button to continue.



4. A warning message about data loss will show up. Make sure data is backed up before recovery, and click on "Yes" to continue.



5. Wait till the recovery process to complete. During the recovery process, a command prompt will show up to indicate the percent of recovery process. After recovery is completed, and the vehicle computer will restart automatically.



Chapter 5: Accessories Installation

5.1 Installing a SIM Card

The Vehicle mounted computer supports data connection using 3G or 4G/LTE SIM cards and fits nano-SIM card. (Note: 4G/LTE feature is optional). Perform the following to install the SIM card to your vehicle mounted computer:

1. Remove the service window in the right side of the device by unscrewing two screws
2. Remove the screw that is securing the service window, carefully lift the cover up
3. Locate the SIM card slot and then insert it (the IC contact patch side of the SIM Card faces toward the front side of the device)
4. Make sure the SIM Card IC contact patch is facing the right direction (as shown in the picture below)

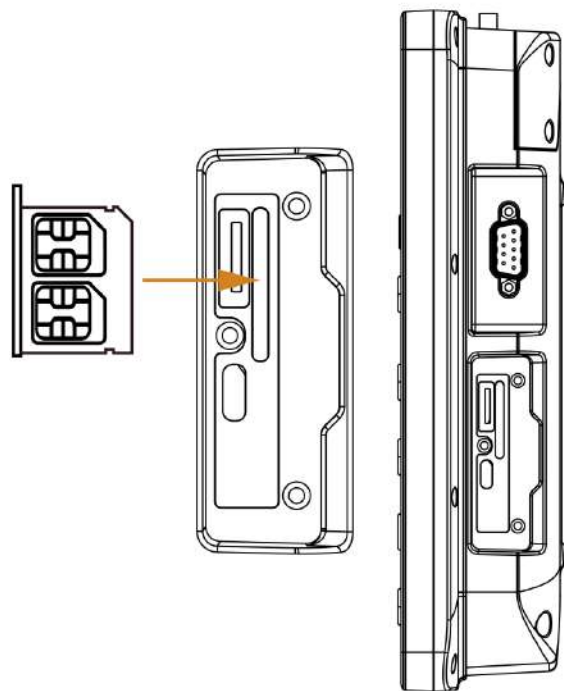

5.2 Installing a Micro SD Card

Micro SD card can be used to store files in the vehicle mounted computer, user can copy / download / upload files to and from the VMC. Perform the following to install the SIM card to your device.

1. Remove the service windows in right side of the device by unscrewing two screws.
2. Remove the screw that is securing the service window, carefully lift the cover up.
3. Locate the Micro SD Card slot and then insert it, the label side of the Micro SD card faces toward the back of the device.
4. Make sure the micro SD card is faced the right direction (as shown in the picture below).

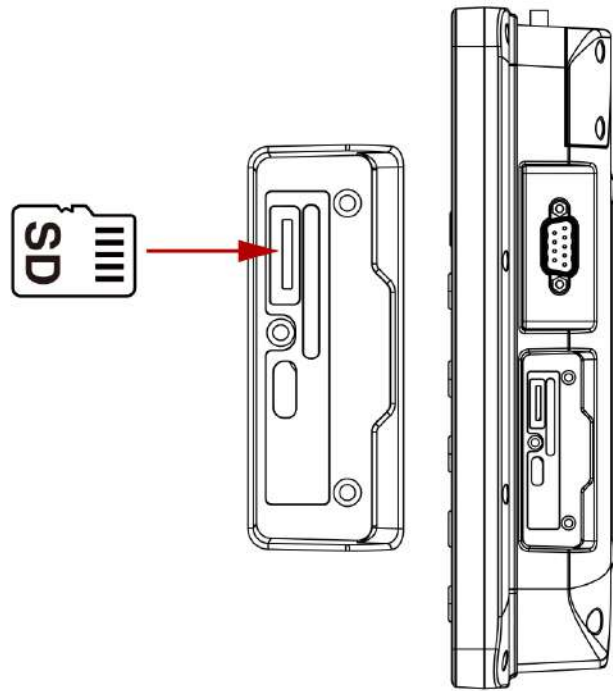

5. Reposition the removed service window and then screw to secure the service window.

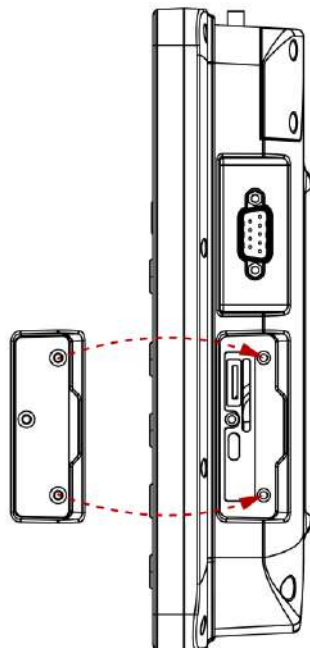

Chapter 6: Vehicle Mounting

6.1 Vehicle Mount Instruction

Make sure that the FM-VML Series VMC does not obstruct the driver's vision and ensures safe driving.

The general steps to mount the device on the vehicle are as follows:

1. Install RAM mount to the vehicle.
2. Place FM-VML Series VMC to the docking station.
3. Secure the keyboard (optional).
4. Adjust the viewing angle of the VMC.
5. Install antennas if necessary.
6. Connect peripheral devices and cables.
7. Connect vehicle power.
8. Secure all cables.

*Refer to "[RAM Mount Installation](#)" section of this User Manual for RAM mount and keyboard installation instructions.

6.2 RAM Mount Installation

Winmate recommends using RAM Mounting Parts as part of our device mounting solution. The rear cover of this device is designed to be mounted to RAM Mount solutions, which provides different mounting options to fit any industrial use or vehicle. Please notice that mounting kits are not included in the standard package.



Important:

The information below is just a guideline on how you should mount the Winmate device using RAM Mount. To purchase the RAM parts, please follow the RAM Mounts Part and purchase from your preferred retailer.

Mounting 1 – No Drill Solution

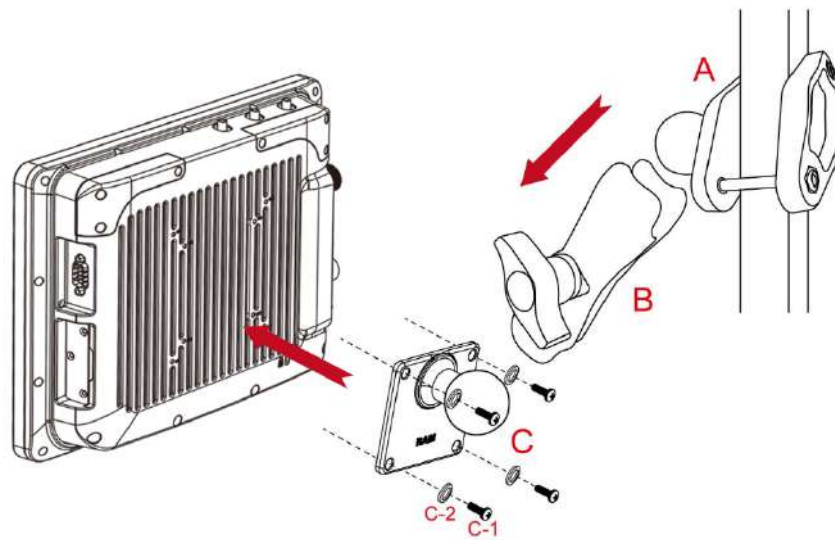

No	Component	RAM Mount Part Number	Description	QTY
A	RAM Clamp Mounts - on the forklift	RAM-D-247U-4	Clamp base with 2.25" Ball	1
B	RAM Arm	RAM-D-201U	Arm for 2.25" Ball(L:8.375")	1
C	RAM Ball on the device side	RAM-D-2461U	75x75mm VESA with 2.25" Ball	1
C-1	Screw	-	SUS304 M5 x 12mm Screw	5
C-2	Washer	-	M5 Washer	5

Mounting 2 – Drill Solution

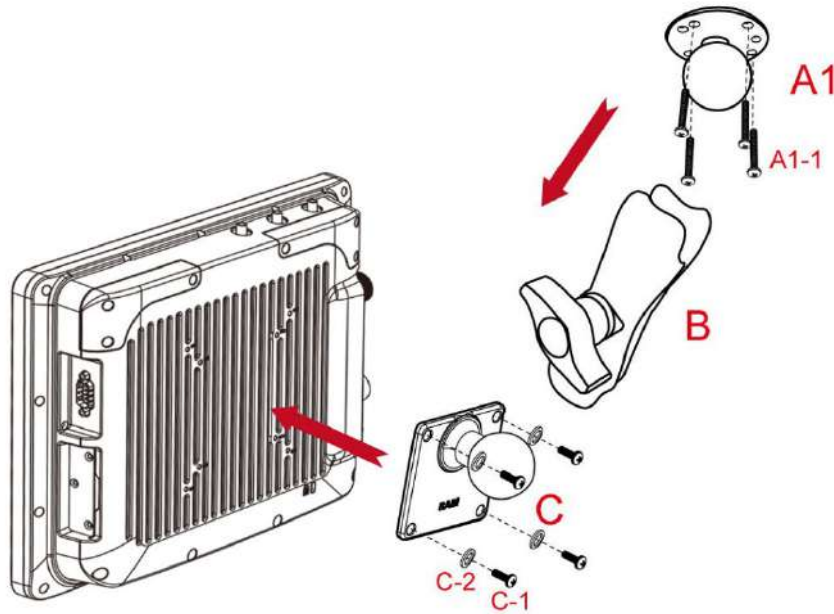

No	Component	RAM Mount Part Number	Description	QTY
A1	RAM round base mounts - on the forklift	RAM-D-202U	3.68" Round Base with 2.25" Ball	1
A1-1	Screw	-	SUS304 M8 x 40mm Screw	5
B	RAM Arm	RAM-D-201U	Arm for 2.25" Ball (Length:8.375")	1
C	RAM Ball on the device side	RAM-D-2461U	75x75mm VESA with 2.25" Ball	1
C-1	Screw	-	SUS304 M5 x 12mm Screw	5
C-2	Washer	-	M5 Washer	5

RAM Mount Assembly

Step 1 Install RAM Clamp to vehicle or forklift

1. Determine the position for mounting the RAM clamp mount according to RAM Mounts installation guide and specification.
2. Place the upper clamp with ball on the beam, insert the bolt.
3. Place the lower clamp below the beam. Align the bolts with the holes in the lower clamp.
4. Place the nuts and then tighten it.

Step 2 Install RAM Ball base to vehicle dashboard / other surface.

1. Please make sure that the surface is flat and rigid.
2. Attach the RAM ball base to the vehicle and fix it using bolt or fasteners.

Step 3 Attach RAM Mount Ball to the device.

1. Turn the device off before installing the RAM mount ball.
2. Locate the VESA mount holes on the back of the device and align it with the holes from RAM Ball base. Fix with four M5 screws.

Step 4 Attach the device to RAM arm.

1. Insert the RAM arm over the ball on the vehicle RAM mount (shown here).
2. Insert the ball on the dock into the RAM arm and tighten the knob.

Mounting 3 – Keyboard Mounting Installation

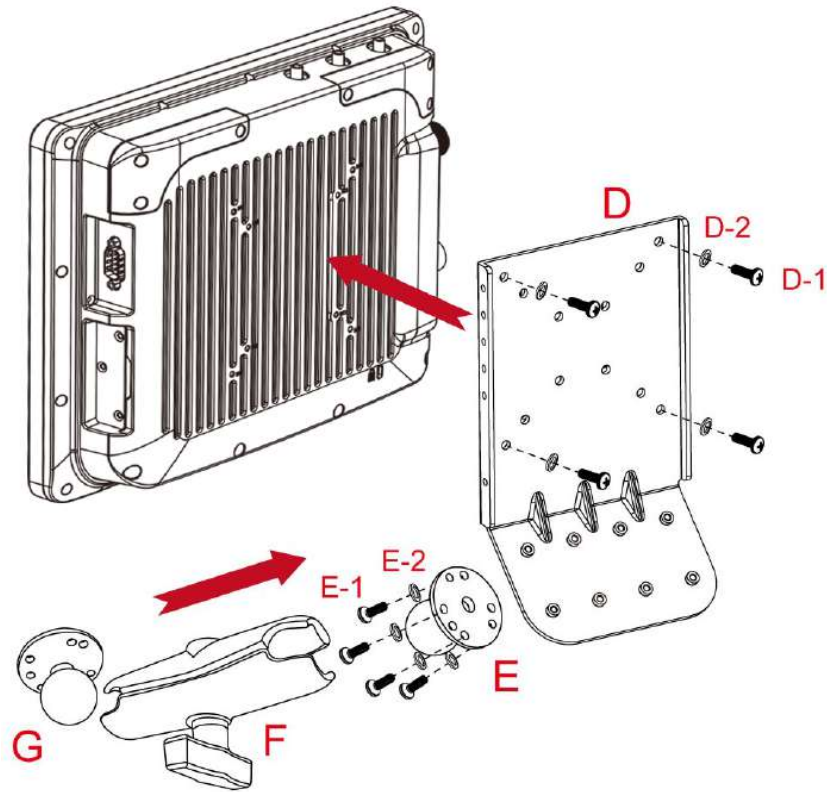

No	Component	RAM Mount Part Number	Description	QTY
D	Winmate Keyboard Adapter Plate (designed by Winmate)	-	4 VESA Holes on the plate to device and 4 AMPS holes to RAM Ball	1
D-1	Screw	-	SUS304 M5 x 20mm Screw	5
D-2	Washer	-	M5 WASHER	5
E	RAM Ball on the sloped part of the keyboard adapter plate	RAM-202U	2.5" Round Base with 1.5" Ball	1
E-1	Screw	-	SUS304 M4 x 14mm Screw	5
E-2	Washer	-	M4 WASHER	5
F	RAM Arm	RAM-201U	Arm for 1.5" Ball (Length:5.6")	1
G	RAM Ball on the sloped part of the keyboard adapter plate	RAM-202U	2.5" Round Base with 1.5" Ball	1

Keyboard Assembly

This part shows the steps to install the keyboard.

1. Fasten all four screws on the RAM mount ball on the back of the keyboard.
2. Fasten the keyboard adapter on the other end of the RAM mount ball.

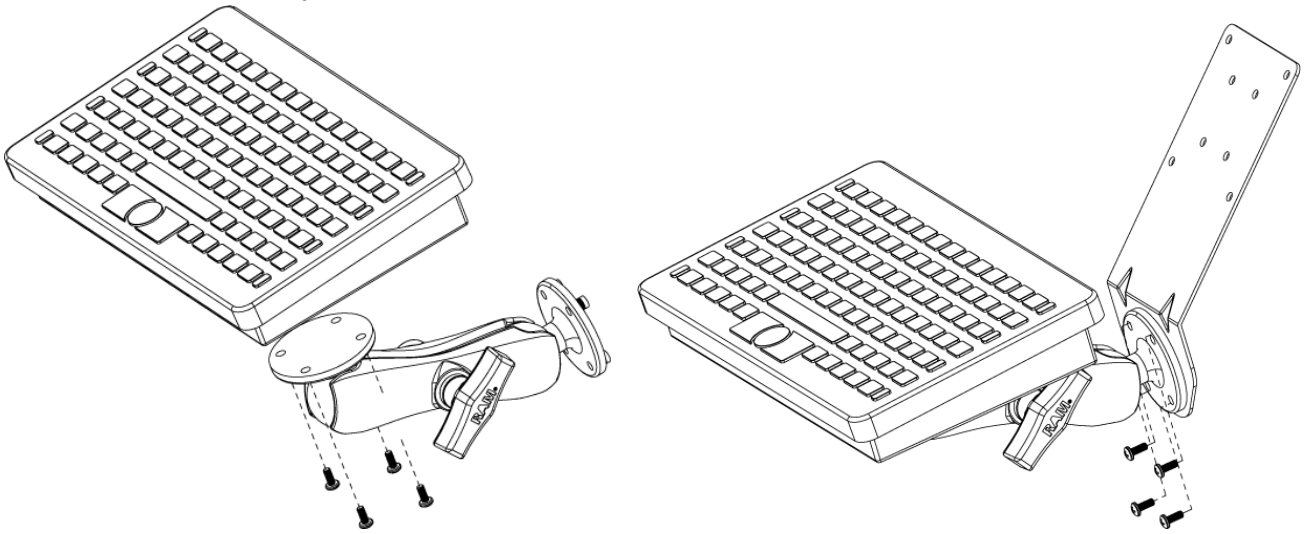

3. Fasten the RAM mount ball screws on the back of the device, so all mounting parts are fastening together.

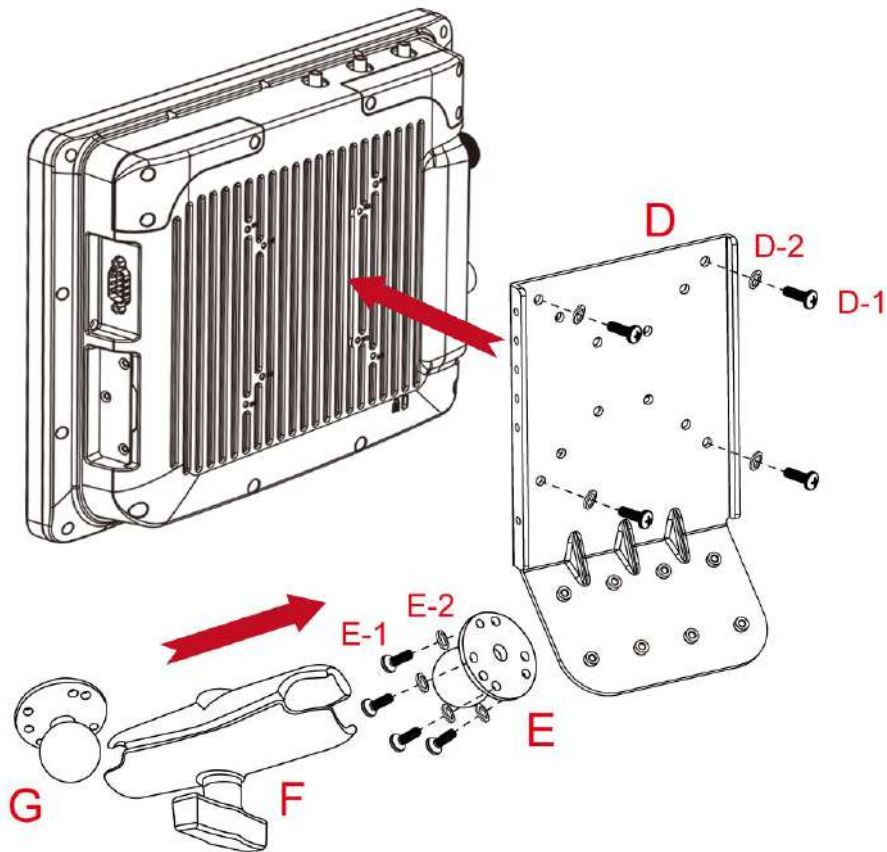

Appendix A: Technical Specifications

FM10E-VML

FM10E-VML	
System Specifications	
Processor	Intel Elkhart Lake x6425E Processor, 2.0 GHz
System Memory	4GB SODIMM DDR4-3200 (up to 8GB)
Storage	128GB M.2 SSD (up to 256 GB)
Operating System	Windows 10 IoT Enterprise
Security	TPM 2.0
Display Specifications	
Size / Technology	10.4"
Resolution	1024 x 768
Viewing Angle	88,88,88,88
Brightness	400 nits (up to 800 nits)
Touch	Projected Capacitive Multi Touch
Wireless Communications	
WLAN	Support
BT	Support
GPS	GPS/GLONASS(Optional)
WWAN	4G/LTE (Optional)
Data Capture	
Camera	2MP Camera at front side
Mechanical Specifications	
Dimensions (W x L x H)	268 x 214 x 51 mm
Housing	Magnesium Alloy housing with fanless design
Weight	2.4kg
Environment Considerations	
Operating Temperature	-30°C to 50°C
Storage Temperature	-30°C to 60°C (-22° to 140°F)
Humidity	5% to 90% RH, non-condensing
IP Proof	IP65
Impact	Support EN62262 IK07 rating
Shock	MIL-STD-810H Method 516.8 Procedure I
Vibration	MIL-STD-810H Method 516.8 Procedure I
ESD	Compliant with EN 6100042, enhanced ESD to ±12kV direct & ±15kV air.
Standards and Certifications	
Certification	CE, FCC, UL609501, EN609501, PTCRB, FCC (Electromagnetic Emissions), IC (ICES003)
I/O Connectors	
IO Port	1 x USB Type-C 1 x USB 2.0 Type-A

FM10E-VML

	1 x Micro SD Card Slot 6 x LED Indicator (WiFi, BT, UPS battery, HDD, Screen Blanking, Heater) 1 x Dual nano-SIM Card Slot 1 x CANBus(optional) 2 x RS232/422/485(Default RS232) 1 x Audio(Mic in or Line Out) either one with DIDO (Optional) 1 x Gigabit LAN port PSE (IEEE 802.3at 30W) (Optional) 1 x DIDO(2XDI;2XDO) either one with Audio(Optional)
Power Management	
Power Input	9V~36V with ignition control
UPS Battery	400mAh UPS Battery for 20 minutes backup (Optional)

FM12E-VML**FM12E-VML**

System Specifications	
Processor	Intel Elkhart Lake x6425E Processor, 2.0 GHz
System Memory	4GB SODIMM DDR4-3200 (up to 8GB)
Storage	128GB M.2 SSD (up to 256 GB)
Operating System	Windows 10 IoT Enterprise
Security	TPM 2.0
Display Specifications	
Size / Technology	12.1"
Resolution	1024 x 768
Viewing Angle	89,89,89,89
Brightness	400 nits (up to 800 nits)
Touch	Projected Capacitive Multi Touch
Wireless Communications	
WLAN	Support
BT	Support
GPS	GPS/GLONASS(Optional)
WWAN	4G/LTE (Optional)
Data Capture	
Camera	2MP Camera at front side
Mechanical Specifications	
Dimensions (W x L x H)	306 x 225 x 56 mm
Housing	Magnesium Alloy housing with fanless design
Weight	2.4kg
Environment Considerations	
Operating Temperature	-30°C to 50°C
Storage Temperature	-30°C to 60°C (-22° to 140°F)

FM12E-VML	
Humidity	5% to 90% RH, non-condensing
IP Proof	IP65
Impact	Support EN62262 IK07 rating
Shock	MIL-STD-810H Method 516.8 Procedure I
Vibration	MIL-STD-810H Method 516.8 Procedure I
ESD	Compliant with EN 6100042, enhanced ESD to ±12kV direct & ±15kV air.
Standards and Certifications	
Certification	CE, FCC, UL609501, EN609501, PTCRB, FCC (Electromagnetic Emissions), IC (ICES003)
I/O Connectors	
IO Port	<ul style="list-style-type: none"> 1 x USB Type-C 1 x USB 2.0 Type-A 1 x Micro SD Card Slot 4 x LED Indicator (WLAN, UPS battery, HDD, Heater) 1 x Dual nano-SIM Card Slot 1 x CANBus(optional) 2 x RS232/422/485(Default RS232) 1 x Audio(Mic in or Line Out) either one with DIDO (Optional) 1 x Gigabit LAN port PSE (IEEE 802.3at 30W) (Optional) 1 x DIDO(2XDI;2XDO) either one with Audio(Optional)
Power Management	
Power Input	9V~36V with ignition control
UPS Battery	400mAh UPS Battery for 20 minutes backup (Optional)

FM14E-VML

FM14E-VML	
System Specifications	
Processor	Intel Atom ® x6425E(1.5M Cache ,up to 3.00 GHz)
System Memory	4GB SODIMM DDR4-3200 (up to 8GB)
Storage	128GB M.2 SSD (up to 256 GB)
Operating System	Windows 10 IoT Enterprise
Security	TPM 2.0
Display Specifications	
Size / Technology	14"
Resolution	1920 x 1080
Viewing Angle	85,85,85,85
Brightness	700 nits
Touch	Projected Capacitive Multi Touch
Wireless Communications	
WLAN	Support
BT	Support

FM14E-VML	
GPS	GPS/GLONASS(Optional)
WWAN	4G/LTE (Optional)
Data Capture	
Camera	2MP Camera at front side
Mechanical Specifications	
Dimensions (W x L x H)	342 x 225 x 52 mm
Housing	Magnesium Alloy housing with fanless design
Weight	2.5kg
Environment Considerations	
Operating Temperature	-30°C to 50°C
Storage Temperature	-30°C to 60°C (-22° to 140°F)
Humidity	5% to 90% RH, non-condensing
IP Proof	IP65
Impact	Support EN62262 IK07 rating
Shock	MIL-STD-810H Method 516.8 Procedure I
Vibration	MIL-STD-810H Method 514.8 Procedure I
ESD	Compliant with EN 6100042, enhanced ESD to ±12kV direct & ±15kV air.
Standards and Certifications	
Certification	CE, FCC, UL609501, EN609501, PTCRB, FCC (Electromagnetic Emissions), IC (ICES003)
I/O Connectors	
IO Port	1 x USB 3.0 Type-C (OTG) 1 x USB 2.0 Type-A 1 x Micro SD Card Slot 4 x LED Indicator 1 x Dual nano-SIM Card Slot 1 x CANBus(optional) 2 x RS232/422/485(Default RS232) 1 x Audio(Mic in or Line Out) either one with DIDO (Optional) 1 x Gigabit LAN port PSE (IEEE 802.3at 30W) (Optional) 1 x DIDO(2XDI;2XDO) either one with Audio(Optional)
Power Management	
Power Input	9V~36V with ignition control
UPS Battery	400mAh UPS Battery for 20 minutes backup (Optional)

NOTE:

1. Total usable memory will be less dependent upon actual system configuration.
2. SOTI is available upon request.
3. Length measurements do not include protrusions. Weight varies with options.
4. Measured at dimming LCD brightness. Varies depending on the usage conditions, or when an external device is attached.
5. Accessories may vary depending on your configuration.
6. This is a simplified drawing and some components are not marked in detail.
7. The product shown in this datasheet is a standard model. For diagrams that contain customized or optional I/O, please contact the Winmate Sales Team for more information.



Winmate Inc.
9F, No.111-6, Shing-De Rd., San-Chung District,
New Taipei City 24158, Taiwan, R.O.C
www.winmate.com

