

SI-636
Digital Signage Player with
13th/12th Gen Intel® Core™
Processor

User's Manual

Version 1.0
(July 2025)



Copyright

© 2025 IBASE Technology, Inc. All rights reserved.

No part of this publication may be reproduced, copied, stored in a retrieval system, translated into any language, or transmitted in any form or by any means—electronic, mechanical, photocopying, or otherwise—without the prior written consent of IBASE Technology, Inc. (hereinafter referred to as “IBASE”).

Disclaimer

IBASE reserves the right to make changes and improvements to the products described in this document without prior notice. Every effort has been made to ensure that the information in this document is accurate; however, IBASE does not guarantee that the document is error-free. IBASE assumes no liability for incidental or consequential damages arising from the misuse of, or inability to use, the product or the information contained herein, nor for any infringements of third-party rights that may result from its use.

Trademarks

All trademarks, registered trademarks, and brand names mentioned herein are used for identification purposes only and may be the property of their respective owners.

Compliance

CE

This product has passed CE tests for environmental specifications and limits. This product is in accordance with the directives of the European Union (EU). If users modify and/or install other devices in this equipment, the CE conformity declaration may no longer apply.

FCC

This product has been tested and found to comply with the limits for a Class B device, pursuant to Part 15 of the FCC Rules. These limits are designed to provide reasonable protection against harmful interference in a residential installation. This equipment generates, uses and can radiate radio frequency energy and, if not installed and used in accordance with manufacturer's instructions, may cause harmful interference to radio communications.

WEEE



This product must not be disposed of as normal household waste, in accordance with the EU directive for waste electrical and electronic equipment (WEEE - 2012/19/EU). Instead, it should be disposed of by returning it to a municipal recycling collection point. Check local regulations for disposal of electronic products.

Green IBASE



This product is compliant with the current RoHS 2 restrictions and prohibits use of the following substances in concentrations exceeding 0.1% by weight (1000 ppm) except for cadmium, limited to 0.01% by weight (100 ppm).

- Hexavalent chromium: 1,000 ppm
- Poly-brominated biphenyls (PBBs): 1,000 ppm
- Poly-brominated diphenyl ethers (PBDEs): 1,000 ppm
- Cadmium: 100 ppm
- Mercury: 1,000 ppm
- Lead: 1,000 ppm
- Bis(2-ethylhexyl) phthalate (DEHP): 1,000 ppm
- Butyl benzyl phthalate (BBP): 1,000 ppm
- Dibutyl phthalate (DBP): 1,000 ppm
- Diisobutyl phthalate (DIBP): 1,000 ppm

Important Safety Information

Carefully read the precautions before using the device.

Environmental conditions:

- Lay the device horizontally on a stable and solid surface in case the device may fall, causing serious damage.
- Leave plenty of space around the device and do not block the openings for ventilation. Never drop or insert any objects into the ventilation openings.
- Slots and openings on the chassis are for ventilation. Do not block or cover these openings. Make sure you leave plenty of space around the device for ventilation. Never insert objects of any kind into the ventilation openings.

Care for your iBASE products:

- Before cleaning the device, turn it off and unplug all cables such as power as residual current may still be present.
- Use neutral cleaning agents or diluted alcohol to clean the device chassis with a cloth. Then wipe the chassis with a dry cloth.
- Vacuum the dust with a computer vacuum cleaner to prevent the air vent or slots from being clogged.



WARNING

Attention during use:

- Do not use this product near water.
- Do not spill water or any other liquids on your device.
- Do not place heavy objects on the top of the device.
- Operate this device from the type of power indicated on the marking label. If you are not sure of the type of power available, consult your distributor or local power company.
- Do not walk on the power cord or allow anything to rest on it.
- If you use an extension cord, make sure that the total ampere rating of the product plugged into the extension cord does not exceed its limits.

Avoid Disassembly

You are not suggested to disassemble, repair or make any modification to the device. Disassembly, modification, or attempted repairs may pose safety hazards and cause damage to the device, or even result in injury or property damage, and will void any warranty.



CAUTION

Danger of explosion if internal lithium-ion battery is replaced by an incorrect type. Replace only with the same or equivalent type recommended by the manufacturer. Dispose of used batteries according to the manufacturer's instructions.

Warranty Policy

- **IBASE standard products:**

24-month (2-year) warranty from the date of shipment. If the date of shipment cannot be ascertained, the product serial numbers can be used to determine the approximate shipping date.

- **3rd-party parts:**

12-month (1-year) warranty from delivery for the 3rd-party parts that are not manufactured by IBASE, such as CPU, memory, SSD/HDD, power adapter, panel and touchscreen.

* *Products that fail due to misuse, accident, improper installation or unauthorized repair shall be treated as out of warranty and customers shall be billed for repair and shipping charges.*

Technical Support & Services

1. Visit the IBASE website at www.ibase.com.tw to find the latest information about the product.
2. If you need any further assistance from your distributor or sales representative, prepare the following information of your product and elaborate upon the problem.
 - Product model name
 - Product serial number
 - Detailed description of the problem
 - The error messages in text or in screenshots if there is any
 - The arrangement of the peripherals
 - Software in use (such as OS and application software, including the version numbers)
3. If repair service is required, you can download the RMA form at the website of IBASE. Fill out the form and contact your distributor or sales representative.

Table of Contents

Chapter 1	General Information	1
1.1	Introduction	2
1.2	Features	2
1.3	Packing List	3
1.4	Optional Accessories	3
1.5	Specifications	4
1.6	I/O View	6
1.7	Dimensions	7
Chapter 2	Hardware Installation & Motherboard Information	8
2.1	Installations	9
2.1.1	Memory Installation / Replacement	9
2.1.2	M.2 Cards Installation	10
2.1.3	WiFi / 4G / 5G Antenna Installation	10
2.1.4	Mounting Installation	11
2.1.5	Pin Assignment for Power Input Connector	12
2.1.6	Pin Assignment for COM1 & COM2 Serial Ports	12
2.2	Setting the Jumpers	14
2.3	Jumper & Connector Locations on Motherboard	15
2.4	22Jumper & Connectors Quick Reference	16
2.4.1	JP1: Clear ME Contents	17
2.4.2	JP2: Clear CMOS Data	17
2.4.3	JP4: Iash Descriptor Security Override	17
2.4.4	JP5: Sierra EM9191 5G Card USB/PCIe Select	18
2.4.5	JP6: ATX / AT Power Mode Select	18
2.4.6	CN8: DC Power Input	19
2.4.7	CN9 / CN10 / CN11 / CN12 / CN13 / CN14: HDMI Ports	19
2.4.8	CN15: USB Type C Connector	20
2.4.9	CN16 / CN17 / CN18: USB 3.2 Ports	20
2.4.10	CN19: Audio Line-in	21
2.4.11	CN20: Audio Line-out	21
2.4.12	SW1: OOB Scheduled for Power on/off	22
2.4.13	SW2: OOB Booting	22
2.4.14	SW3: ATX Power ON Switch	23
2.4.15	J22: ATX Power ON Connector	23
2.4.16	CN6: Gigabit LAN Port	24
2.4.17	CN5: 2.5 Gigabit LAN Port	24

2.4.18	CN7: Micro USB Connector For OOB FW Upgrade.....	25
2.4.19	CN3: COM2 RS-232 Connector; CN4: COM1 RS-232/422/485 ..	25
2.4.20	CN1: SIM Slot.....	26
2.4.21	J1: Battery Connector	26
2.4.22	J2: SPI Flash Connector	27
2.4.23	J4: M.2 E-Key Slot.....	27
2.4.24	J5 / J6: DDR5 SO-DIMM socket	28
2.4.25	J8: M.2 B-Key 3052 Slot.....	28
2.4.26	J11: J9: M.2 (M-Key) 2280 Slot	29
2.4.27	J20: Front Panel Settings Connector	30
2.4.28	CPU_FAN1: CPU Fan Power Connector	31
2.4.29	SYS_FAN1, SYS_FAN2: System Fan Power Connectors	31
2.4.30	SYS_FAN3: System Fan Power Connector	32
Chapter 3 Driver Installation		33
3.1	Introduction	34
3.2	Intel® Chipset Software Installation Utility	34
3.3	Intel® Graphics Driver Installation	36
3.4	HD Audio Driver Installation	38
3.5	LAN Driver Installation	39
3.6	Intel® Management Engine Components Drivers Installation.....	40
Chapter 4 BIOS Setup.....		41
Appendix		61
A.	I/O Port Address Map.....	62
B.	Interrupt Request Lines (IRQ)	64
C.	Watchdog Timer Configuration.....	65
D.	USB Power Control Bit.....	69

Chapter 1

General Information

The information provided in this chapter includes:

- Features
- Packing List
- Specifications
- Optional Accessories
- I/O View
- Dimensions

1.1 Introduction

The iBASE SI-636 is a slim, high-performance digital signage player powered by 13th/12th Gen Intel Core processors and AMD Radeon E8860 graphics with 2GB GDDR5, supporting up to 64GB DDR5-5600 SO-DIMM and six HDMI 1.4 outputs with independent audio for flexible video wall configurations. It features iSMART 4.0 energy-saving and Observer remote monitoring technologies, robust connectivity with M.2 B-Key for 5G/LTE, M.2 E-Key for Wi-Fi/Bluetooth, M.2 M-Key for storage, and two RS232 serial ports, all within a segregated flow ventilation design for reliable operation.



1.2 Features

- iSMART 4.0 smart control energy-saving technology
- Observer remote monitoring technology
- Supports 13th/12th Gen Intel® Core™ Processors
- Discrete AMD Radeon™ E8860 graphics processors with 2GB GDDR5
- 2x DDR5-5600 SO-DIMM, dual channel, Max. 64GB
- Flexible video wall display configuration
- 1x M.2 B-Key (3052) for 5G or LTE options
- 1x M.2 E-Key (2230) for Wi-Fi, Bluetooth
- 1x M.2 M-Key (2280) for storage
- 2x RS232 serial ports
- 6x HDMI 1.4 outputs with independent audio
- Slim and segregated flow ventilation design

1.3 Packing List

If you purchase a barebone SI-636, the product package includes the following. If any of the items below is missing, contact the distributor or the dealer from whom you have purchased the product.

The drivers and this user manual can be downloaded from our website.

- SI-636 Digital Signage Player x 1
- Power Adaptor x 1
- Power Cord x 1

1.4 Optional Accessories

IBASE provides optional accessories as listed below. Please contact us or your dealer if you would like to order any item(s).

- VESA Kit (includes):
 - Mounting Bracket x 1
 - Round Head Screw (M6 x 35 mm) x 4
 - Pan Head Screw (M4 x 8 mm) x 4

1.5 Specifications

Product	SI-636
System	
Mainboard	MBD636
CPU	13th/12th Gen Intel® Core™ Mobile Processors Max TDP: 35W
Chipset	SoC Integrated
Memory	2x DDR5-5600 SO-DIMM, dual channel
Graphics	AMD Radeon™ E8860 Graphics
LAN	1x Intel® I226LM 2.5Gb with LAN Wakeup and PXE support 1x Intel® I210AT (for OOB function with COM)
Expansion Slots	1x M.2 E-Key (2230) (WiFi-6E support) 1x M.2 B-Key (3052) (1x PCI-E x1; USB 2.0, USB 3.x) 1x UIM/SIM card slot 1x M.2 M-Key (2280) (for capture card) 1x M.2 M-Key (2280) NVMe (PCIe3.0 x4 / SATA)
I/O Interface	6x HDMI 1.4b 3x USB 3.2 1x USB type-C 1x Audio connector for Line-out/Line-in 1x Power / HDD LED 1x Power button 1x Power jack connector
Power Requirement	12V DC-in
Construction	Aluminum + SGCC
Weight	2kg(4.4 lbs)
Chassis Color	Black and white
Storage	1x M.2 (2280)
Power Supply	150W power adaptor
Mounting	Standard system bracket
Dimensions	290mm(W) x 222mm(D) x 29.9mm(H) 11.41"(W) x 8.74"(D) x 1.17"(H)
Operating System	Windows 10 (64-bit), Ubuntu (Installation)
Certification	CE, FCC Class-A, cULus

Environment	
Temperature	<ul style="list-style-type: none">• Operating: 0°C ~ 45°C (32°F ~ 113°F)• Storage: -20°C ~ 80°C (-4°F ~ 176°F)
Relative Humidity	5 ~ 90% at 45°C (non-condensing)
Vibration	1 grms / 5~500Hz / random operation

All specifications are subject to change without prior notice.

Note: The product performance relies on the system functioning as a whole. The level of CPU/APU/GPU processor, the interaction among the processor and the memory and storage bandwidth, or the functionality of the digital signage application software may affect the product performance.

1.6 I/O View

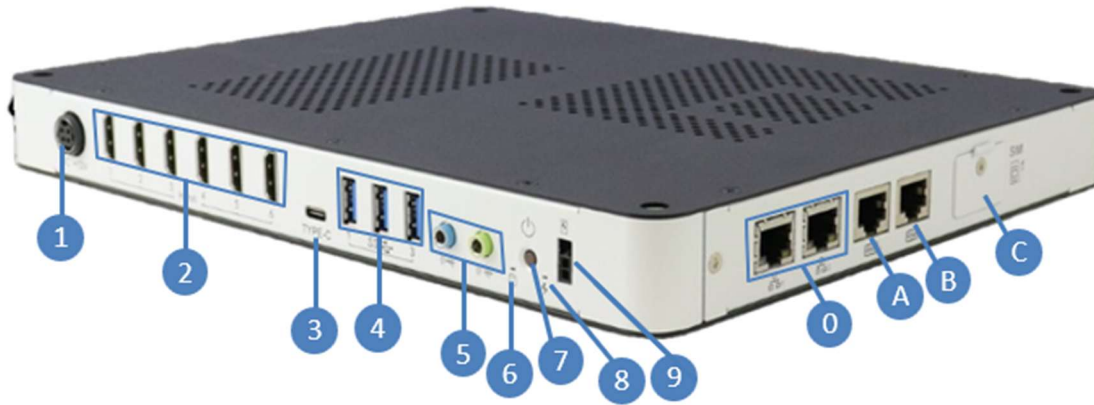

No.	Name	No.	Name
1	DC Power Input	7	Power Button
2	6x HDMI Ports	8	LED Indicator for Power
3	USB Type-C	9	For external power switch
4	3x USB 3.2 Ports	0	LAN Ports
5	Audio Jacks (from left to right: Line-Out, Line-In)	A	COM1 RS-232/422/485 Port
6	LED Indicator for HDD	B	COM2 RS-232 Port
		C	SIM card slot

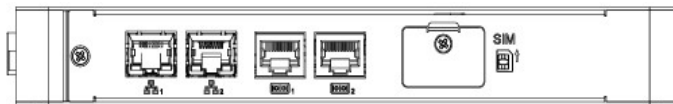
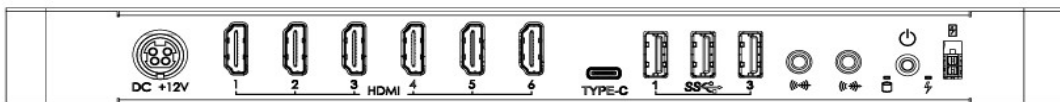

Chapter 2

Hardware Installation & Motherboard Information

This section contains general information about:

- Installations
- Jumper and connectors

2.1 Installations

Before installing any card or module into the device, remove the 10 screws shown in the picture below to remove the cover.

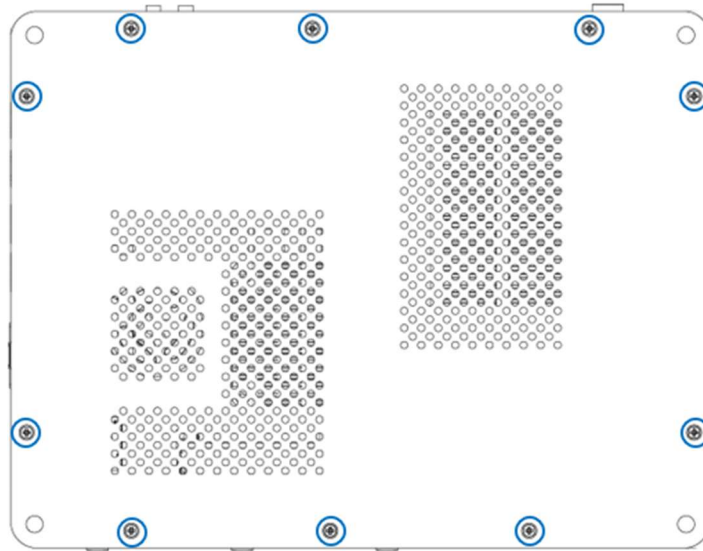

2.1.1 Memory Installation / Replacement

To install or replace modules, locate the memory slot on the board and perform the following steps:

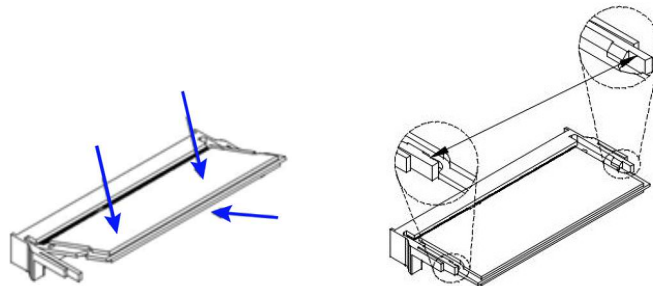

1. Align the key of the memory module with that on the memory slot and insert the module slantwise.
2. Gently push the module in an upright position until the clips click into place when the module is fully seated in the slot.

To remove a module, use your fingers to press the clips outwards until the module pops up. Grab the module gently and pull it out of the slot.

2.1.2 M.2 Cards Installation

1. Align the M.2 card's bus connector with the M.2 card slot, and insert the card slantwise.

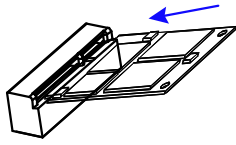

2. Push the card downwards as shown in the picture, and fix it with a screw.

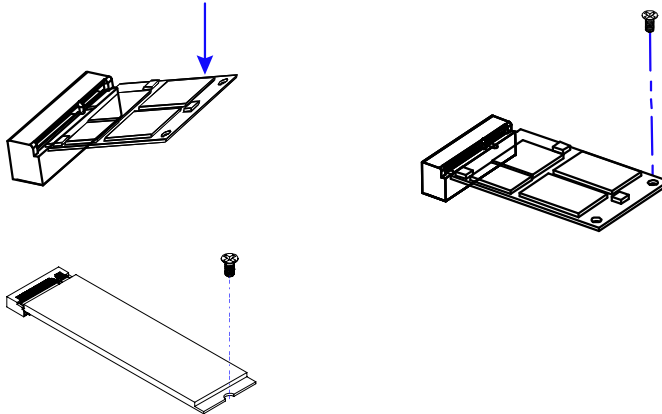

2.1.3 WiFi / 4G / 5G Antenna Installation

Insert the antenna extension cable through the antenna hole of the front I/O cover and fasten the antenna as shown below, then apply adhesive around the hex nut on the back of the front I/O cover to prevent the extension cable from loosening and falling off.

1. Fasten the hex nut and the washer. Then install the antenna.
2. Apply adhesive around here.



Info: The diameter of the nut is around 6.35 mm (0.25"-36UNC).

2.1.4 Mounting Installation

Note: Mounting plate is optional and purchasable from IBASE.

Requirements

Before mounting the system, ensure that you have enough room for the power adaptor and signal cable routing, and have good ventilation for the power adaptor. The method of mounting must be able to support the weight of the device plus the weight of the suspended cables attached to it.

The device with the optional mounting plate is shown as the figure below. Prepare at least 4 screws (M3) to install the device on the wall.

- VESA 75 x 75 mm
- VESA 100 x 100mm
- Wall Mount / TV Mount: 200 x 100 mm

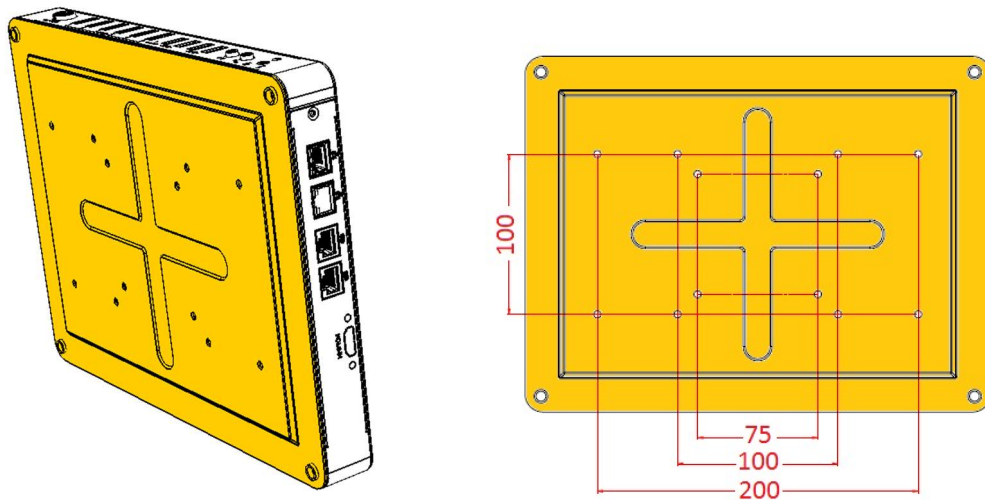

2.1.5 Pin Assignment for Power Input Connector

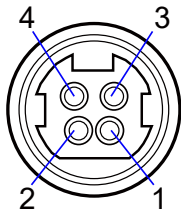

Pin	Signal	Pin	Signal
1	Ground	3	+12V
2	Ground	4	+12V

2.1.6 Pin Assignment for COM1 & COM2 Serial Ports



COM1 RS-232/422/485 port:

Pin	Signal Name		
	RS-232	RS-422	RS-485
1	DSR	NC	NC
2	Ground	Ground	Ground
3	Ground	Ground	Ground
4	TX	RX+	NC
5	RX	TX+	DATA+
6	DCD	TX-	DATA-
7	DTR	RX-	NC
8	CTS	NC	NC
9	RTS	NC	NC
10	RI	NC	NC

COM2 RS-232 port:

Pin	Signal Name	Pin	Signal Name
1	DSR (Data set ready)	6	DCD (Data carrier detect)
2	Ground	7	DTR (Data terminal ready)
3	Ground	8	CTS (Clear to send)
4	TX (Transmit)	9	RTS (Request to send)
5	RX (Receive)	10	RI (Ring indicator)

2.2 Setting the Jumpers

Use jumpers to enable features as needed for your application. Contact your supplier if you have doubts about the best configuration for your use.

Jumpers are small sets of metal pins mounted on the circuit board. Jumper caps are placed on pins to enable a feature or removed to disable it. When a 3-pin jumper is present, you can short either pins 1–2 or pins 2–3 to select a function. Leaving all pins open disables the function.

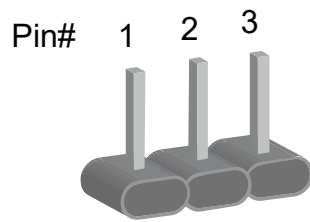

A 3-pin jumper

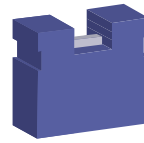

A jumper cap

Refer to the illustration below to set jumpers.

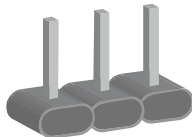
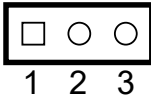
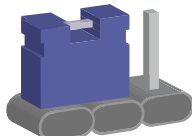
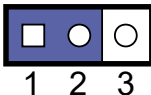
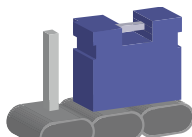
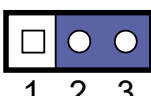
Pin closed	Oblique view	Illustration
Open		 1 2 3
1-2		 1 2 3
2-3		 1 2 3

When two pins are covered by a jumper cap, the jumper is considered closed (On). When a jumper cap is removed from two jumper pins, this jumper is **open**, i.e. turned **Off**.

2.3 Jumper & Connector Locations on Motherboard

Motherboard: MBD636

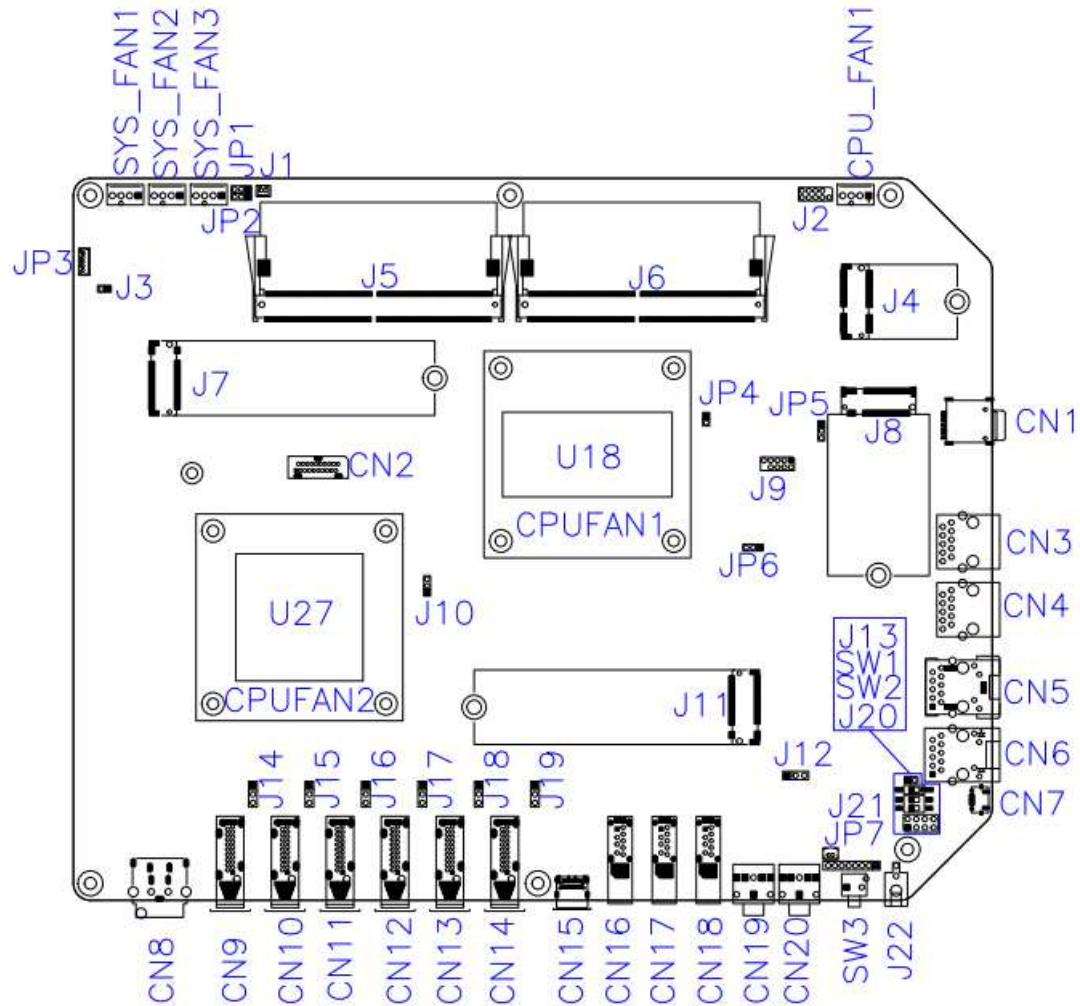

2.4 Jumper & Connectors Quick Reference

- 2.4.1 JP1: Clear ME Contents
- 2.4.2 JP2: Clear CMOS Data
- 2.4.3 JP4: Iash Descriptor Security Override
- 2.4.4 JP5: Sierra EM9191 5G Card USB/PCIe Select
- 2.4.5 JP6: ATX / AT Power Mode Select
- 2.4.6 CN8: DC Power Input
- 2.4.7 CN9 / CN10 / CN11 / CN12 / CN13 / CN14: HDMI Ports
- 2.4.8 CN15: USB Type C Connector
- 2.4.9 CN16 / CN17 / CN18: USB 3.2 Ports
- 2.4.10 CN19: Audio Line-in
- 2.4.11 CN20: Audio Line-out
- 2.4.12 SW1: OOB Scheduled for Power on/off
- 2.4.13 SW2: OOB Booting
- 2.4.14 SW3: ATX Power ON Switch
- 2.4.15 J22: ATX Power ON Connector
- 2.4.16 CN6: Gigabit LAN Port
- 2.4.17 CN5: 2.5 Gigabit LAN Port
- 2.4.18 CN7: Micro USB Connector For OOB FW Upgrade.
- 2.4.19 CN3 / CN4: COM1 RS-232/422/485, COM2 RS-232 Connector
- 2.4.20 CN1: SIM Slot
- 2.4.21 J1: Battery Connector
- 2.4.22 J2: SPI Flash Connector
- 2.4.23 J4: M.2 E-Key Slot
- 2.4.24 J5 / J6: DDR5 SO-DIMM socket
- 2.4.25 J8: M.2 B-Key 3052 Slot
- 2.4.26 J11: J9: M.2 (M-Key) 2280 Slot
- 2.4.27 J20: Front Panel Settings Connector
- 2.4.28 CPU_FAN1: CPU Fan Power Connector
- 2.4.29 SYS_FAN1, SYS_FAN2: System Fan Power Connectors
- 2.4.30 SYS_FAN3: System Fan Power Connector

2.4.1 JP1: Clear ME Contents

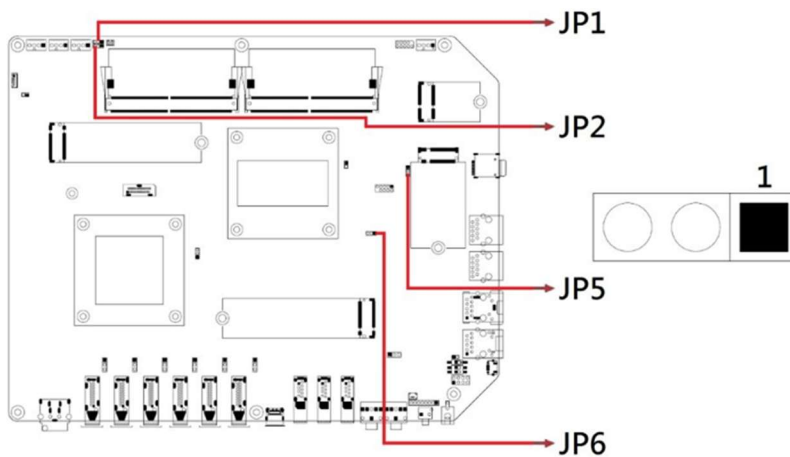

Function	Pin closed	Illustration
Normal (default)	1-2	1
Clear ME	2-3	1

2.4.2 JP2: Clear CMOS Data

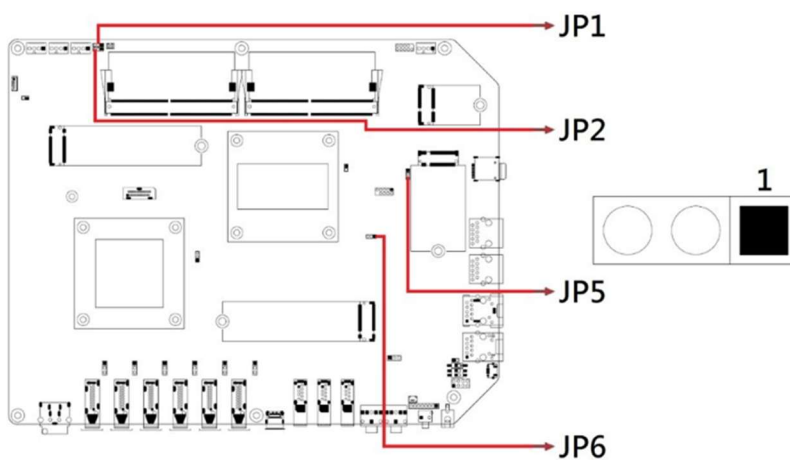

Function	Pin closed	Illustration
Normal (default)	1-2	1
Clear CMOS	2-3	1

2.4.3 JP4: IASH Descriptor Security Override

Remarks: JP4 is for factory use only.

2.4.4 JP5: Sierra EM9191 5G Card USB/PCIe Select

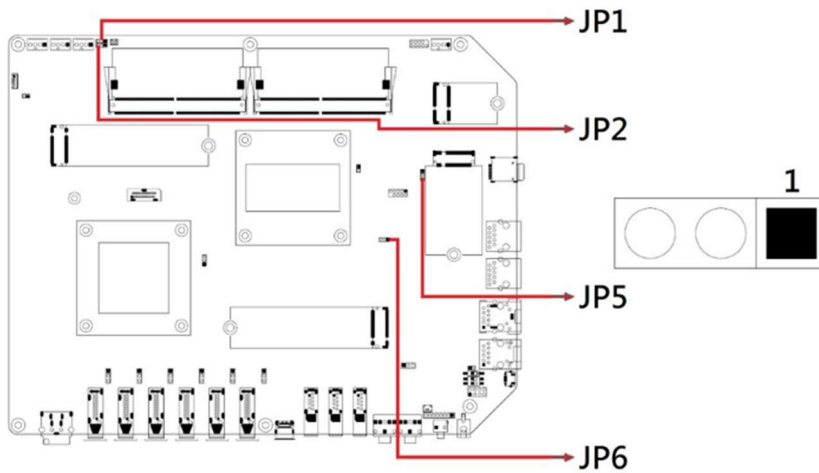

Function	Pin closed	Illustration
USB	1-2	1
PCIe (default)	2-3	1

2.4.5 JP6: ATX / AT Power Mode Select

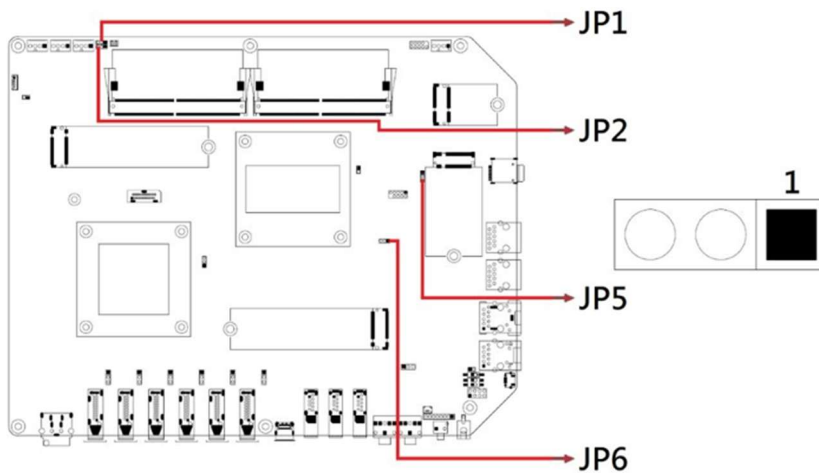

Function	Pin closed	Illustration
ATX mode (default)	1-2	1
AT mode	2-3	1

2.4.6 CN8: DC Power Input

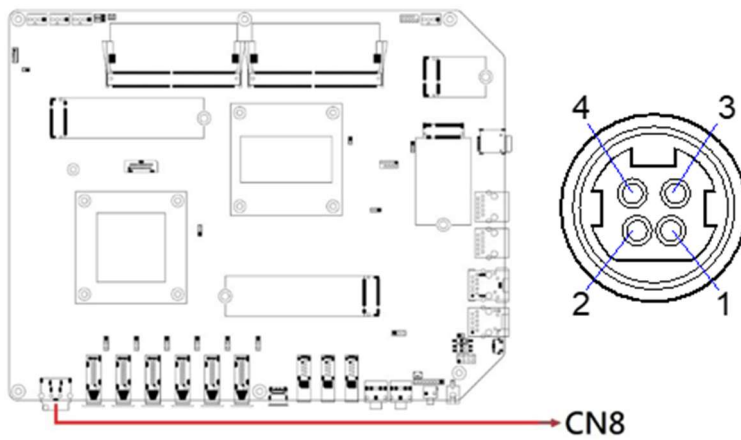

Pin	Signal	Pin	Signal
1	Ground	3	+12V
2	Ground	4	+12V

2.4.7 CN9 / CN10 / CN11 / CN12 / CN13 /CN14: HDMI Ports

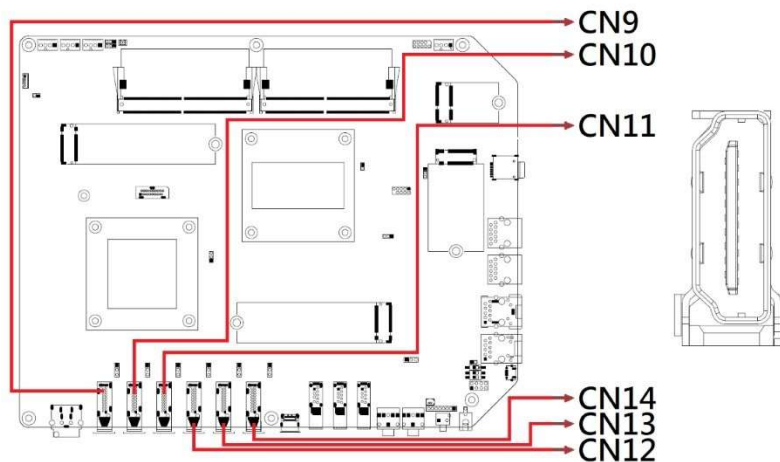

2.4.8 CN15: USB Type C Connector

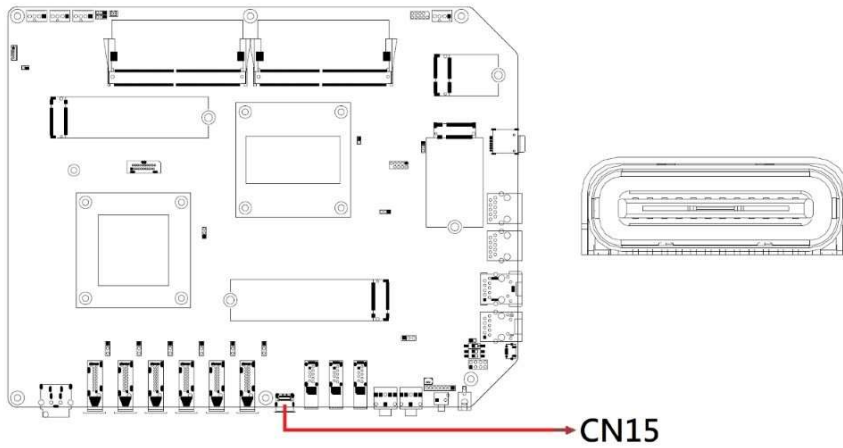

Note: Default USB 3.2 support, DP by BIOS setting for debug using , DC Output: +5V/3A

2.4.9 CN16 / CN17 / CN18: USB 3.2 Ports

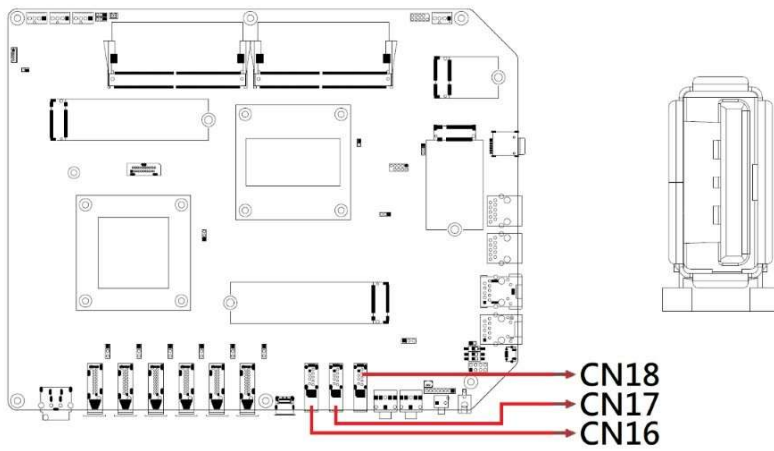

Note: CN18 supports PDPC

2.4.10 CN19: Audio Line-in

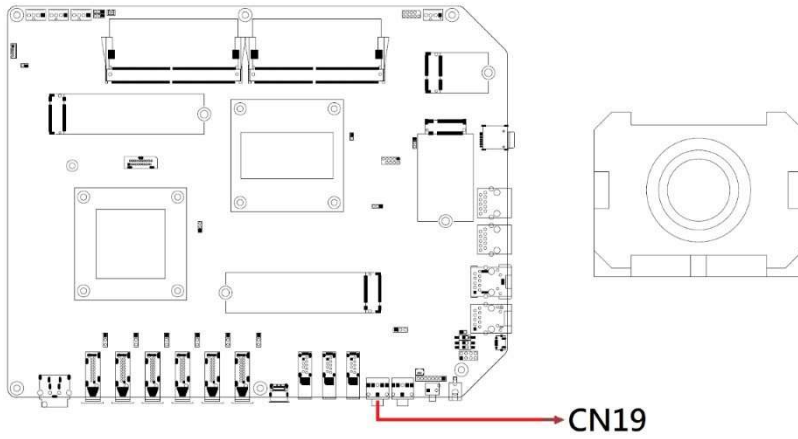

2.4.11 CN20: Audio Line-out

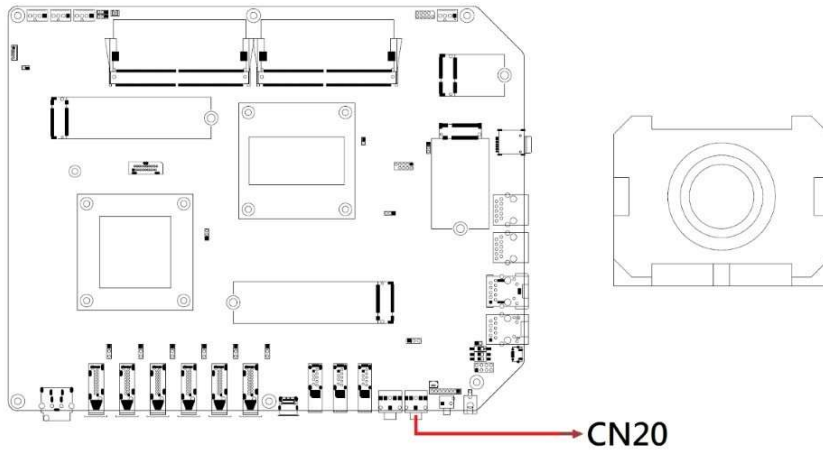

2.4.12 SW1: OOB Scheduled for Power on/off

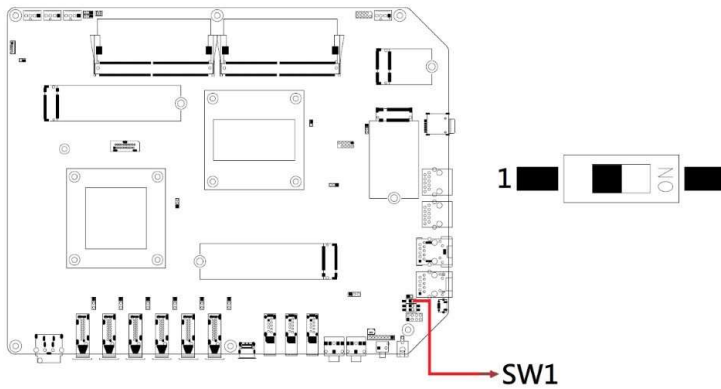

Function	Setting
Disable (default)	P1-OFF
Enable	P1-ON

2.4.13 SW2: OOB Booting

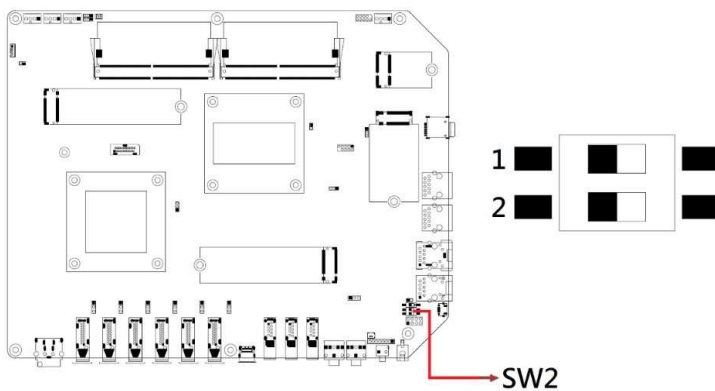

Function	Setting
QSPI Flash (default)	P1-OFF
	P2-OFF
USB	P1-ON
	P2-ON

Remarks: Factory use only.

2.4.14 SW3: ATX Power ON Switch

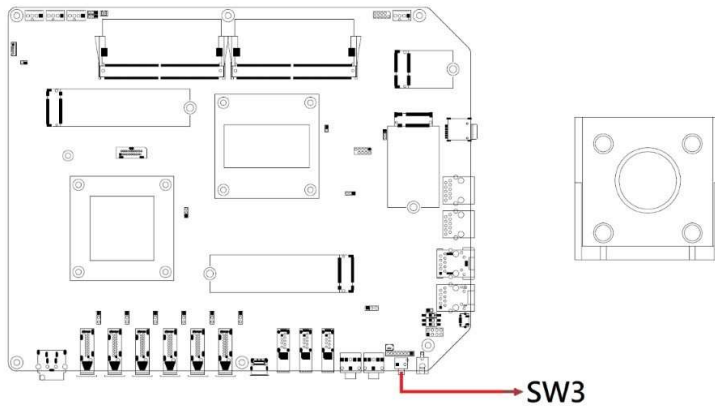

2.4.15 J22: ATX Power ON Connector

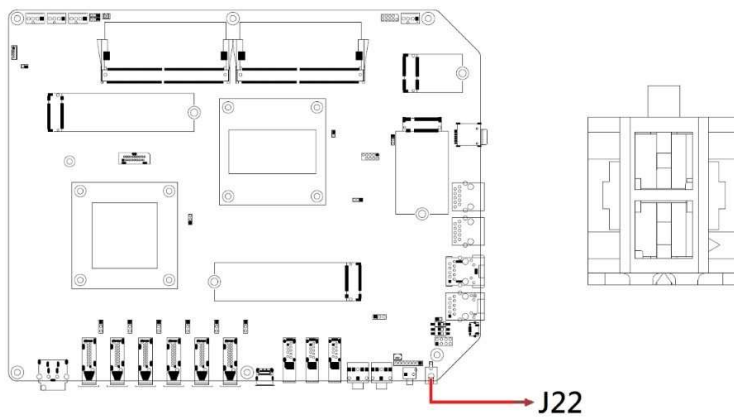

Pin	Signal	Pin	Signal
1	Power BTN-	2	Power BTN+

2.4.16 CN6: Gigabit LAN Port

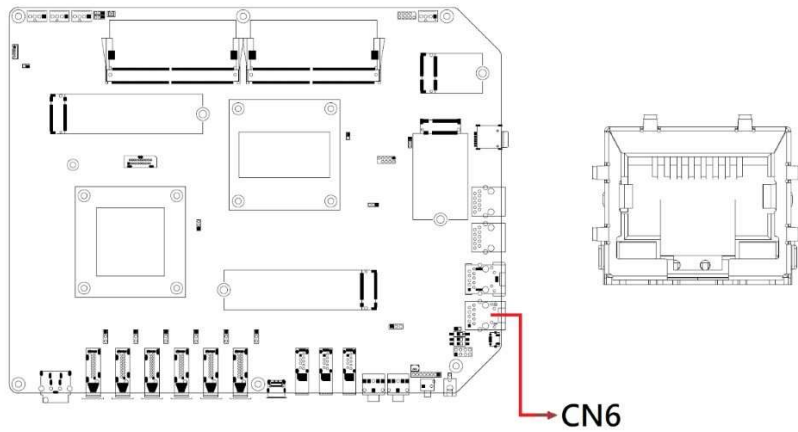

2.4.17 CN5: 2.5 Gigabit LAN Port

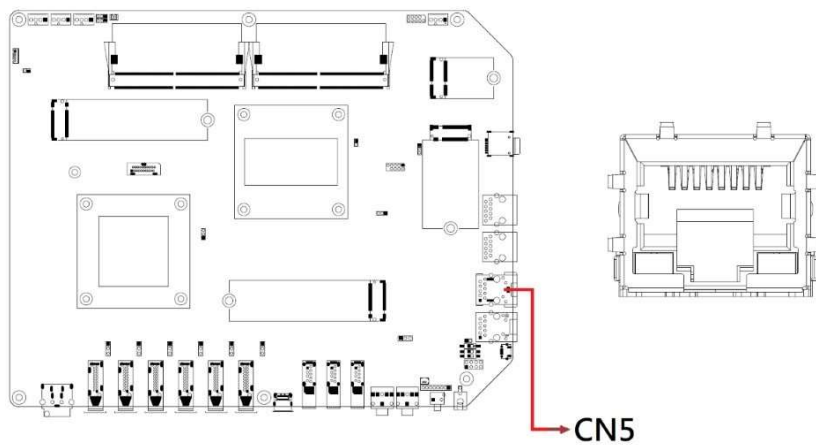

2.4.18 CN7: Micro USB Connector For OOB FW Upgrade.

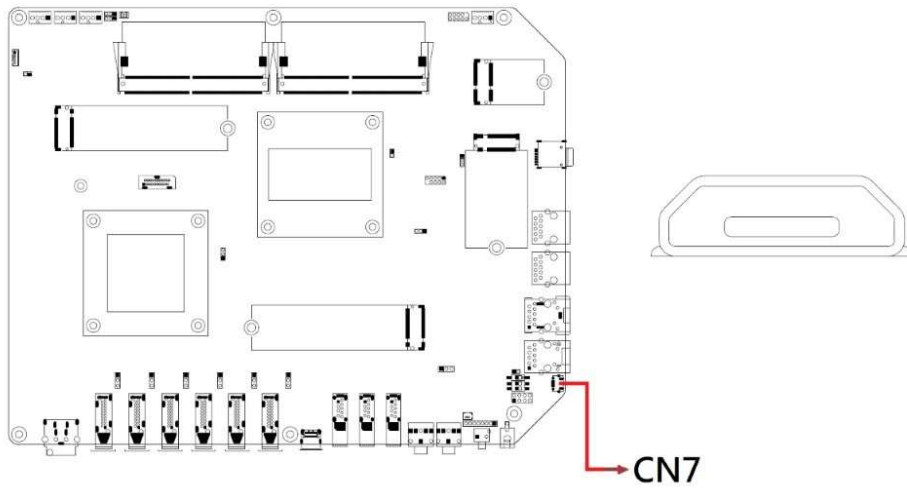

2.4.19 CN3: COM2 RS-232 Connector; CN4: COM1 RS-232/422/485

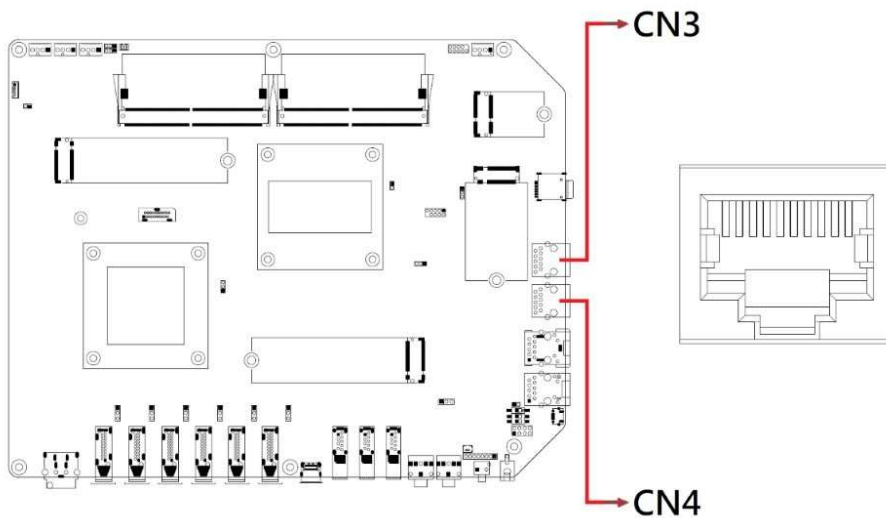

COM1 RS-232/422/485 ports are jumper-less and configurable in BIOS

2.4.20 CN1: SIM Slot

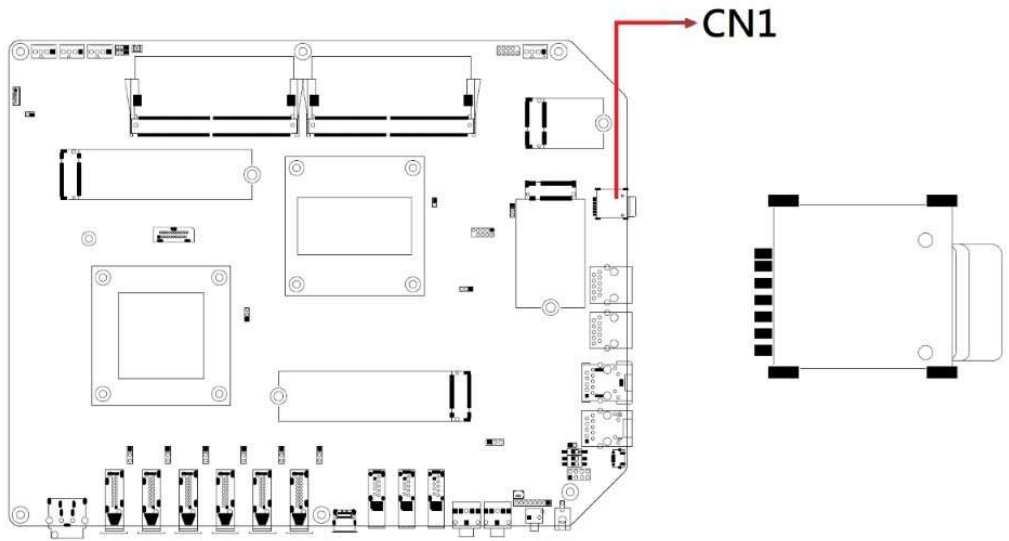

2.4.21 J1: Battery Connector

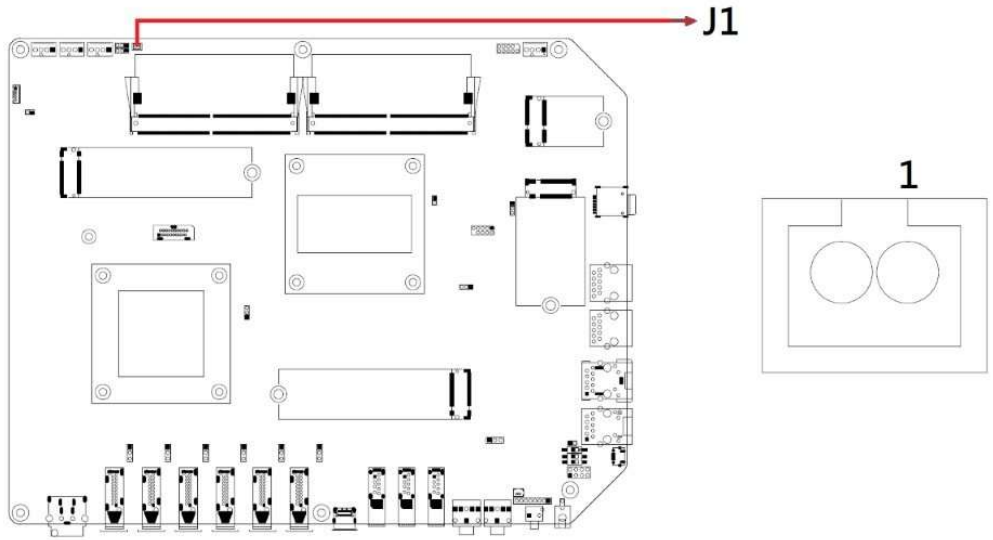

2.4.22 J2: SPI Flash Connector

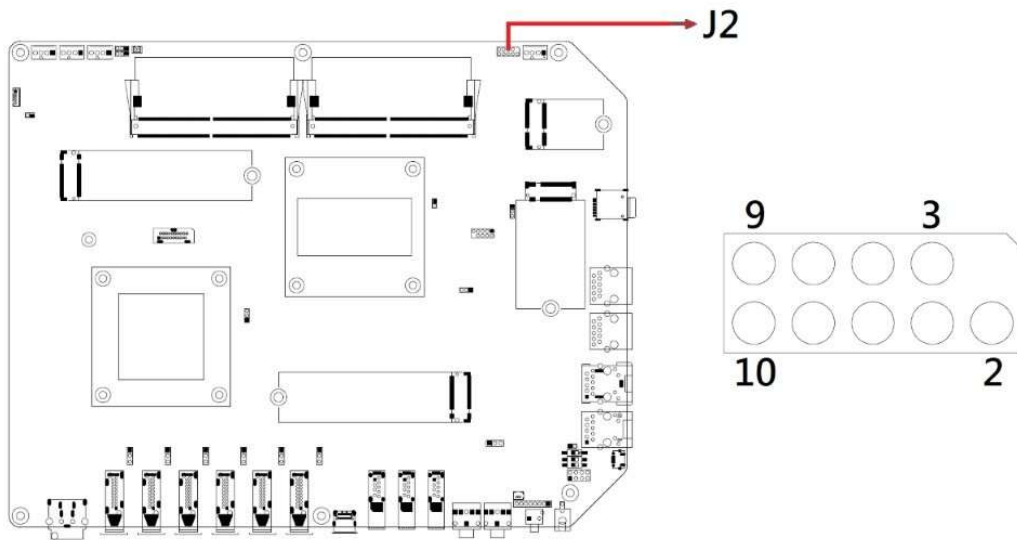

Remarks: Factory use only

2.4.23 J4: M.2 E-Key Slot

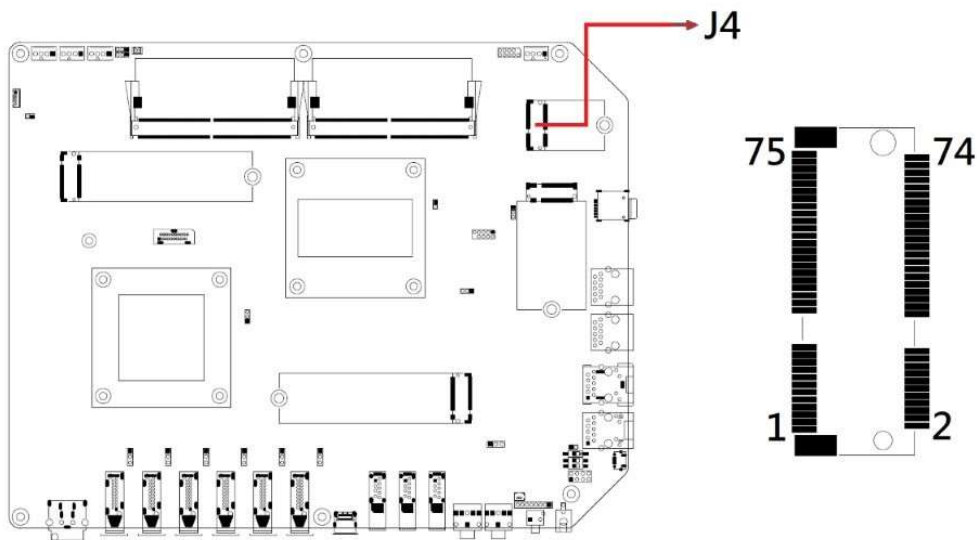

Note: J4 Slot supports PDPC.

2.4.24 J5 / J6: DDR5 SO-DIMM socket

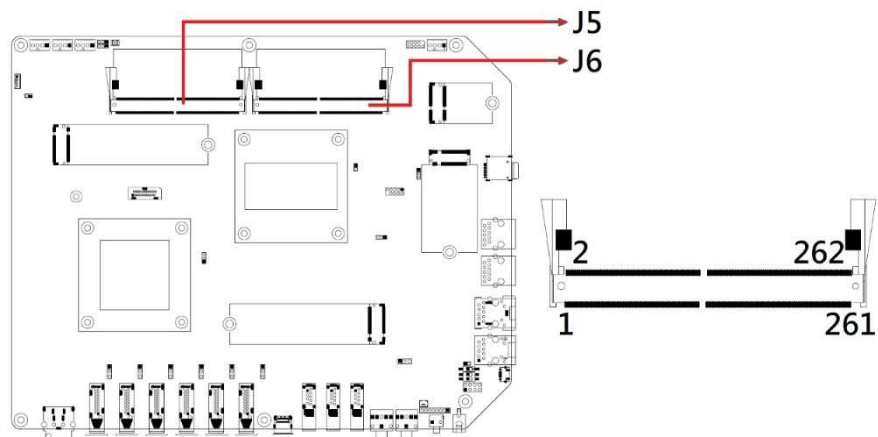

2.4.25 J8: M.2 B-Key 3052 Slot

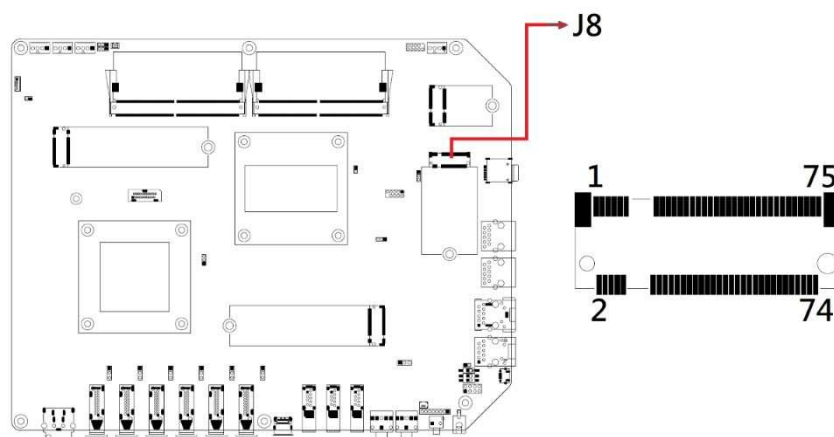

Remarks: J8 supports USB2.0/3.2 & PCIE(1x) & SIM card

2.4.26 J11: J9: M.2 (M-Key) 2280 Slot

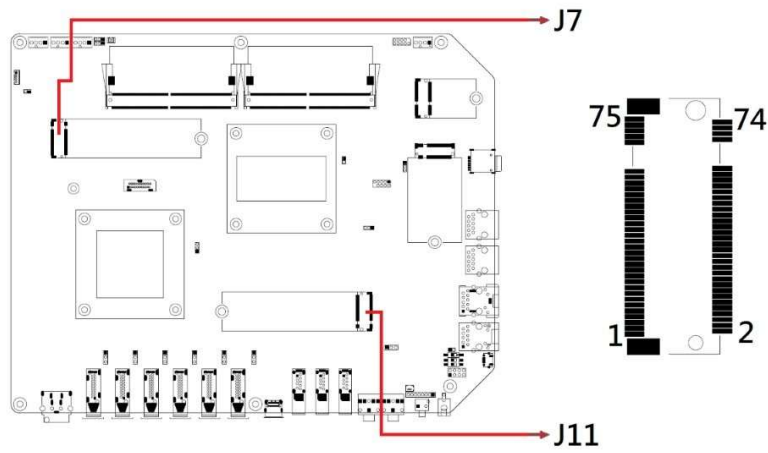

Remarks: J11 supports NVMe/ PCIe (4x) & SATA

2.4.27 J20: Front Panel Settings Connector

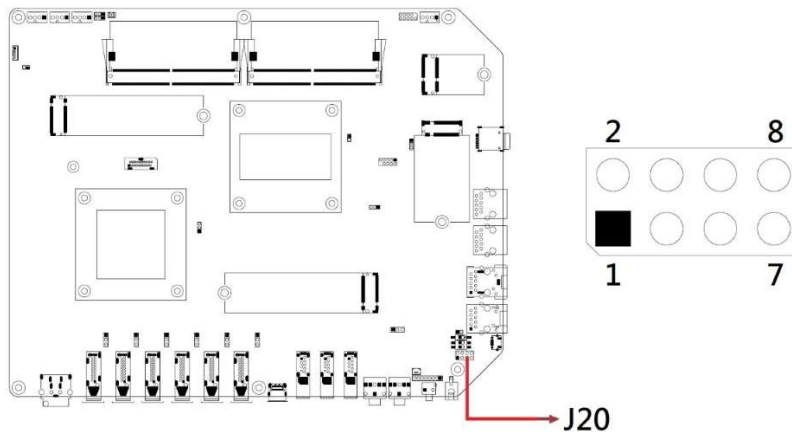

Pin	Signal	Pin	Signal
1	Power BTN-	2	Power BTN+
3	HDD LED+	4	HDD LED-
5	Reset BTN-	6	Reset BTN+
7	Power LED+	8	Power LED-

J20 is utilized for system indicators to provide light indication of the computer activities and switches to change the computer status. It provides interfaces for the following functions.

ATX Power ON Switch (Pins 1 and 2)

The 2 pins make an “ATX Power Supply On/Off Switch” for the system that connects to the power switch on the case. When pressed, the power switch will force the system to power on. When pressed again, it will power off the system.

Hard Disk Drive LED Connector (Pins 3 and 4)

This connector connects to the hard drive activity LED on control panel. This LED will flash when the HDD is being accessed.

Reset Switch (Pins 5 and 6)

The reset switch allows you to reset the system without turning the main power switch off and then on again. Orientation is not required when making a connection to this header.

Power LED (Pins 7 and 8)

This connector connects to the system power LED on control panel. This LED will light when the system turns on.

2.4.28 CPU_FAN1: CPU Fan Power Connector

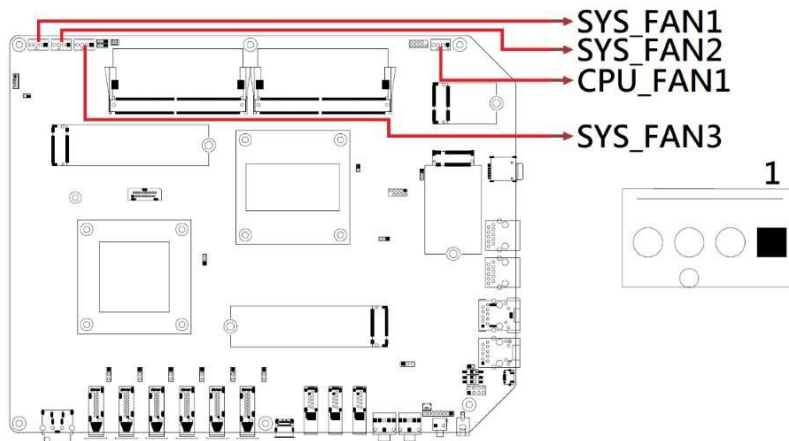

Pin	Signal Name	Pin	Signal Name
1	Ground	3	Rotation detection
2	+12V	4	Control

2.4.29 SYS_FAN1, SYS_FAN2: System Fan Power Connectors

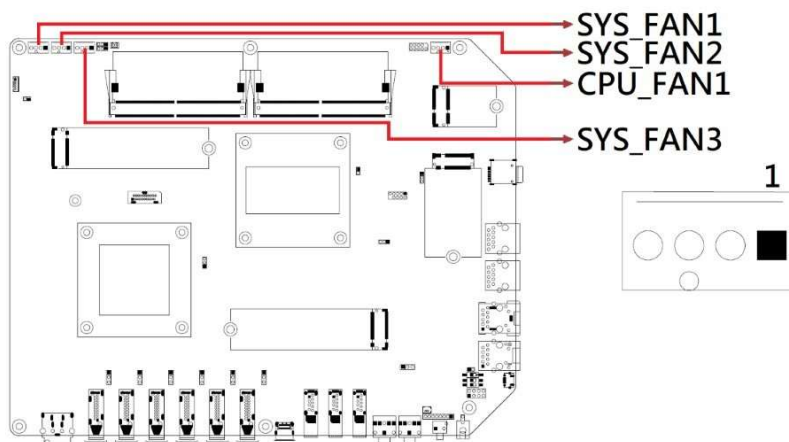

Pin	Signal Name	Pin	Signal Name
1	Ground	3	Rotation detection
2	+12V	4	Control

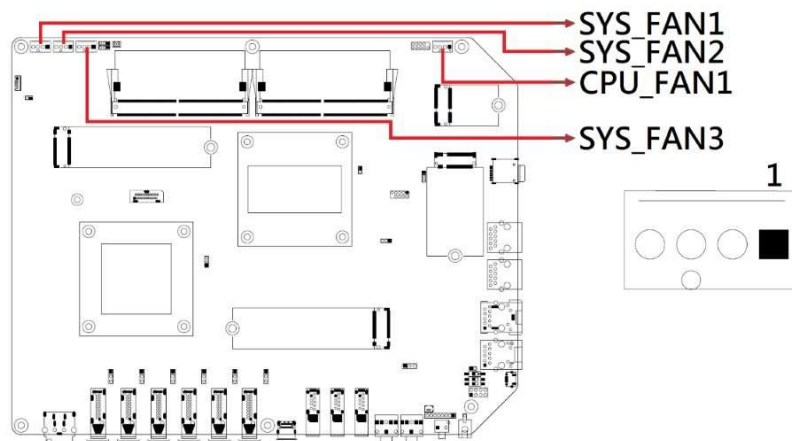
2.4.30 SYS_FAN3: System Fan Power Connector

Pin	Signal Name	Pin	Signal Name
1	Ground	3	NC
2	+12V	4	NC

Chapter 3

Driver Installation

The information provided in this chapter includes:

- Intel® Chipset Software Installation Utility
- HD Audio Driver Installation
- LAN Driver Installation
- Intel® Management Engine Driver Installation
- USB 3.1 Driver Installation

3.1 Introduction

This section describes the installation procedures for software drivers. The software drivers are available on IBASE website www.ibase.com.tw. Go to the download page of the product. Copy the compressed drivers file to your computer. Double click the file to decompress it. Run “CDGuide” to go to the main drivers page.

Note: After installing your Windows operating system, you must install the Intel® Chipset Software Installation Utility first before proceeding with the drivers installation.

3.2 Intel® Chipset Software Installation Utility

The Intel® Chipset drivers should be installed first before the software drivers to install INF files for Plug & Play function for the chipset components. Follow the instructions below to complete the installation.

1. Run the **Setup.exe** file.
2. When the *Welcome* screen to the Intel® Chipset Device Software appears, click **Next** to continue.



- 3. Accept the license agreement and proceed with the installation process.

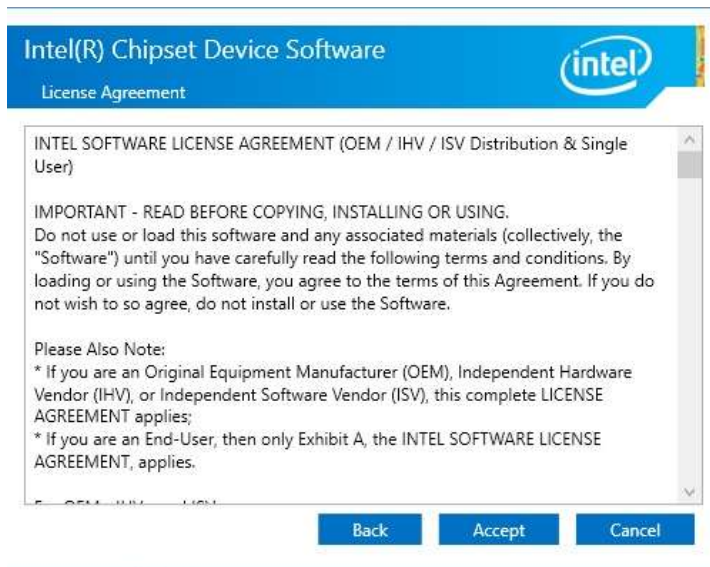

- 4. On the *Readme File Information* screen, click **Install**.

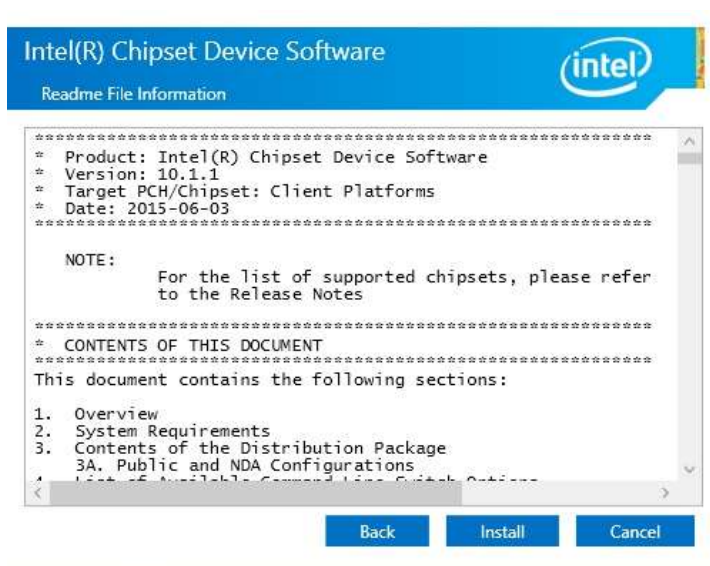

- 5. Installation is now complete. Restart the system for changes to take effect.

3.3 Intel® Graphics Driver Installation

1. Run the **Setup.exe** file.
2. When the *Welcome* screen appears, click **Next** to continue.

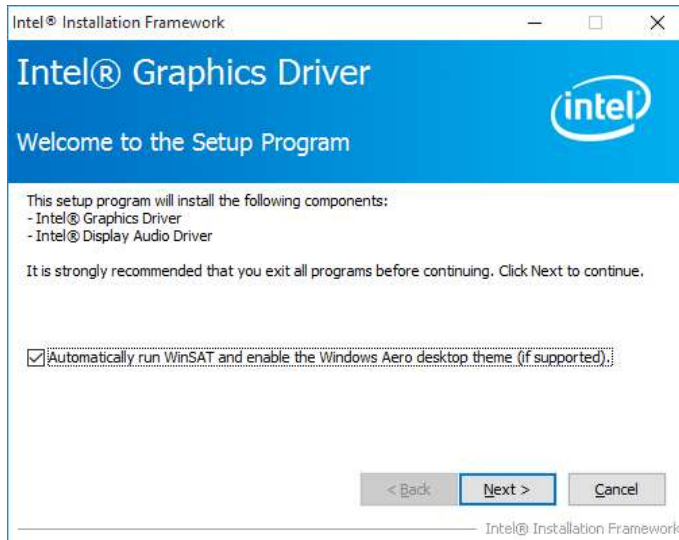

3. Click **Yes** to agree with the license agreement and continue the installation.

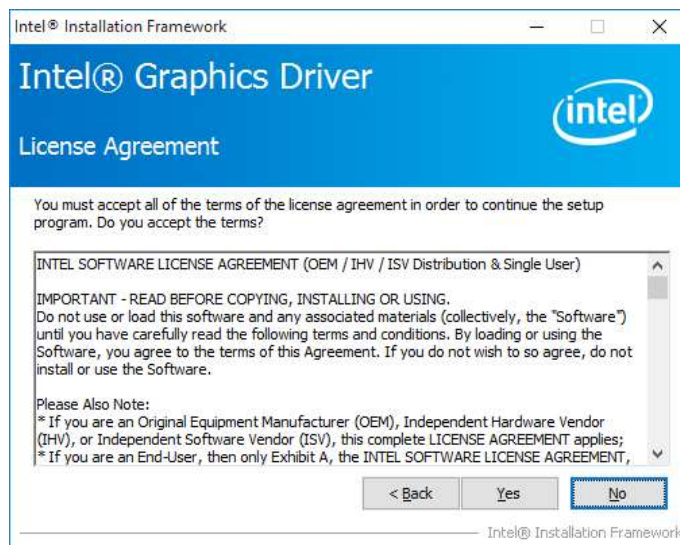

4. On the *Readme File Information* and *Setup Progress* screen, click **Next**.

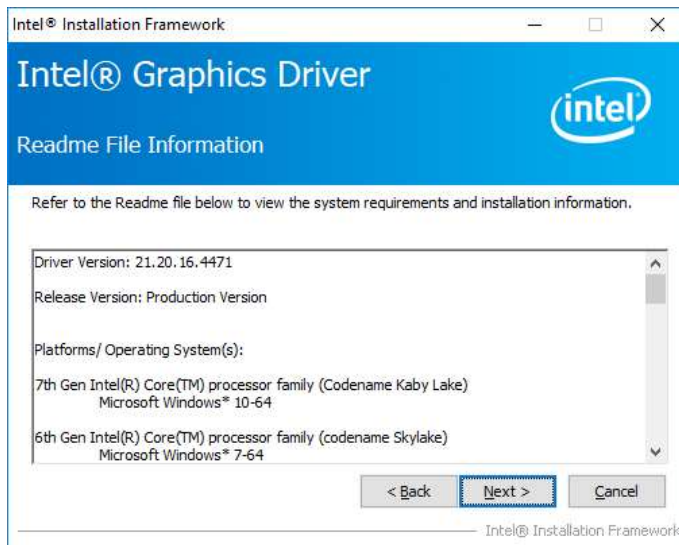

5. Choose a destination folder for installation.
6. Installation is now complete. Restart the system for changes to take effect.

3.4 HD Audio Driver Installation

1. Run the **Setup.exe** file and the wizard starts.

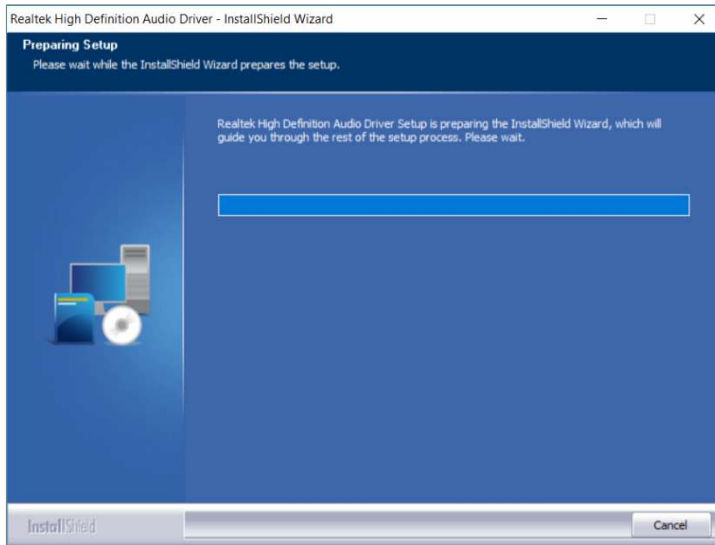

2. On the *Welcome* screen of the InstallShield Wizard, click **Next** to start installing the audio driver on your system.

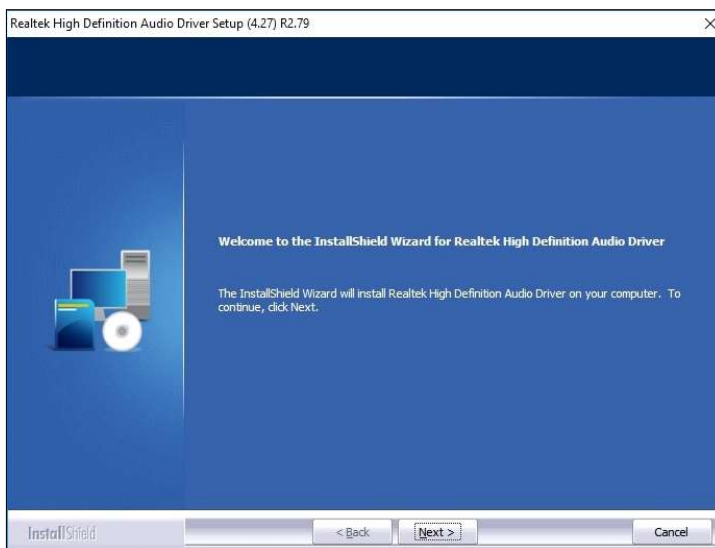

3. Installation is now complete. Restart the system for changes to take effect.

3.5 LAN Driver Installation

1. Run the **Setup.exe** file.
2. On the *Welcome* screen of the InstallShield Wizard, click **Next** to continue.

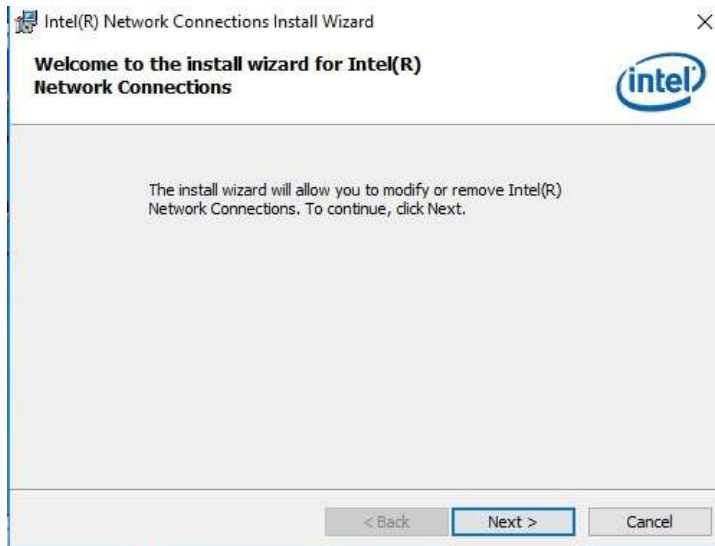

3. Accept the license agreement and click **Next**.
4. On the *Setup Options* screen, tick the checkbox to select the desired driver(s) and click **Next**.

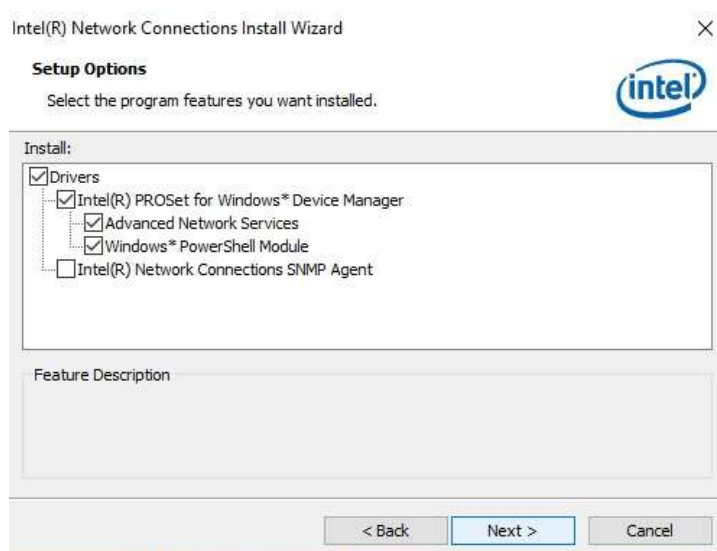

5. When the wizard is ready for installation, click **Install**.
6. Installation is now complete. Restart the system for changes to take effect.

3.6 Intel® Management Engine Components Drivers Installation

1. Run the **Setup.exe** file.
2. When the *Welcome* screen appears, click **Next**.

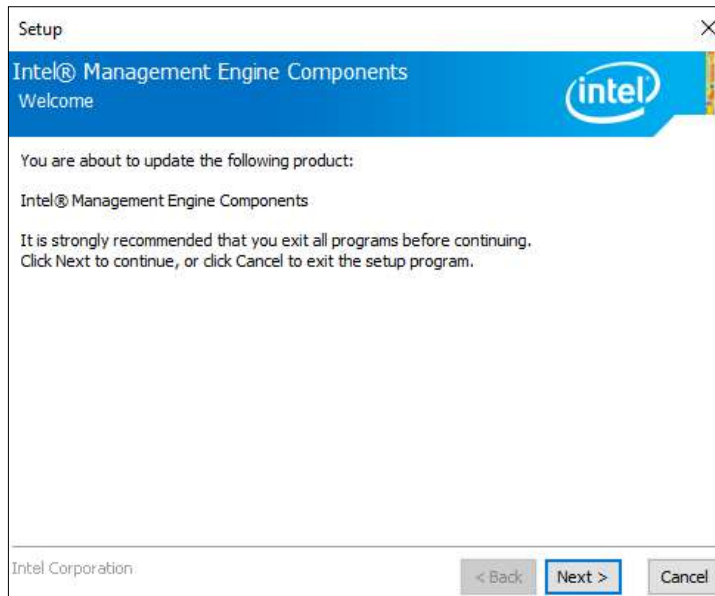

3. Accept the license agreement and click **Next** for installation.

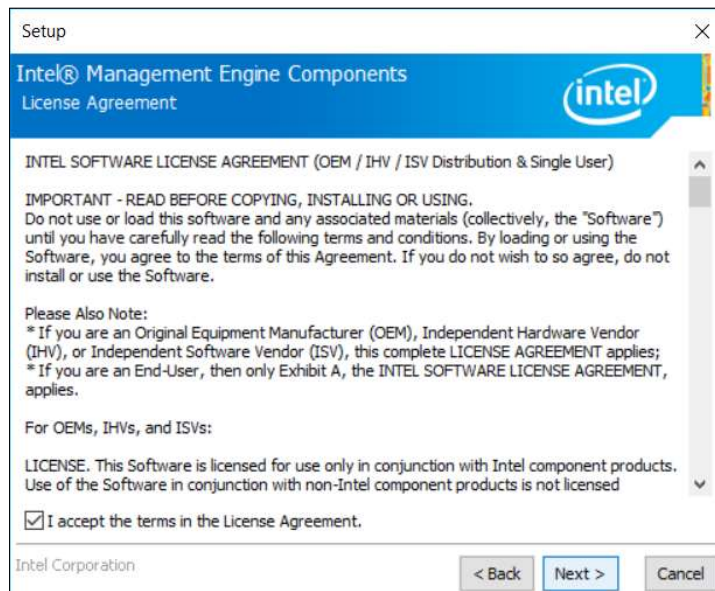

4. Installation is now complete. Restart the system for changes to take effect.

Chapter 4

BIOS Setup

This chapter describes the different settings available in the AMI BIOS that comes with the board. The topics covered in this chapter are as follows:

- Main Settings
- Advanced Settings
- Chipset Settings
- Security Settings
- Boot Settings
- Save & Exit

4.1 Introduction

The BIOS (Basic Input/Output System) installed in the ROM of your computer system supports Intel® processors. The BIOS provides critical low-level support for standard devices such as disk drives, serial ports and parallel ports. It also provides password protection as well as special support for detailed fine-tuning of the chipset controlling the entire system.

4.2 BIOS Setup

The BIOS provides a Setup utility program for specifying the system configurations and settings. The BIOS ROM of the system stores the Setup utility. When you turn on the computer, the BIOS is immediately activated. Press the key immediately allows you to enter the Setup utility. If you are a little bit late pressing the key, POST (Power On Self Test) will continue with its test routines, thus preventing you from invoking the Setup.

If you still need to enter Setup, restart the system by pressing the "Reset" button or simultaneously pressing the <Ctrl>, <Alt> and <Delete> keys. You can also restart by turning the system Off and back On again.

The following message will appear on the screen:

```
Press <DEL> to Enter Setup
```

In general, press the arrow keys to highlight items, <Enter> to select, the <PgUp> and <PgDn> keys to change entries, <F1> for help, and <Esc> to quit.

When you enter the BIOS Setup utility, the *Main Menu* screen will appear on the screen. The Main Menu allows you to select from various setup functions and exit choices.

Warning: It is strongly recommended that you avoid making any changes to the chipset defaults.

These defaults have been carefully chosen by both AMI and your system manufacturer to provide the absolute maximum performance and reliability. Changing the defaults could make the system unstable and crash in some cases.

4.3 Main Settings

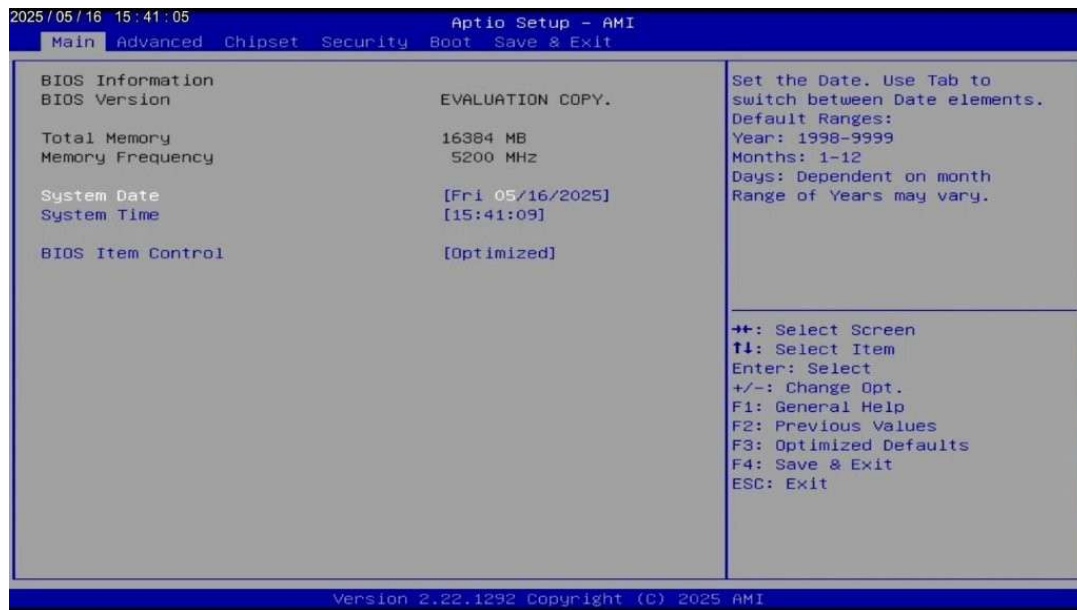

BIOS Setting	Description
System Date	Sets the date. Use the <Tab> key to switch between the data elements.
System Time	Set the time. Use the <Tab> key to switch between the data elements.

4.4 Advanced Settings

This section allows you to configure, improve your system and allows you to set up some system features according to your preference.



4.4.1 CPU Configuration



BIOS Setting	Description
Intel (VMX) Virtualization Technology	When the function is enabled, a VMM can utilize the additional hardware capabilities provided by Vanderpool Technology.
Active Performance-cores Active Efficient-cores	Number of P-cores to enable in each processor package. Note: Number of Cores and E-cores are looked at together. When both are (0,0), Pcode will enable all cores
Hyper-Threading	Enable or disable Hyper-Threading Technology.
AES	Enable/Disable AES (Advanced Encryption Standard)

4.4.2 Power & Performance



BIOS Setting	Description
CPU Power Management Control	CPU – Power Management Control Options

4.4.2.1. CPU Power Management Control

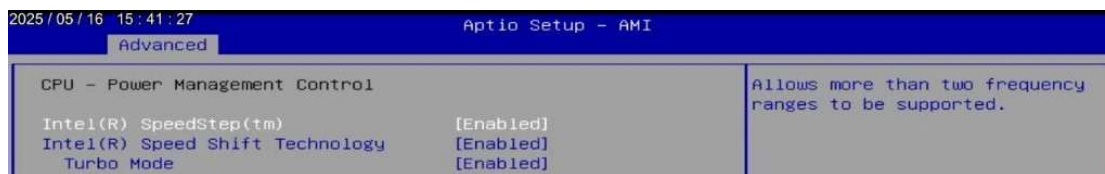

BIOS Setting	Description
Intel Speed Step(tm)	Allows more than two frequency ranges to be supported.
Intel(R) Speed Shift Technology Turbo Mode	Enables / Disables Intel(R) Speed Shift Technology support. Enabling will expose the CPPC v2 interface to allows for hardware-controlled P-states.
Turbo Mode	Enables / Disables processor Turbo Mode (requires EMTTM enabled too). Auto means enabled unless max. turbo ratio is bigger than 16 – SKL A0 W/A.

4.4.3 PCH-FW Configuration



4.4.4 Trusted Computing



BIOS Setting	Description
Security Device Support	Enables / Disables BIOS support for security device. OS will not show security device. TCG EFI protocol and INTIA interface will not be available.
SHA256 / SHA384 Bank	Option: Enabled / Disabled
Pending operation	Schedule an operation for the security device. Note: Your computer will reboot during restart in order to change state of security device.
Platform Hierarchy	Enables / Disables platform hierarchy.
Storage Hierarchy	Enables / Disables storage hierarchy.
Endorsement Hierarchy	Enables / Disables endorsement hierarchy.
Physical Presence Spec Version	Selects to show the PPI Spec Version (1.2 or 1.3) that the OS supports. Note: Some HCK tests might not support 1.3.
Device Select	<ul style="list-style-type: none"> • TPM 1.2 will restrict support to TPM 1.2 devices only. • TPM 2.0 will restrict support to TPM 2.0 devices only. • Auto will support both with the default being set to TPM 2.0 devices if not found, and TPM 1.2 device will be enumerated.

4.4.5 ACPI Settings



BIOS Setting	Description
Enable Hibernation	Enables / Disables System ability to hibernate (OS/S4 Sleep State). This option may not be effective with some operating systems.
ACPI Sleep State	Select the highest ACPI sleep state the system will enter when the Suspend button is pressed.
Lock Legacy Resources	Enables / Disables Lock of Legacy Resources.

4.4.6 iSmart Controller



BIOS Setting	Description
Power-On after Power failure	Enables / Disables the system to be turned on automatically after a power failure.
PWR Resume Delay	Enables / Disables power-on resume delay.
Temperature Guardian	Generate the reset signal when system hands up on POST.
Schedule Slot 1 / 2	<p>Sets up the hour / minute for system power-on.</p> <p>Important: If you would like to set up a schedule between adjacent days, configure two schedule slots.</p> <p>For example, if setting up a schedule from Wednesday 5 p.m. to Thursday 2 a.m., configure two schedule slots. But if setting up a schedule from 3 p.m to 5 p.m. on Wednesday, configure only a schedule slot.</p>
Power Unlocker	iSmart will monitor the system power status. If it is unable to boot within 6 seconds when the system is shut down and the power button is pressed, it will activate the recovery process. iSmart controller will perform the RTC clear sequence and then trigger the power button to turn on the system.

4.4.7 Super IO Configuration



Remarks: COM3 is for OOB model use only

BIOS Setting	Description
Serial Port Configuration	Sets parameters of Serial Ports (COMA). Enables / Disables the serial port and select optimal settings for the Super IO device.



4.4.8 Hardware Monitor

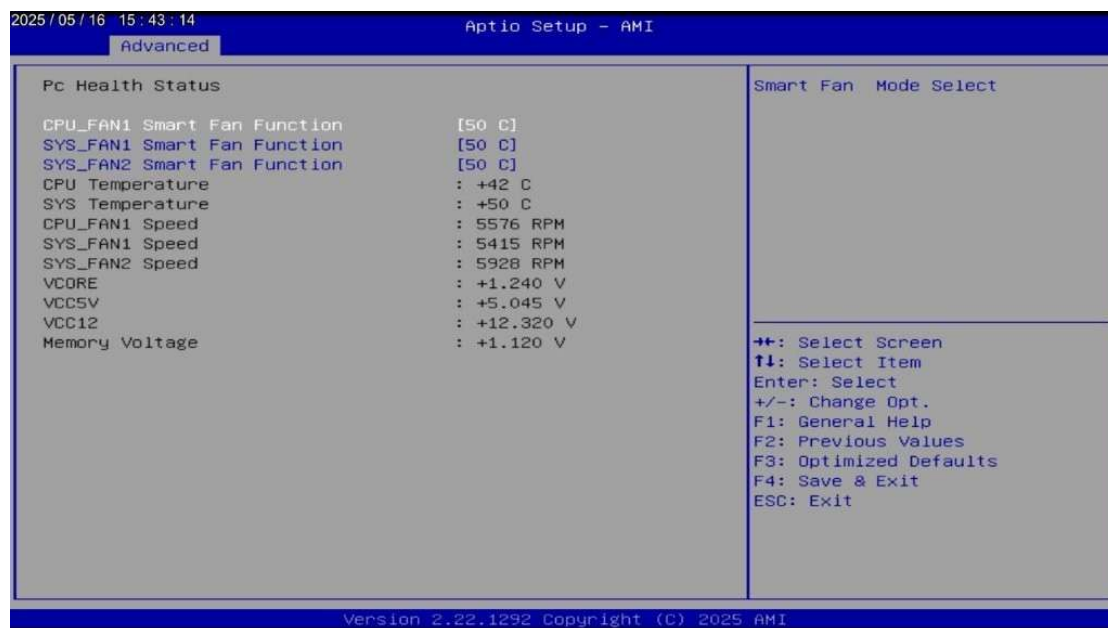

BIOS Setting	Description
CPU / System Fan Smart Fan	Sets the temperature limit of fans in the system.
CPU Shutdown Temperature	This field enables or disables the Shutdown Temperature
Temperatures / Voltages	These fields are the parameters of the hardware monitoring function feature of the motherboard. The values are read-only values as monitored by the system and show the PC health status.

4.4.9 USB Configuration

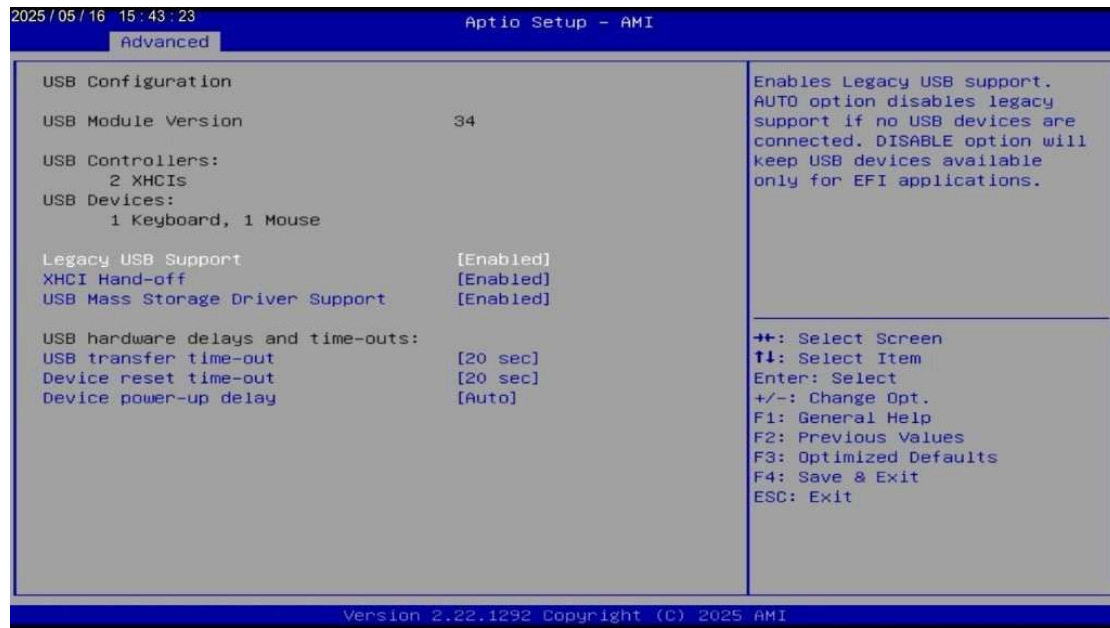

BIOS Setting	Description
Legacy USB Support	Enables / Disables Legacy USB support. <ul style="list-style-type: none"> • Auto disables legacy support if there is no USB device connected. • Disable keeps USB devices available only for EFI applications.
XHCI Hand-pff	This is a workaround for OSEs without XHCI hand-off support. The XHCI ownership change should be claimed by XHCI driver.
USB Mass Storage Driver Support	Enables / Disables USB mass storage driver support.
USB Transfer time-out	Sets the time-out value 1, 5, 10 or 20 sec(s) for Control, Bulk, and Interrupt transfers.
Device reset time-out	Sets the seconds (10, 20, 30, 40 secs) of delaying execution of start unit command to USB mass storage device.
Device power-up delay	The maximum time the device will take before it properly reports itself to the Host Controller. Auto uses default value. For a Root port, it is 100 ms. For a Hub port, the delay is taken from Hub descriptor.

4.4.10 Network Stack Configuration



4.4.11 NVMe Configuration

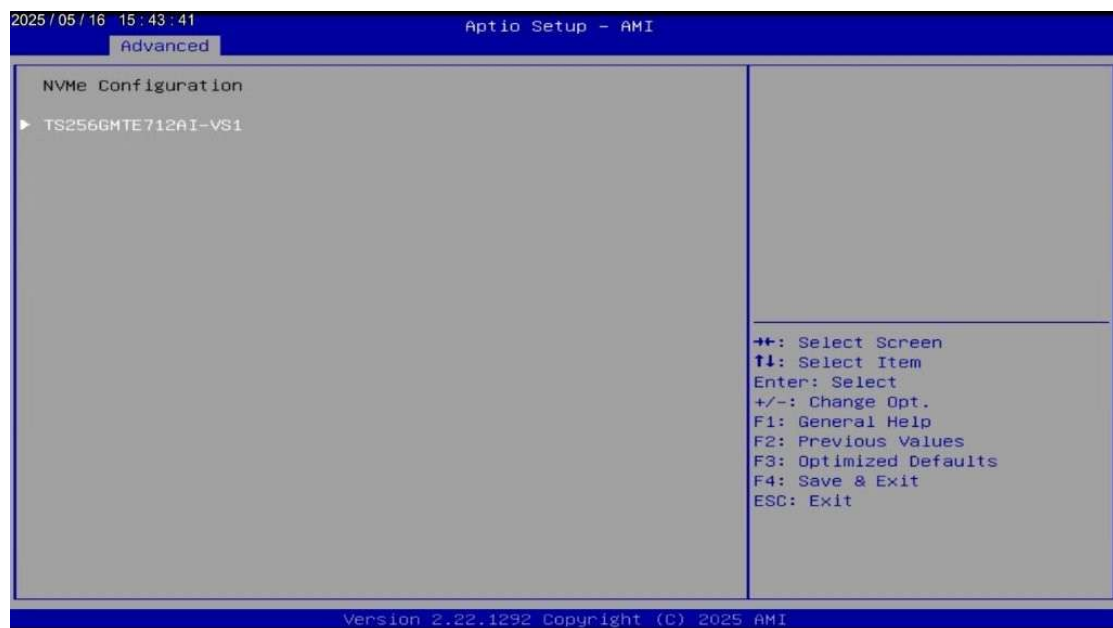

4.5 Chipset Settings

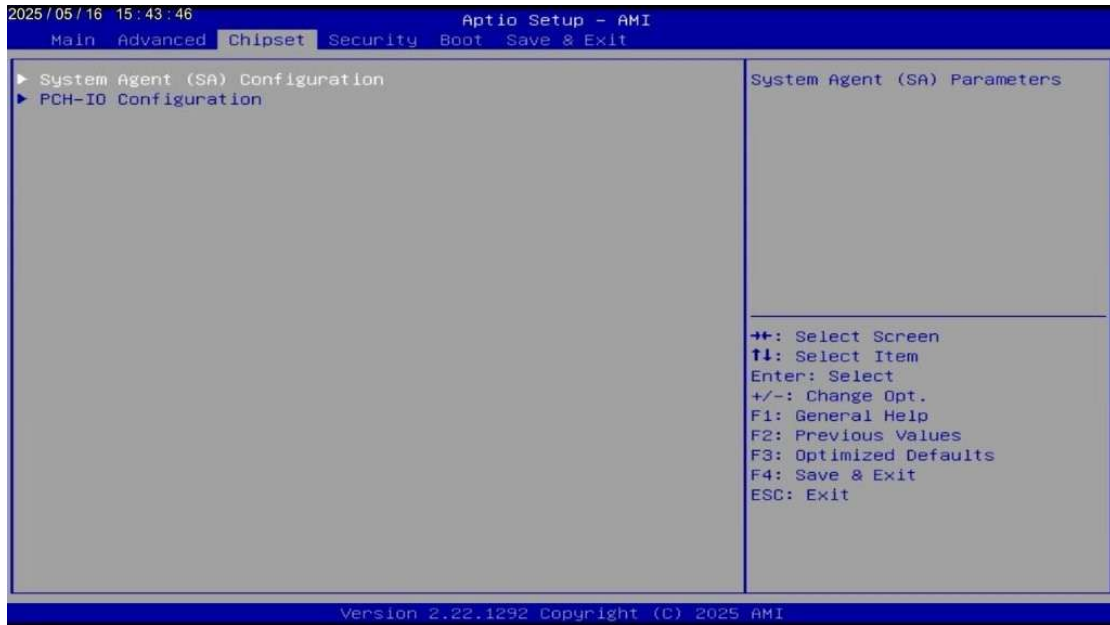

BIOS Setting	Description
System Agent (SA) Configuration	System Agent parameters
PCH-IO Configuration	PCH parameters

4.5.1 System Agent Configuration



BIOS Setting	Description
Graphics Configuration	Graphics Configuration
VT-d	VT-d capability
Control Iommu Pre-boot Behavior	Enable IOMMU in Pre-boot environment (If DMAR table is installed in DXE and if VT_INFO_PPI is installed in PEI.)

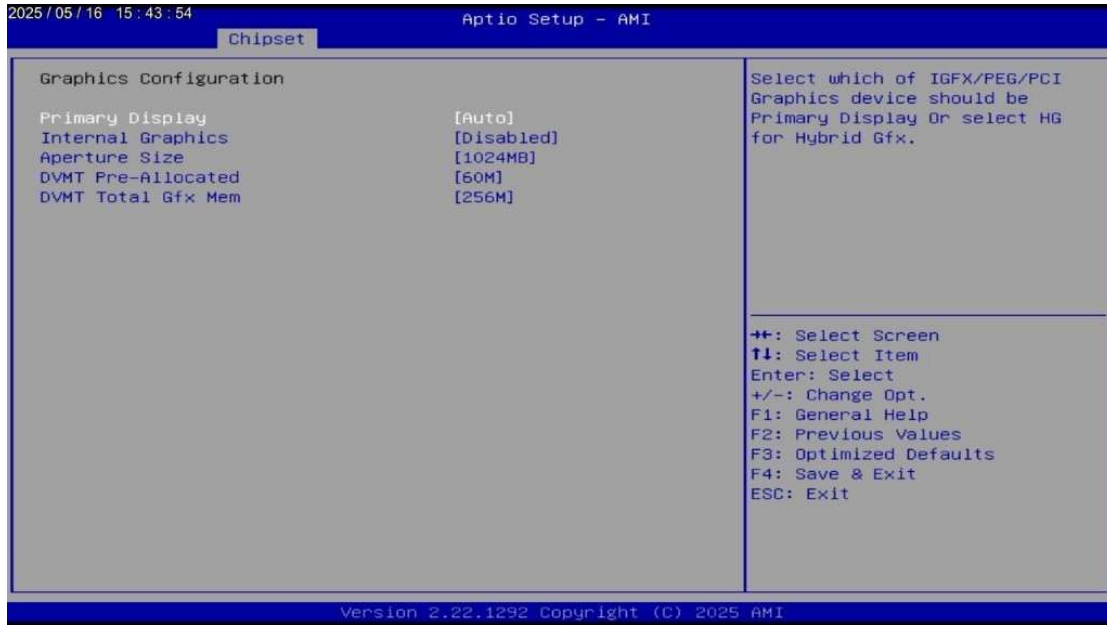

BIOS Setting	Description
Primary Display	Select which of IGFX/PEG/PCI graphics device should be primary display or select HG for Hybrid Gfx.
VT-d	VT-d capability
Internal Graphics	Keep IGFX enabled based on the setup options.
Aperture Size	Select the Aperture size. Note: Above 4GB MMIO BIOS assignment is automatically enabled when selecting > 2048MB aperture. To use this feature, please disable CSM support.
DVMT Pre-Allocated	Select DVMT 5.0 Pre-Allocated (Fixed) graphics memory size used by the internal graphics device.
DVMT Total Gfx Mem	Select DVMT5.0 total graphics memory size used by the internal graphics device.

4.5.2 PCH-IO Configuration

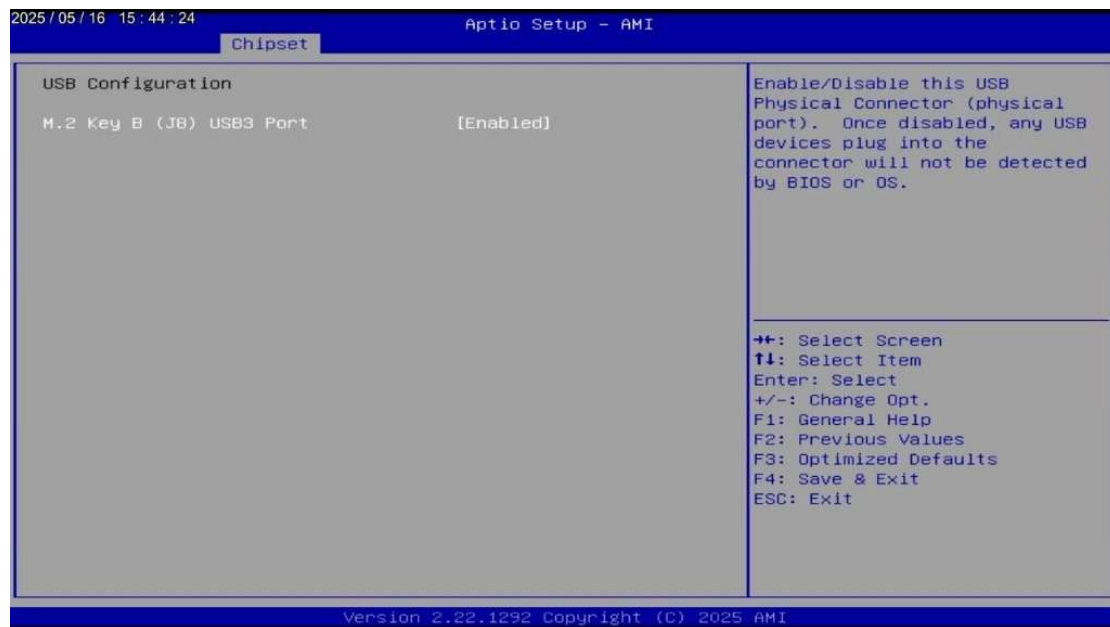

4.6 Security Settings



BIOS Setting	Description
Administrator Password	Sets an administrator password for the setup utility.
User Password	Sets a user password.
Secure Boot	Secure Boot Configuration

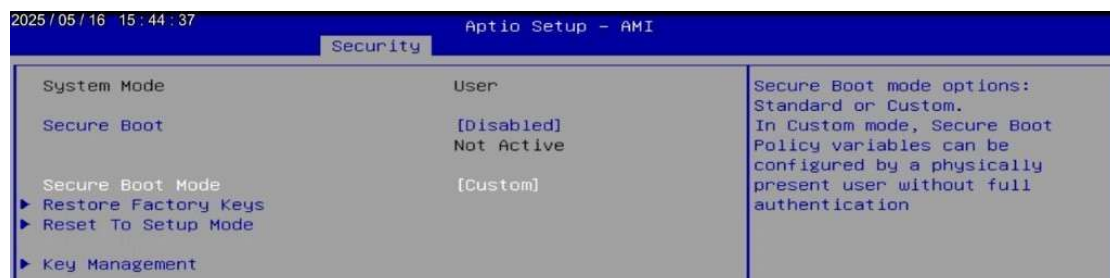
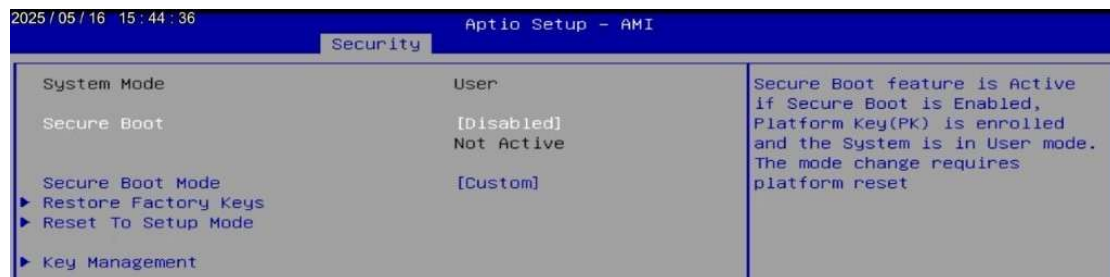

2025/05/16 15:44:40 Aptio Setup - AMI

Security		
System Mode	User	Force System to User Mode. Install factory default Secure Boot key databases
Secure Boot	[Disabled] Not Active	
Secure Boot Mode	[Custom]	
▶ Restore Factory Keys		
▶ Reset To Setup Mode		
▶ Key Management		

2025/05/16 15:44:41 Aptio Setup - AMI

Security		
System Mode	User	Delete all Secure Boot key databases from NVRAM
Secure Boot	[Disabled] Not Active	
Secure Boot Mode	[Custom]	
▶ Restore Factory Keys		
▶ Reset To Setup Mode		
▶ Key Management		

2025/05/16 15:44:42 Aptio Setup - AMI

Security		
System Mode	User	Enables expert users to modify Secure Boot Policy variables without variable authentication
Secure Boot	[Disabled] Not Active	
Secure Boot Mode	[Custom]	
▶ Restore Factory Keys		
▶ Reset To Setup Mode		
▶ Key Management		

4.7 Boot Settings

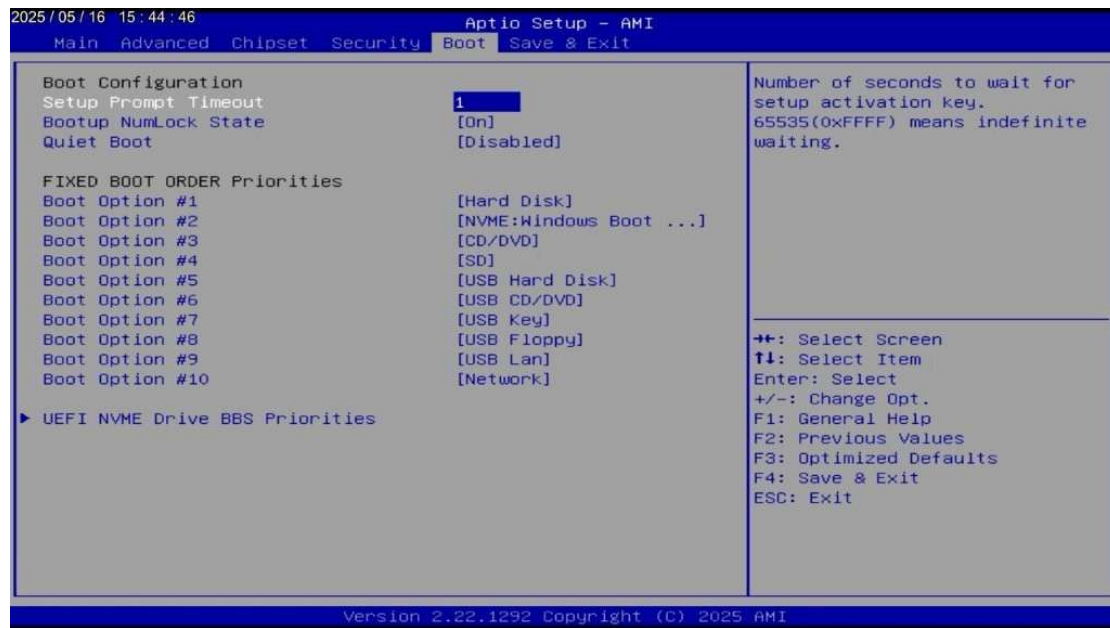

BIOS Setting	Description
Setup Prompt Timeout	Number of seconds to wait for setup activation key. 65535 (0xFFFF) means indefinite waiting.
Bootup NumLock State	Selects the keyboard NumLock state.
Quiet Boot	Enables / Disables Quiet Boot option.
UEFI NVME Drive BBS Priorities	Specifies the boot device priority sequence from available UEFI NVME drives.



4.8 Save & Exit Settings



BIOS Setting	Description
Save Changes and Exit	Exits system setup after saving the changes.
Discard Changes and Exit	Exits system setup without saving any changes.
Save Changes and Reset	Resets the system after saving the changes.
Discard Changes and Reset	Resets system setup without saving any changes.
Save Changes	Saves changes done so far to any of the setup options.
Discard Changes	Discards changes done so far to any of the setup options.
Restore Defaults	Restores / Loads defaults values for all the setup options.
Save as User Defaults	Saves the changes done so far as user defaults.
Restore User Defaults	Restores the user defaults to all the setup options.

Appendix

This section provides the mapping addresses of peripheral devices and the sample code of watchdog timer configuration.

- AMD Eyefinity Multiple Displays
- I/O Port Address Map
- Interrupt Request Lines (IRQ)
- Watchdog Timer Configuration

A. I/O Port Address Map

Each peripheral device in the system is assigned a set of I/O port addresses which also becomes the identity of the device. The following table lists the I/O port addresses used.

Address	Device Description
0x00005000-0x00005FFF	Intel(R) PCI Express Root Port #5 - 51BC
0x00000A00-0x00000A0F	Motherboard resources
0x00000A10-0x00000A1F	Motherboard resources
0x00000A20-0x00000A2F	Motherboard resources
0x0000002E-0x0000002F	Motherboard resources
0x0000004E-0x0000004F	Motherboard resources
0x00000061-0x00000061	Motherboard resources
0x00000063-0x00000063	Motherboard resources
0x00000065-0x00000065	Motherboard resources
0x00000067-0x00000067	Motherboard resources
0x00000070-0x00000070	Motherboard resources
0x00000080-0x00000080	Motherboard resources
0x00000092-0x00000092	Motherboard resources
0x000000B2-0x000000B3	Motherboard resources
0x00000680-0x0000069F	Motherboard resources
0x0000164E-0x0000164F	Motherboard resources
0x00000020-0x00000021	Programmable interrupt controller
0x00000024-0x00000025	Programmable interrupt controller
0x00000028-0x00000029	Programmable interrupt controller
0x0000002C-0x0000002D	Programmable interrupt controller
0x00000030-0x00000031	Programmable interrupt controller
0x00000034-0x00000035	Programmable interrupt controller
0x00000038-0x00000039	Programmable interrupt controller
0x0000003C-0x0000003D	Programmable interrupt controller
0x000000A0-0x000000A1	Programmable interrupt controller
0x000000A4-0x000000A5	Programmable interrupt controller

Address	Device Description
0x000000A8-0x000000A9	Programmable interrupt controller
0x000000AC-0x000000AD	Programmable interrupt controller
0x000000B0-0x000000B1	Programmable interrupt controller
0x000000B4-0x000000B5	Programmable interrupt controller
0x000000B8-0x000000B9	Programmable interrupt controller
0x000000BC-0x000000BD	Programmable interrupt controller
0x000004D0-0x000004D1	Programmable interrupt controller
0x000003F8-0x000003FF	Communications Port (COM1)
0x000002F8-0x000002FF	Communications Port (COM2)
0x000003E8-0x000003EF	Communications Port (COM3)
0x000002E8-0x000002EF	Communications Port (COM4)
0x00006F00-0x00006FFF	AMD Radeon E8860
0x00001854-0x00001857	Motherboard resources
0x00000000-0x00000CF7	Pci Bus
0x00000D00-0x0000FFFF	Pci Bus
0x0000EFA0-0x0000EFBF	Intel(R) SMBus - 51A3
0x00004000-0x00004FFF	Intel(R) PCI Express Root Port #6 - 51BD
0x00006000-0x00006FFF	PCI Express Root Port
0x00002000-0x000020FE	Motherboard resources
0x00000040-0x00000043	System timer
0x00000050-0x00000053	System timer
0x00000060-0x00000060	Standard PS/2 Keyboard
0x00000064-0x00000064	Standard PS/2 Keyboard
0x00003000-0x00003FFF	Intel(R) PCI Express Root Port #8 - 51BF

B. Interrupt Request Lines (IRQ)

Peripheral devices use interrupt request lines to notify CPU for the service required. The following table shows the IRQ used by the devices on board.

Level	Function
IRQ 4294967293	Intel(R) PCI Express Root Port #5 - 51BC
IRQ 4294967289	Intel(R) PCI Express Root Port #9 - 51B0
IRQ 4294967238	Intel® Smart Sound Technology BUS
IRQ 4294967291	Intel(R) PCI Express Root Port #7 - 51BE
IRQ 4294967237	Intel(R) Management Engine Interface #1
IRQ 4	Communications Port (COM1)
IRQ 3	Communications Port (COM2)
IRQ 5	Communications Port (COM3)
IRQ 7	Communications Port (COM4)
IRQ 4294967272	AMD Radeon E8860
IRQ 4294967239-53	Intel(R) Ethernet Controller I226-LM
IRQ 54 ~ IRQ 204	Microsoft ACPI-Compliant System
IRQ 256 ~ IRQ 511	Microsoft ACPI-Compliant System
IRQ 4294967254-69	Intel(R) I210 Gigabit Network Connection
IRQ 4294967292	Intel(R) PCI Express Root Port #6 - 51BD
IRQ 4294967294	PCI Express Root Port
IRQ 4294967271	Intel(R) USB 3.20 eXtensible Host Controller - 1.20 (Microsoft)
IRQ 4294967273-88	Standard NVM Express Controller
IRQ 0	System timer
IRQ 1	Standard PS/2 Keyboard
IRQ 12	Microsoft PS/2 Mouse
IRQ 4294967270	Intel(R) USB 3.10 eXtensible Host Controller - 1.20 (Microsoft)
IRQ 4294967290	Intel(R) PCI Express Root Port #8 - 51BF
IRQ 17	High Definition Audio Controller

C. Watchdog Timer Configuration

The Watchdog Timer (WDT) is used to generate a variety of output signals after a user programmable count. The WDT is suitable for the use in the prevention of system lock-up, such as when software becomes trapped in a deadlock. Under these sorts of circumstances, the timer will count to zero and the selected outputs will be driven.

Under normal circumstance, you will need to restart the WDT at regular intervals before the timer counts to zero.

Sample Code:

```
//-----
//
// THIS CODE AND INFORMATION IS PROVIDED "AS IS" WITHOUT WARRANTY OF ANY
// KIND, EITHER EXPRESSED OR IMPLIED, INCLUDING BUT NOT LIMITED TO THE
// IMPLIED WARRANTIES OF MERCHANTABILITY AND/OR FITNESS FOR A
// PARTICULAR PURPOSE.
//-----
#include <dos.h>
#include <conio.h>
#include <stdio.h>
#include <stdlib.h>
#include "F81964.H"
//-----
int main (int argc, char *argv[]);
void EnableWDT(int);
void DisableWDT(void);
//-----
int main (int argc, char *argv[])
{
    unsigned char bBuf;
    unsigned char bTime;
    char **endptr;

    char SIO;

    printf("Fintek 81964 watch dog program\n");
    SIO = Init_F81964();
    if (SIO == 0)
    {
        printf("Can not detect Fintek 81964, program abort.\n");
        return(1);
    }//if (SIO == 0)

    if (argc != 2)
    {
        printf(" Parameter incorrect!!\n");
        return (1);
    }

    bTime = strtol (argv[1], endptr, 10);
```

```
printf("System will reset after %d seconds\n", bTime);

if (bTime)
{   EnableWDT(bTime);   }
else
{   DisableWDT();   }
return 0;
}
//-----
void EnableWDT(int interval)
{
    unsigned char bBuf;

    bBuf = Get_F81964_Reg(0x27);
    bBuf &= (~0x0C);
    bBuf |= (0x08);
    Set_F81964_Reg(0x27, bBuf);    //Switch to bank 2

    bBuf = Get_F81964_Reg(0x2A);
    bBuf &= (~0x70);
    bBuf |= (0x60);
    Set_F81964_Reg(0x2A, bBuf);    //Select WDTRST# function

    Set_F81964_LD(0x07);           //Switch to logic device 7
    Set_F81964_Reg(0x30, 0x01);    //Enable timer

    bBuf = Get_F81964_Reg(0xF5);
    bBuf &= (~0x0F);
    bBuf |= 0x52;
    Set_F81964_Reg(0xF5, bBuf);    //Count mode is second

    Set_F81964_Reg(0xF6, interval); //Set timer

    bBuf = Get_F81964_Reg(0xFA);
    bBuf |= 0x01;
    Set_F81964_Reg(0xFA, bBuf);    //Enable WDTO output

    bBuf = Get_F81964_Reg(0xF5);
    bBuf |= 0x20;
    Set_F81964_Reg(0xF5, bBuf);    //Start counting
}
//-----
void DisableWDT(void)
{
    unsigned char bBuf;

    Set_F81964_LD(0x07);           //switch to logic device 7

    bBuf = Get_F81964_Reg(0xFA);
    bBuf &= ~0x01;
    Set_F81964_Reg(0xFA, bBuf);    //disable WDTO output

    bBuf = Get_F81964_Reg(0xF5);
    bBuf &= ~0x20;
```

```

    bBuf |= 0x40;
    Set_F81964_Reg(0xF5, bBuf);    //disable WDT
}
//-----

//-----
//
// THIS CODE AND INFORMATION IS PROVIDED "AS IS" WITHOUT WARRANTY OF ANY
// KIND, EITHER EXPRESSED OR IMPLIED, INCLUDING BUT NOT LIMITED TO THE
// IMPLIED WARRANTIES OF MERCHANTABILITY AND/OR FITNESS FOR A
// PARTICULAR PURPOSE.
//
//-----
#include "F81964.H"
#include <dos.h>
//-----
unsigned int F81964_BASE;
void Unlock_F81964 (void);
void Lock_F81964 (void);
//-----
unsigned int Init_F81964(void)
{
    unsigned int result;
    unsigned char ucDid;

    F81964_BASE = 0x4E;
    result = F81964_BASE;

    ucDid = Get_F81964_Reg(0x20);
    if (ucDid == 0x15)        //Fintek 81964
    {   goto Init_Finish;   }

    F81964_BASE = 0x2E;
    result = F81964_BASE;

    ucDid = Get_F81964_Reg(0x20);
    if (ucDid == 0x15)        //Fintek 81964
    {   goto Init_Finish;   }

    F81964_BASE = 0x00;
    result = F81964_BASE;

Init_Finish:
    return (result);
}
//-----
void Unlock_F81964 (void)
{
    outportb(F81964_INDEX_PORT, F81964_UNLOCK);
    outportb(F81964_INDEX_PORT, F81964_UNLOCK);
}
//-----
void Lock_F81964 (void)

```

```
{
    outportb(F81964_INDEX_PORT, F81964_LOCK);
}
//-----
void Set_F81964_LD( unsigned char LD)
{
    Unlock_F81964();
    outportb(F81964_INDEX_PORT, F81964_REG_LD);
    outportb(F81964_DATA_PORT, LD);
    Lock_F81964();
}
//-----
void Set_F81964_Reg( unsigned char REG, unsigned char DATA)
{
    Unlock_F81964();
    outportb(F81964_INDEX_PORT, REG);
    outportb(F81964_DATA_PORT, DATA);
    Lock_F81964();
}
//-----
unsigned char Get_F81964_Reg(unsigned char REG)
{
    unsigned char Result;
    Unlock_F81964();
    outportb(F81964_INDEX_PORT, REG);
    Result = inportb(F81964_DATA_PORT);
    Lock_F81964();
    return Result;
}
//-----
```

F81964.H

```
//-----
//
// THIS CODE AND INFORMATION IS PROVIDED "AS IS" WITHOUT WARRANTY OF ANY
// KIND, EITHER EXPRESSED OR IMPLIED, INCLUDING BUT NOT LIMITED TO THE
// IMPLIED WARRANTIES OF MERCHANTABILITY AND/OR FITNESS FOR A
// PARTICULAR
// PURPOSE.
//
//-----
#ifndef F81964_H
#define F81964_H 1
//-----
#define F81964_INDEX_PORT (F81964_BASE)
#define F81964_DATA_PORT (F81964_BASE+1)
//-----
#define F81964_REG_LD 0x07
//-----
#define F81964_UNLOCK 0x87
#define F81964_LOCK 0xAA
//-----
unsigned int Init_F81964(void);
void Set_F81964_LD(unsigned char);
```

```
void Set_F81964_Reg(unsigned char, unsigned char);  
unsigned char Get_F81964_Reg(unsigned char);  
//-----  
#endif //F81964_H
```

D. Power Control Bit

Function	Connector	Software Mapping
M.2 Key E	J4	Bit_0
USB 3.2	CN18	Bit_1