

VT-840A User's Manual



with Android 11

Rugged Vehicle Mount Terminal

2023/12/4 Ver: 1.1

Table of Contents

Chapter1. About This Manual	1
1.1 Introduction	1
1.2 Precautions and safety	1
1.3 Recycling & disposal instructions	2
1.4 Regulatory information	2
1.5 Product Labeling	2
1.6 Product application scenaio	2
Chapter2. Description of Product	3
2.1 VT-840A	3
2.2 General View of the VT-840A	4
2.3 System Specifications	6
2.4 Environment Standard	7
Chapter3. Function Using	8
3.1 Key Operation	8
3.2 Display Settings	11
3.3 Serial Port	12
3.4 Wireless LAN	13
3.5 Bluetooth	15
3.6 4G/5G	19
3.7 GPS	24
3.8 Power and ACC	29
Chapter4. Packing and Precautions	42
4.1 Check the package	42
4.2 Installation	45
4.3 Jumpers	46
4.4 FAQ	47

Chapter1. About This Manual

1.1 Introduction

This is a user manual about VT-840A, which mainly includes introduction, application environment of the product, description of appearance, product characteristics, technical parameters, setting of common functions, machine installation, matters needing attention and after-sales common problem diagnosis. This manual is designed to help users solve problems encountered in the process of use, please be sure to read this manual in detail, so as to better use the VT-840A.

1.2 Precautions and safety

- Before using the VT-840A, be sure to read the tablet's instructions carefully and follow the instructions.
- Never use strong pressure onto the screen or subject it to severe impact, as the LCD panel could become cracked and possibility cause personal injury. If the LCD panel is broken, never touch the liquid inside because the liquid irritates the skin.
- Although the VT has passed the test of IP65 standard for water and dust resistance, avoid prolonged exposure to rain or other concentrated moisture. Such condition exceeds the IP65 standard, and could result in water or other contaminants entering into the VT.
- Use only the original approved AC/DC Adapter with the VT. Use of an unapproved AC/DC Adapter could result in electrical problems, or even cause a fire or electrical
- Do not disassemble the VT. Servicing should be done by supplier only. If the VT or accessories gets damaged due to wrong handling or unauthorized repair, warranty is void. In case the warranty seals are broken, warranty is void too.
- Make regularly back-up of all important data.
- Under no circumstance will supplier be liable for any direct, indirect, consequential or incidental damages arising out of the use or inability to use the hardware and software and/or any data loss, even if supplier has been informed about the possibility of such damages.

1.3 Recycling & disposal instructions.



Do not throw this product in the home waste bin.



1.4 Regulatory information.



For CE, FCC, RoHS and other Document of Conformities, consult the Contact Window of Darveen Computer.

1.5 Product Label

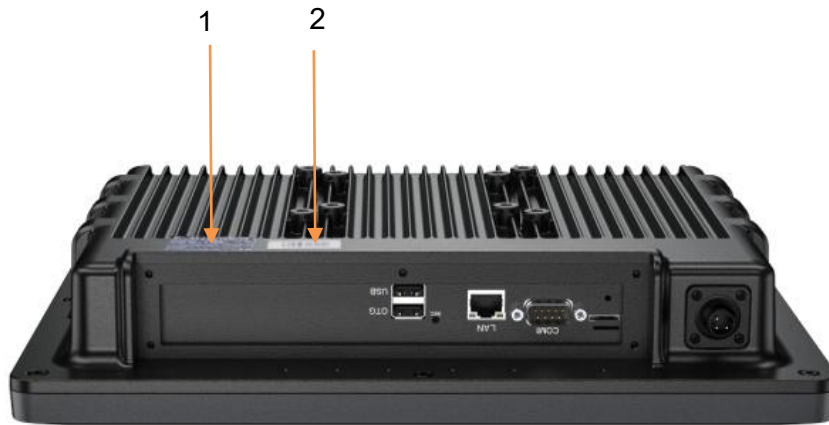

Label nr.	Description
1	Product model name label
2	Serial number label

1.6 Product application scenario

VT-840A is a 12.1-inch multi-touch capacitive screen equipped with a ARM Dual-core A72 + Quad-core A53, up to 1.8GHz and Android 11 operating system. It is designed for warehouse forklift trucks, dock trucks, mining vehicles, agricultural vehicles and other vehicle scheduling management.

Chapter2. Description of Product

2.1 VT-840A

Congratulations on purchasing the VT-840A, VT-840A is a 12.1-inch smart vehicle terminal designed for trucks, RTG, OTG and other applications. All VT products are fanless and wide temperature and wide pressure design. VT-840A is equipped with high-performance 6-core processor, integrated 12.1-inch high-definition touch screen and optional Wi-Fi, 4G/5G, GPS, Bluetooth and other wireless communication to provide real-time communication connection. Support serial port, USB, Ethernet port Extensive interface. Through a special mounting bracket can be easily installed in the vehicle limited space. These features as:

- 12.1-inch(1024x768) LCD with capacitive touchscreen
- High-performance 6-core processor, up to 1.8GHz
- Front panel intergrated numeric and function keys
- Rugged aluminum enclosure and fanless design
- Full IP65 dust/water protection
- Wide range 8-36V DC Power input
- VESA 75 and 100 standard mounting
- Flexible expansion capability for WiFi, Bluetooth, 4G/5G, GPS

2.2 General View of the VT-840A

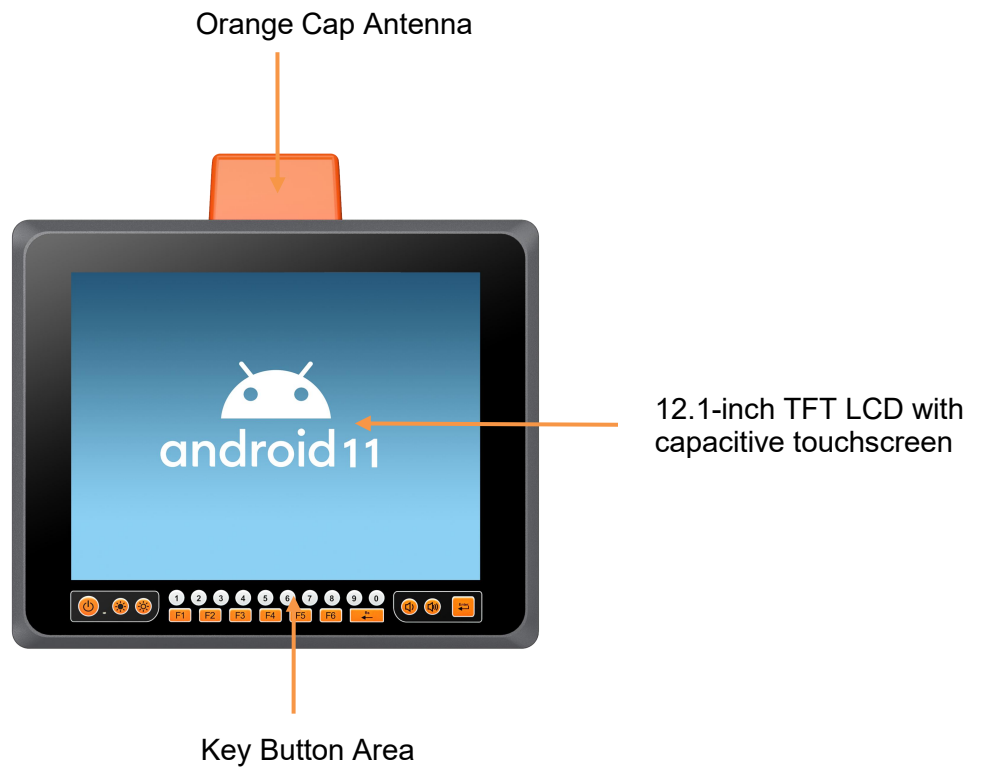

Front view

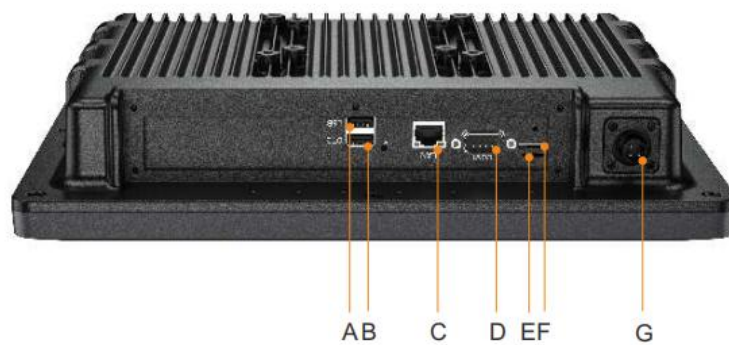

- A: USB
- B: OTG
- C: LAN
- D: COM1
- E: SIM
- F: TF-CARD
- G: DC Power Inlet



Back view



Power Supply Connector

Pin	Signal	Description
1	V In+	DC Input+ (8-36 VDC)
2	ACC Ignition	ACC Delay Ignition Switch
3	V In-	DC Input-

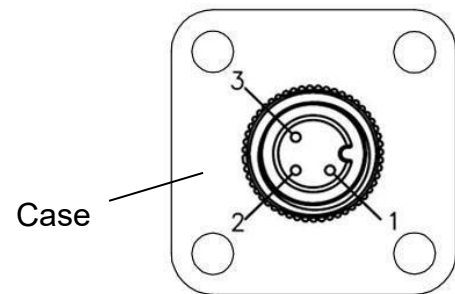

2.3 System Specifications

The VT-840A detailed specifications as follows. Unless otherwise noted, all the specifications are subject to change without prior notification.

VT-840A	
Processor	ARM Dual-core A72 + Quad-core A53, up to 1.8GHz
Memory	- 4GB LPDDR4 RAM - 32GB EMMC Flash Memory
Storage	1 x TF Card, up to 128GB
Operating System	Android 11
Display	- 12.1" TFT LCD with LED backlight - SVGA 1024 x 768 Resolution - 500cd/m ² Brightness
Touch Panel	- Capacitive
Input / Output Ports	- 1 x RS-232 - 1 x USB - 1 x USB/OTG - 1 x 1000M RJ45 - 1 x Nano-SIM
Audio	- 2 x 8Ω/2W

VT-840A	
WLAN	- 802.11a/b/g/n/ac (2.4G/5G)
WWAN	- 4G LTE FDD/TDD, TD-SCDMA/WCDMA, CDMA/GSM - 5G NR/NSA/SA, LTE FDD/TDD, WCDMA (Optional)
Bluetooth	- Bluetooth V4.2
GPS	- GPS/GLONASS/BeiDou/QZSS/Galileo/SBAS (Optional)
Keypad	- Power on/off, Brightness +/-, Volume +/- - 0-9 Numeric, F1-F6 Function, Enter, Backspace
Power System	- Power Input: 8~36V DC - Power Consumption: 12W typ.
Dimensions and Weight	- Dimensions (L x W x H):320 x 260 x 66 (mm) - Weight: 3.6Kg
Housing and Color	- Aluminum - Black

2.4 Environment Standard

Operating Temperature	-20~60°C
Mounting	VESA 75/100
Humidity	5%-95%, non-condensing
Shock	MIL-STD-810G Method 516.6 Procedure I
Vibration	MIL-STD-810G Method 514.6 Procedure I
Water & Dust proof	IP65 (I/O interface must be closed)

Chapter3. Function Using

3.1 Key Operation

1. Turn on the VT-840A

Press the power button for 2-3 seconds to turn on the VT-840A. If the VT-840A does not power on, check the power supply has been connected normally and you should try again.



Power Button

When the VT-840A is powered on, its operating system starts up. A splash screen of Darveen logo appears for a short period of time followed by the Android system desktop window.

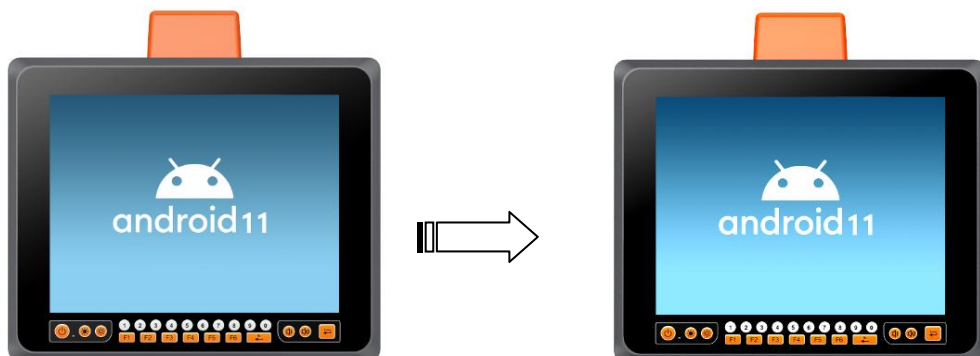

2.Adjust brightness

When the VT-840A is powered on and login Android system ,you can adjust screen brightness and volume manually by pressing the button on the front of VT-840A.



Brightness -



Brightness +



Volume -



Volume +



Label nr.	Description
1	LCD panel protection film
2	Keypad for power on/off, brightness control buttons

3.2 Display Settings

1. Enter the Setting option of the main application menu and click the “**Display**” . you can adjust brightness, resolution and related display settings.

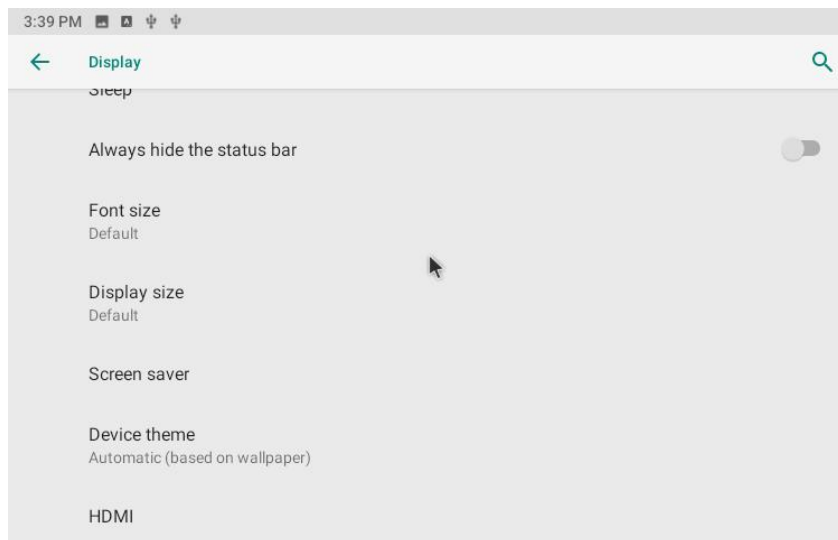
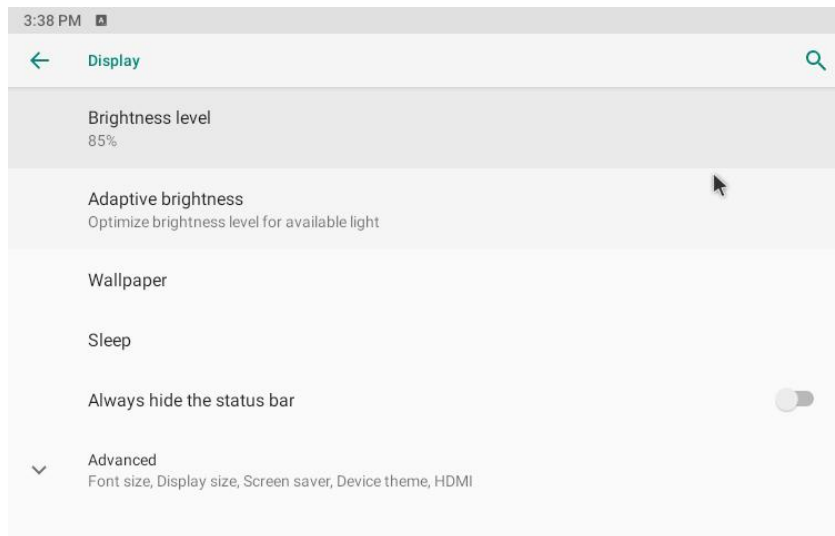

3.3 Serial Port

1. **ComAssistant** is a powerful Android serial port tool, which can be used to communicate with serial ports between two devices. **Comassistant** can be used to set serial port parameters and send and receive data by clicking the application of main menu.

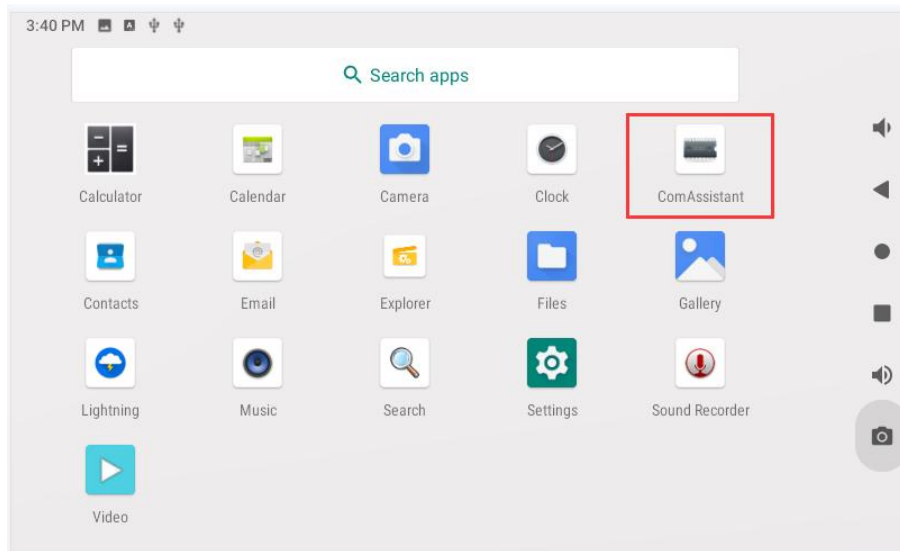

2. After entering **ComAssistant**, select `</dev/ttyS0>`; Baud rate is **9600** by default. Click to change **OFF** to **ON** and the color to green. Then connect to another device via a serial cable, click **Send** and you can transfer data using a serial port.

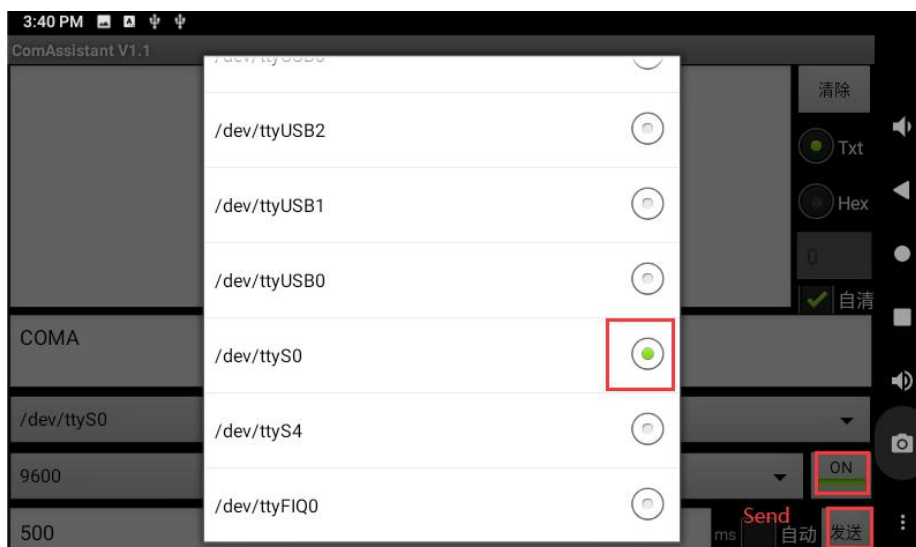

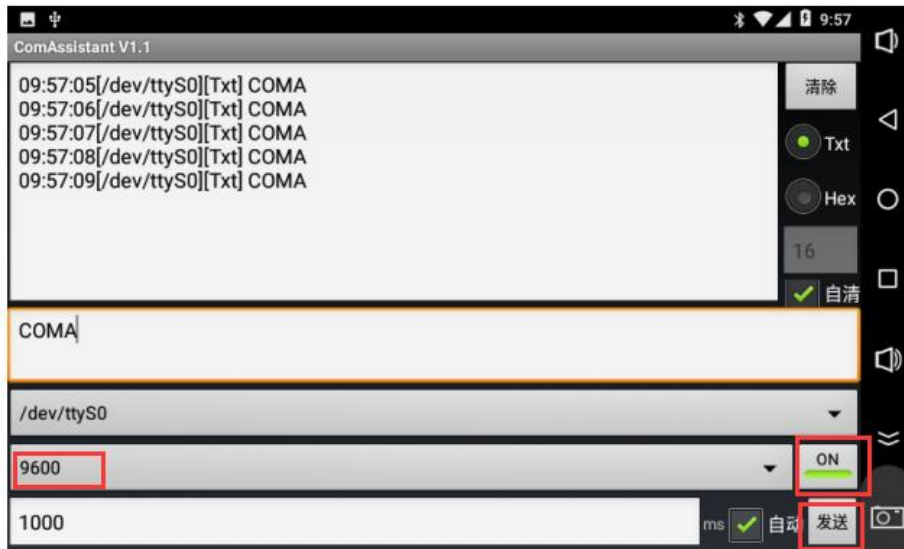

3.4 Wireless LAN

1. Open the main application menu and and Click the “**Settings**”.

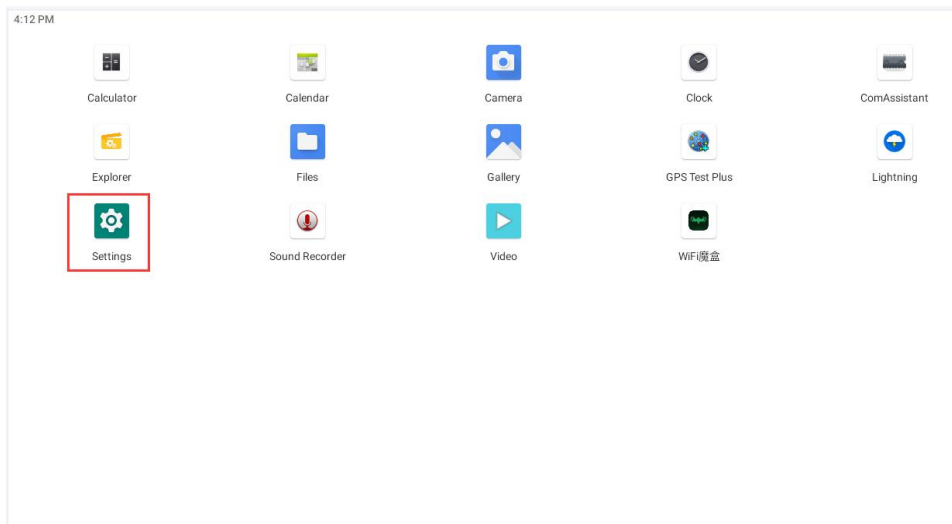

2. Select the **“Network& internet”** option from the **“Settings”** and click the button in the upper right corner to search and view the available wifi networks.

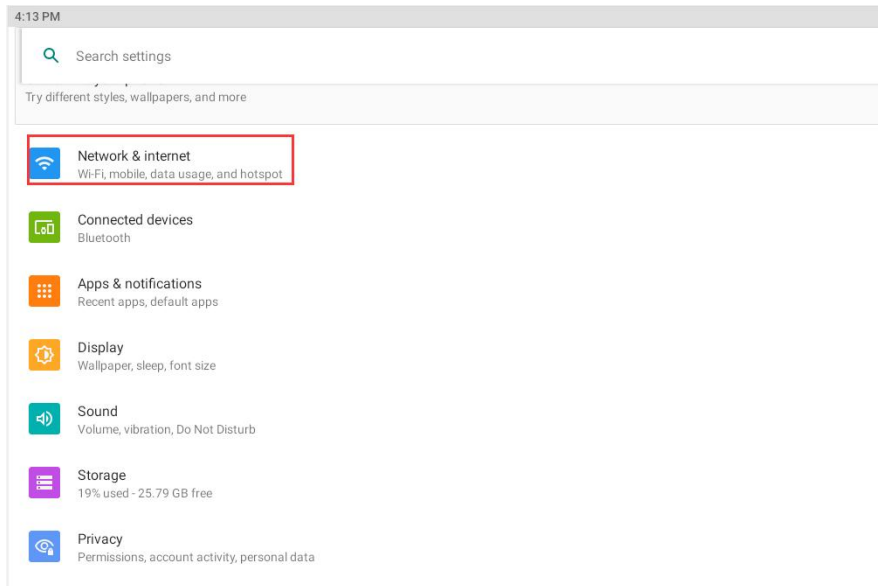

3. Select the wifi network you want to connect to, enter its password and click **“CONNECT”** to complete the wireless network Settings.

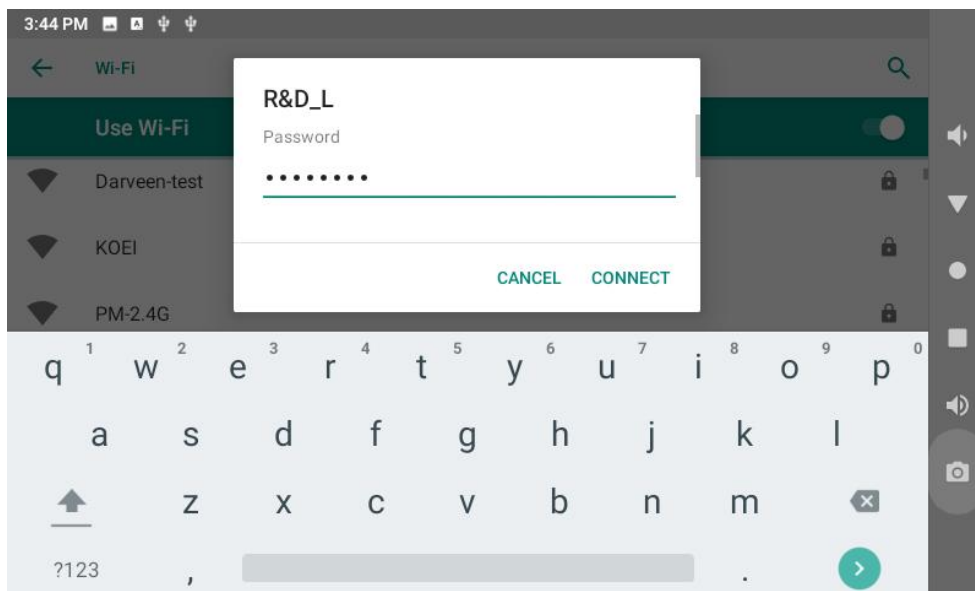

4. Once verified, the WIFI will be connected successfully, shown as below picture.

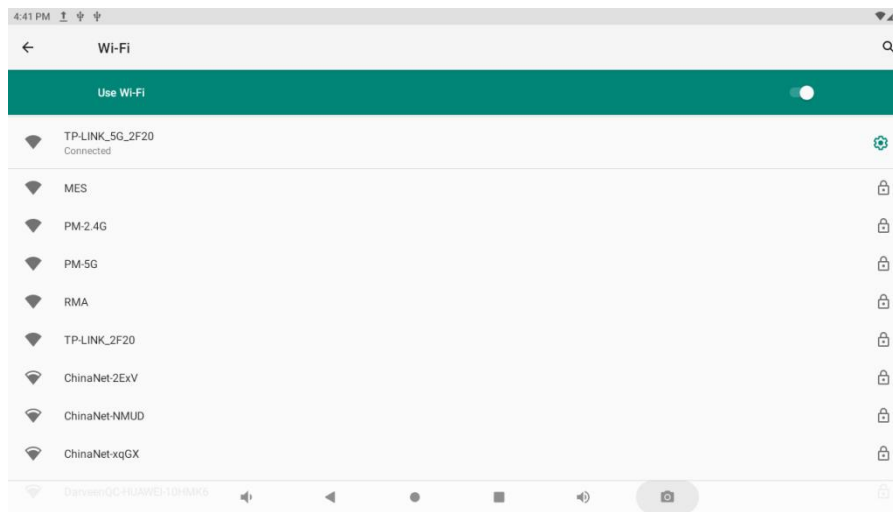

3.5 Bluetooth

1. Open the main application menu and click the **“Settings”**.
2. Turn on your Bluetooth device and make it discoverable.
3. Select the **“Bluetooth”** option from the **“Setting”** and click the button in the upper right corner to search and pair new devices.

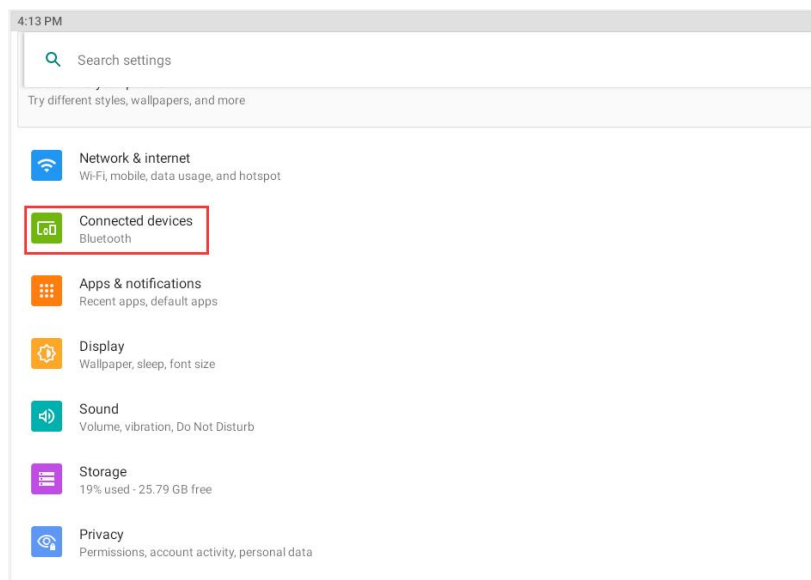

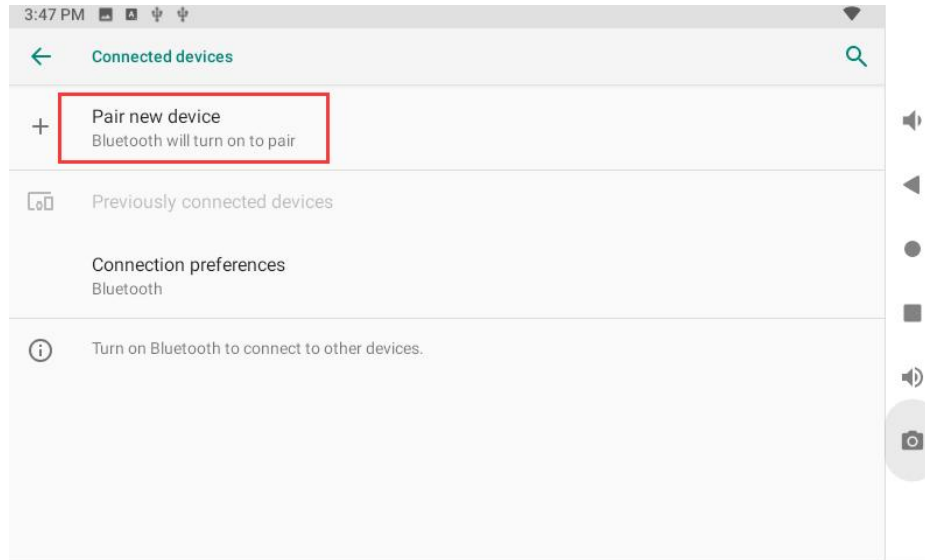

4. Click on the Bluetooth device you want to connect to and pair it. You will see the pairing password pop up in the image below.

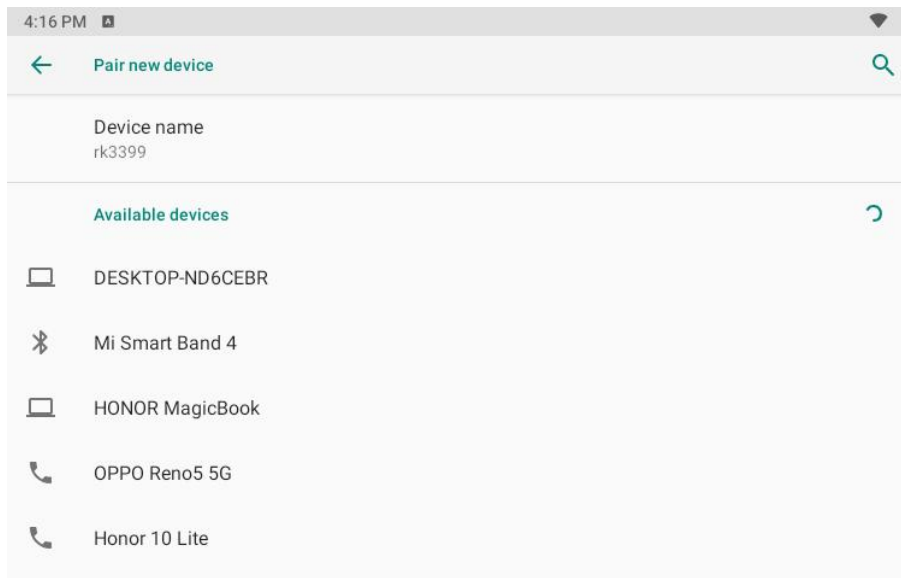

5. Ensure the pairing password on VT-840A and the device you want to connect to are the same. It helps you ensure you're connecting the device to the correct machine, and not another nearby device.

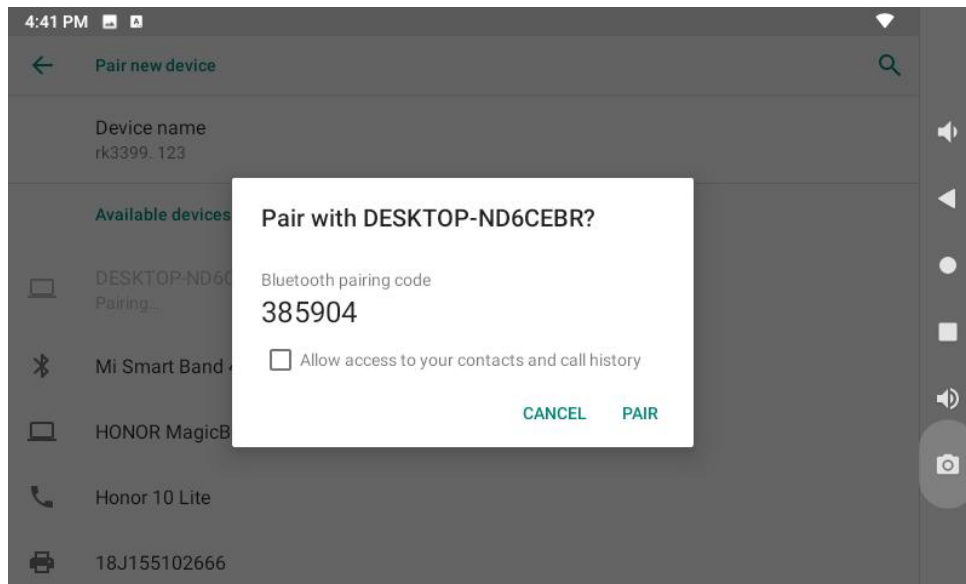

6. Select the "Available Devices" to view previously connected Bluetooth devices.

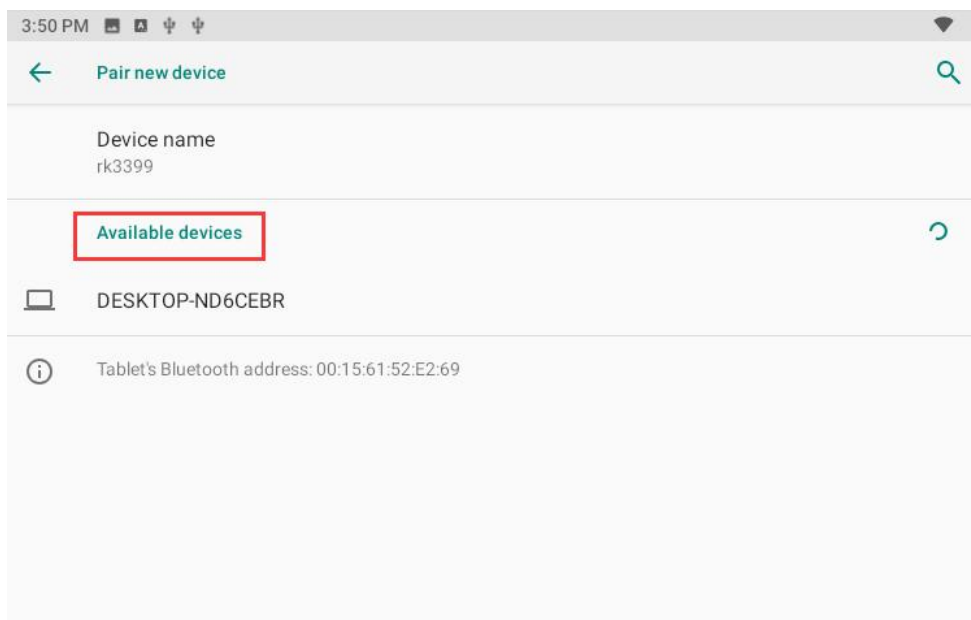

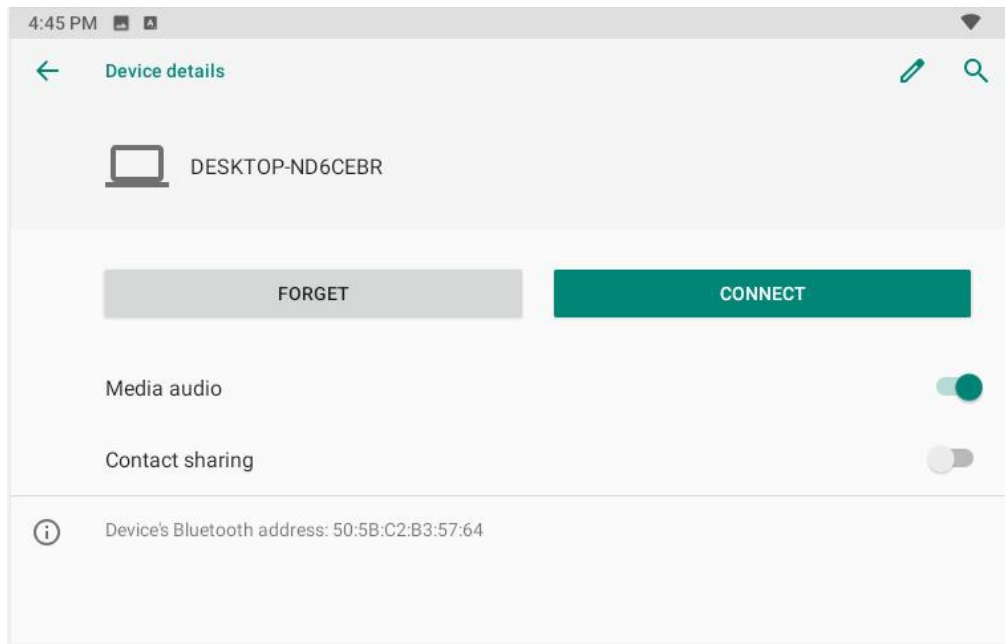
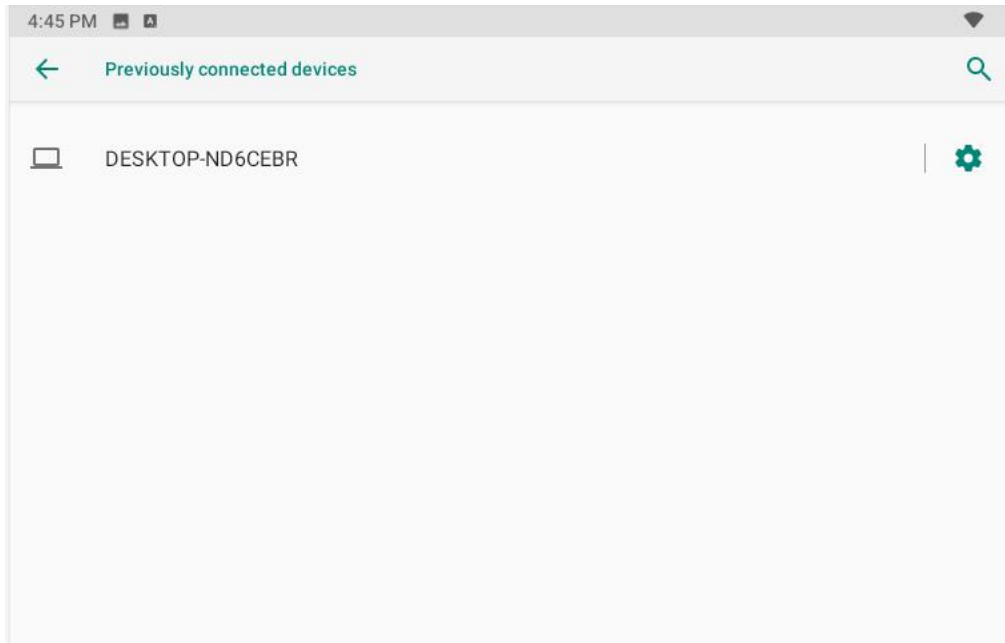

When the Bluetooth connection is set up, you can transfer files between the two devices.

3.6 4G/5G

1.Insert 4G/5G SIM card into VT-840A. The SIM card is standard size. SIM slot position is as follows.



Note: Please ensure that the machine is completely powered off before inserting and removing the SIM card.

After installing SIM card, if the network can be connected normally, the installation is completed.If not, manually input the corresponding APN access points of SIM card operators.

2.Open the main application menu and and choose the “**Setting**”.Click on the“**Network & internet**”,choose the“**Mobile network**” .

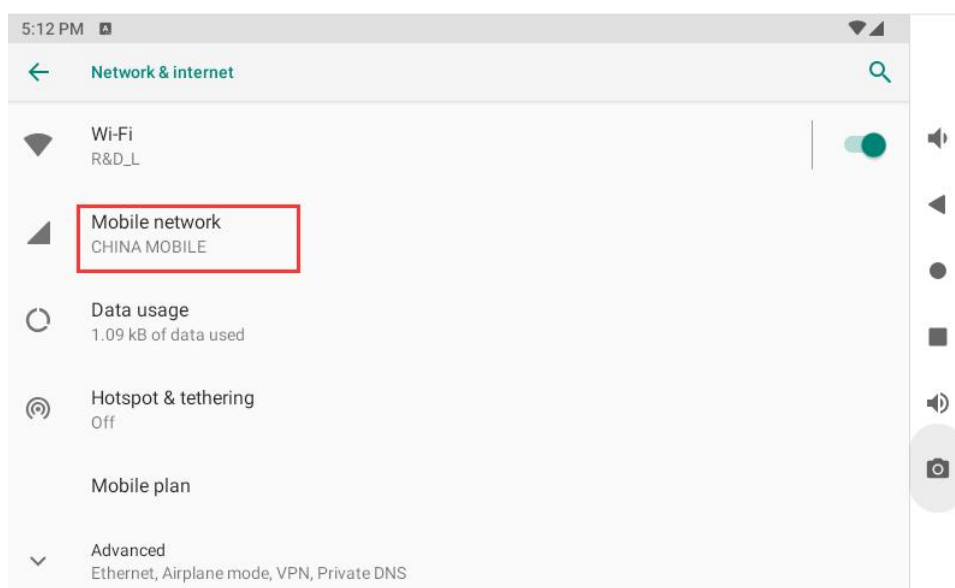

3. Turn on the " Mobile Data ".

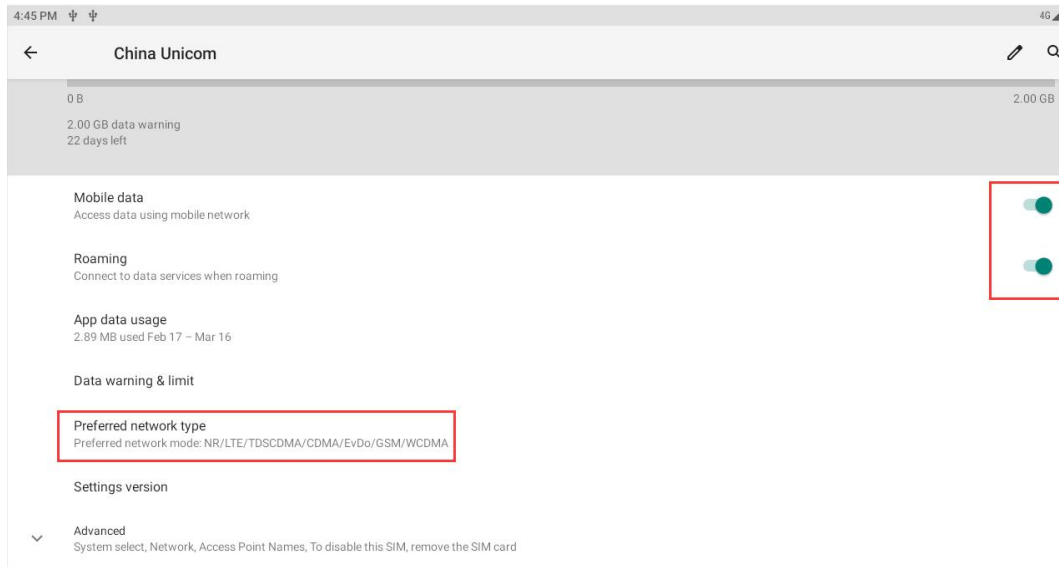

4. Click on "Preferred network type" and select the "NR/LTE/TDSCDMA/CDMA/EvDo/GSM/WCDMA" network type from the Cellular network settings interface.

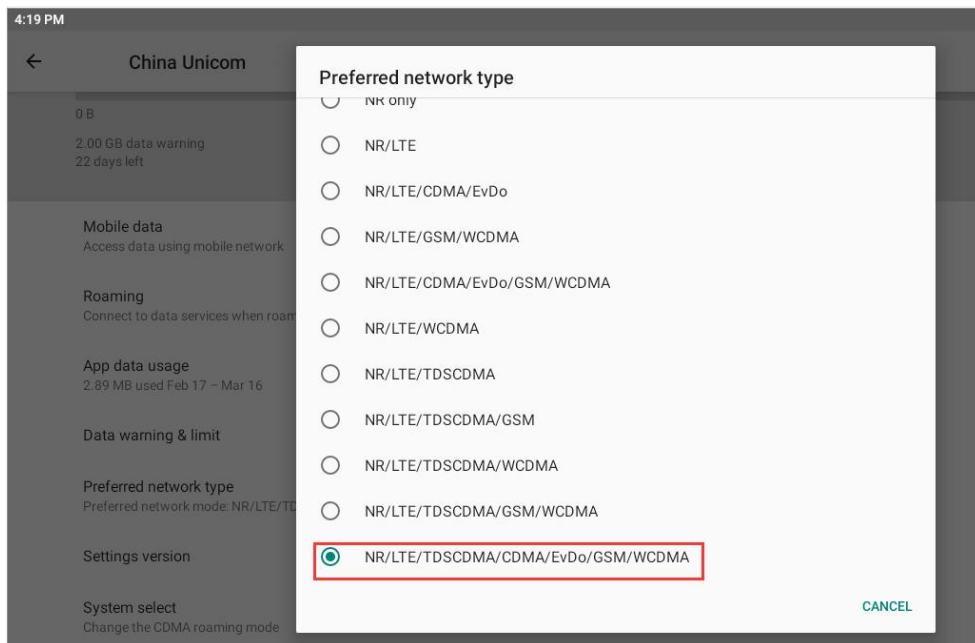

5. Click on “**Access Point Names**” option and select APN corresponding to SIM card in APN list. In China, China Mobile is **cmnet**, China Unicom is **3gnet** and China Telecom is **ctnet**.

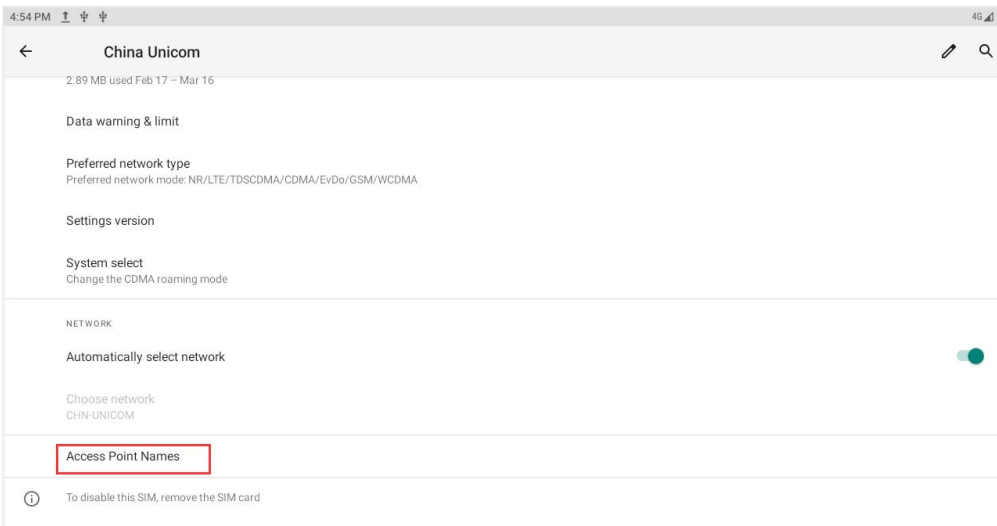
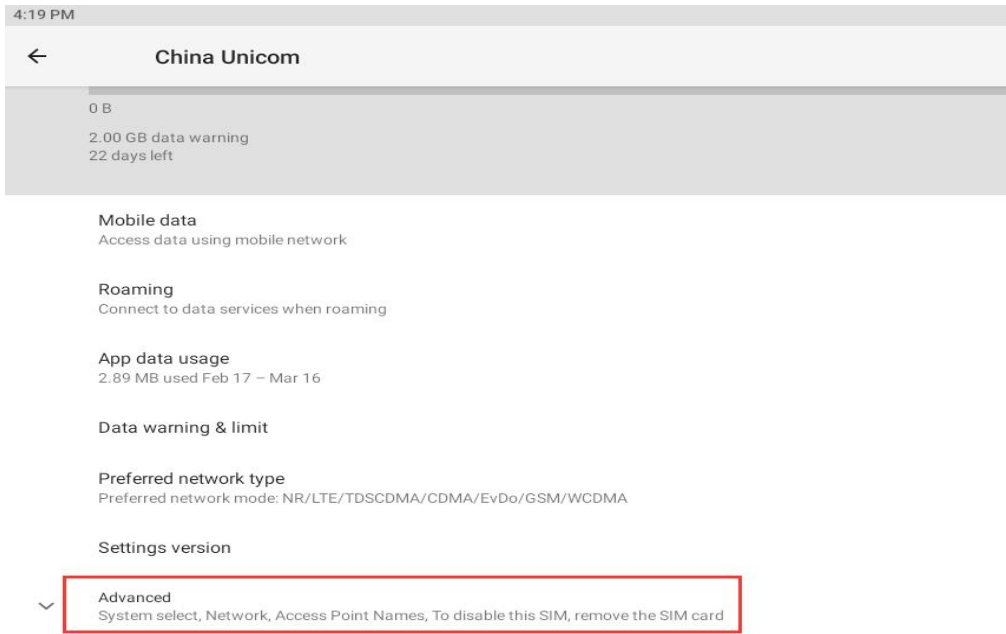

6.If you want to change the APN configuration information, you can double-click the name of the APN in the list.However, unlike China Mobile and China Unicom, sim cards of China Telecom are not automatically connected to the default APN, so we need to add new APN manually by click the "+" symbol in the top right corner.

7.In the “Edit access point” interface, enter the custom name and APN of China Telecom(**CTNET**).Then click the“**save**”option in the top right corner. Finally,you can select China Telecom's APN (**CTNET**) from the saved APN list.

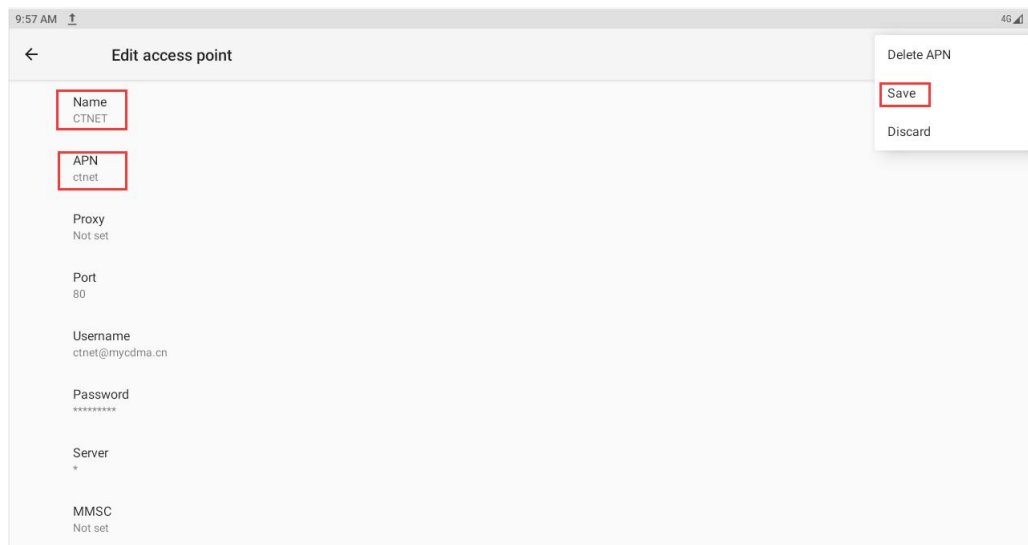

8. To make sure you're connected to 4G/5G, you can pull down the signal status bar above the VT-840A desktop.

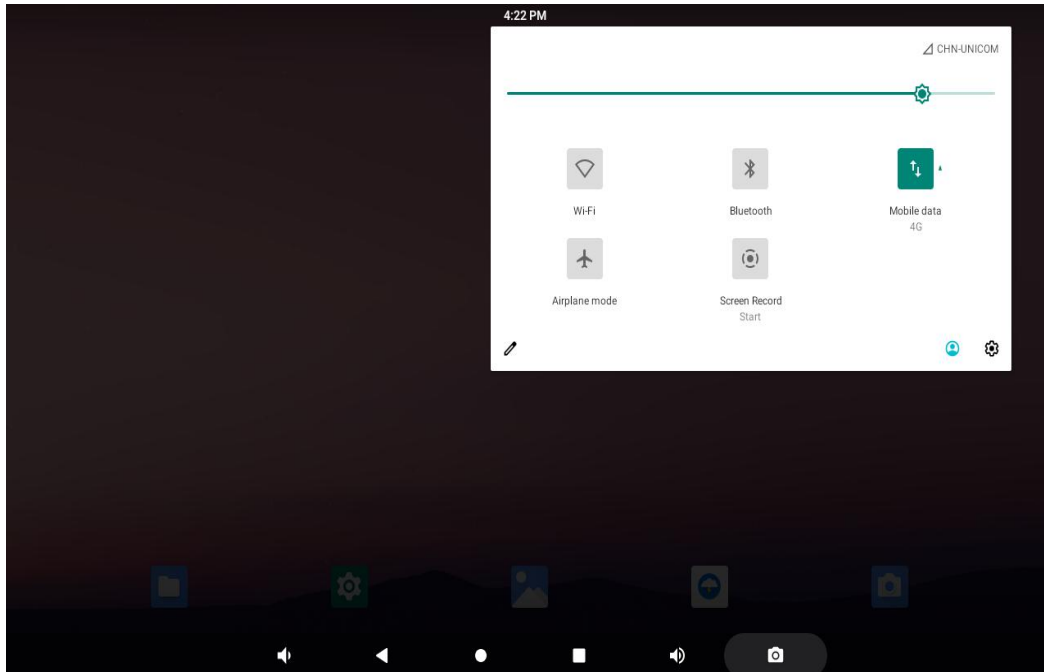

3.7 GPS

1. Install GPS antenna to VT-840A. You can buy antennas with better signals. Install those on the antenna interface.

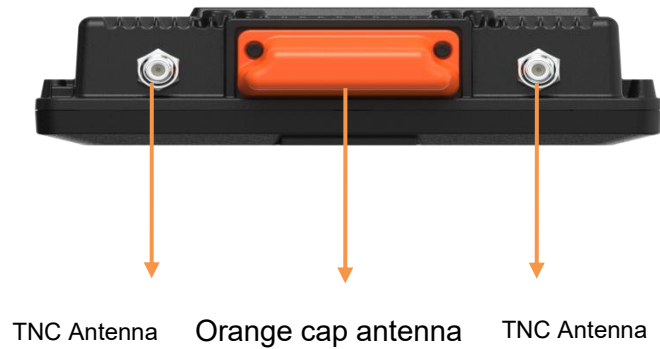

2. VT-840A is commonly used in GPS Test Plus for GPS positioning. GPS Test Plus is an easy to use Android GPS real-time positioning tool, it supports automatic detection of GPS in the history of Android devices, automatic search satellite, can also display the current dimensions, longitude, elevation, movement speed, the compass, the global time zones, sunrise and sunset, and historical sites and the distance from the center of the current direction information.

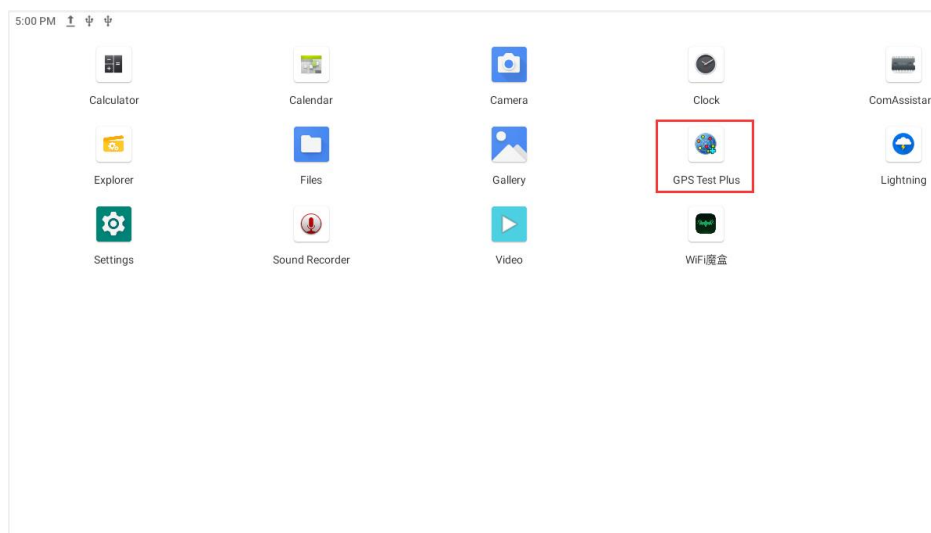

3. Before turning on **GPS Test Plus**, go to the “**Setting**”, select “**Location**”.

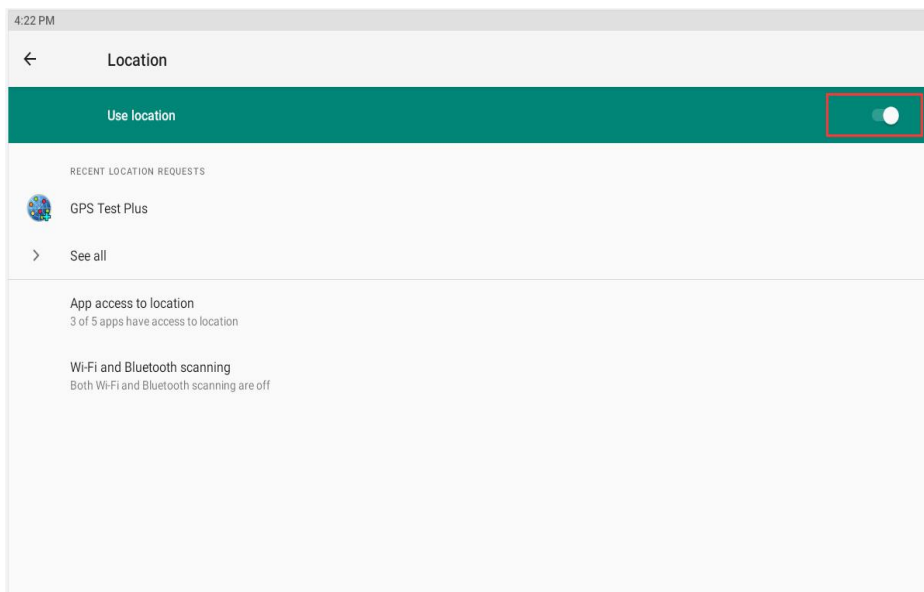
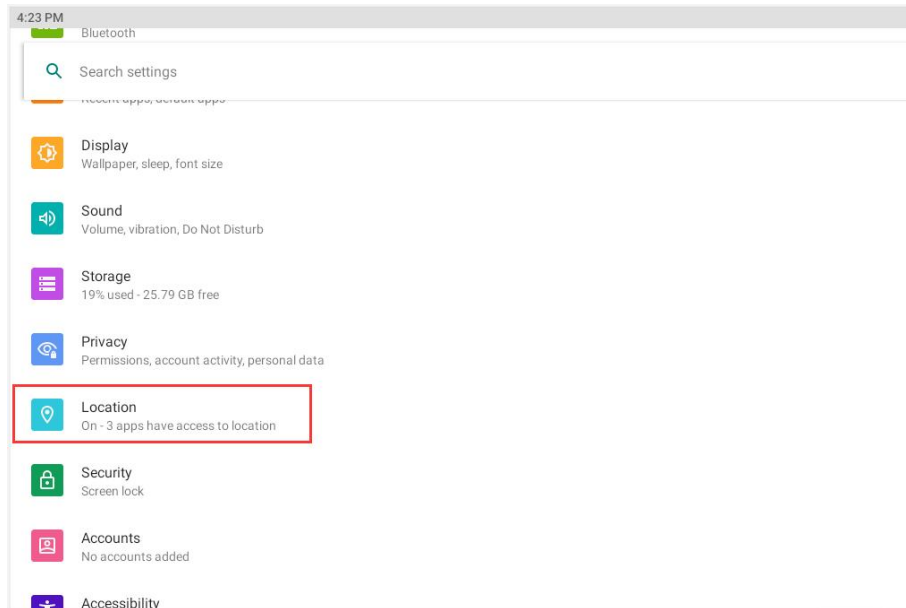

4. GPS positioning is best done outdoors in open areas. After the above preparations are completed, enter the GPS Test Plus for the first GPS signal positioning. As can be seen from the figure below, the first location information can be saved by clicking the indication option below. GPS signal (SNR) bar chart showing the signal strength of each satellite, as well as the accuracy and GPS status.

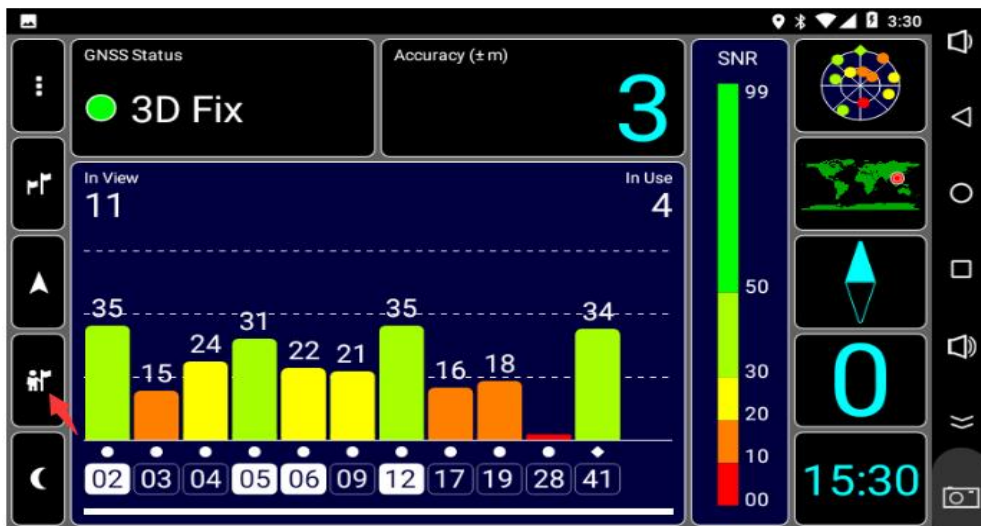

5. GPS Test Plus is provided by a variety of navigation systems, including Beidou in China, GPS in the United States, Glonass in Russia and QZSS in Japan.



6. Not only can you get information about your current speed, heading and altitude from it, but it also has a compass function.

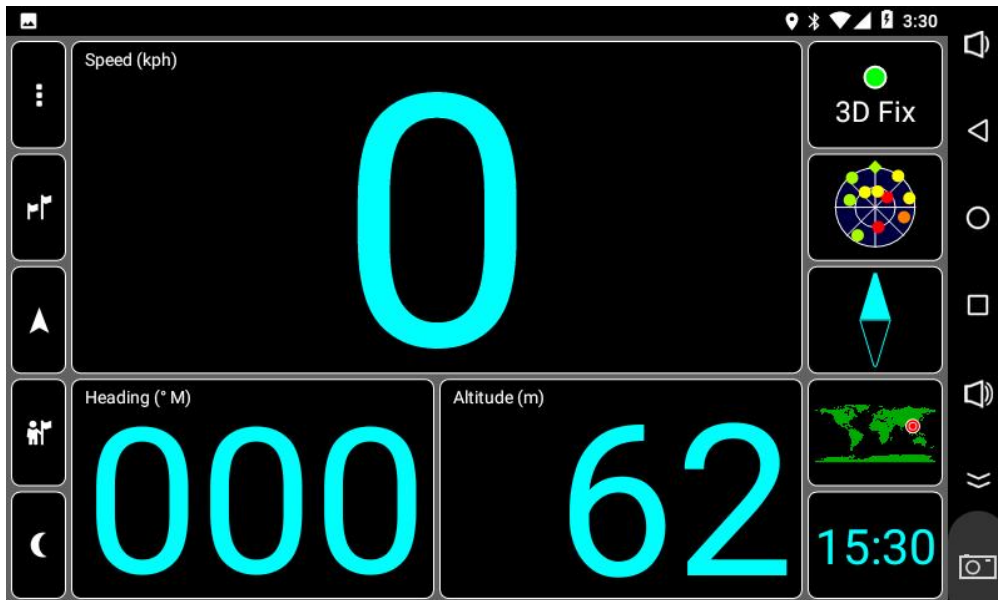

7. It can display sunrise, sunset, altitude, direction, UTC time and other information. Satellites in the sky can be displayed by a rotating compass.

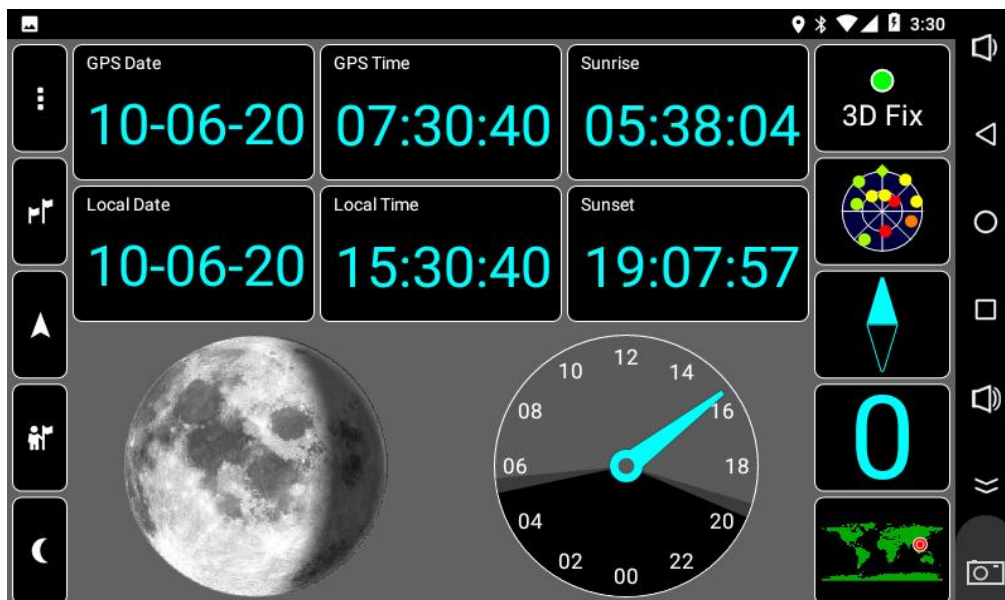

8.The following table shows the saved GPS positioning details, including latitude and longitude, accuracy,Grid,Datum,altitude and time.

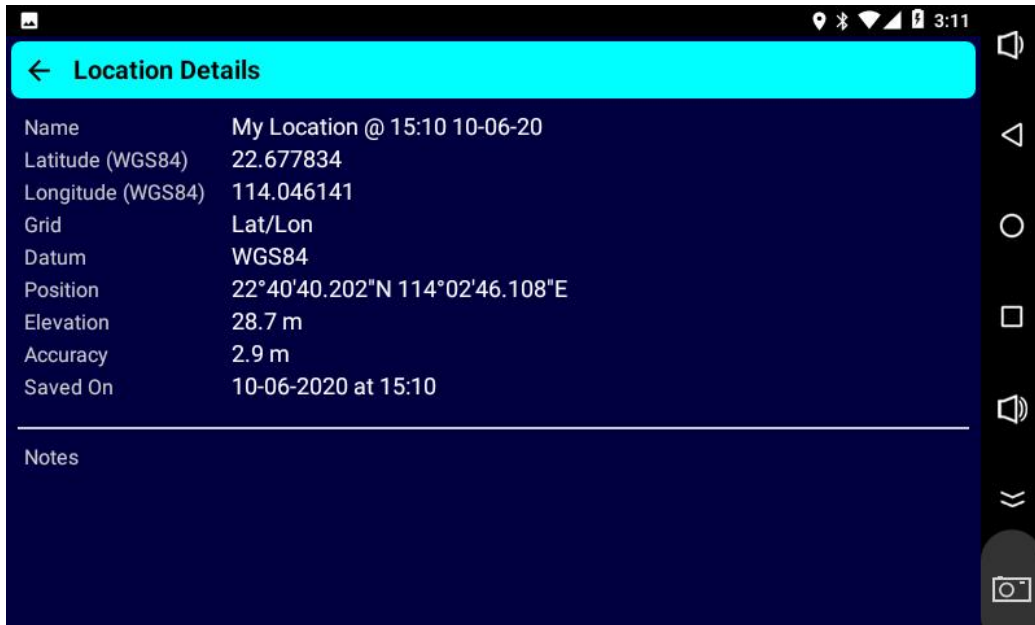

3.8 Power and ACC

1. Power option

Power is supplied to the VT-840A through the power connector. Additionally this assembly provides a connection point for the vehicle's chassis ground to be connected internally to the conductive chassis of the computer. The VT-840A internal power supply can accept DC input voltages in the range of 8 to 36 Volts DC.

Before using the VT-840A, choose different power adapters for different vehicle power.

Power Options including:

- **12 VDC Vehicles** (8-36VDC Direct Connection) – Direct connection to vehicle power.
- **24 VDC Vehicles** (8-36VDC Direct Connection) – Direct connection to vehicle power.
- **48 VDC Vehicles** – Requires the use of a DC-DC power supply.
- **80 VDC Vehicles** – Requires the use of a DC-DC power supply.
- **External AC/DC Power Supply** – For use when DC power supply is not available to power the VT-840A, such as in an office environment.

2. Power Cable Identification

PC-03M-20-ACC

Power cable with **straight connector** and **4 wires**, **2 meters** long:

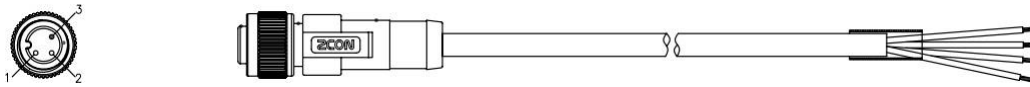

M12 Connector	Wire Color	Connection
P1	Red	DC+ (8-36 VDC)
P2	Yellow Green	Ignition Input (Optional)
P3	Black	DC-
Case	Black	Ground

Note: PC-03M-20-ACC cable is use for direct connection from vehicle power to VT-840A or DC-DC power input.

PC-23MM-20

Power cable with **straight connector**, **2 meters** long:

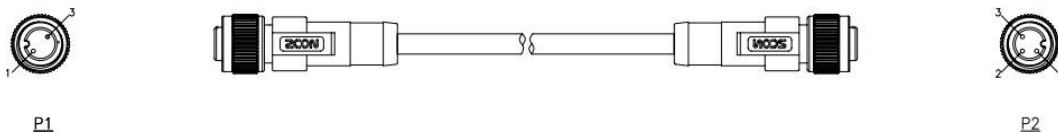

M12 Connector(P1)	M12 Connector(P2)	Connection
P1	P1	DC+ (8-36 VDC)
(NC)	P2	Ignition Input (Optional)
P3	P3	DC-
Case	Case	Ground

Note: PC-23MM-20 cable is use for connection from VT-840A to DC-DC power output, just without power ignition function.

PC-23MM-20-ACC

Power cable with **straight connector** and **1 wire**, **2 meters** long:

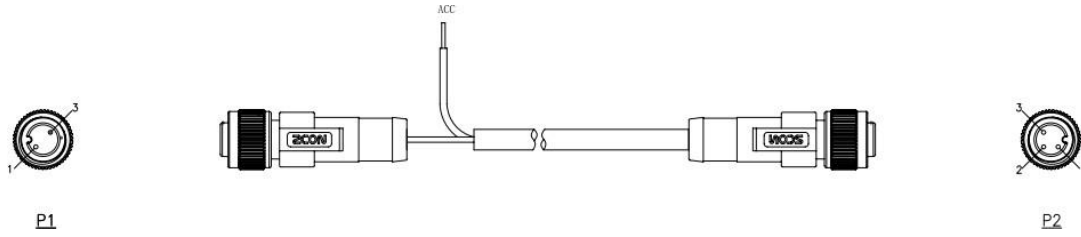

M12 Connector(P1)	M12 Connector(P2)	Connection
P1	P1	DC+ (8-36 VDC)
(Yellow)	P2	Ignition Input (Optional)
P3	P3	DC-
Case	Case	Ground

Note: PC-23MM-20 cable is use for connection from VT-840A to DC-DC power output, also with power ignition function.

3.External Power Adapter Options

(1) External AC-DC Power Supply PWR220A12-M12

The optional external AC/DC power supply is for use in environments, such as an office, where DC power is not available.

PWR220A12-M12 is support 100V-240V ac input, provide 12V dc and 5A power output, the power connector is an M12 male type which can meet IP65 dust and water proof.

Note: The Darveen-approved AC/DC Power Supply and Adapter Cable are only intended for use in a 25°C (77°F) maximum ambient temperature environment.

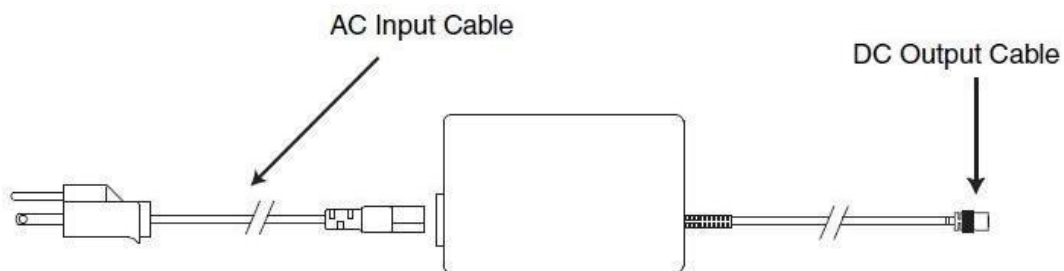

Connect External AC/DC Power Supply

1. Connect the provided detachable cord set (all others must order cable separately) to the external power supply.
2. Plug cord set into appropriate, grounded, electrical supply receptacle (AC mains).
3. Connect the watertight connector end of the Adapter Cable to the VT-840A Power Connector by aligning the connector pins to the power connector; push down on the watertight connector and twist it to fasten securely.
4. Press the Power Button on the front of the VT-840A to turn on the VT-840A.

(2) External DC-DC Power Supply PWR836D512-M12

PWR836D512-M12 is an optional external DC/DC power supply, that is for use in vehicles provided 12V dc or 24V dc power. The power input and output connectors are M12 male type which can meet IP65 dust and water proof.

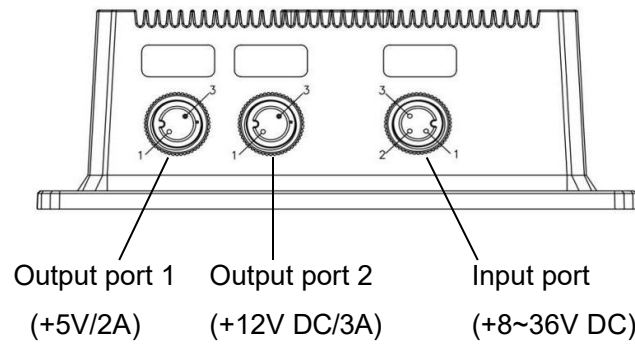

Input Port		Output Port 1		Output Port 2	
Pin	Signal	Pin	Signal	Pin	Signal
1	DC In+ (8-36 VDC)	1	DC Out+ (5V/2A)	1	DC Out+ (12V/3A)
2	NC	3	DC Out-	3	DC Out-
3	DC In-				

PWR3672D512-M12

PWR3672D512-M12 is an optional external DC/DC power supply, that is electronic isolation for use in the vehicles provided 48V dc power. The power input and output connectors are M12 male type which can meet IP65 dust and water proof.

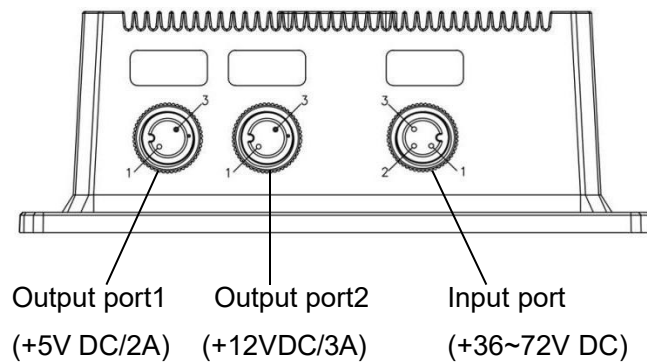

Input Port		Output Port 1		Output Port 2	
Pin	Signal	Pin	Signal	Pin	Signal
1	DC In+ (36-72V DC)	1	DC Out+ (5V/2A)	1	DC Out+ (12V/3A)
2	NC	3	DC Out-	3	DC Out-
3	DC In-				

12-24V DC Vehicles (8-36V DC Direct Connection)



•Fuse Requirements:

•**WARNING** - For proper and safe installation, the input power cable must be connected to a fused circuit on the vehicle. If the supply connection is made directly to the battery, the fuse should be installed in the positive lead within 5 inches of the battery's positive (+) terminal. The fused circuit requires a maximum time delay (slow blow) fuse with a current rating as noted below.

• For **12V DC** input, use a 10A slow blow fuse that has a DC voltage rating greater than 12V DC.

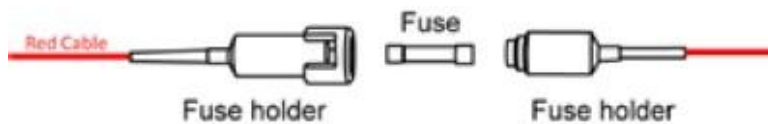

• For **24V DC** input, use a 6A slow blow fuse that has a DC voltage rating greater than 24V DC.

1. Connected vehicle directly.

(1) Use the ignition ON/OFF function.

Connect the watertight connector end of the power cable to the VT-840A power connector by aligning the connector pins to the power connector, push down on the watertight connector and twist it to fasten securely.

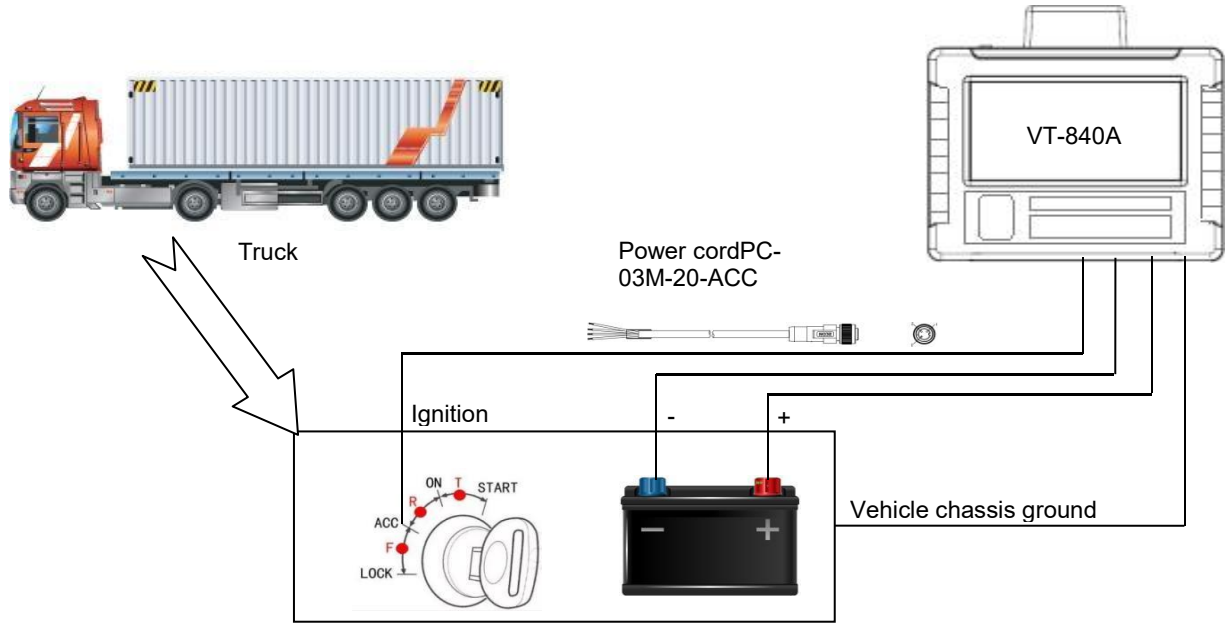

(2) Without the ignition ON/OFF function.

- a. Cut off the yellow wire (Ignition wire) on the power cord (PN: PC-03M-20-ACC);
- b. Connect the watertight connector end of the power cable to the VT-840A power connector by aligning the connector pins to the power connector, push down on the watertight connector and twist it to fasten securely.

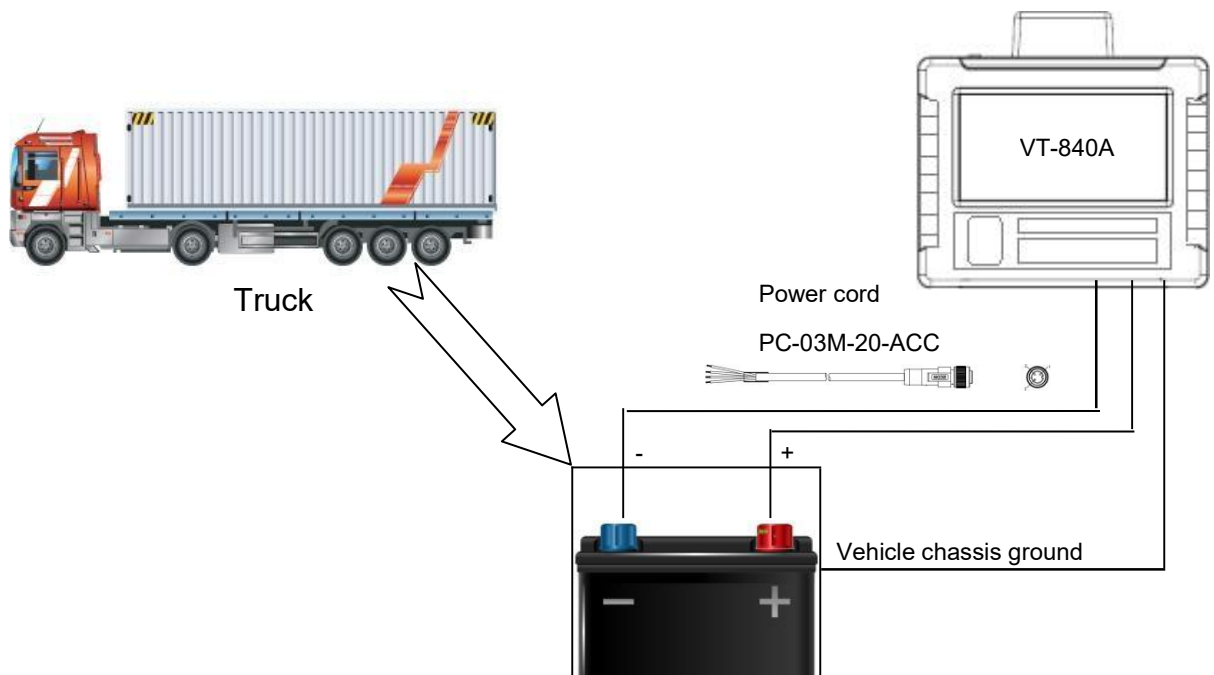

2. Connected vehicle via DC-DC power adapter.

(1) Use the ignition ON/OFF function.

- a. Connect the watertight connector end of the power cable (PC-03M-20-ACC) to the PWR836D512-M12 power connector by aligning the connector pins to the power connector, push down on the watertight connector and twist it to fasten securely.
- b. Connect the watertight connector end of the power cable (PC-23MM-20-ACC) to VT-840A and PWR836D512-M12, then connect the yellow wire (ignition wire) to the vehicle ignition signal pin.

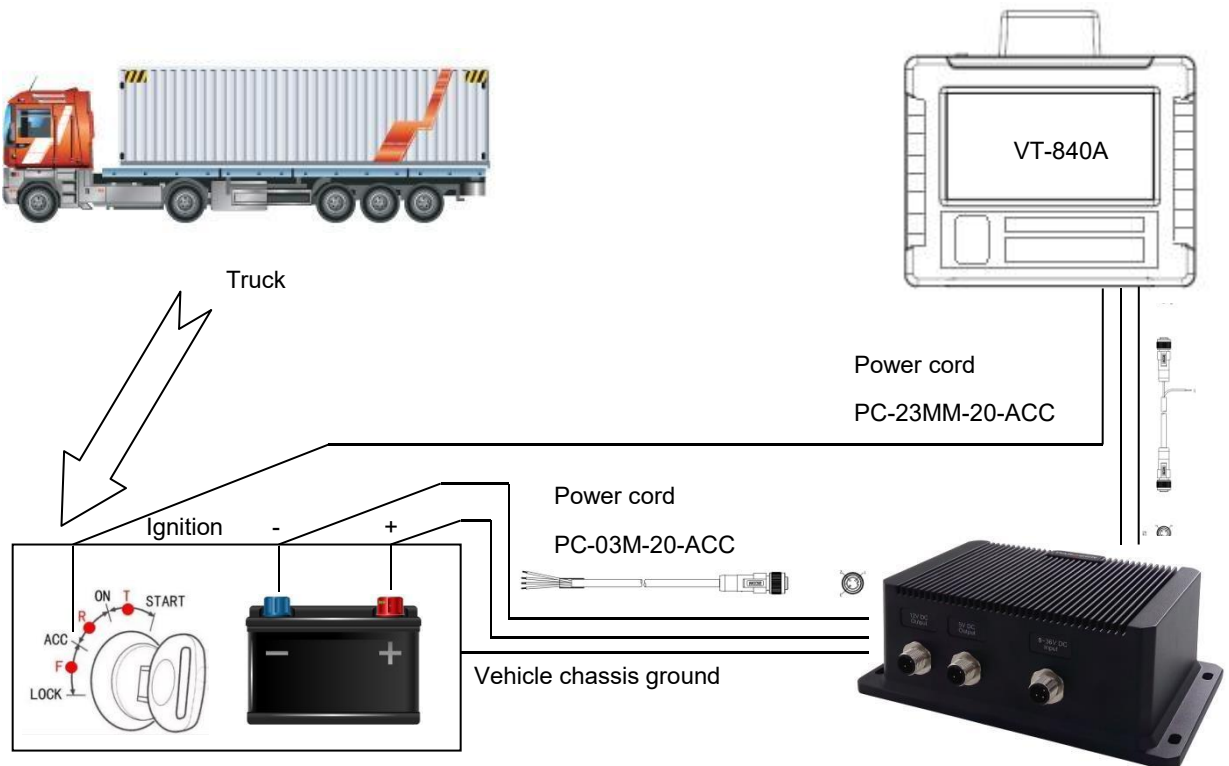

(2) Without the ignition ON/OFF function.

- a. Cut off the yellow wire (Ignition wire) on the power cord (PN: PC-03M-20-ACC);
- b. Connect the watertight connector end of the power cable (PC-03M-20-ACC) to the PWR836D512-M12 power connector by aligning the connector pins to the power connector, push down on the watertight connector and twist it to fasten securely.
- c. Connect the watertight connector end of the power cable (PC-23MM-20) to VT-840A and PWR836D512-M12.

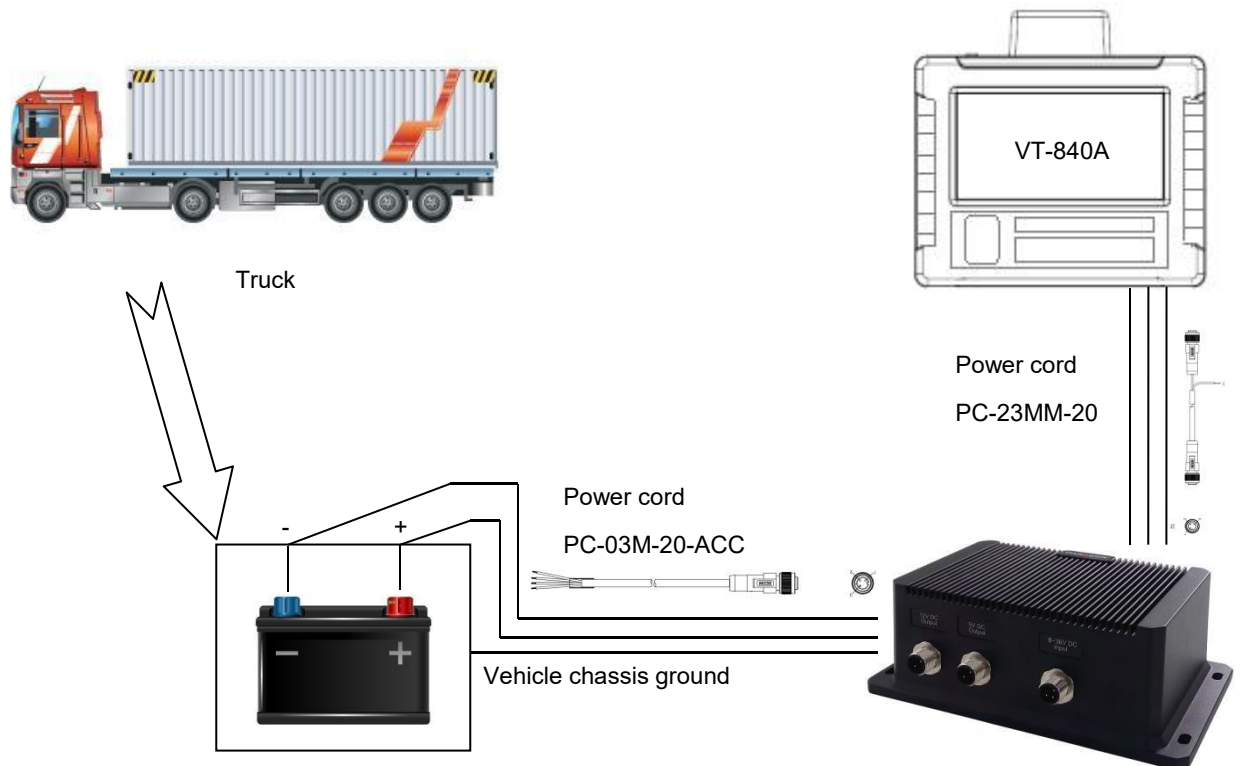

48V DC Vehicles (Connected via DC/DC power)



- Fuse Requirements:
- WARNING** - For proper and safe installation, the input power cable must be connected to a fused circuit on the vehicle. If the supply connection is made directly to the battery, the fuse should be installed in the positive lead within 5 inches of the battery's positive (+) terminal. The fused circuit requires a maximum time delay (slow blow) fuse with a current rating as noted below.
- For **48VDC** input, use a 3A slow blow fuse that has a DC voltage rating greater than 48VDC.

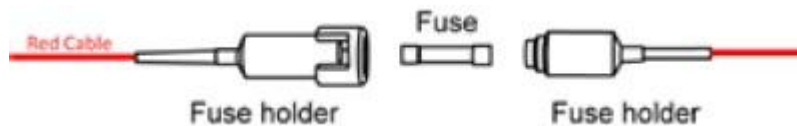

1. Use the ignition ON/OFF function.

- a. Connect the watertight connector end of the power cable (PC-03M-20-ACC) to the PWR3672D512-M12 power connector by aligning the connector pins to the power connector, push down on the watertight connector and twist it to fasten securely.
- b. Connect the watertight connector end of the power cable (PC-23MM-20-ACC) to VT-840A and PWR3672D512-M12, then connect the yellow wire (ignition wire) to the vehicle ignition signal pin.

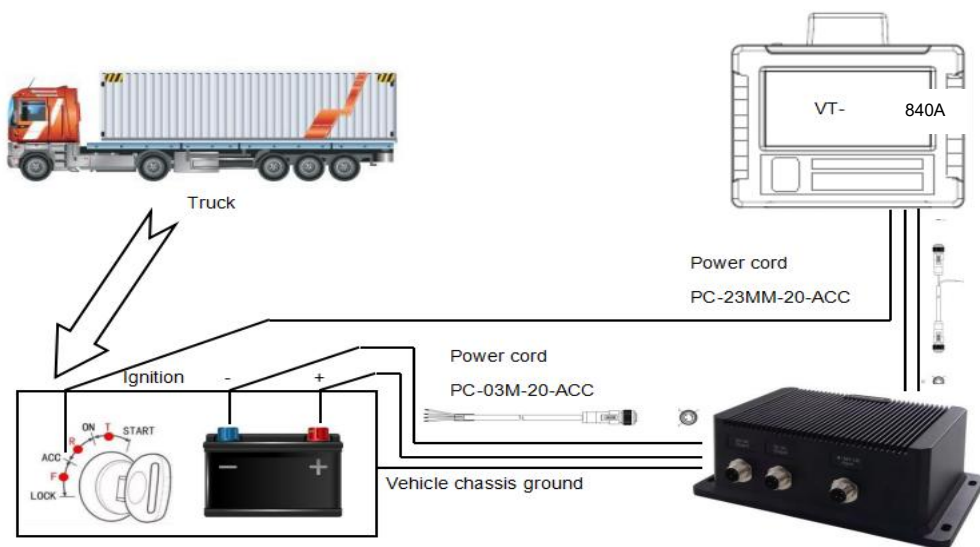

2. Without the ignition ON/OFF function.

- a. Cut off the yellow wire (Ignition wire) on the power cord (PN: PC-03M-20-ACC);
- b. Connect the watertight connector end of the power cable (PC-03M-20-ACC) to the PWR3672D512-M12 power connector by aligning the connector pins to the power connector, push down on the watertight connector and twist it to fasten securely.
- c. Connect the watertight connector end of the power cable (PC-23MM-20) to VT-840A and PWR3672D512-M12.

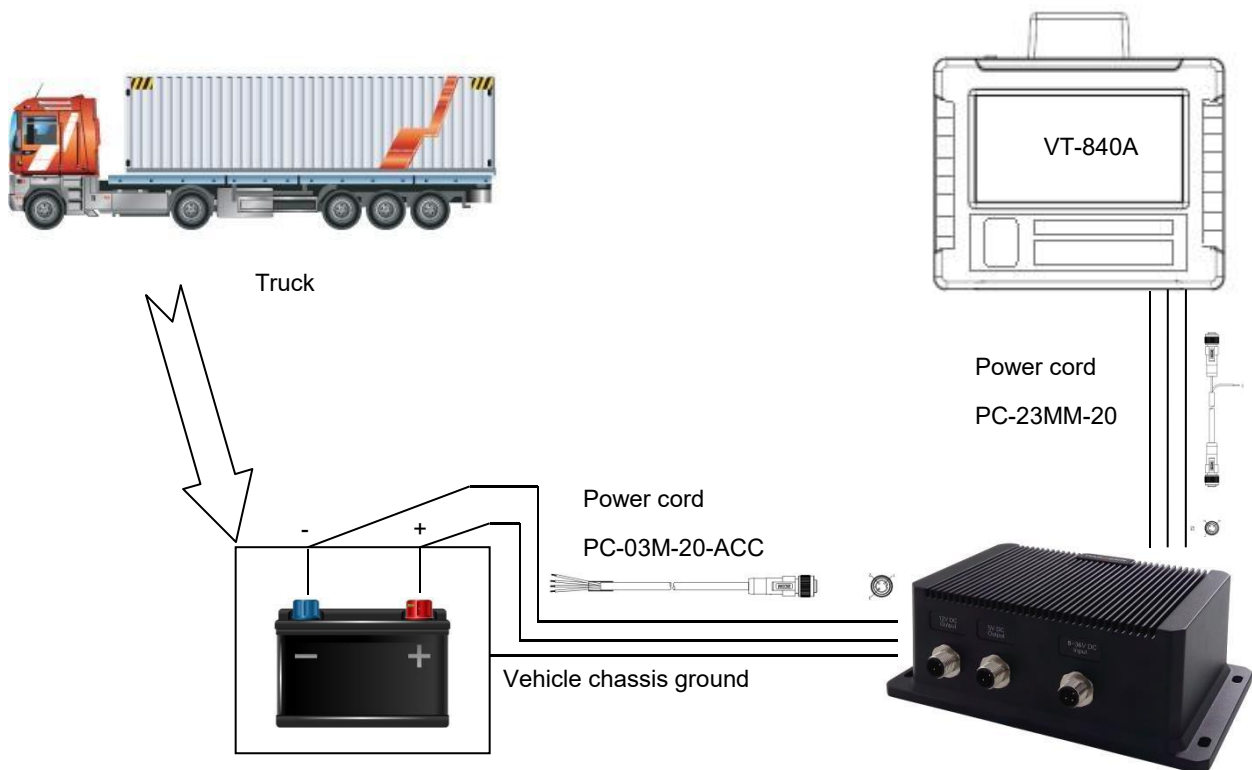



Chapter4. Packing and Precautions

4.1 Check the package

Thank you for your trust in purchasing our products. When you receive the products, please make sure that the outer packing of the products is in good condition. In case of any appearance damage or missing accessories, please contact your distributor





A.VT-840A (Main Unit)

Standard package is including a VT-840A main unit and a power cable.









1	Main unit	VT-840A	
2	Power cable	PC-03M-20-ACC	

B.Accessories (Optional)

According to the use of different environment, you can choose some different parts, the list is as below:

1	Power Adapter	PWR220A12-M12 * AC-DC Adapter * 100~240Vac Input, 12V/5A dc Output	
2		PWR836D512-M12 * DC-DC Adapter * 8~36Vdc Input, 12V/3A and 5V/2A Output	
3		PWR3672D512-M12 * DC-DC Adapter * 36~72Vdc Input, 12V/3A and 5V/2A Output	
4	Mounting Kits	RAM-MOUNT-02 * Universal Adjustable * Marine Grade Aluminum * VESA Standard (75x75mm and 100x100mm)	

5		<p>DV-MOUNT-1002</p> <ul style="list-style-type: none"> * Forklift Roof Mounting Kits * Universal Adjustable * Marine Grade Aluminum * VESA Standard (75x75mm and 100x100mm) 	
6		<p>DV-MOUNT-2002</p> <ul style="list-style-type: none"> * Forklift U-shaped Mounting Kits * Universal Adjustable * Marine Grade Aluminum * VESA Standard (75x75mm and 100x100mm) 	
7		<p>DV-MOUNT-60</p> <ul style="list-style-type: none"> * Lifting Mounting Kits * Stainless Steel Material * Lifting Height Adjustable Range 50~100cm * VESA Standard Holes(75x75mm & 100x100mm) 	
8	Power cable	PC-03M-20-ACC	
9		PC-23MM-20	
10		PC-23MM-20-ACC	
11	Antenna	<p>Rubber Duck Antenna</p> <p>ANT-R3S</p> <p>SMA(Female), 3dB, Universal</p>	
12		<p>Rubber Duck Antenna</p> <p>ANT-R3T</p> <p>TNC(Female), 3dB, Universal</p>	

13		<p>Rubber Duck Antenna ANT-R4T TNC(Female), 2~4dB, Cisco</p>	
14		<p>Magnetic Mount Antenna ANT-S7S SMA(Female), 7dB, 5meters long</p>	
15		<p>Magnetic Mount Antenna ANT-S7T TNC(Female), 7dB, 5meters long</p>	
16		<p>Fiberglass Antenna ANT-G5N N(Female), 5dB, 0.3meters long</p>	
17		<p>GPS Antenna ANT-GPSS SMA(Female), 3meters cable, GPS</p>	
18		<p>GPS Antenna ANT-GPST TNC(Female), 3meters cable, GPS</p>	
19		<p>GPS Antenna ANT-GNSSS SMA(Female), 3meters cable, GPS&GNSS</p>	
20		<p>GPS Antenna ANT-GNSST TNC(Female), 3meters cable, GPS&GNSS</p>	
21	Industrial Keyboard	<p>DKB-70 * 70 Keys QWERTY Full-function Keyboard * LED Backlight, Independent Switch Control * F1-F20 Function Keys, 0-9 Numeric and A-Z Alpha</p>	

22		<p>Keyboard Mounting Bracket BK-VT1</p>	
----	--	---	---

4.2 Installation

VT-840A is mainly used in container terminals and yards, mining cars, logistics in manufacturing yards, warehouse management forklifts, heavy vehicles, etc. In order to adapt to its working environment, it has a variety of installation and fixing methods, including boom installation, VESA fixed installation, wall-mounted installation and so on.



The splint bracket customized by Dawen is installed and equipped with RAM universal bracket according to the model. Customers can adjust the orientation of the bracket according to their own requirements, making the operation more flexible and convenient. This bracket is easy to disassemble and install, and easy to maintain later.

4.3 Jumpers

Cards can be configured by setting jumpers. A jumper is a metal bridge used to close an electric circuit. It consists of two metal pins and a small metal clip (often protected by a plastic cover) that slides over the pins to connect them. To close a jumper, you connect the pins with the clip. To open a jumper, you remove the clip. Sometimes a jumper will have three pins, labeled 1, 2 and 3. In this case you would connect either pins 1 and 2, or 2 and 3.

The jumper settings are schematically depicted in this manual as follows.

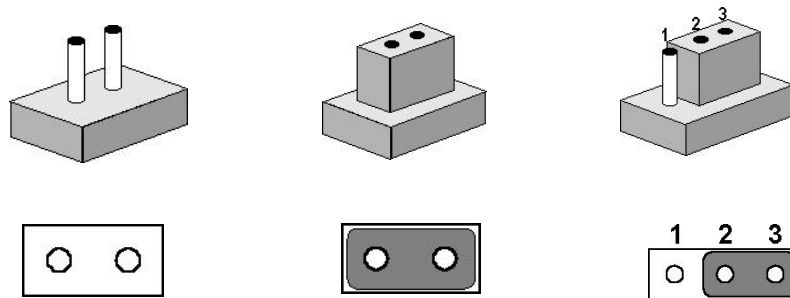

A pair of needle-nose pliers may be helpful when working with jumpers. If you have any doubts about the best hardware configuration for your application, contact your local distributor or sales representative before you make any changes. Generally, you simply need a standard cable to make most connections.

4.4 FAQ

Q1: Does the on-board terminal support ACC ignition signal delay switch?

A: VT-840A car terminal optional ACC ignition signal intelligent switch machine functions. Under the function of the ACC mode, when the on-board computer off, if the detected signal when the ACC will automatic startup latency for 10 seconds, and car terminal in the boot state, if detected the ACC will delay 10/30/120 seconds after the automatic shutdown, without artificial operation in the process of the on-board computer;

When ACC is selected, the power interface of the on-board terminal will be changed to 3Pin, positive pole, negative pole, ACC detection pole. Generally, positive and negative pole are connected to vehicle batteries, and ACC detection pole is connected to ignition signal.

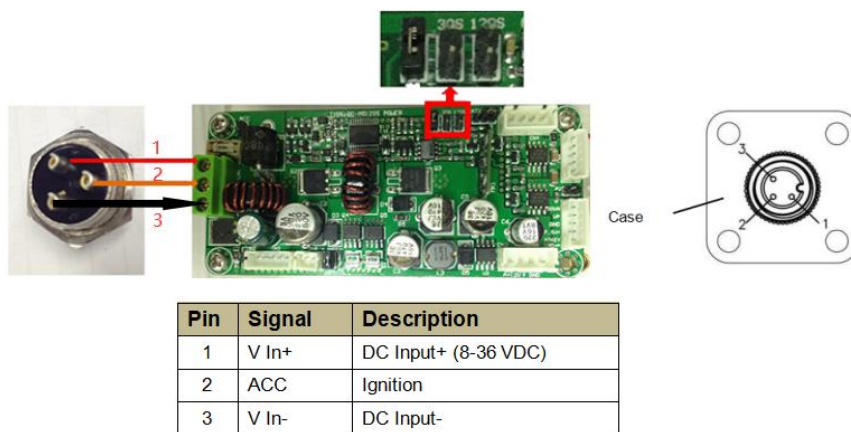

Q2: Why is it necessary to add a DC-DC power adapter for the installation of forklifts, trailers, front cranes and stacker?

A: The car always has a peak value at startup. In order to avoid burning out the equipment power board, the power adapter of DC-DC is needed to stabilize the voltage. The current equipment installed power board supports the voltage of 8-36V

Description:

For these battery models, there are three voltage output specifications, as follows:

- 1, trailer battery output voltage: 12V
2. Battery output voltage of front lifting and stacking machine: 24V
3. Forklift battery output voltage: 48V

Existing DC-DC power adapters are available in two specifications as follows:

- 1, 9-58 v

2, 18-68 v

Advice:

1, when the battery voltage output is 12V, 24V, choose 9-58V power adapter

2, when the battery voltage output is 48V, choose 18-68V power adapter.

Q3:What advantages does TNC have over SMA antenna interface?

A:TNC interface and feeder connection stability is better, not easy to loose and damage, TNC joint damage rate is low.



TNC interface

SMA interface

Q4: How to ensure the normal use of the VT-840A under the impact of high strength vibration?

A: 1.VT-840A shell is made of strong aluminum alloy.

2.The VT-840A's built-in electronic modules offer excellent shock resistance, such as a gauge LCD screen and a shock-resistant solid-state drive (SSD), enabling the VT-840A to withstand harsh vibration.