

VT-708K User's Manual



with Microsoft[®] Windows[®]
with Ubuntu

Rugged Vehicle Mount Terminal

2023/12/04 Ver: 1.1

Table of Contents

Chapter1. About this Manual	1
1.1 Introduction	1
1.2 User and Product Safety	1
1.3 Recycling & disposal instructions.	2
1.4 Regulatory information.	2
1.5 Product Labeling	2
1.6 Product application scenaio	2
Chapter2. Description of Product	3
2.1 VT-708K	3
2.2 General View of the VT-708K	4
2.3 System Specifications	6
2.4 Environment Standard	7
Chapter3. Function Using	8
3.1 Handling the VT-708K	8
3.2 Configure and calibrate the touch screen	10
3.3 Wireless LAN	16
3.4 Bluetooth (Win10)	36
3.5 Bluetooth (Win7)	42
3.6 4G LTE (Win10)	46
3.7 4G LTE (Win7)	49
3.8 GPS	54
3.9 CAN	63
3.10 Power Management of ACC	65
Chapter4. Accessories and Power connection	68
4.1 Check the package	68
4.2 Power Connection	72
Chapter5. Installation and FAQ	84
5.1 Installation	84
5.2 Jumpers	84
5.3 FAQ	86
5.4 Warranty and after service	88

Chapter1. About this Manual

1.1 Introduction

This is a user manual about VT-708K, which mainly includes introduction, application environment of the product, description of appearance, product characteristics, technical parameters, setting of common functions, machine installation, matters needing attention and after-sales common problem diagnosis. This manual is designed to help users solve problems encountered in the process of use, please be sure to read this manual in detail, so as to better use the VT-708K.

1.2 User and Product Safety

- Never use strong pressure onto the screen or subject it to severe impact, as the LCD panel could become cracked and possibility cause personal injury. If the LCD panel is broken, never touch the liquid inside because the liquid irritates the skin.
- Although the VT has passed the test of IP65 standard for water and dust resistance, avoid prolonged exposure to rain or other concentrated moisture. Such condition exceeds the IP65 standard, and could result in water or other contaminants entering into the VT.
- Use only the original approved AC/DC Adapter with the VT. Use of an unapproved AC/DC Adapter could result in electrical problems, or even cause a fire or electrical shock to the user.
- Do not disassemble the VT. Servicing should be done by supplier only. If the VT or accessories gets damaged due to wrong handling or unauthorized repair, warranty is void. In case the warranty seals are broken, warranty is void too.
- Make regularly back-up of all important data.
- Under no circumstance will supplier be liable for any direct, indirect, consequential or incidental damages baring out of the use or inability to use the hardware and software and/or any data loss, even if supplier has been informed about the possibility of such damages.

1.3 Recycling & disposal instructions.



Do not throw this product in the home waste bin.



1.4 Regulatory information.



For CE, FCC, RoHS and other Document of Conformities, consult the Contact Window of Darveen Computer.

1.5 Product Labeling

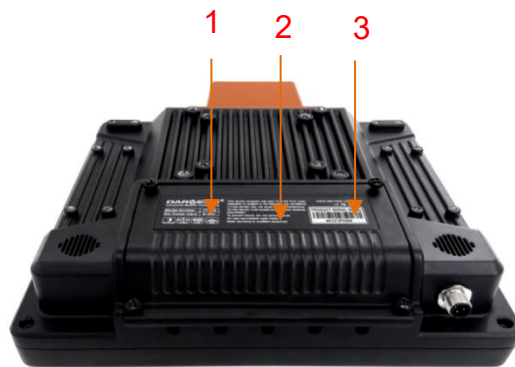

Figure 1-1 Product Labeling (Back side view)

Label nr.	Description
1	Product model name label
2	Serial number label
3	Microsoft Windows license label

Table 1- 1 Rear labeling

1.6 Product application scenaio

VT-708K assembly 10.1-inch industrial resistive touch screen which using high-temperature process.It is designed for Port and Container Yards, Manufacturing Logistics, Warehouse Management, Heavy Duty Vehicle and Fleet Management.

Chapter2. Description of Product

2.1 VT-708K

Congratulations on purchasing the VT-708K,VT-708K is a rugged vehicle mounted computer that comes with 10.1-inch touch screen, QWERTY keyboard and Intel Baytrial platform processor. Pre-installed Windows Embedded Standard or Professional operating system for applications in warehousing, fleet management and container terminal operating system, where it is mounted in industrial vehicles, such as forklifts, trucks, trailers, cranes and other heavy-duty vehicles. WiFi, LTE / 3.5G, Bluetooth and GPS modules can be integrated into the VT-708K for realtime data exchange, navigation and communications. The full-function QWERTY keyboard provide users friendly operations quickly and easily in the actual operation. These features as:

- 10.1" LED backlight panel with resistive touchscreen
- Integrated QWERTY Keyboard
- Rugged aluminum enclosure and fanless design
- Full IP65 dust/water protection
- Meet MIL-STD 810G standard anti-vibration shock
- Wide range 8-36V DC Power input with ignition control
- VESA 75 and 100 standard mounting
- Flexible expansion capability for WiFi, Bluetooth, LTE/HSPA+/EVDO, GPS,

CAN2.0B

2.2 General View of the VT-708K

2.2.1 Front view

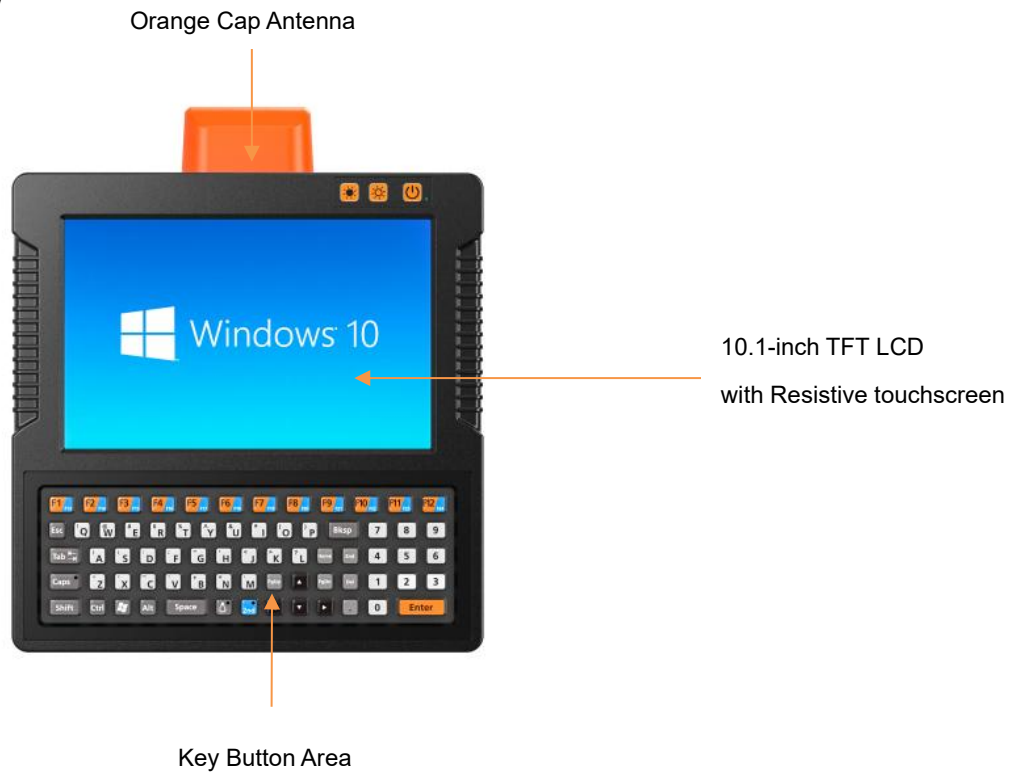

2.2.2 Back view

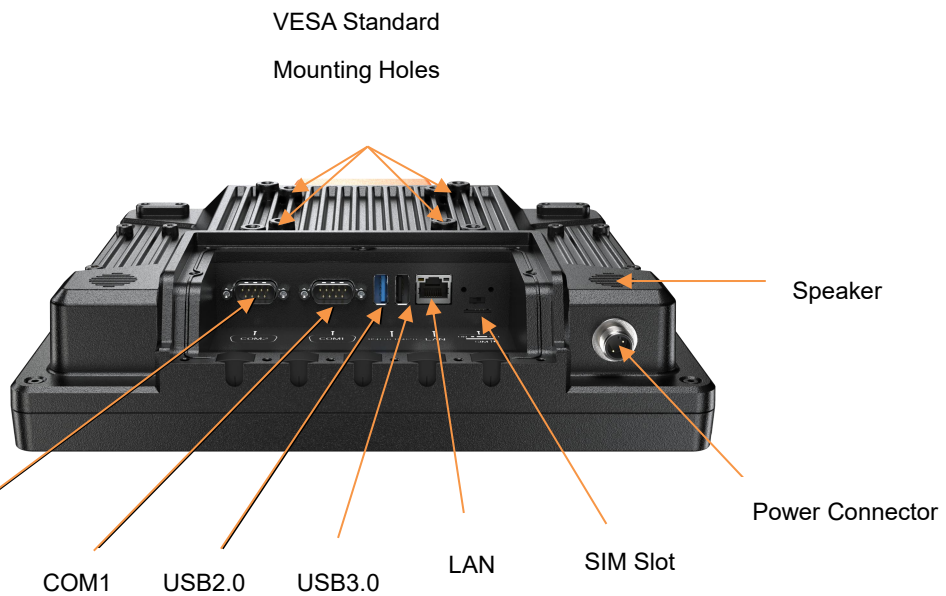

- * COM2 (Default)
- * 4DI/2DO (Optional)
- * 2xCAN2.0B (Optional)
- * Handset (Optional)

2.2.3 VT-708K Power Supply Connector

Power is supplied to the VT-708K through the power connector. Additionally this assembly provides a connection point for the vehicle's chassis ground to be connected internally to the conductive chassis of the computer.

The VT-708K internal power supply can accept DC input voltages in the range of 8 to 36V DC.

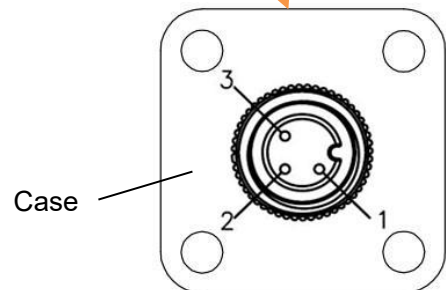

Pin	Signal	Description
1	V In+	DC Input+ (8-36 VDC)
2	Ignition	ACC Delay Ignition Switch
3	V In-	DC Input-
	Case	Chassis ground

2.3 System Specifications

The VT-708K detailed specifications as follows. Unless otherwise noted, all the specifications are subject to change without prior notification.

VT-708K	
Processor	- Intel® Quad-Core Celeron J1900(2.0GHz)
Memory	- 4GB SO-DIMM DDR3L-1333 (up to 8GB)
Storage	- 32GB mSATA SSD (Max. 512GB)
Operating System	- Windows - Ubuntu
Display	- 10.1" TFT LCD with LED backlight - 900cd/m ² Brightness - SVGA 1280 x 800 Resolution
Touch Panel	- 5-Wire Resistive Touch
Input / Output Ports	- 1 x RS-232/422/485 (COM1, full-function, Pin 9 function can be set to RI, 5V or 12V by jumper) - 1 x RS-232 (COM2, full-function, Pin9 function can be set to RI or 5V by jumper) - 1 x USB2.0 - 1 x USB3.0 - 1 x GbE LAN (RJ-45) - 4DI/2DO (Optional, with 3.3V power, substitute COM2) - 2 x CAN2.0B (Optional, compatible CAN2.0A, support J1939 protocol and in accordance with ISO 11898-1/2/3, substitute COM2) - 1 x SIM Card Slot (push and push) - 1 x Power Connector - 2/3/4 x TNC Connectors for External Antenna (WiFi, Bluetooth, WWAN, GPS) - 1 x Battery Switch
Audio	- 2 x 8Ω/2W
WLAN	- 802.11a/b/g/n (Optional, CCX v4 Certificated) - 802.11a/b/g/n/ac (Optional)
WWAN	- 4G (Optional, LTE, HSPA+, EDGE, GSM/GPRS, EVDO)

VT-708K	
Bluetooth	- Bluetooth 4.0 (Optional)
GPS	- SIRF III GPS/GLONASS (Optional) - Beidou GPS (Optional) - u-Blox GPS (Optional, 2.5 meters positioning accuracy)
Keypad	- Power On/Off - Brightness Adjustment - Power LED Indicator - Full 70-key QWERTY Keyboard - Integrated F1-F24 Function Keys, 0-9 Number and A-Z Alpha Keys - All Keys LED Backlight, Independent Switch Control Day and Night Mode
Power System	- Power Input: 8~36VDC - Power on delay, default 10 seconds; - Power off delay, default 10 seconds; (On/Off delay time can be changed via BIOS setting); - Hardware power off delay 70 seconds after ignition off; - Power Consumption: 18W typ. - 3350mAh/7.2V (Optional)
Dimensions and Weight	- Dimensions (L x W x H): 280 x 285 x 73 mm - Weight: 3.8Kg
Housing and Color	- Aluminum - Black

2.4 Environment Standard

Operating Temperature	-20~60°C
Mounting	VESA Mount, Vehicle Mount
Humidity	5%-95%, non-condensing
Shock	MIL-STD-810G Method 516.6 Procedure I
Vibration	MIL-STD-810G Method 514.6 Procedure I
Water & Dust proof	IP65 (I/O interface must be closed)

Chapter3. Function Using

3.1 Handling the VT-708K

3.1.1 Turn on the VT-708K

Press the Power button to turn on the VT-708K. If the VT-708K does not power on, check the power supply has been connected normally and you should try again.



Power Button

When the VT-708K is powered on, its operating system starts up. A splash screen of Darveen logo appears for a short period of time followed by the Windows 10 desktop window.

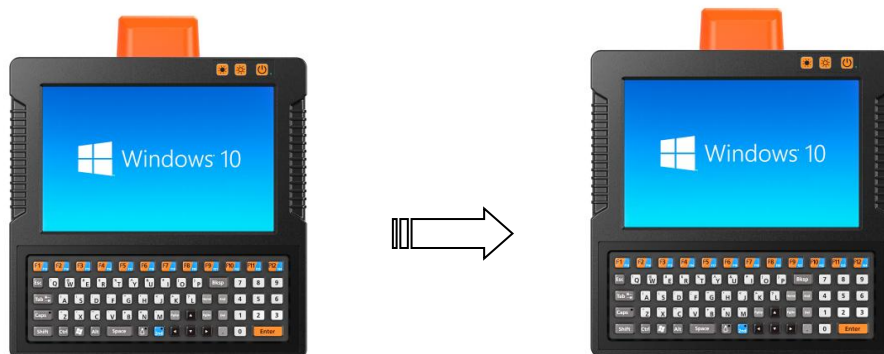

3.1.2 Adjust brightness

When the VT-708K is powered on and login Windows system, you can adjust screen brightness manually by pressing the button on the front of VT-708K.



Increasing brightness



Decreasing brightness



Label nr.	Description
1	LCD panel protection film
2	Keypad for power on/off, brightness control buttons
3	Full 70-key QWERTY Keyboard

3.2 Configure and calibrate the touch screen

PenMount touch screen is the most popular touch screen on the market. Penmount software support a wide range of configuration. You can use this software to configure and calibrate the touch screen. When the operating system is started, you can see the icon of **Penmount Monitor**  in the notification area.



1. Right-click on the **PenMount Monitor** icon  in the notification area and select **Control Panel** from the menu.

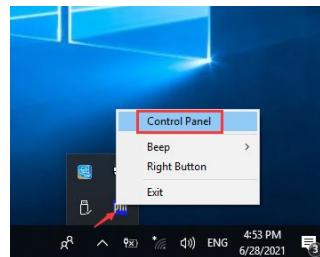

2. **PenMount Control Panel** opens. You will be able to see the icon of Penmount 6000 USB under **Device** tab. In the **Device** tab, you can see the devices detected on your system. Select a device and press the **Configure** button to configure it.

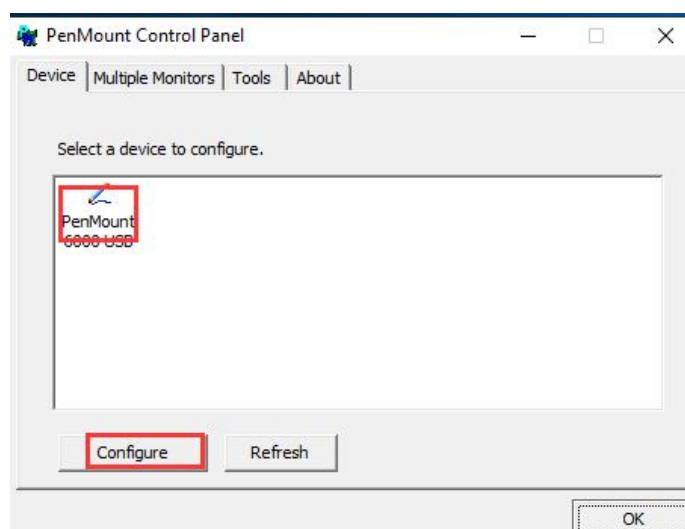

3. Click the “**Standard Calibration**” to start standard calibration.

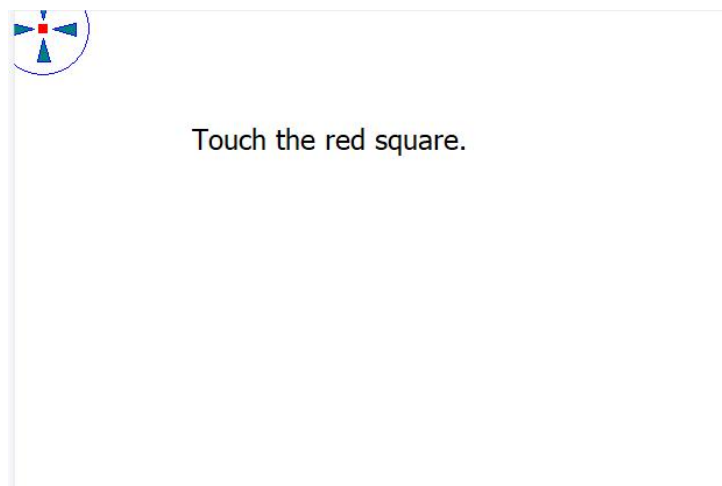
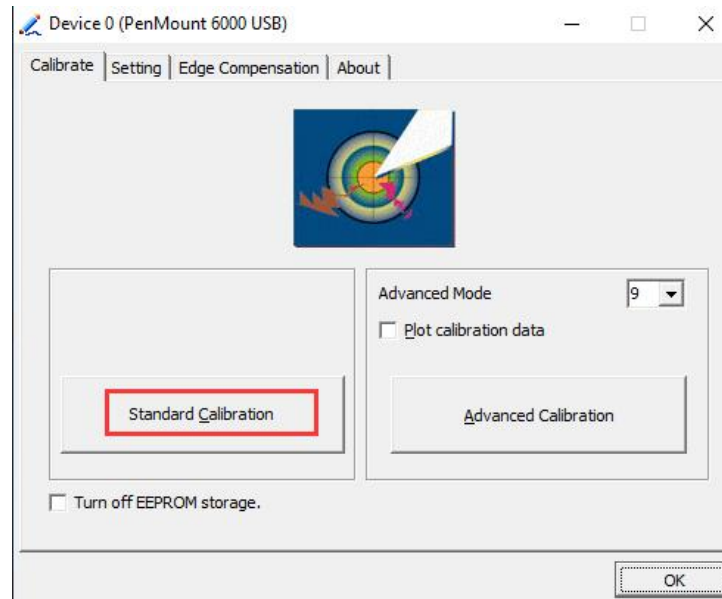

NOTE: *The older the touchscreen gets, the more **Advanced Mode** calibration points you need for an accurate calibration. Use a stylus for **Advanced Calibration** for greater accuracy. Do the following for **Advanced Calibration**:*

4. Back in Calibrate tab, press “**Advanced Calibration**” button to start Advanced Calibration.

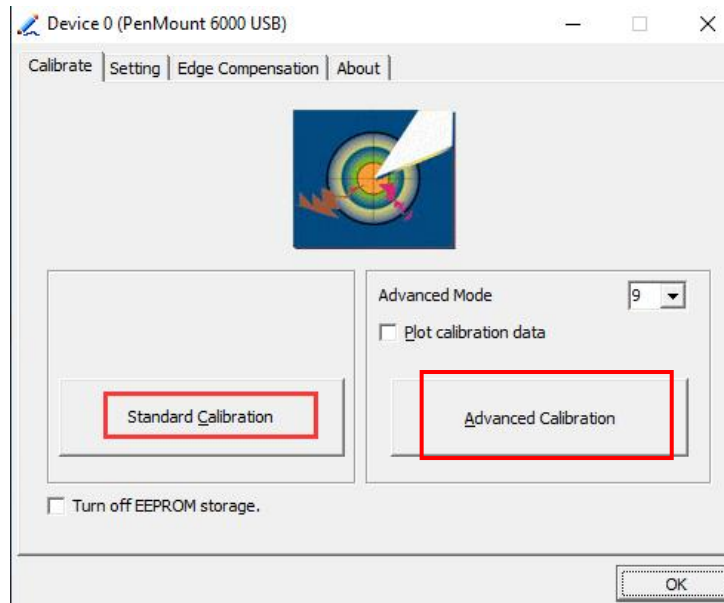

Touch the red square.

<p>Plot Calibration Data <input type="checkbox"/> Plot calibration data</p>	<p>Check this function to have touch panel linearity comparison graph appear when you finish Advanced Calibration. The black lines reflect the ideal linearity assumed by PenMount’s application program while the blue lines show the approximate linearity calculated by PenMount’s application program as the result of user’s execution of Advance Calibration.</p>
<p>Turn off EEPROM storage <input type="checkbox"/> Turn off EEPROM storage.</p>	<p>This function disables the write-in of calibration data in Controller. This function is enabled by default.</p>

5. **Setting** tab, you can do some configuration for the touch screen.

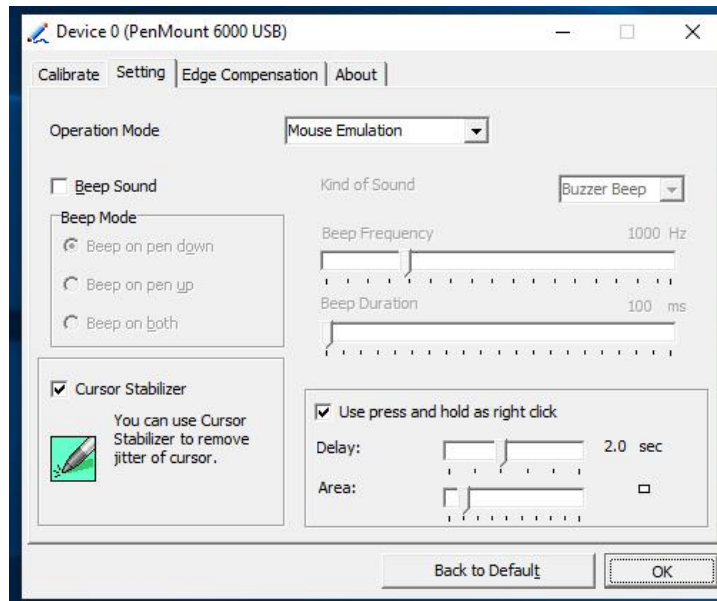

➤ **Operation Mode**

This mode enables and disables mouse’s ability of dragging on-screen icons—useful for configuring POS terminals.

Pen Input Emulation	Select this mode and mouse will emulate Windows Vista pen input device operation, by which no mouse event will be sent until the touch is dragged out of range or released from the screen.
Mouse Emulation	Select this mode and mouse functions as normal and allows dragging of icons.
Click on Touch	Select this mode and mouse only provides a click function, and dragging is disabled.
Click on Release	Select this mode and mouse only provides a click function when the touch is released.

➤ **Beep Sound**

Enable Beep Sound	turns beep function on and off.
Beep on Pen Down	beep occurs when pen comes down.
Beep on Pen Up	beep occurs when pen is lifted up.
Beep on both	beep occurs when comes down and is lifted up.
Beep Frequency	modifies sound frequency.
Beep Duration	modifies sound duration.

➤ **Cursor Stabilizer**

Enable the function support to prevent cursor shake.

➤ **Use press and hold as right click**

You can set the time out and area for you need

6. **Edge Compensation** tab, you can adjust the settings from 0 to 30 for accommodating the difference of each touch panel.

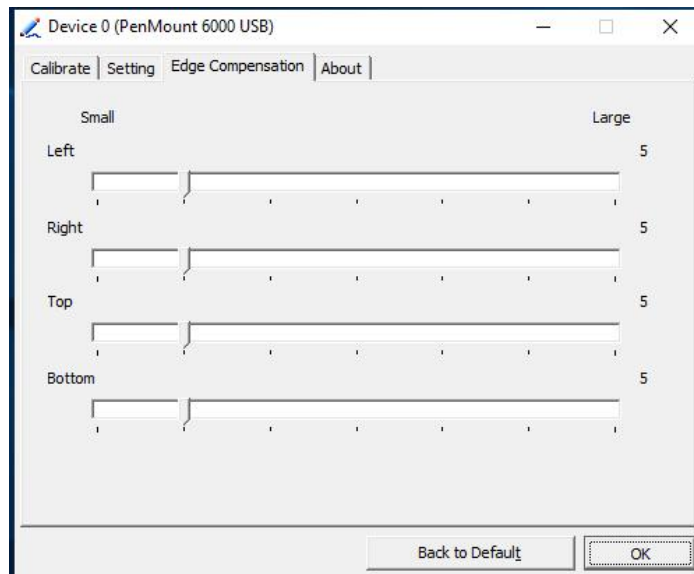

7. **About** tab, This panel displays information about the PenMount controller and driver version

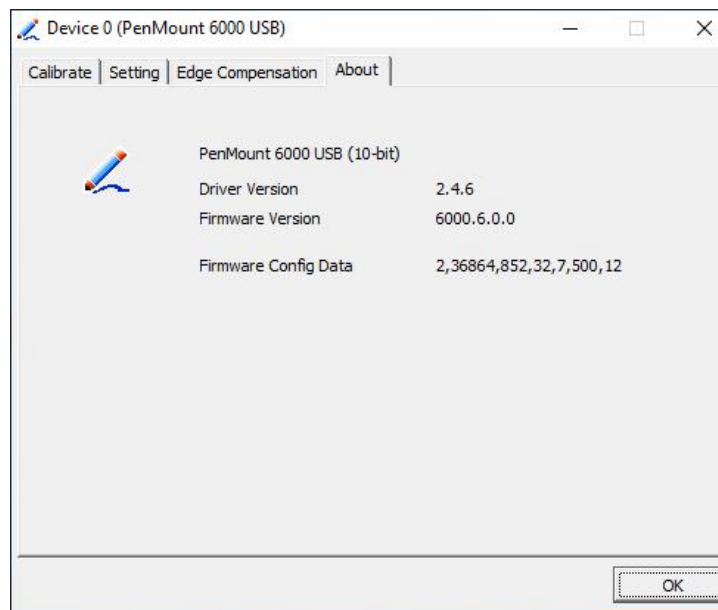

3.3 Wireless LAN

3.3.1 Intel 7260

1. Verify that the driver for the Intel 7260 wireless module has been installed by looking in **Device Manager** or **Programs and Function**.

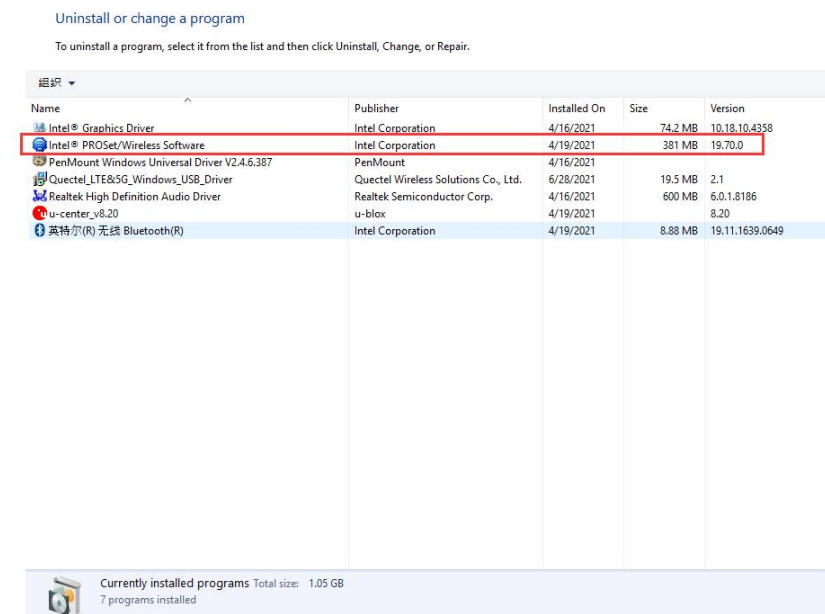
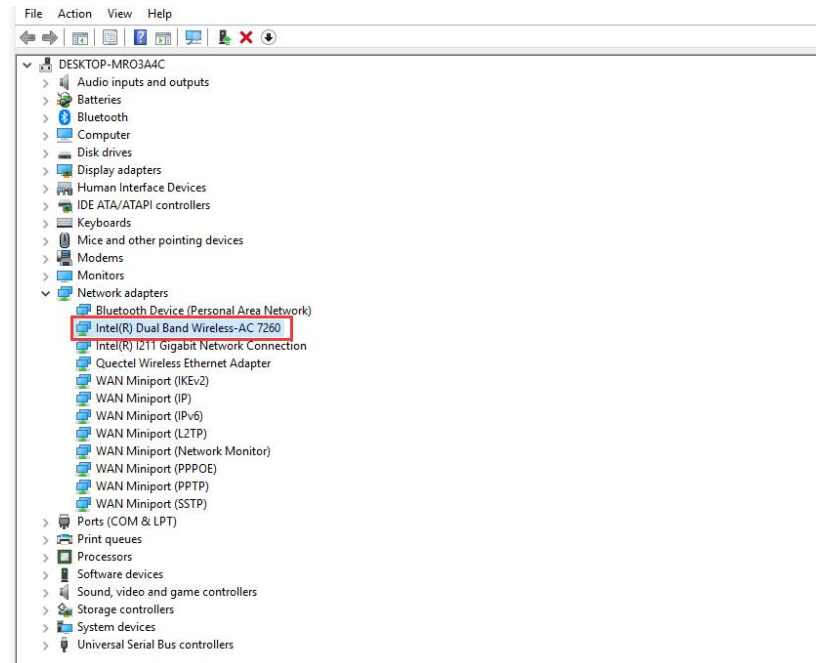

2. Click on the wireless signal icon in the lower right corner of the desktop to view the list of wireless signals, select the WiFi signal you want to connect to, and enter the correct password.

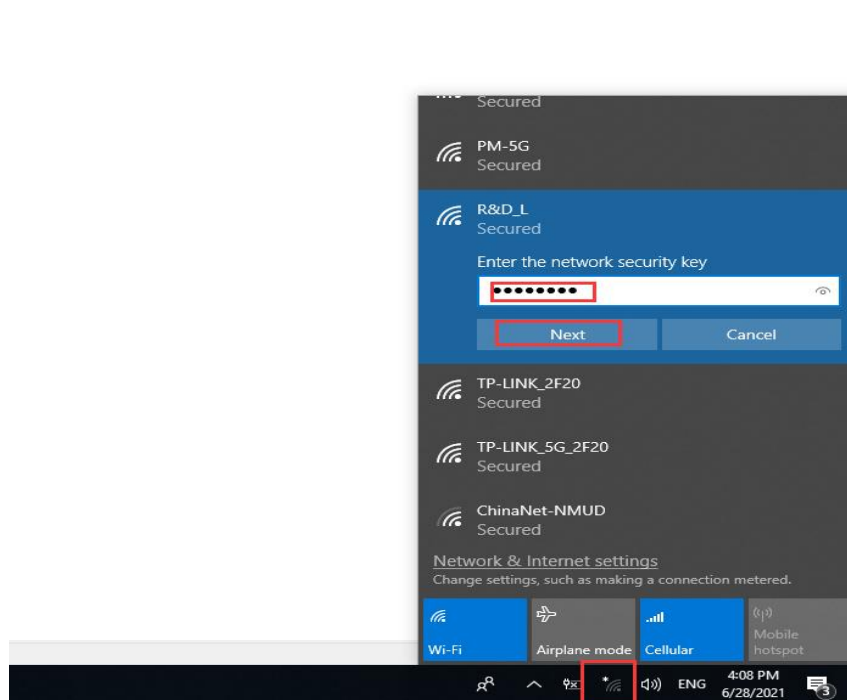

3. At this point, the wireless network is properly connected, and you can use the wireless network to surf the Internet.

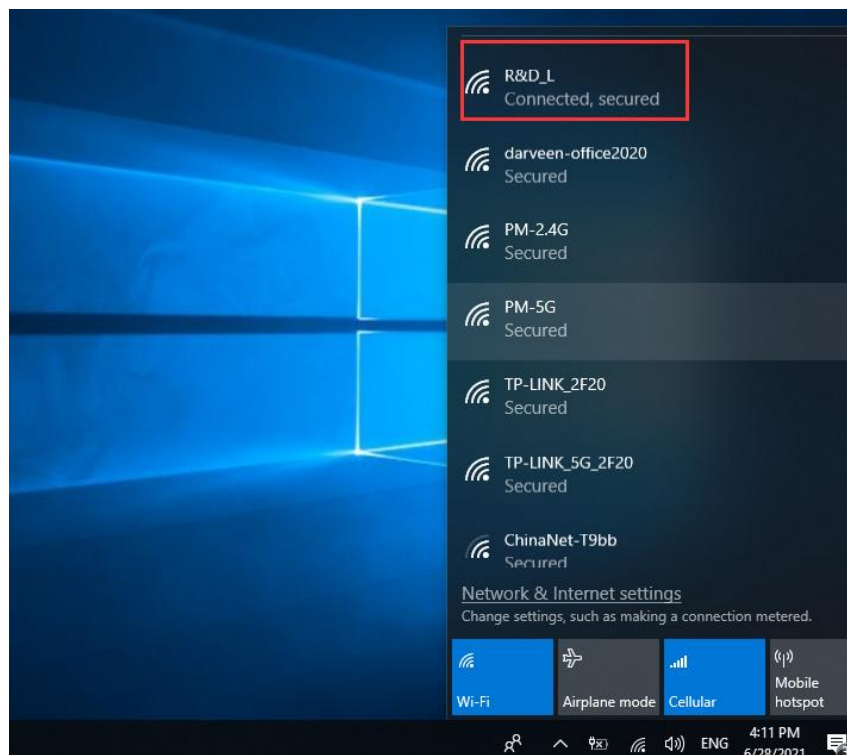

3.3.2 Summit (Win10)

1. Verify that the driver for the Summit PE15N wireless module has been installed by looking in **Device Manager** or **Programs and Function**.

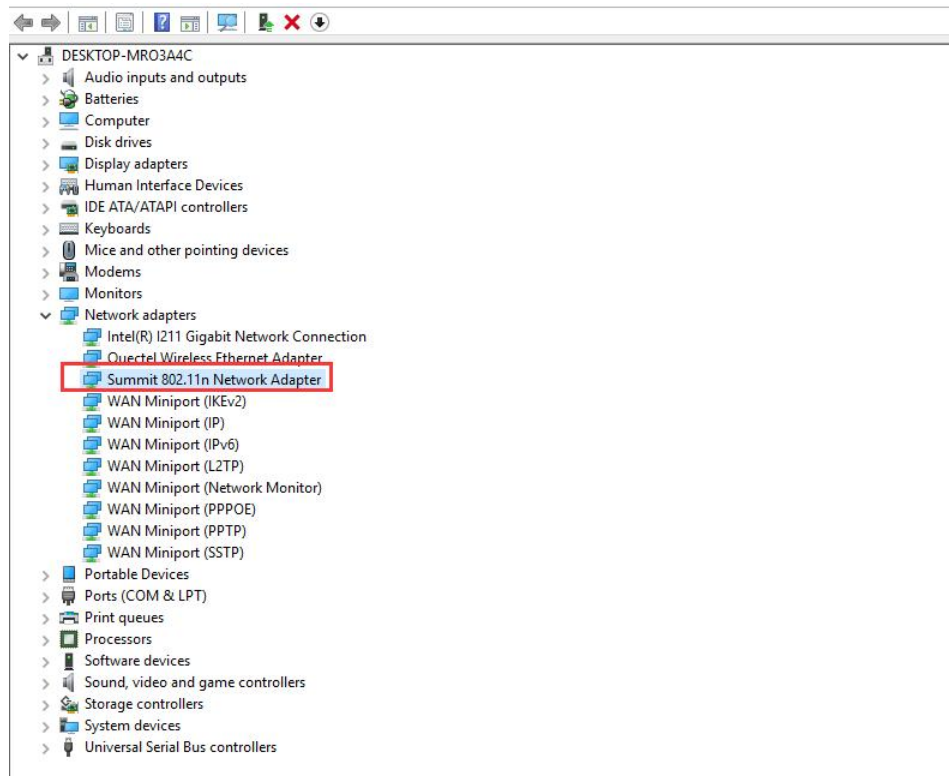

Uninstall or change a program

To uninstall a program, select it from the list and then click Uninstall, Change, or Repair.

Name	Publisher	Installed On	Size	Version
Intel® Graphics Driver	Intel Corporation	4/16/2021	74.2 MB	10.18.10.4358
Laird_PE15N_NDIS6	Laird	6/28/2021	11.0 MB	3.04.18.000
PenMount Windows Universal Driver V2.4.6.387	PenMount	4/16/2021		
Quetel_LTE&5G_Windows_USB_Driver	Quetel Wireless Solutions Co., Ltd.	6/28/2021	19.5 MB	2.1
Realtek High Definition Audio Driver	Realtek Semiconductor Corp.	4/16/2021	600 MB	6.0.1.8186
u-center_v8.20	u-blox	4/19/2021		8.20
英特尔(R) 无线 Bluetooth(R)	Intel Corporation	4/19/2021	8.88 MB	19.11.1639.0649

2. Click on the wireless signal icon in the lower right corner of the desktop to view the list of wireless signals, select the WiFi signal you want to connect to, and enter the correct password.

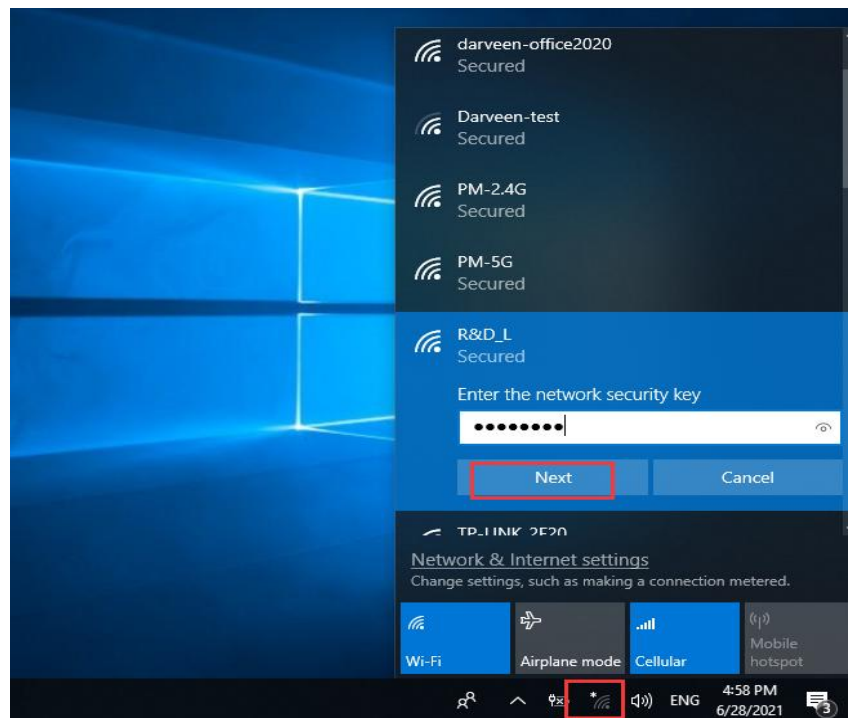

3. At this point, the wireless network is properly connected, and you can use the wireless network to surf the Internet.

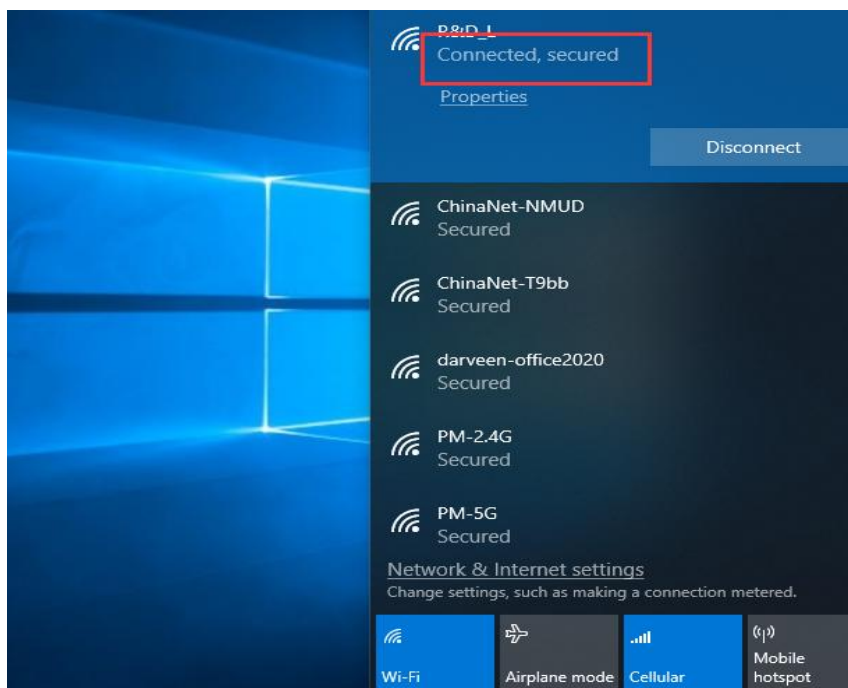

3.3.3 Summit (Win7)

(1) About SCU

The Summit Client Utility (SCU) is an application designed for end users and administrators of mobile devices that use a Summit radio module. Using SCU, an end user can:

- Disable the radio (turn it off) and enable the radio (turn it on)
- View the contents of configuration profiles, or profiles, each of which houses the RF, security, and other settings for the radio
- Select the profile to be used to connect to a WLAN
- View global settings, which apply to every profile
- View status information on the radio, the access point (AP) or WLAN router to which it is connected, and the RF connection or link between the two devices
- To troubleshoot a connection or performance issue, view in-depth diagnostic information on the connection and the radio, and perform various troubleshooting and diagnostic tests

After completing an administrator login to the utility, a user can perform these additional tasks:

- Create, rename, edit, and delete profiles
- Alter global settings, which apply to every profile

SCU provides a graphical user interface (GUI) for access to all of its functions. Access to these functions also is available through an application programming interface (API), which an application programmer can use to enable another utility to manage the radio.

To initialize SCU:

- From the Start menu, select Programs
- Select the directory called Summit
- Inside the Summit directory are two items: a directory for the storage of security certificates and an SCU icon. To run SCU, double-click the SCU icon

SCU has five tabs: Main, Profile, Status, and Diags, and Global. Each tab is described in more detail in this section.

1. Main Tab



- **Admin Login/Logout:** Click the Admin Login button. An input field appears for the password, the standard password is: **SUMMIT** (must be entered in capital letters!) , You can find details about the configuration parameters in the SCU online help at:
http://www.summitdatacom.com/Documents/summit_users_guide_3_03.html
- **Enable/Disable Radio:** When the radio is enabled, selecting this button disables it; when the radio is disabled, selecting this button enables it.
- **Active Profile:** You can view the name of the active profile and, using the selection list, select a different profile.
If you select “ThirdPartyConfig” then, after the device goes through a power cycle, WZC is used for configuration of the radio.
- **Status:** Indicates the radio’s status.
- **Radio Type:** Indicates the type of radio in the device.
“BG” means a Summit radio that supports 802.11b and 802.11g.
- **Regulatory Domain:** Indicates the regulatory domain or domains for which the radio is configured.
“Worldwide” means that the radio can be used in any domain.
The domain cannot be configured by an administrator or user.

- **Driver:** Indicates the version of the device driver that is running on the device.
- **SCU:** Indicates the version of SCU that is running on the device.
- **About SCU:** When tapped, supplies information on SCU that on a Windows application normally would appear under Help\About.

2. Profile Tab

Profile settings are radio and security settings that are stored in the registry as part of a configuration profile. When a profile is selected as the active profile on the Main tab, the settings for that profile become active. An administrator can define up to 20 profiles, edit them, and delete them on the Profile tab in SCU. **Profile changes made on the tab are saved to the profile only when the Commit button is pressed.**

Unless it is modified, the Default profile does not specify an SSID, EAP type, or method of encryption. If the Default profile is the active profile, then the radio will associate only to an access point that broadcasts its SSID and requires no EAP type and no encryption.

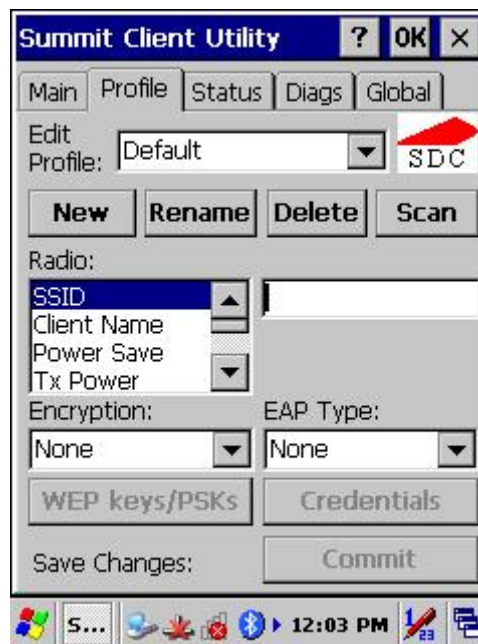

- **Edit Profile:** This is used to select the profile to be viewed or, if you are an administrator, edited.
- **Actions:** Four actions are available, with the first three available only to an administrator:
 - **New:** Create a new profile with default settings and give it a unique name (and then change settings using other selections on the tab).
 - **Rename:** Give the profile a new name, one that is not assigned to another profile

- **Delete:** Delete the profile, provided that it is not the active profile.
- **Scan:** Open a window that lists access points that are broadcasting their SSIDs. Each time you tap the Refresh button, you view an updated list of APs, with each row showing an AP's SSID, its received signal strength indication (RSSI), and whether or not data encryption is in use (true or false). You can sort the list by clicking on the column headers. If you are authorized as an administrator, select an SSID in the list, and tap Commit, you return to the Profile tab to create a profile for that SSID.
- **Radio:** Radio attributes in the list box can be selected individually. When an attribute is selected, the current setting or an appropriate selection box with the current setting highlighted appears on the right.
- **Security:** Values for the two primary security attributes, EAP type and encryption type, are displayed in separate dropdown lists, with the current values highlighted. When you as an administrator select an EAP type, the Credentials button appears; when you tap it, a dialog box appears that enables you to define authentication credentials for that EAP type. When you as an administrator select an encryption type that requires the definition of WEP keys or a pre-shared key, the PSKs/WEP Keys button appears; when you tap it, a dialog box appears that enables you to define WEP keys or a PSK.
- **Commit:** To ensure that changes to profile settings made on the tab are saved in the profile, you must tap the Commit button.

To cause a Summit radio to connect to a typical business WLAN, you must select a profile that specifies the SSID, EAP type, and encryption type supported by the WLAN:

- **SSID:** This is the name or identification of the WLAN.
- **EAP type:** This is the protocol used to authenticate the device and its user if the WLAN uses the Enterprise version of Wi-Fi Protected Access (WPA) and WPA2. SCU supports five EAP types: PEAP with EAP-MSCHAP (PEAP-MSCHAP), PEAP with EAP-GTC (PEAP-GTC), EAP-TLS, LEAP, and EAP-FAST
- **Encryption:** This specifies the type of key used to encrypt and decrypt transmitted data and how that key is specified or derived. Encryption options include:
 - WPA2 or WPA with dynamic keys (derived from the EAP authentication process)
 - WPA2 or WPA with pre-shared keys
 - Static WEP keys

Consult the user's guide for details on all profile settings, including security settings.

3. Status Tab

The Status tab provides status information on the radio.

- Active profile
- Radio's status: Down (not recognized), Disabled, Not Associated, Associated, or [EAP type] Authenticated
- Client info: Name, IP address, and MAC address
- AP info: Name, IP address, MAC address, beacon period, and DTIM interval
- Connection info: Channel, data rate, transmit power, signal strength, and signal quality



4. Diags Tab



- **(Re)connect:** Disable and enable the radio, apply or reapply the current profile, and attempt to associate and authenticate to the wireless LAN, logging all activity in the output area at the bottom.
- **Release/Renew:** Obtain a new IP address through DHCP release/renew, and log all activity in the output area at the bottom.
- **Start Ping:** Start a continuous ping to the address in the edit box next to it. Once the button is clicked, its name and function will change to Stop Ping. Moving to an SCU window other than Status or Diags also will stop the ping, as will Pings will continue until you tap the Stop Ping button, move to an SCU window other than Diags or Status, exit SCU, or remove the radio.
- **Diagnostics:** Attempt to (re)connect to an AP, and provide a more thorough dump of data than is obtained with (Re)connect. The dump will include radio state, profile settings, global settings, and a BSSID list of APs in the area.
- **Save To...:** Save the diagnostics output to a file.

5. Global Tab

Global settings include:

- Radio and security settings that apply to all profiles
- Settings that apply to SCU itself

An administrator can define and change most global settings on the Global Settings Tab in SCU.

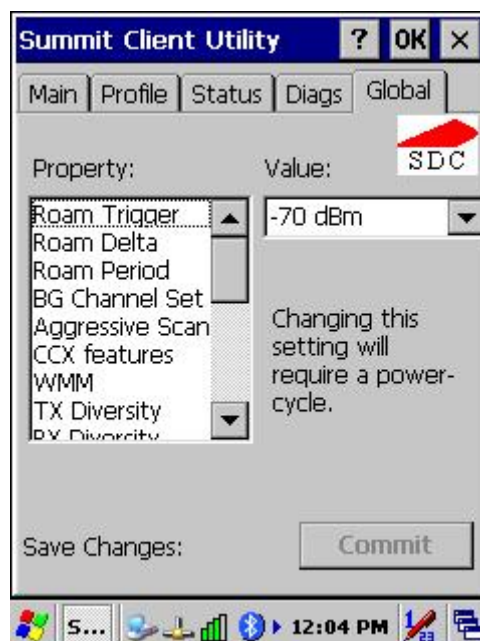

The default setting for each global setting ensures reliable operation in most environments. Consult the user's guide for details on all global settings.

(2) How to use Summit Client Utility (SCU)

The Summit client device is a Summit 802.11a/b/g/n radio, capable of 802.11a, 802.11b, 802.11g and 802.11n data rates. The radio can be configured for no encryption, WEP encryption or WPA security.

For best results, do not use the Network Connections panel (**Start > Control Panel > Network Connections**) to disable the Summit wireless adapter. Due to a limitation of the system architecture, if the Summit wireless adapter is disabled in the Network Connections panel, it cannot be re-enabled from this control panel. Instead, the VT-708K must be rebooted to enable the Summit wireless adapter.

The Device Manager (**Control Panel > System > Hardware > Device Manager**) can be used to disable and enable the Summit wireless adapter without rebooting the VT-708K.

Note:

- 1. When making changes to profile or global parameters, the device should be restarted afterwards.*
- 2. The Summit tray icon is not shown when the VT-708K is running Windows Embedded 7 or Windows 7 Professional. The Windows Wireless icon (located in the taskbar) may not display a successful wireless connection. The SCU Main tab should be used to verify the success of the connection instead.*

Start > All Programs > Summit > Summit Client Utility or

SCU Icon on Desktop or

Summit Tray Icon (if present) or

Wi-Fi Icon in the Windows Control Panel (if present)

The **Main** tab provides information, admin login and active profile selection.

Profile specific parameters are found on the **Profile** tab. The parameters on this tab can be set to unique values for each profile.

The **Status** tab contains information on the current connection.

The **Diags** tab provides utilities to troubleshoot the radio.

Global parameters are found on the **Global** tab. The values for these parameters apply to all profiles.

Using the SCU to connect the APs, you can refer to the following steps:

1. Double click **“SCU”** icon on the Windows desktop to run Summit Client Utility;



2. Click **“Admin Login”** button on the **Main** tab, Enter admin password **“SUMMIT”**, then click **“OK”** to login.

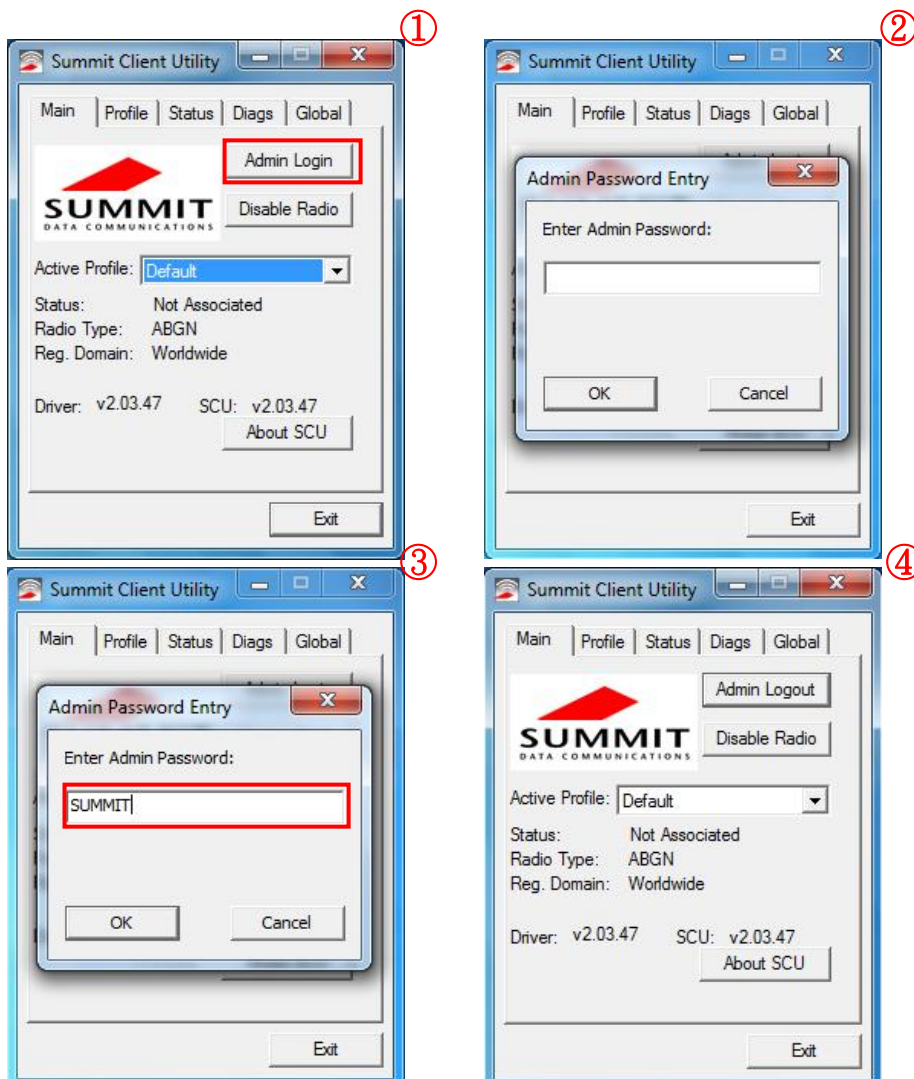

3. Click **“Scan”** button on the **Profile** tab, there is another window that will show some APs name after many seconds, and it will refresh every few seconds.

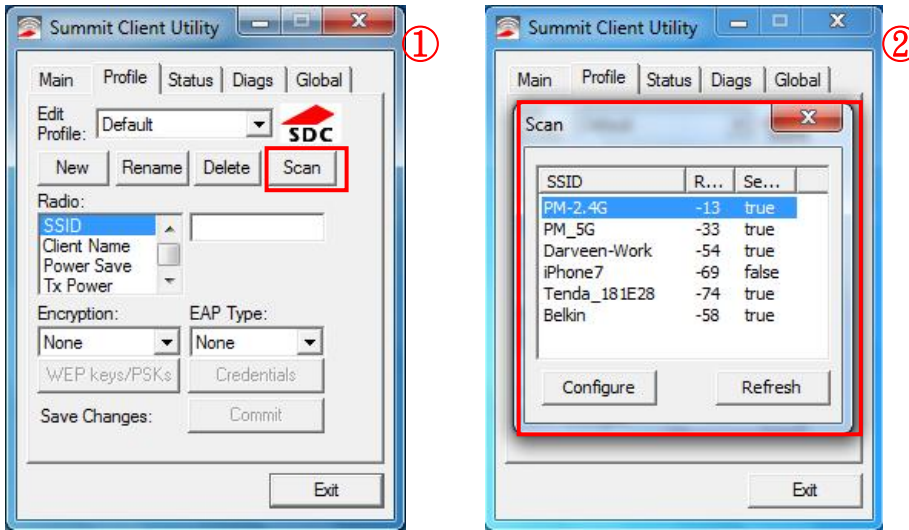

4. Select the AP's SSID you want to connect, like **“PM-2.4G”**, click **“Configure”** button, then click **“Yes”**, enter the correct password and click **“OK”** to confirm.

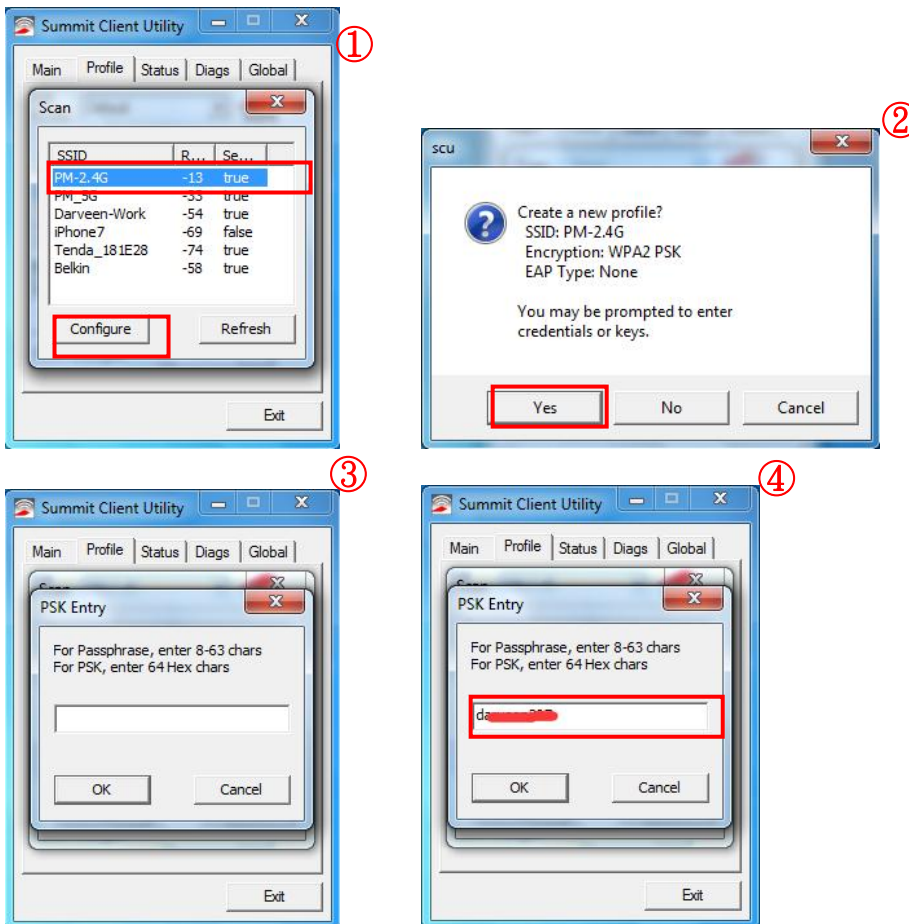

- On the **Profile** tab, set the “**Power Save**” mode to “**CAM**” (Constantly Awake Mode), click “**Commit**” button to confirm.

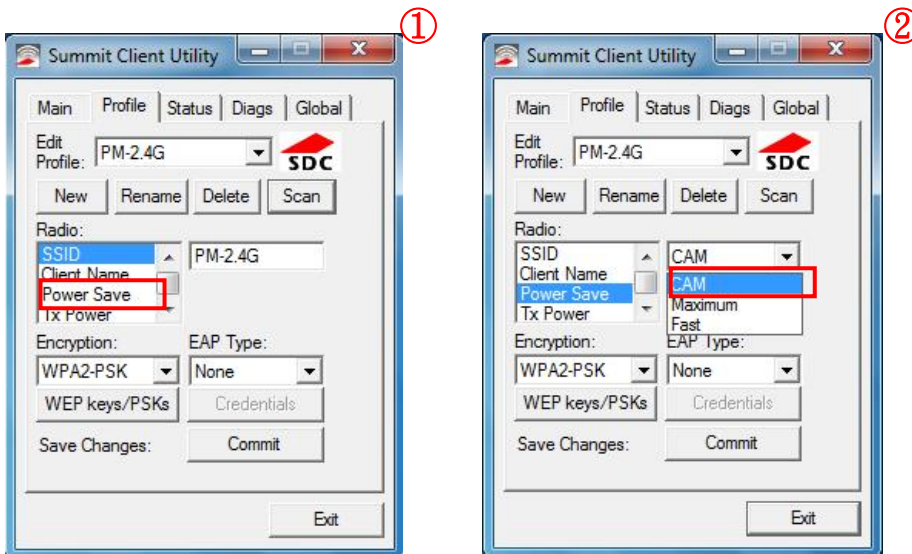

- Go back to **Main** tab, select the AP’s SSID you configured in the drop-down menu of “**Active Profile**”, such as “PM-2.4G”, then you can see the connection status and radio type.

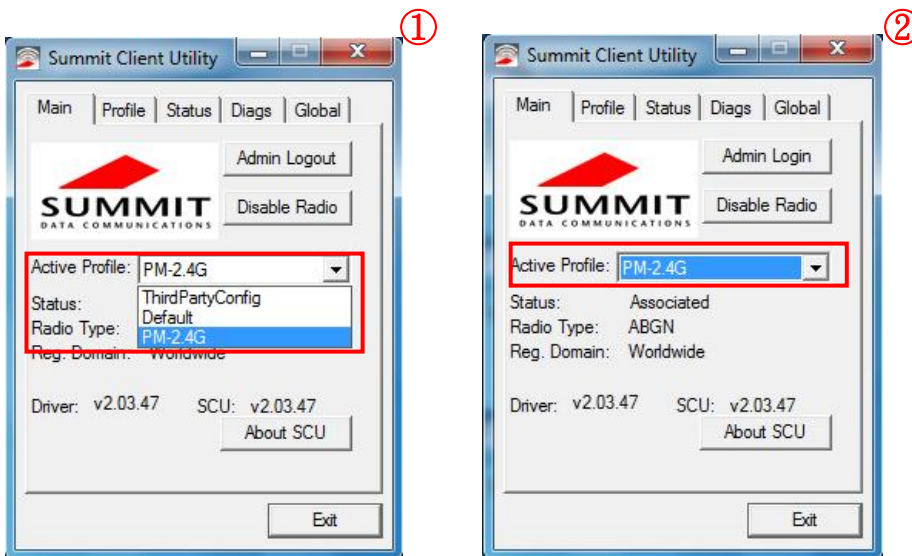

7. You can see more detail status of connection on the **Status** tab, it will be shown some connection information, such as active profile, status, IP address, signal strength and so on.

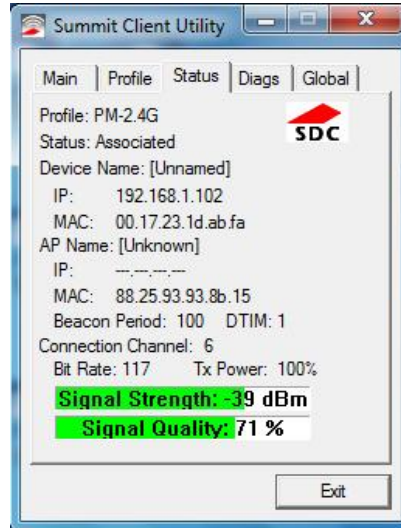

8. You can also set roaming performance parameters were optimized on the **Global** tab.

Roam Trigger:	-75 dBm
Roam Delta:	5 dBm
Roam Period:	5 sec

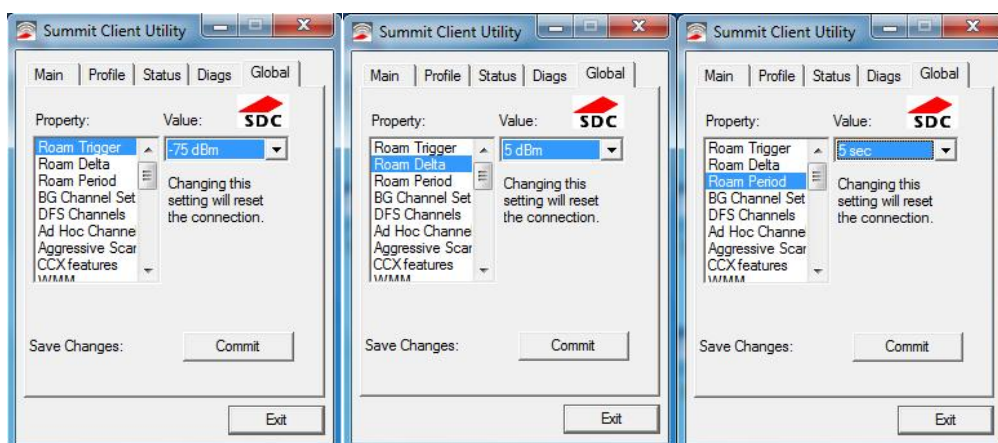

(3) How to use Wireless Zero Config (WZC) Utility



- The WZC utility has an icon in the toolbar indicating the Wireless Zero Config application is enabled but the connection is inactive at this time (the device is not connected to a network). The WZC icon may not be visible until control is passed to the WZC utility as described below.
- You can use either the Wireless Zero Configuration Utility or the Summit Client Utility to connect to your network. The Summit Client Utility is recommended because the Wireless Zero Configuration Utility cannot control the complete set of security features of the radio.

1. To Switch Control to the Wireless Zero Config Utility

- (1) Select **ThirdPartyConfig** in the Active Profile drop down box on the **Main** tab.

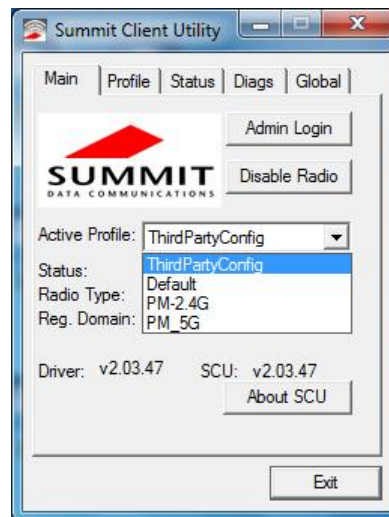

- (2) A message appears that a Power Cycle is required to make settings activate properly.

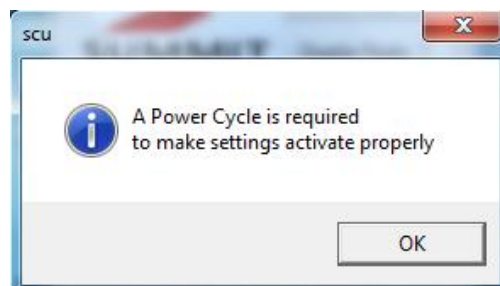

- (3) Tap **OK**.
- (4) Restart the VT-708K.

The Summit Client Utility passes control to Wireless Zero Config and the WZC Wireless Information control panel. Using the options in the Wireless Zero Config panels, set up radio and security settings. There may be a slight delay before the Wireless Zero Config icon indicates the status of the connection.

2. To Switch Control to SCU

- (1) To switch back to SCU control, select any other profile except **ThirdPartyConfig** in the SCU Active Config drop down list on the **Main** tab.
- (2) A message appears that a Power Cycle is required to make settings activate properly.
- (3) Tap **OK**.
- (4) Restart the VT-708K.

Radio control is passed to the SCU.

Using the Wireless Zero Config (WZC) utility to connect the APs, you can refer to the following steps:

1. Tap the WZC utility icon in the toolbar, as below picture.

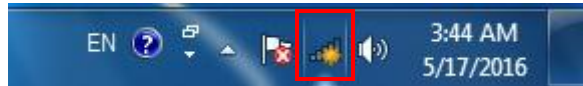

2. Select the AP's SSID you want to connect, such as "PM-2.4G",



3. Click “Connect” button, then enter the correct password to confirm.



4. Take some time to verify the connection.

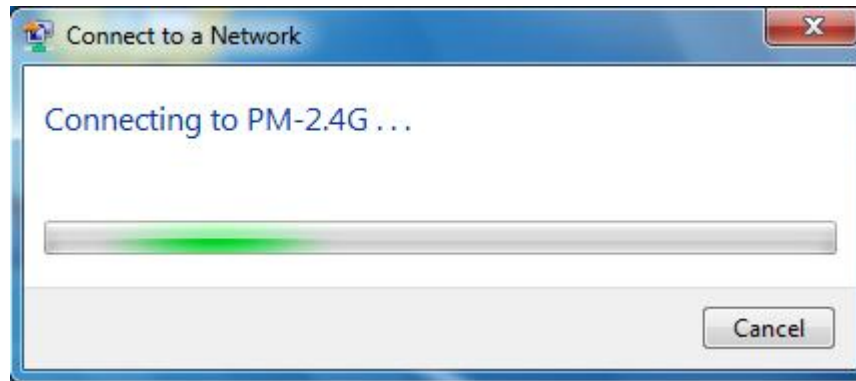

5. Once verified, the AP will be connected successfully, shown as below picture.



3.4 Bluetooth (Win10)

3.4.1 Turun on the Bluetooth

1. Click the Start button in the lower-left corner of your screen and Type bluetooth settings in the search box, then select **Bluetooth and other devices** from the results.

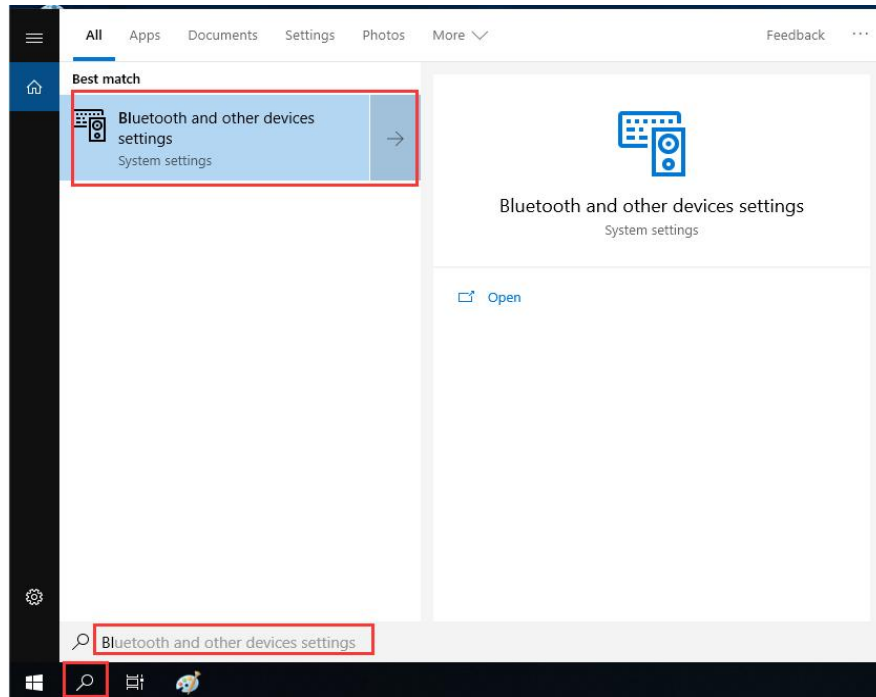

2. Turn on your Bluetooth device and make it discoverable.

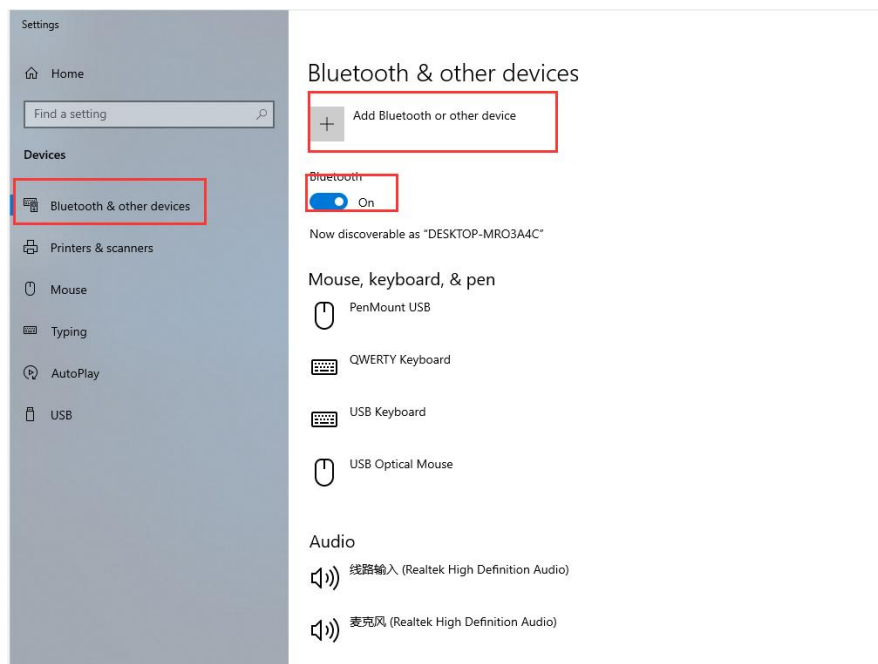

3.4.2 Connect to the Bluetooth

1. Add the Bluetooth device you want to connect to.

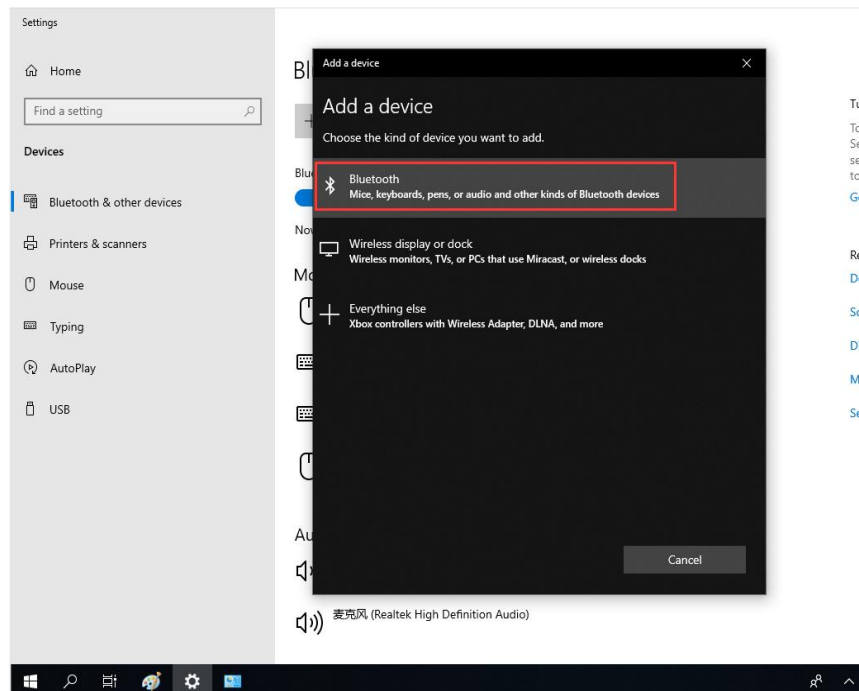

2. For many devices, you'll see a passcode. Ensure the key on VT-708K and the device are the same. This helps you ensure you're connecting the device to the correct machine, and not another nearby computer. You'll need to confirm the code on both VT-708K and other machine.

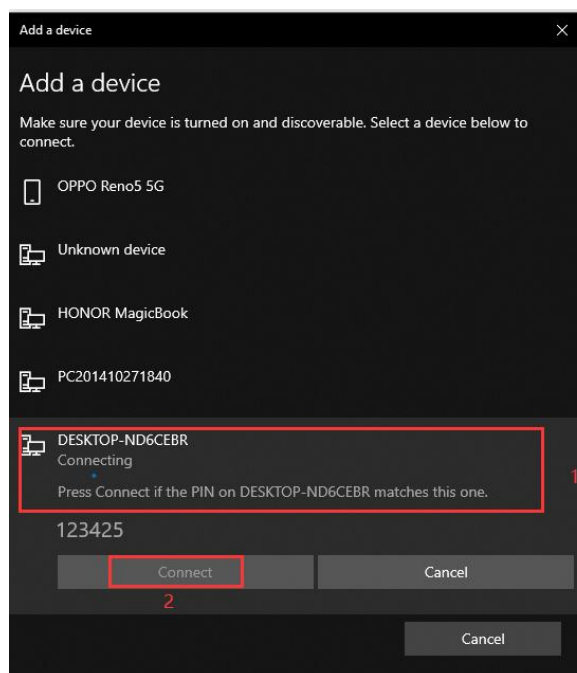

Turn on Bluetooth even fas
To turn on Bluetooth witho
Settings, open action cent
select the Bluetooth icon. I
to turn it off when you war
[Get more info about Bluet](#)

Related settings
[Devices and printers](#)
[Sound settings](#)
[Display settings](#)
[More Bluetooth options](#)
[Send or receive files via Blit](#)

3. Before sending a file to another device, select the following options on the receiving device and wait for the file to be received.

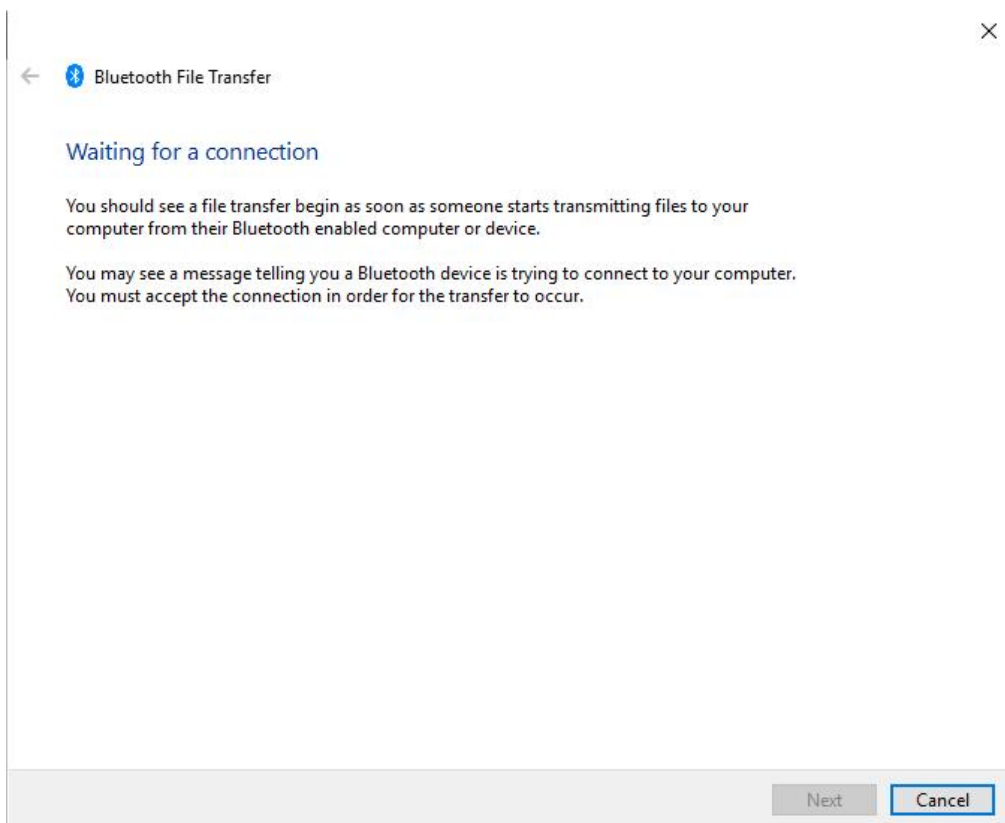
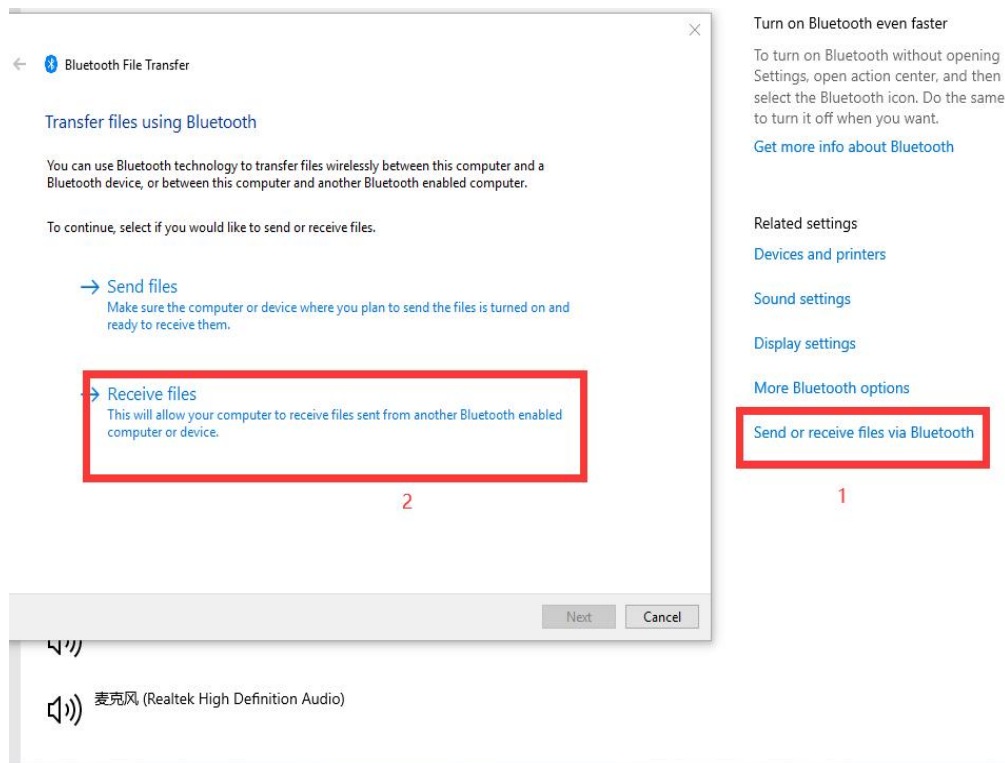

4. Send files via Bluetooth to other devices by VT-708K.

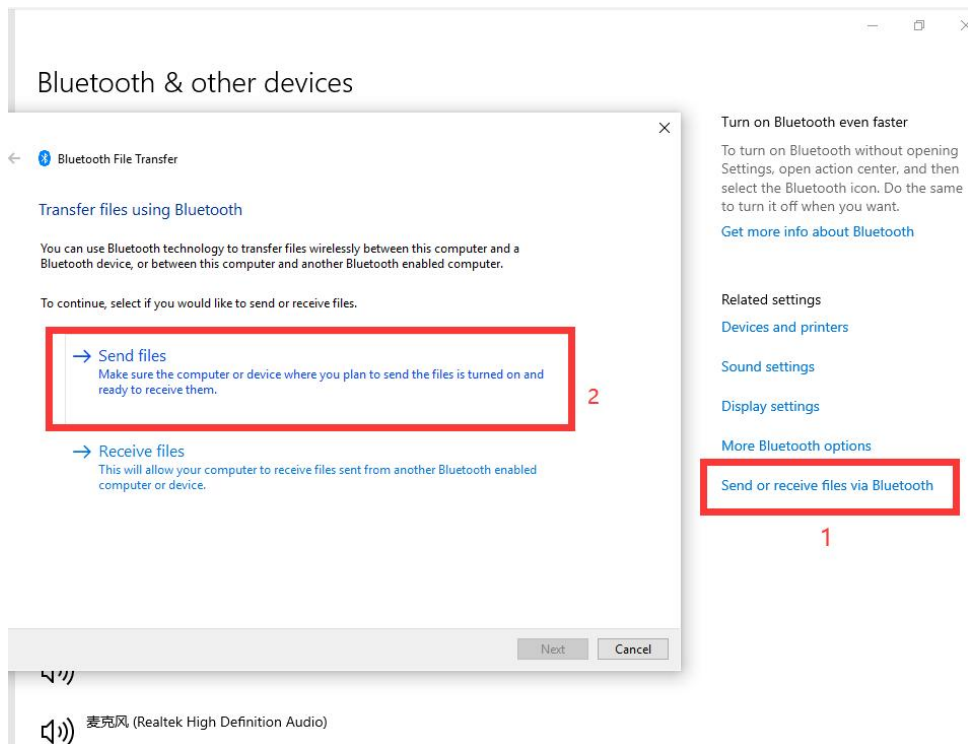

5. Select the device you want to send.

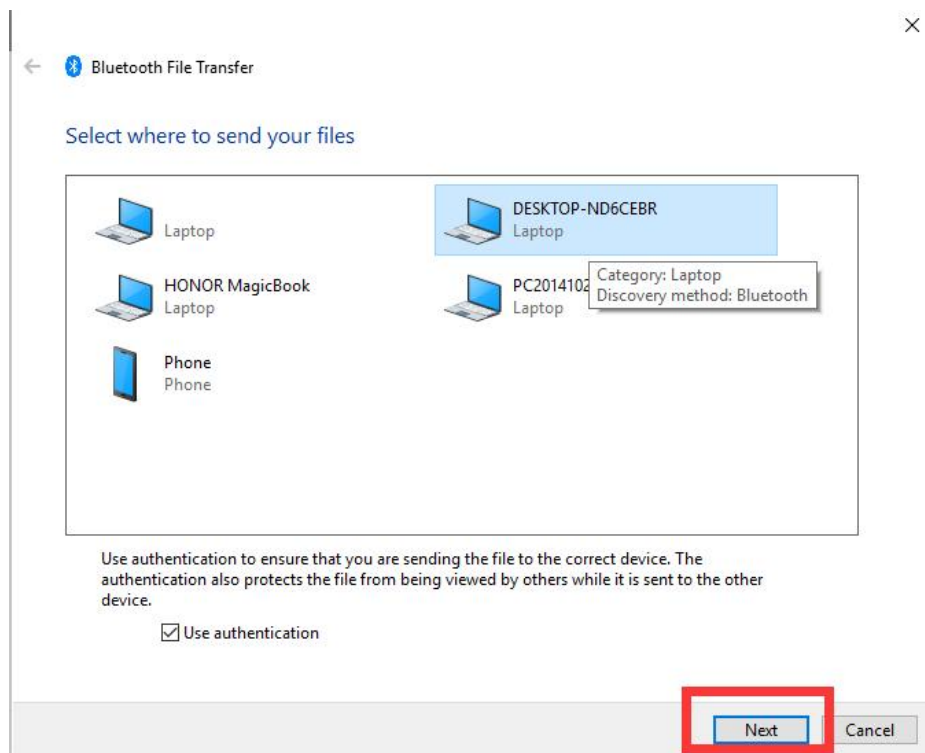

6. Select the file you want to send. And wait for the file to be sent completely.

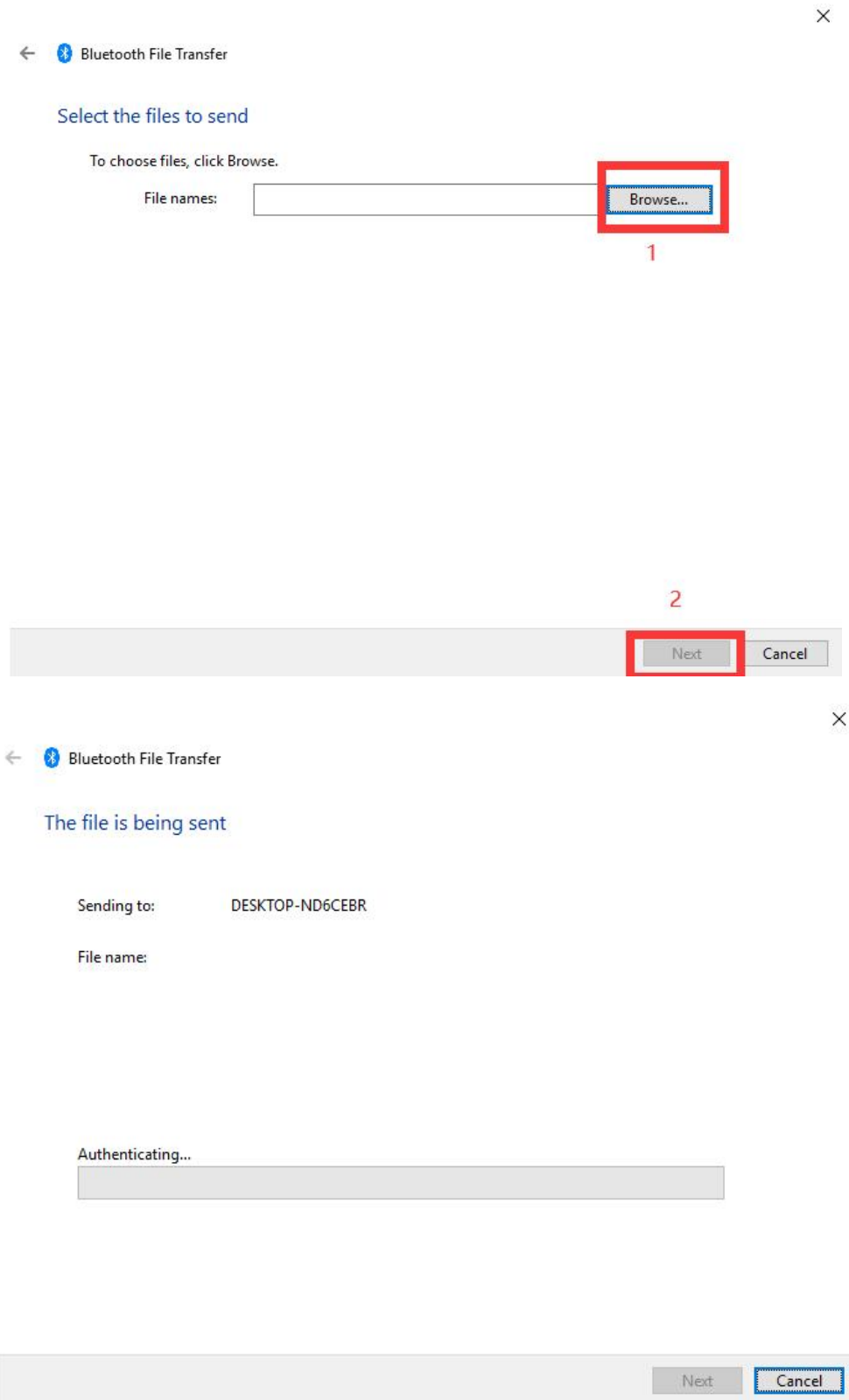

In this way, through the Bluetooth function to complete the file transfer between devices.

7. To make it easier to set the Bluetooth device next time you turn it on, you can set it as follows.

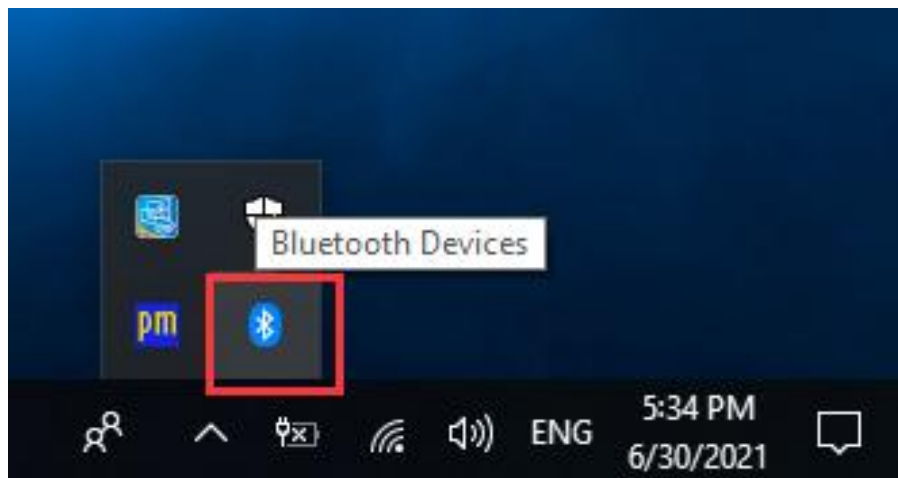
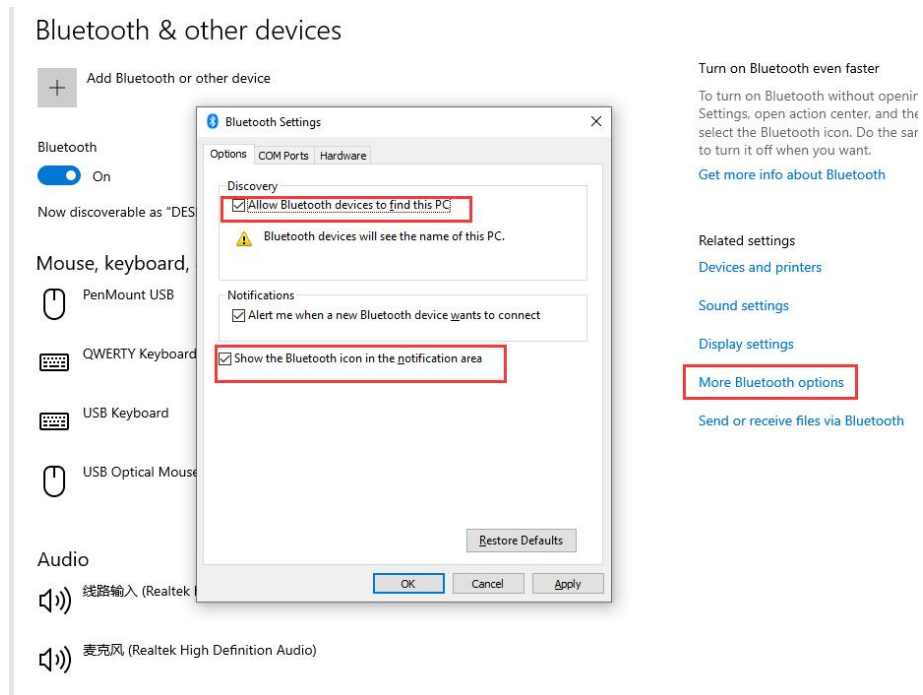

3.5 Bluetooth (Win7)

3.5.1 Turn on the Bluetooth

1. Click the Start button in the lower-left corner of your screen.



2. Type bluetooth settings in the search box, then select Change Bluetooth settings from the results.

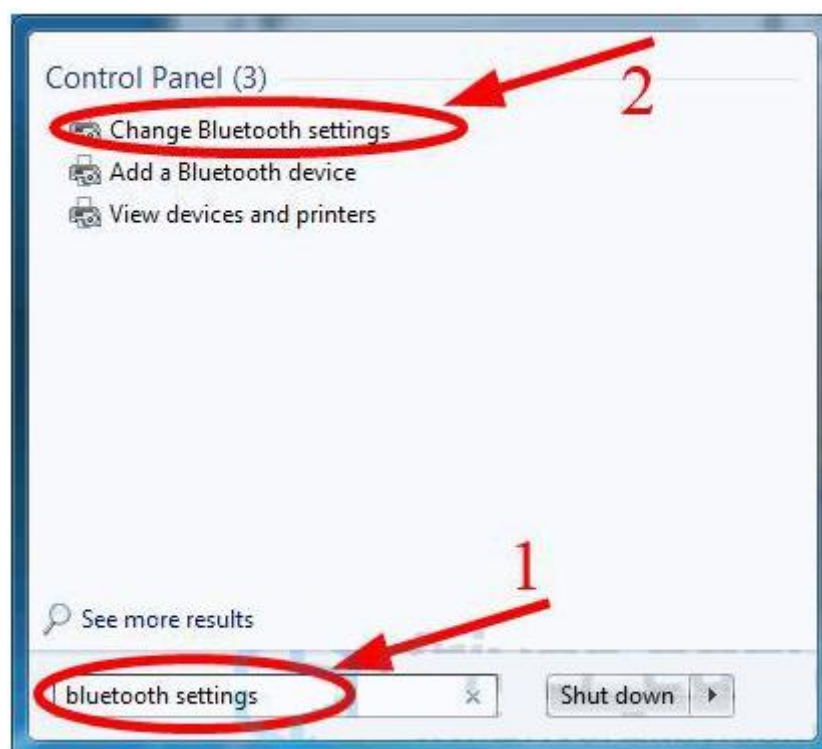

3. Make sure you check the boxes as the screenshot shown below, then click OK.

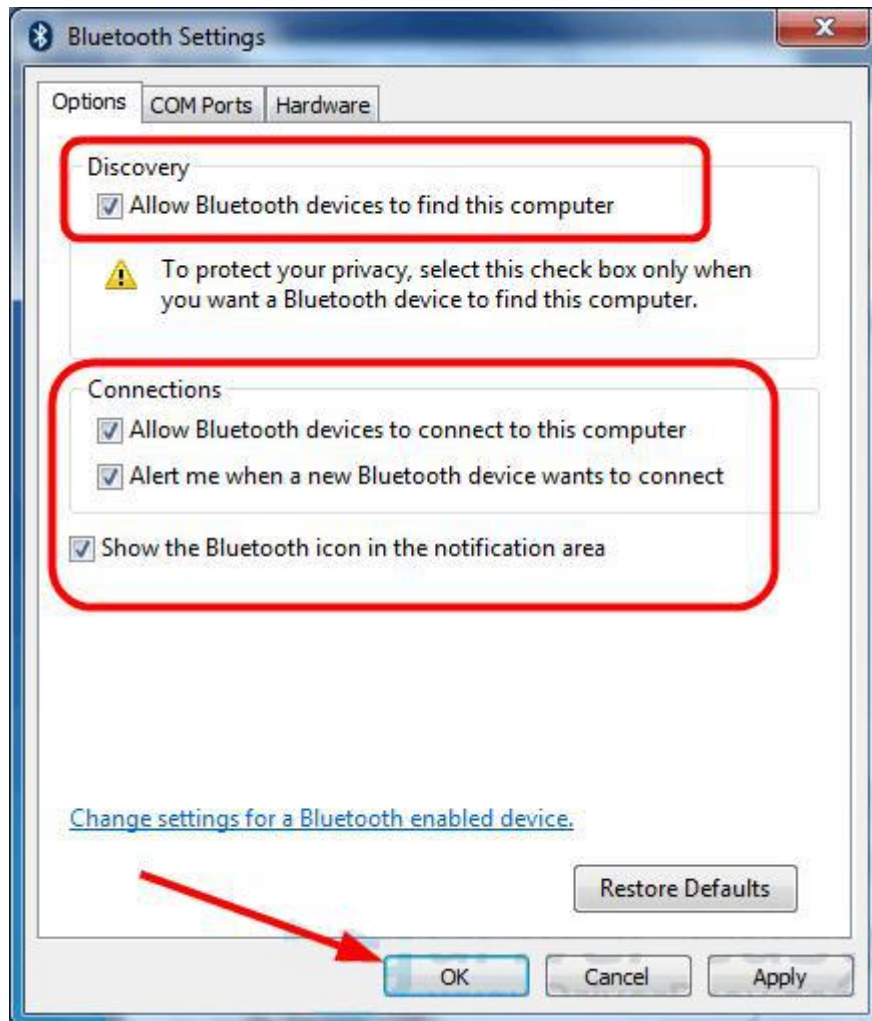

4. Click the little triangle icon on the bottom-right part of your screen, and you'll see the Bluetooth icon; it means you've turned on Bluetooth in VT-708K. Congratulations!

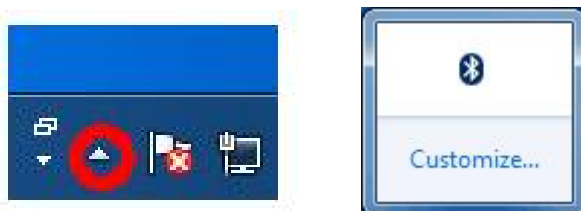

3.5.2 Connect to the Bluetooth

1. Turn on your Bluetooth device and make it discoverable. The way you make it discoverable depends on the device. Check the device or visit the manufacturer's website to learn how.
2. Select the **Start** button > **Devices and Printers**.
3. Select **Add a device** > select the device > **Next**.

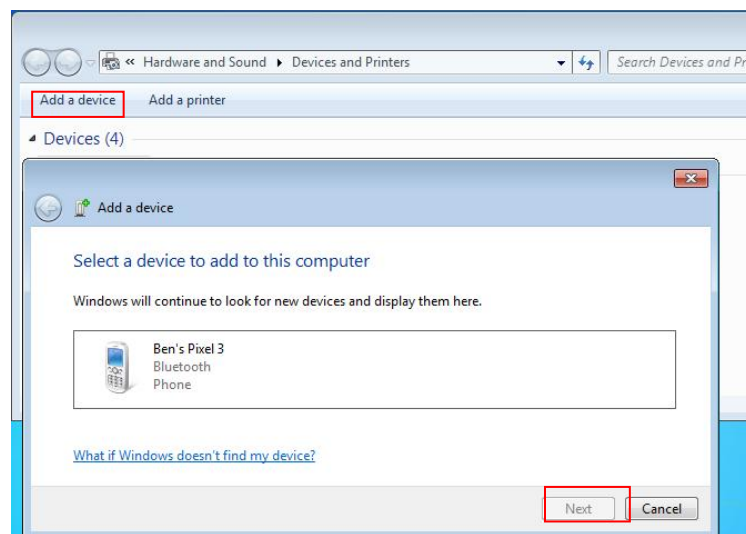

4. If you don't see your Bluetooth device here, ensure that it's discoverable and has Bluetooth enabled. As we mentioned above, this may require a certain button input on Bluetooth accessories like keyboards.

For many devices, you'll see a passcode. Ensure the key on VT-708K and the device are the same. This helps you ensure you're connecting the device to the correct machine, and not another nearby computer.

You'll have to agree to the pairing request to initiate the connection. When pairing a phone, you'll need to confirm the code on both your phone and your computer. A window will pop up asking you to confirm the connection. This helps prevent other people from pairing with your device when it's in discoverable mode.



Once you confirm, Windows may install drivers as needed. Then you' re all set to start using it.

3.6 4G/5G (Win10)

3.6.1 Installation of 4G SIM Card

1. Insert 4G LTE SIM card into VT-708K. The SIM card is standard size. SIM slot position is as follows.



SIM Slot

Note: Please ensure that the machine is completely powered off before inserting and removing the SIM card.

2. After installing SIM card, if the network can be connected normally, the installation is completed. If not, manually input the corresponding APN access points of SIM card operators.

3.6.2 4G setting

1. After installing SIM card. Left-click the Internet Icon. Click the **"Let Windows Keep Me Connected"** and Left-click the **"Connect"**. If your SIM card operator is **China Telecom**, click the **"Network & Internet Settings"** to further set up APN . The following picture appears.

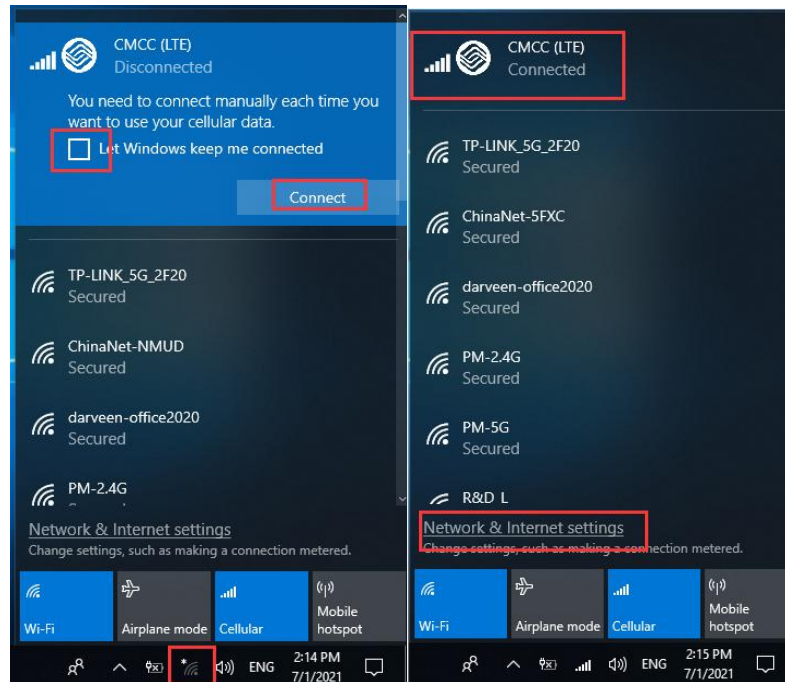

2. Select the **"cellular"** and click **"Advanced Options"** to set up the APN.

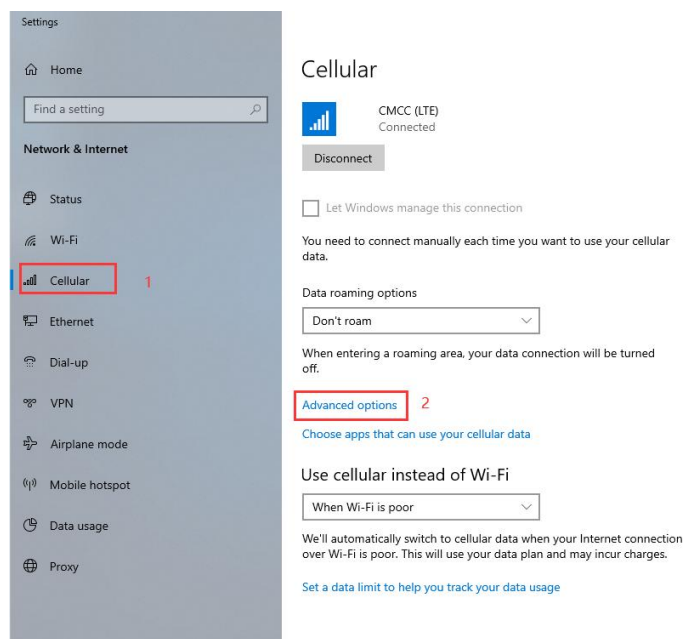

3. After entering the " **Advanced Options**", scroll down to " **APN Settings**" and click " **Add an APN** " .

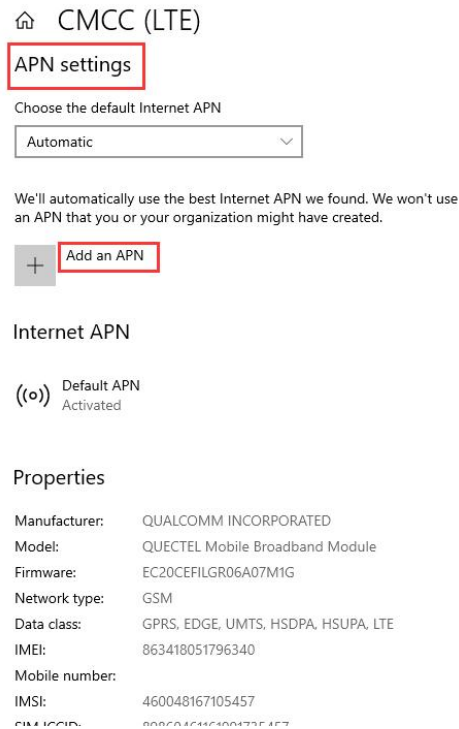

4. Add an APN for SIM card operator to access 4G networks. In China, The APN of each operator is different. China Mobile is " **cmnet**", China Unicom is " **3gnet**" and China Telecom is " **ctnet**".

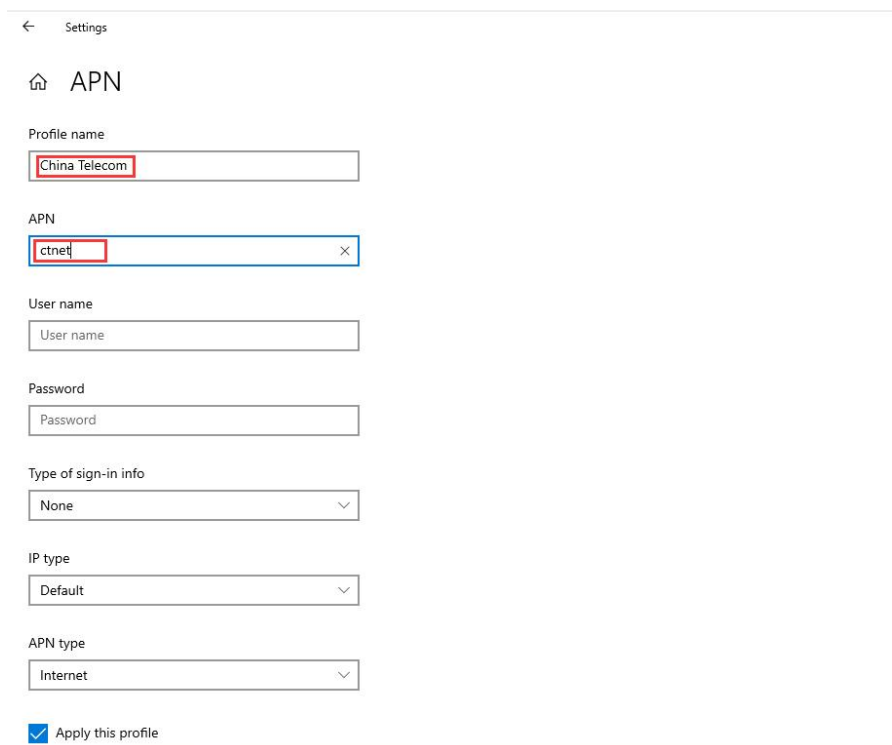

5. After completing the APN setting, power off and disconnect the power cable. Then plug in the power cables and reboot, and you'll be able to connect to the 4G network as normal.

3.7 4G/5G (Win7)

3.7.1 Installation of 4G SIM Card

1. Insert 4G LTE SIM card into VT-708K. The SIM card is standard size. SIM slot position is as follows.



Note: Please ensure that the machine is completely powered off before inserting and removing the SIM card.

2. After installing SIM card, if the network can be connected normally, the installation is completed. If not, manually input the corresponding APN access points of SIM card operators.

3.7.2 4G setting

After installing SIM card. Left-click the Internet Icon, The following picture appears. Left-click the “**Connect**”.

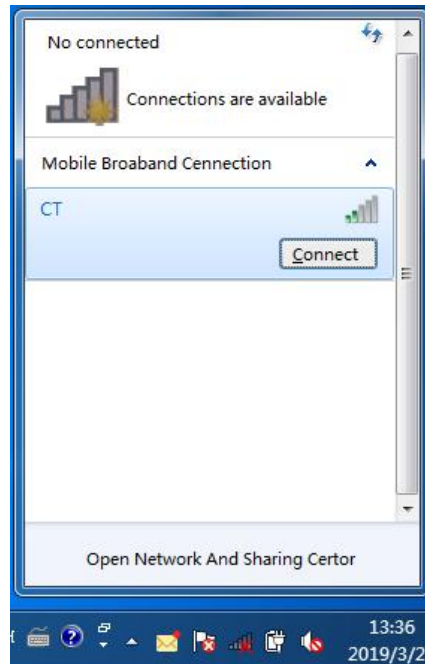

2. Single click the “Connect”, The following picture appears. The “APN(access point name)” must be filled in. Query APN of corresponding SIM card. In China, China Mobile is cmnet, China Unicom is 3gnet and China Telecom is ctnet. Neither “User name” nor “password” need to be filled in. Then click the “Continue”.

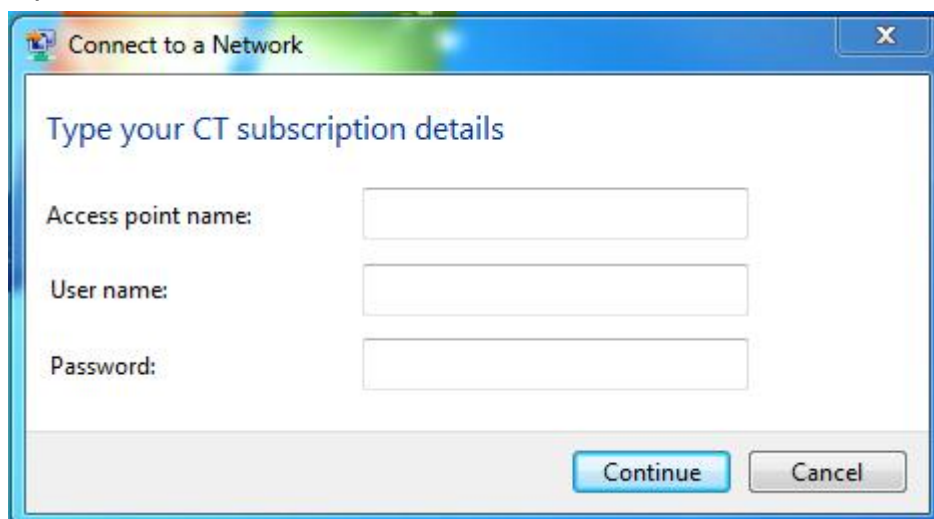

3. Automatic Connection Settings. There are three options: Connect automatically except when roaming, Always connect automatically, Never connect automatically. Then click the “Continue”.

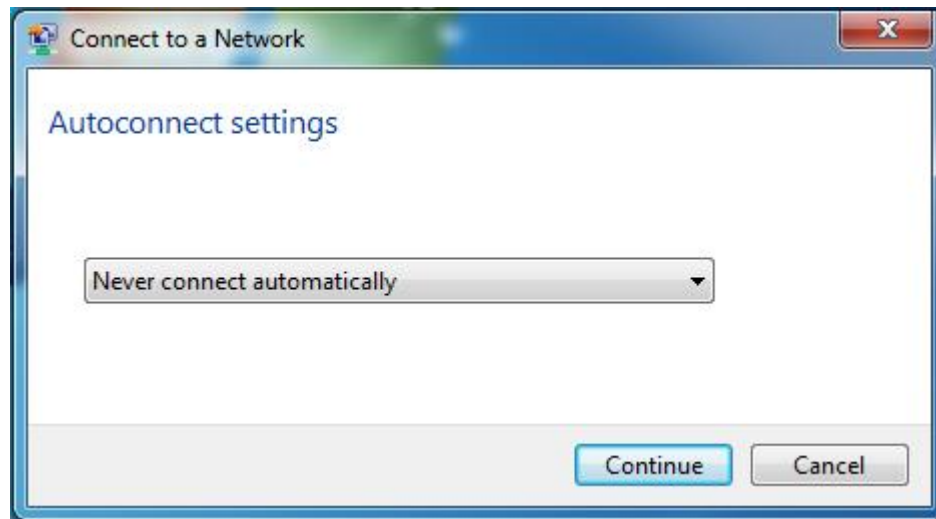

4. If the connection is successful, the following is displayed.

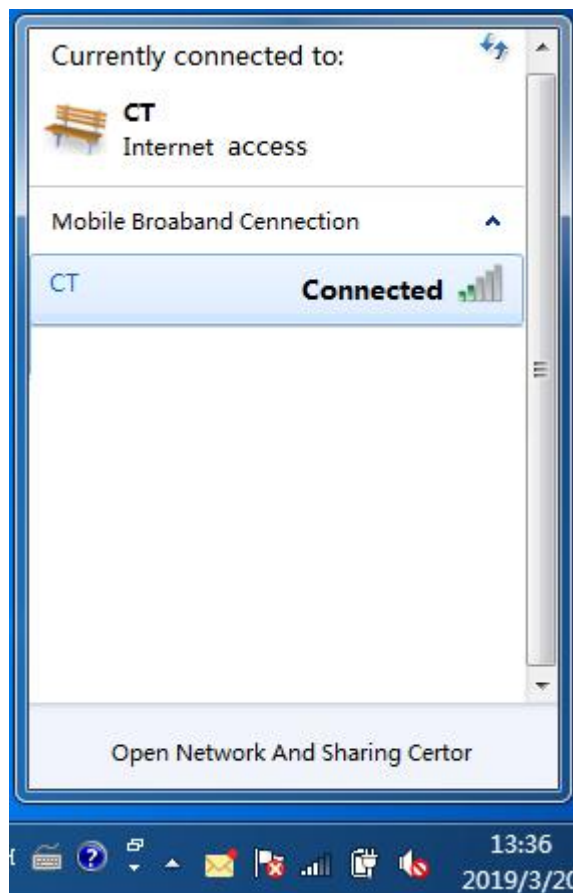

5.If you want to modify the APN or the Aotuconnect. Right-click Connect Network and select Properties.

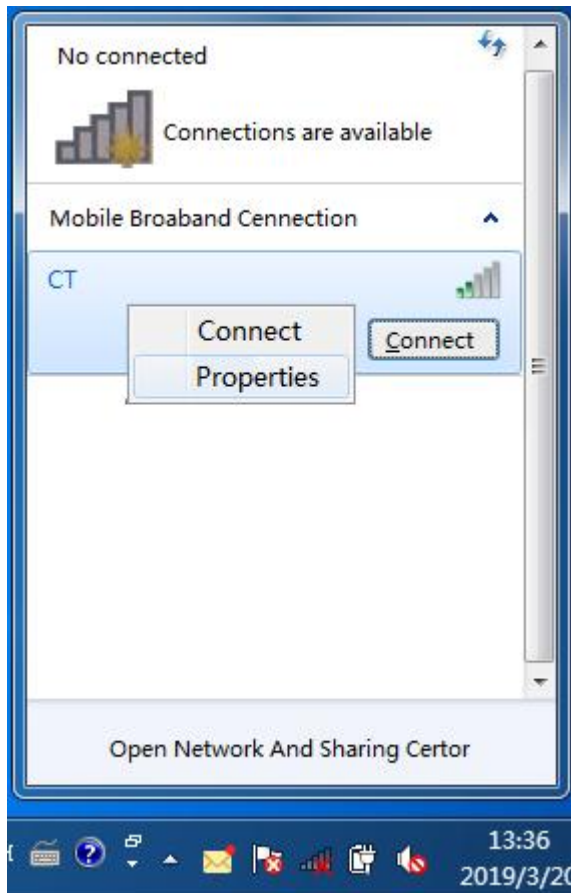

6. Modification in the **Profile**, Press OK key after modification. The network will be reconnected when the settings are completed.

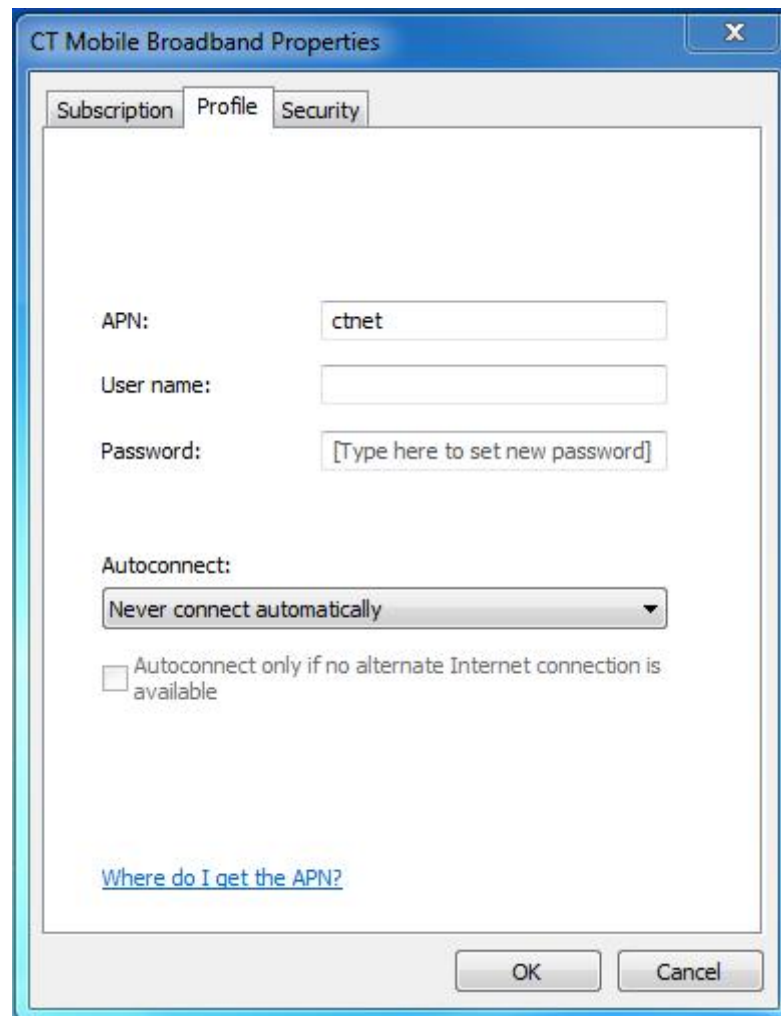

The image shows a Windows-style dialog box titled "CT Mobile Broadband Properties". It has three tabs: "Subscription", "Profile", and "Security". The "Profile" tab is selected. The dialog contains the following fields and options:

- APN: A text box containing "ctnet".
- User name: An empty text box.
- Password: A text box containing "[Type here to set new password]".
- Autoconnect: A dropdown menu currently showing "Never connect automatically".
- Below the dropdown is a checkbox labeled "Autoconnect only if no alternate Internet connection is available", which is currently unchecked.
- At the bottom left, there is a blue hyperlink that says "Where do I get the APN?".
- At the bottom right, there are two buttons: "OK" and "Cancel".

3.8 GPS

3.8.1 Guidelines for the Use of GPS

1. Install GPS antenna to VT-708K. You can buy antennas with better signals. Install those on the antenna interface.



2. The GPS module receives the signal and transmits it to the windows system by COM port. The baud rate is 9600bps. You can get GPS information by this serial port.

3.8.3 Analysis of incoming information

1. Input Information Display Window

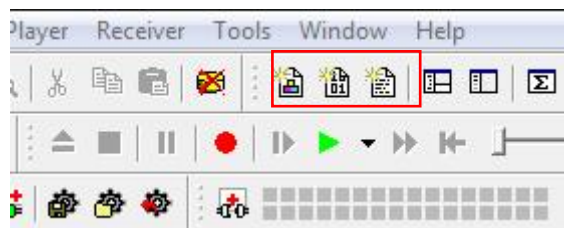

2. The Packet Console lists all incoming messages and provides information about message length and type.

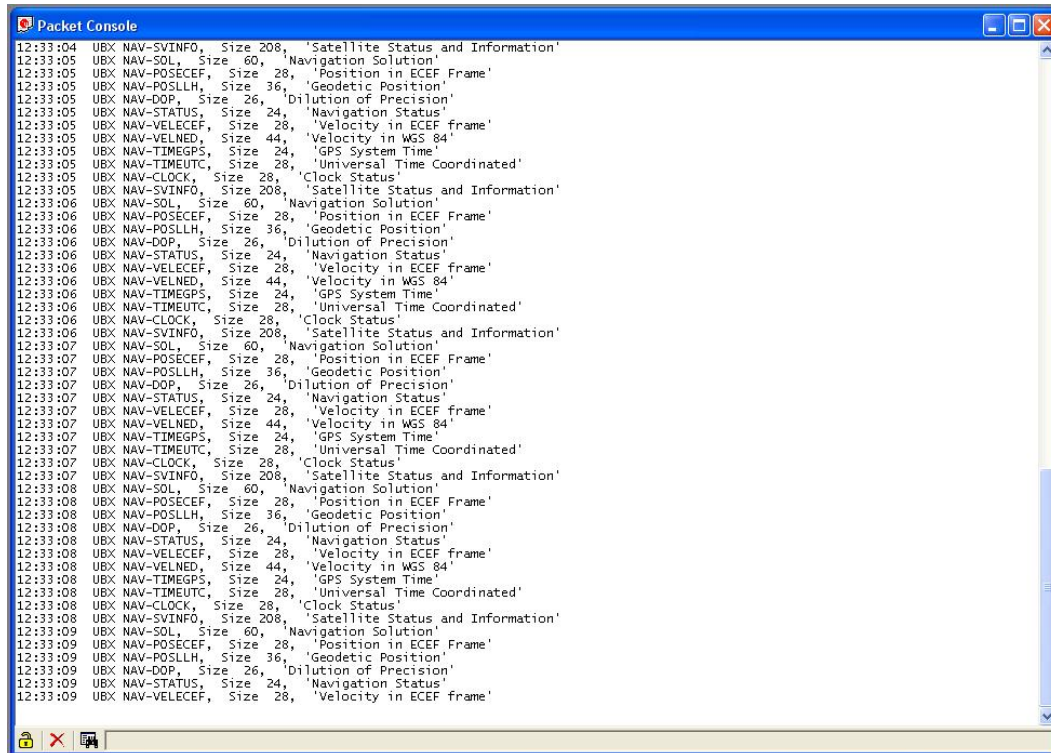



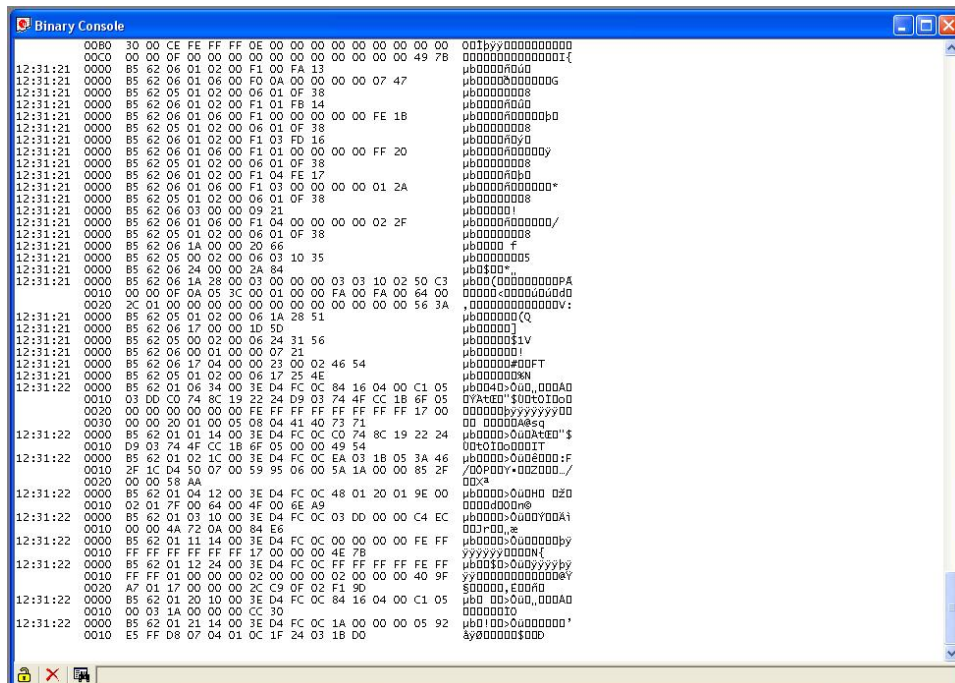

3. The Binary Console lists all incoming messages in binary and ASCII format.

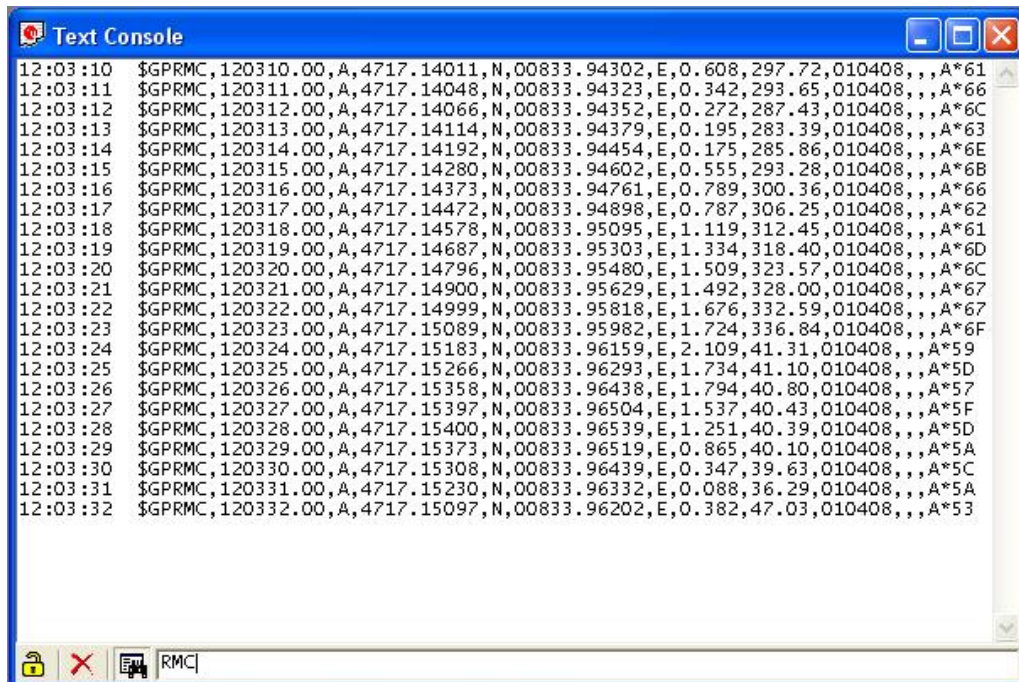
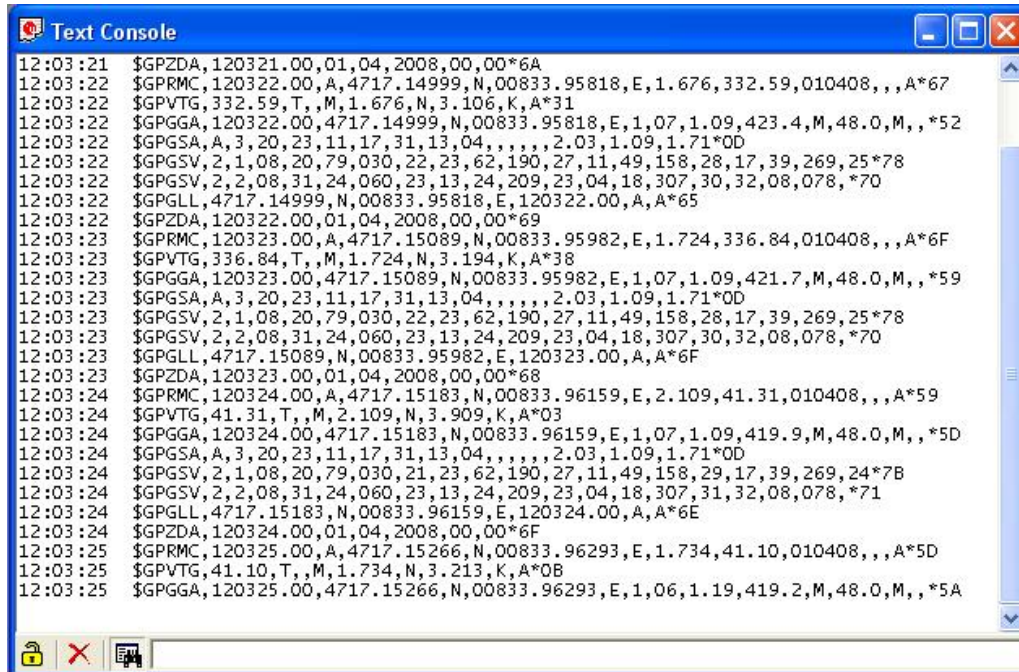

4. The Text Console displays the content messages in textual form such as UBX-INF or NMEA messages.

NMEA messages are shown with heading \$Gxyyy, where x stands for the satellite system (L=GLONASS N=GNSS P=GPS) and yyy for the type of message (e.g. ZDA=Time & Date).



Element	Name	Description
	Lock	Prevents the Text Console from being updated with new data when locked.
	Clear All	Erases all data in the Text Console
	Filter On/Off	Filter unwanted data from the data stream. This allows searching for certain expression, e.g. all RMC messages (Figure 19).

5. Regular expression evaluation

Normally, when you search for a sub-string in a string, the match should be exact. So if we search for a sub- string "abc" then the string being searched should contain these exact letters in the same sequence for a match to be found. We can extend this kind of search to a case insensitive search where the sub-string "abc" will find strings like "Abc", "ABC" etc. That is, the case is ignored but the sequence of the letters should be exactly the same. Sometimes, a case insensitive search is also not enough. For example, if we want to search for numeric digit, then we basically end up searching for each digit independently. This is where regular expressions come in to our help. Regular expressions are text patterns that are used for string matching. Regular expressions are strings that contain a mix of plain text and special characters to indicate what kind of matching to do. Here's a very brief tutorial on using regular expressions. Suppose, we are looking for a numeric digit then the regular expression we would search for is "[0-9]". The brackets indicate that the character being compared should match any one of the characters enclosed within the bracket. The dash (-) between 0 and 9 indicates that it is a range from 0 to 9. Therefore, this regular expression will match any character between 0 and 9, that is, any digit. If we want to search for a special character literally we must use a backslash before the special character. For example, the single character regular expression "\"*" matches a single asterisk. In the table below the special characters are briefly described. A regular expression search is case sensitive.

Character	Description
^	Beginning of the string. The expression "^A" will match an 'A' only at the beginning of the string.
[^	The caret (^) immediately following the left-bracket ([) has a different meaning. It is used to exclude the remaining characters within brackets from matching the target string. The expression "[^0-9]" indicates that the target character should not be a digit.
\$	The dollar sign (\$) will match the end of the string. The expression "abc\$" will match the sub-string "abc" only if it is at the end of the string.
	The alternation or logic OR character () allows either expression on its side to match the target string. The expression "a b" will match 'a' as well as 'b'.
.	The dot (.) will match any character.
*	The asterisk (*) indicates that the character to the left of the asterisk in the expression should match 0 or more times.
+	The plus (+) is similar to asterisk but there should be at least one match of the character to the left of the + sign in the expression.
?	The question mark (?) matches the character to its left 0 or 1 times.
()	The parenthesis affects the order of pattern evaluation.
[]	Brackets ([and]) enclosing a set of characters indicates that any of the enclosed characters may match the target character.

6.Example

Let's assume that the following lines would appear in the NMEA console without filtering.

```

14:00:03
$GPGGA,140003.242,4717.1126,N,00833.7862,E,1,06,1.3,543.0,M,,,,0000*09
14:00:03 $GPGLL,4717.1126,N,00833.7862,E,140003.242,A*34
14:00:03 $GPGSA,A,3,06,17,25,22,30,10,,,,,,,,,2.9,1.3,2.6*3A
14:00:03
$GPGSV,2,1,07,06,58,062,44,17,52,161,44,25,45,239,44,22,35,301,44*7F
14:00:03 $GPGSV,2,2,07,30,31,123,44,10,17,059,39,01,05,316,*4E
14:00:03
$GPRMC,140003.242,A,4717.1126,N,00833.7862,E,0.03,80.59,010201,,*36
14:00:03 $GPVTG,80.59,T,,M,0.03,N,0.1,K*56
14:00:04
$GPGGA,140004.242,4717.1126,N,00833.7862,E,1,06,1.3,542.0,M,,,,0000*0F

14:00:04 $GPGLL,4717.1126,N,00833.7862,E,140004.242,A*33
14:00:04 $GPGSA,A,3,06,17,25,22,30,10,,,,,,,,,2.9,1.3,2.6*3A
14:00:04
$GPGSV,2,1,07,06,58,062,45,17,52,161,44,25,45,239,44,22,35,301,44*7E
14:00:04 $GPGSV,2,2,07,30,31,123,44,10,17,059,39,01,05,316,*4E
14:00:04
$GPRMC,140004.242,A,4717.1126,N,00833.7862,E,0.02,152.96,010201,,*0D
14:00:04 $GPVTG,152.96,T,,M,0.02,N,0.0,K*6B

```

In the following examples the characters marked red match the regular expression.

Example 1: Searching for the RMC with a valid position and all GGA Messages
“GP(GGA|RMC,.*,A)”

```
14:00:03 $GPGGA,140003.242,4717.1126,N,00833.7862,E,1,06,1.3,543.0,M,,,,,0000*09
14:00:03 $GPRMC,140003.242,A,4717.1126,N,00833.7862,E,0.03,80.59,010201,,*36
14:00:04 $GPGGA,140004.242,4717.1126,N,00833.7862,E,1,06,1.3,542.0,M,,,,,0000*0F
14:00:04 $GPRMC,140004.242,A,4717.1126,N,00833.7862,E,0.02,152.96,010201,,*0D
```

Example 2: Searching for all GSV with the message index of ‘2’ or ‘3’ “GSV,*,[2-3],”

```
14:00:03 $GPGSV,2,2,07,30,31,123,44,10,17,059,39,01,05,316,*4E
14:00:04 $GPGSV,2,2,07,30,31,123,44,10,17,059,39,01,05,316,*4E
```

Example 3: Searching for all messages starting with \$GP, which have a ‘G’ in the message identifier but not at the first position

“^\\\$GP.+G.*,”

```
14:00:03 $GPGGA,140003.242,4717.1126,N,00833.7862,E,1,06,1.3,543.0,M,,,,,0000*09
14:00:03 $GPVTG,80.59,T,,M,0.03,N,0.1,K*56
14:00:04 $GPGGA,140004.242,4717.1126,N,00833.7862,E,1,06,1.3,542.0,M,,,,,0000*0F
14:00:04 $GPVTG,152.96,T,,M,0.02,N,0.0,K*6B
```

Example 4: Searching for all message having a checksum of which the higher nibble is 3 “*3.\$”

```
14:00:03 $GPGLL,4717.1126,N,00833.7862,E,140003.242,A*34
14:00:03 $GPGSA,A,3,06,17,25,22,30,10,,,,,2.9,1.3,2.6*3A
14:00:03 $GPRMC,140003.242,A,4717.1126,N,00833.7862,E,0.03,80.59,010201,,*36
14:00:04 $GPGLL,4717.1126,N,00833.7862,E,140004.242,A*33
14:00:04 $GPGSA,A,3,06,17,25,22,30,10,,,,,2.9,1.3,2.6*3A
```

3.8.2 GPS Connection

1. The software used is **u-center**. After a successful installation, u-center will start up as shown:

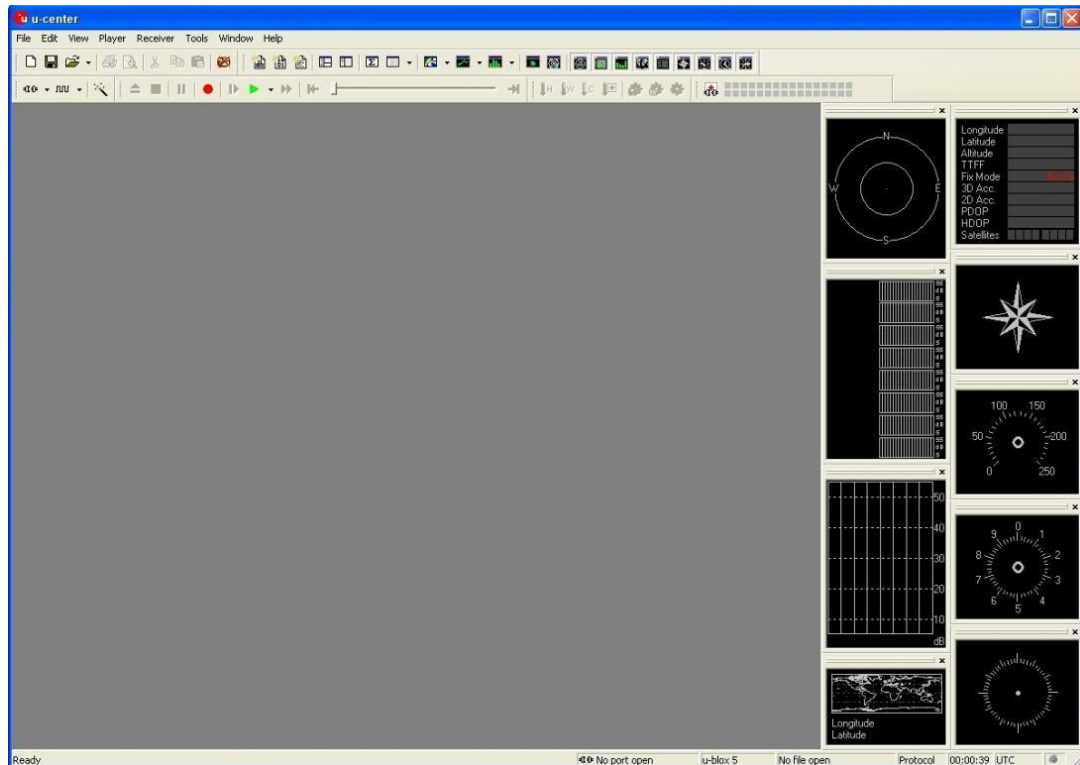

2. Configuring the serial connection. u-center stores the serial settings and uses the last configuration when started. When u-center is started for the first time, the COM port needs to be initialized. This is typically done in the Receiver Tool Bar.

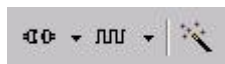

Connect/Disconnect-Button with COM-Port selection arrow



Baudrate-Button with baud rate selection arrow



Autobauding-button.

u-center only supports the COM-Settings listed below. All u-blox GPS/GNSS positioning chips and modules are pre-configured this way.

- Parity: None
- Data Bits: 8
- Stop Bits: 1
- Flow Control: none

1. COM-Port

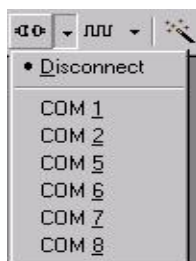

Press the arrow in the Connect/Disconnect-Button and select the virtual serial port number corresponding to GPS in Device Manager.

2. Baud rate

The baud rate can be manually set or automatically detected by using the autobauding feature. Press the arrow in the Baud rate-Button to manually select the baud rate. You can select the 9600bps.

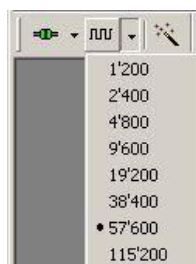

As soon as u-center is synchronized to the device, the Connect/Disconnect-Button on the Receiver Tool Bar changes color to green and the display shows information about the satellite constellation, signal to noise ratio, time etc. If the baud rate for u-center and the device are not set to the same value, the "Communication Information" icon changes to red.

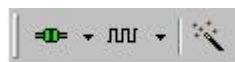

COM-Port and Baud rate successfully detected.

3. u-center support autobauding. If frequent break errors are detected, u-center will lower the baud rate, in case of framing errors, the baud rate is increased until no further errors are detected.



Autobauding-button.

4. If the device is working correctly, the display will show information about the satellite constellation, signal to noise ratio, time

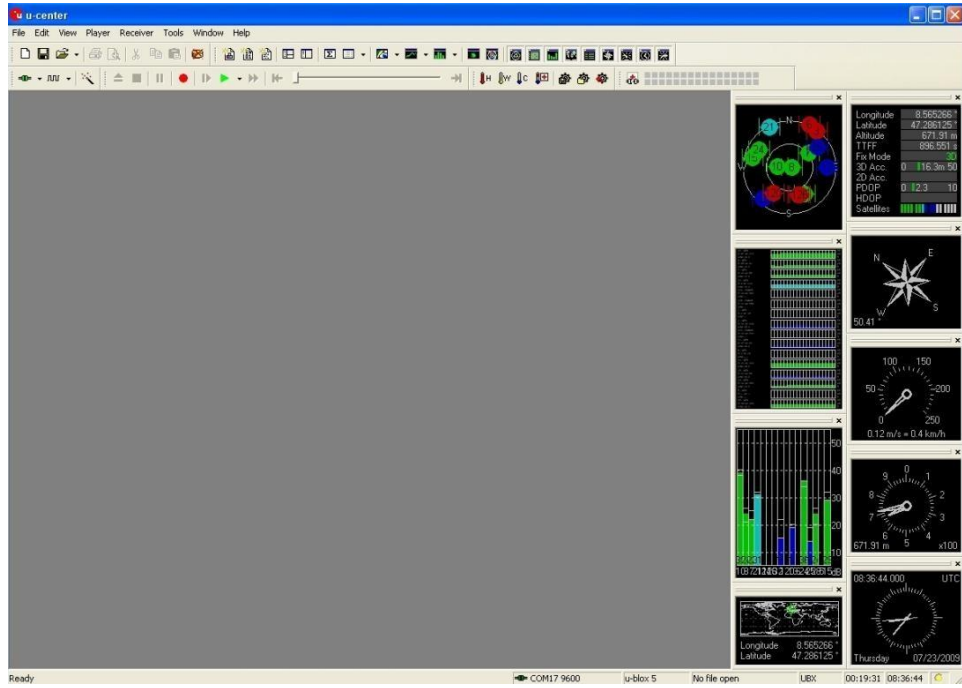

3.9 CAN

3.9.1 Basic CAN 2.0B Test Utility

You can use this GUI utility to test EMUC-B202 for sending/receiving basic CAN frames.

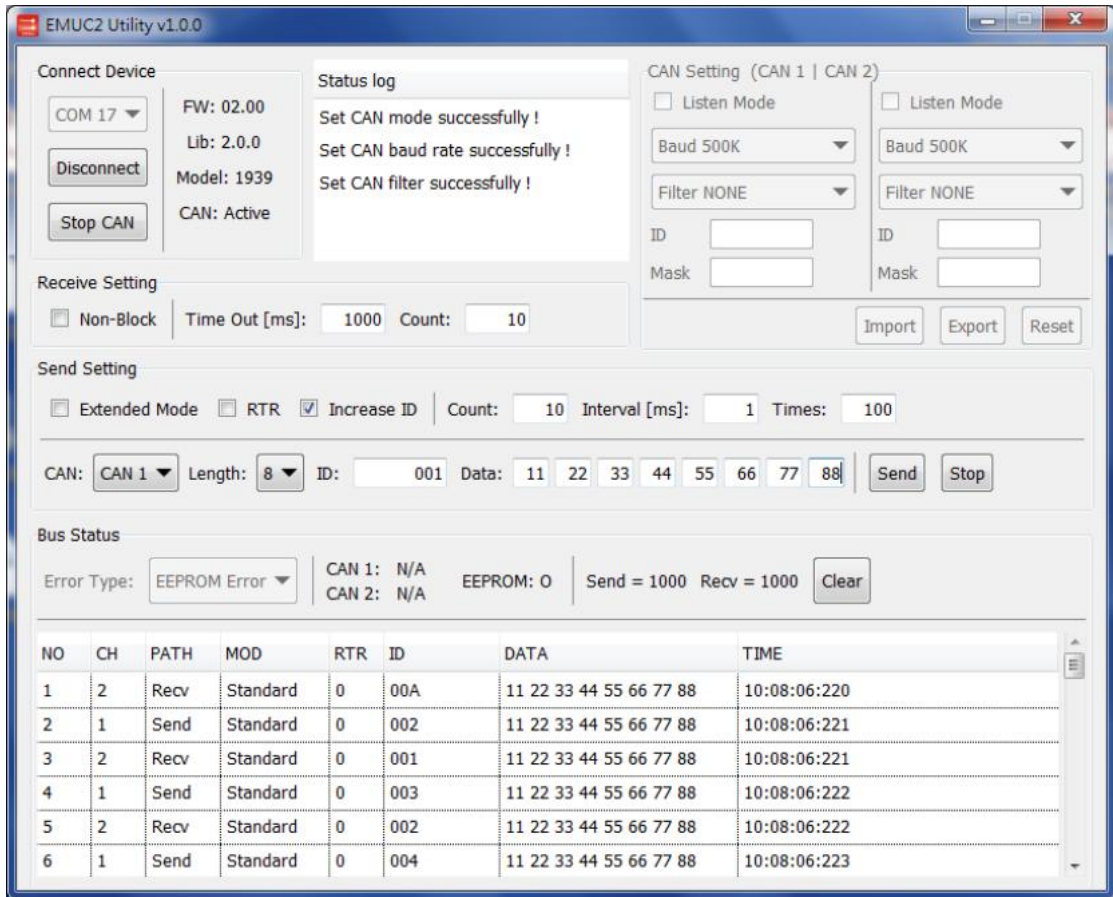

3.9.2 Connect Device

Select the COM port which is recognized as “**EMUC VCom Port**” in Device Manager, then click “**Connect**”.After connecting successfully, you will see the versions of firmware and library.

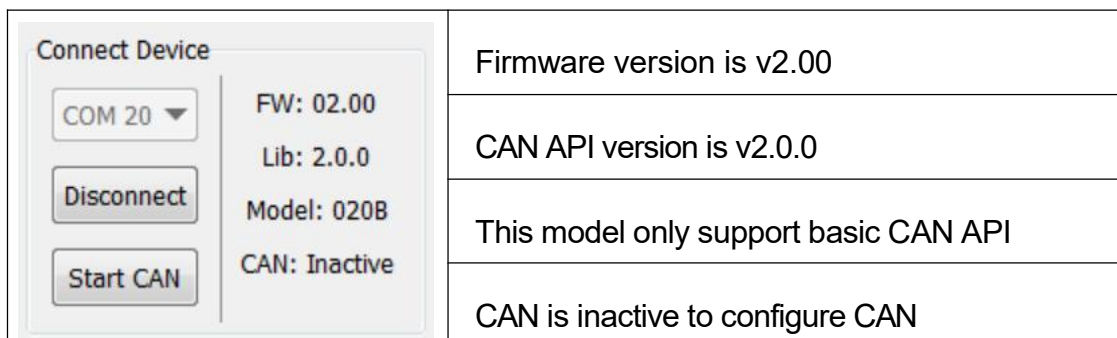

3.9.3 CAN Setting

NOTE: Only can be used when CAN is inactive.

In this section you can set CAN mode, baud rate, CAN acceptance filter, import/export CAN settings to a file, or reset all CAN settings to the default below.

Default Setting	
Baud Rate	500K
CANbus Mode	Normal Mode
Filter Type	None
Filter ID	None
Filter Mask	None
Error Setting	EEPROM only

Example:

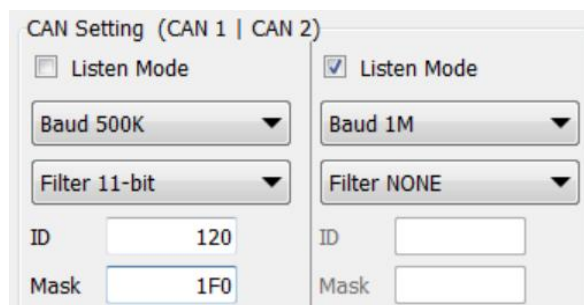

CAN1 is normal mode, baud rate is 500K, filter setting is 11bit, filtered id is 0x120, and filtered mask is 0x1F0. (Only receive CAN ID from 0x120 to 0x12F)
CAN2 is listen mode, baud rate is 1000K, and filtered setting is none.

3.9.4 Receive Setting

NOTE: Only can be used when CAN is active.

Enable non-block function to receive CAN frames. You can set the received conditions of "Time Out" or "Count". As long as one of the conditions is reached, the CAN frames are returned.

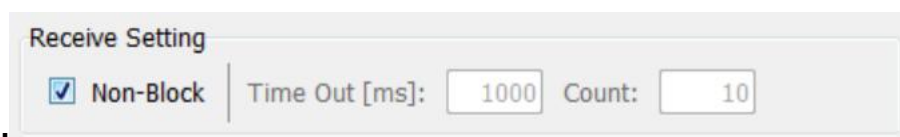

Example:

Non-block is enabled. Time Out is 1000ms (1 sec.), data count is 10. It means if receive 10 frames less then 1000ms, it will return 10 frames; if 1000ms time out but only receive 5 frames, it will return 5 frames.

3.9.5 Sending Setting

NOTE: Only can be used when CAN is active

Extended Mode: Check this checkbox to send EID (29bit) frames.

RTR: Check this checkbox to send RTR frames.

Increase ID: Check this check box to increase ID when “Count” setting > 1. **Count:** Amount of CAN frames you want to send. Leave blank to send one frame.

Interval: Sending interval of each CAN frame when “Count” setting > 1.

Times: Amount of repetitions you want to send CAN frames.

Example:

Set 29bit ID without RTR and increased ID when sending next frame.

Send 10 frames with interval 1ms for each frame and repeat 100 times. It will send is 1000 frames totally.

NO	CH	PATH	MOD	RTR	ID	DATA	TIME
1	1	Send	Extended	0	00000001	11 22 33 44 55 66 77 88	15:35:05:796
2	1	Send	Extended	0	00000002	11 22 33 44 55 66 77 88	15:35:05:797
3	1	Send	Extended	0	00000003	11 22 33 44 55 66 77 88	15:35:05:798
4	1	Send	Extended	0	00000004	11 22 33 44 55 66 77 88	15:35:05:799
5	1	Send	Extended	0	00000005	11 22 33 44 55 66 77 88	15:35:05:800
6	1	Send	Extended	0	00000006	11 22 33 44 55 66 77 88	15:35:05:801

3.10 Power Management of ACC

3.10.1 Delay time setting of ACC ON/OFF

1. Insert the keyboard, Restart the VT-708K and press "Delete" come to the BIOS.
2. In the BIOS, select Power Management of the Advanced.

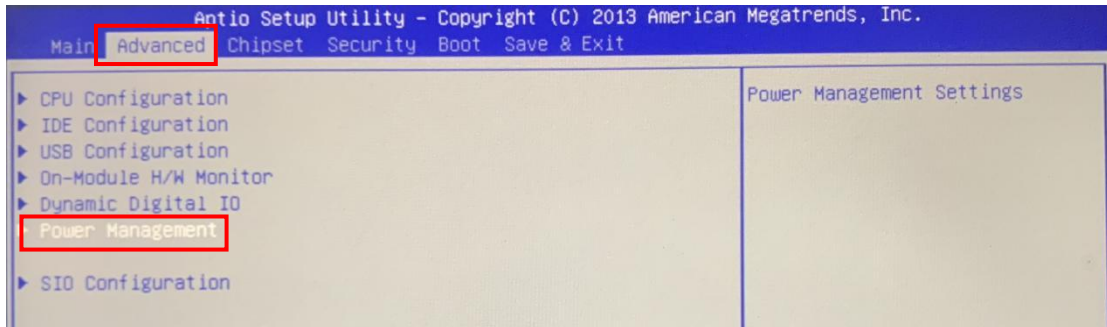

3. "Custom ACC ON Delay Time" and "Custom ACC OFF Delay Time" is setting the delay time.

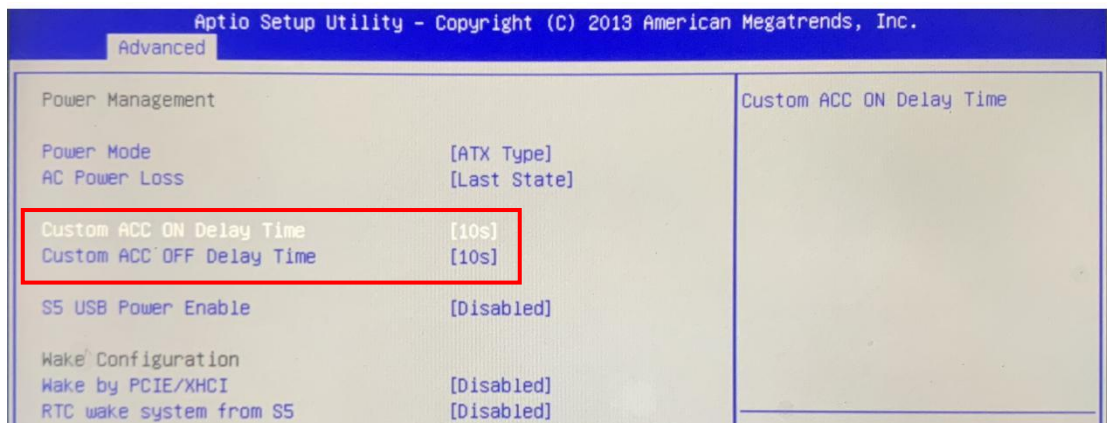

4. In the Custom ACC ON Delay Time, You can setting the delay time between 2 and 60 seconds.

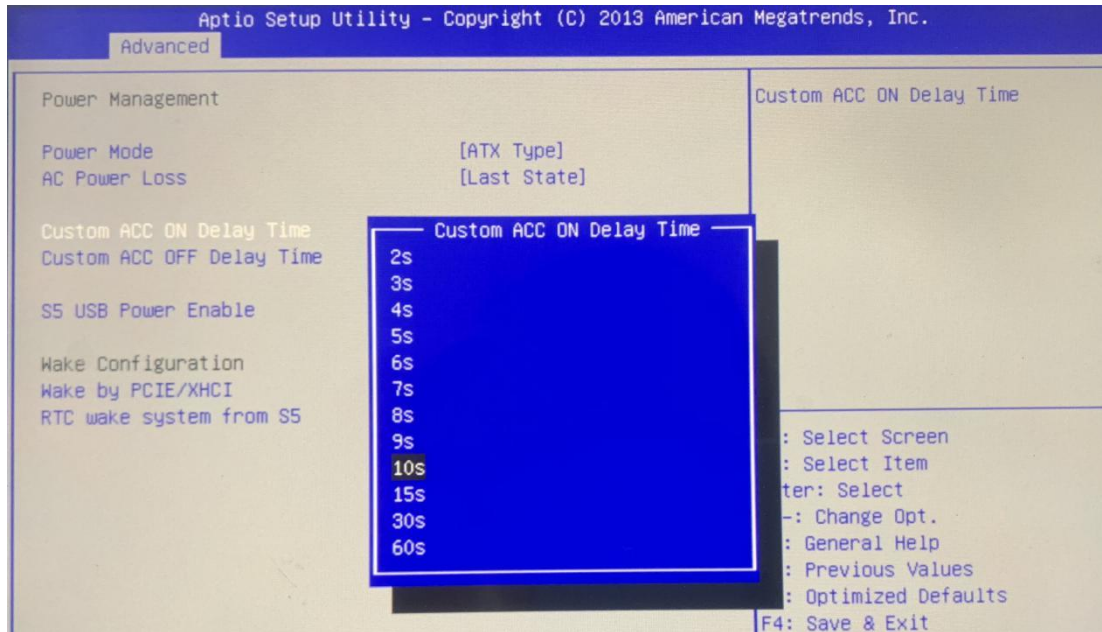

5. In the Custom ACC OFF Delay Time, You can setting the delay time between 2 and 120 seconds.

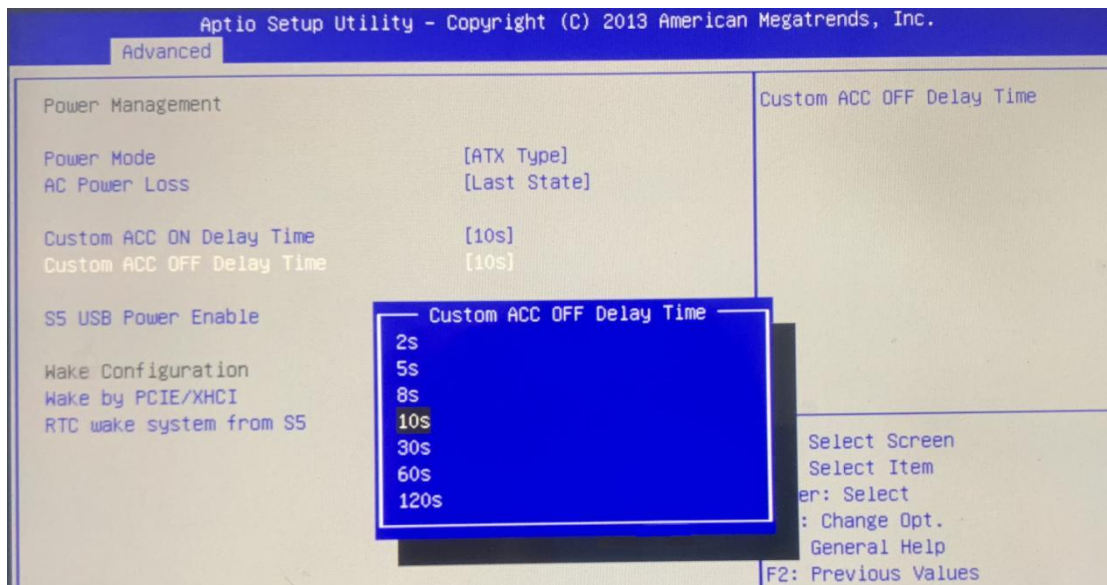

6. Pressing the F4 to exit and save, when setting finish.



Chapter4. Accessories and Power connection

4.1 Check the package

Open the package and check all the parts are inside without shortage and damage:





A. VT-708K (Main Unit)









Standard package is including a VT-708K main unit and a power cable.

1	Main unit	VT-708K	
2	Power cable	PC-03M-20-ACC	

B. Accessories (Optional)

According to the use of different environment, you can choose some different parts, the list is as below:

1	Power Adapter	PWR220A12-M12 * AC-DC Adapter * 100~240Vac Input, 12V/5A dc Output	
2		PWR836D512-M12 * DC-DC Adapter * 8~36Vdc Input, 12V/3A and 5V/2A Output	
3		PWR3672D512-M12 * DC-DC Adapter * 36~72Vdc Input, 12V/3A and 5V/2A Output	
4	Mounting Kits	RAM-MOUNT-02 * Universal Adjustable * Marine Grade Aluminum * VESA Standard (75x75mm and 100x100mm)	

5		<p>DV-MOUNT-1002</p> <ul style="list-style-type: none"> * Forklift Roof Mounting Kits * Universal Adjustable * Marine Grade Aluminum * VESA Standard (75x75mm and 100x100mm) 	
6		<p>DV-MOUNT-2002</p> <ul style="list-style-type: none"> * Forklift U-shaped Mounting Kits * Universal Adjustable * Marine Grade Aluminum * VESA Standard (75x75mm and 100x100mm) 	
7		<p>DV-MOUNT-60</p> <ul style="list-style-type: none"> * Lifting Mounting Kits * Stainless Steel Material * Lifting Height Adjustable Range 50~100cm * VESA Standard Holes(75x75mm & 100x100mm) 	
8	Power cable	PC-03M-20-ACC	
9		PC-23MM-20	
10		PC-23MM-20-ACC	
11	Antenna	<p>Rubber Duck Antenna</p> <p>ANT-R3S</p> <p>SMA(Female), 3dB, Universal</p>	
12		<p>Rubber Duck Antenna</p> <p>ANT-R3T</p> <p>TNC(Female), 3dB, Universal</p>	
13		<p>Rubber Duck Antenna</p> <p>ANT-R4T</p> <p>TNC(Female), 2~4dB, Cisco</p>	

14		<p>Magnetic Mount Antenna ANT-S7S SMA(Female), 7dB, 5meters long</p>	
15		<p>Magnetic Mount Antenna ANT-S7T TNC(Female), 7dB, 5meters long</p>	
16		<p>Fiberglass Antenna ANT-G5N N(Female), 5dB, 0.3meters long</p>	
17		<p>GPS Antenna ANT-GPSS SMA(Female), 3meters cable, GPS</p>	
18		<p>GPS Antenna ANT-GPST TNC(Female), 3meters cable, GPS</p>	
19		<p>GPS Antenna ANT-GNSSS SMA(Female), 3meters cable, GPS&GNSS</p>	
20		<p>GPS Antenna ANT-GNSST TNC(Female), 3meters cable, GPS&GNSS</p>	
21	Industrial Keyboard	<p>DKB-70 * 70 Keys QWERTY Full-function Keyboard * LED Backlight, Independent Switch Control * F1-F20 Function Keys, 0-9 Numeric and A-Z Alpha Keys * IP65 Waterproof * Support Windows and Andriod Operating System</p>	

22		Keyboard Mounting Bracket BK-VT1	
----	--	---	---

4.2 Power Connection

4.2.1 Power Options

Before using the VT-708K, choose different power adapters for different vehicle power.

Power Options including:

- **12 VDC Vehicles** (8-36VDC Direct Connection) – Direct connection to vehicle power.
- **24 VDC Vehicles** (8-36VDC Direct Connection) – Direct connection to vehicle power.
- **48 VDC Vehicles** – Requires the use of a DC-DC power supply.
- **80 VDC Vehicles** – Requires the use of a DC-DC power supply.
- **External AC/DC Power Supply** – For use when DC power supply is not available to power the VT-708K, such as in an office environment.

4.2.2 Power Cable Identification

PC-03M-20-ACC

Power cable with **straight connector** and **4 wires**, **2 meters** long:

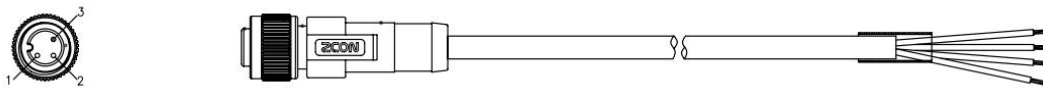

M12 Connector	Wire Color	Connection
P1	Red	DC+ (8-36 VDC)
P2	Yellow Green	Ignition Input (Optional)
P3	Black	DC-
Case	Black	Ground

Note: PC-03M-20-ACC cable is use for direct connection from vehicle power to VT-708K or DC-DC power input.

PC-23MM-20

Power cable with **straight connector**, **2 meters** long:

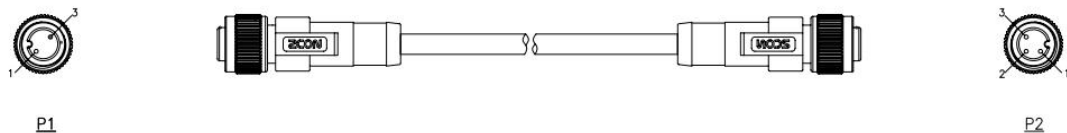

M12 Connector(P1)	M12 Connector(P2)	Connection
P1	P1	DC+ (8-36 VDC)
(NC)	P2	Ignition Input (Optional)
P3	P3	DC-
Case	Case	Ground

Note: PC-23MM-20 cable is use for connection from VT-708K to DC-DC power output, just without power ignition function.

PC-23MM-20-ACC

Power cable with **straight connector** and **1 wire, 2 meters** long:

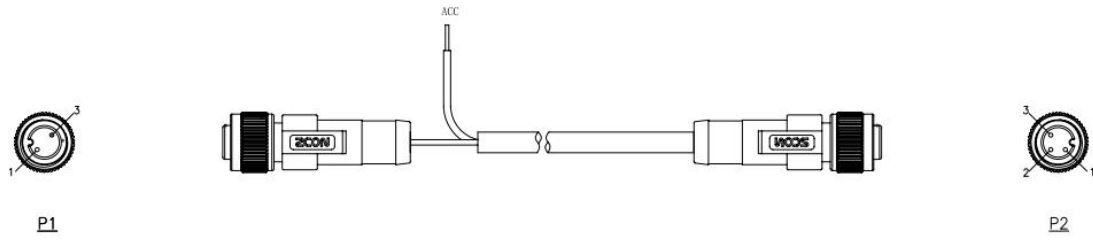

M12 Connector(P1)	M12 Connector(P2)	Connection
P1	P1	DC+ (8-36 VDC)
(Yellow)	P2	Ignition Input (Optional)
P3	P3	DC-
Case	Case	Ground

Note: PC-23MM-20 cable is use for connection from VT-708K to DC-DC power output, also with power ignition function.

4.2.3 External Power Adapter Options

1. External AC-DC Power Supply

PWR220A12-M12

The optional external AC/DC power supply is for use in environments, such as an office, where DC power is not available.

PWR220A12-M12 is support 100V-240V ac input, provide 12V dc and 5A power output, the power connector is an M12 male type which can meet IP65 dust and water proof.

Note: The Darveen-approved AC/DC Power Supply and Adapter Cable are only intended for use in a 25°C (77°F) maximum ambient temperature environment.

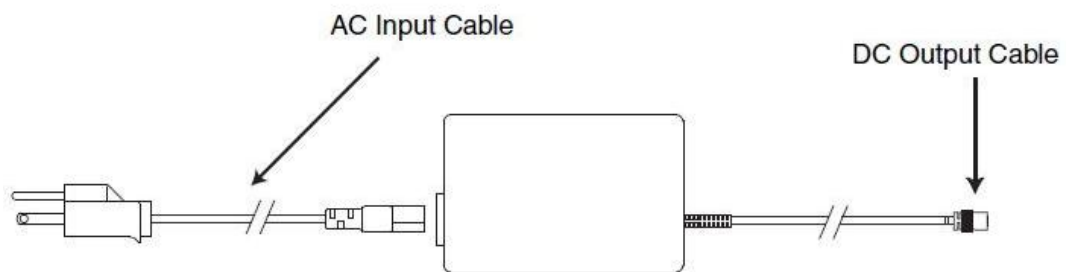

Connect External AC/DC Power Supply

1. Connect the provided detachable cord set (all others must order cable separately) to the external power supply.
2. Plug cord set into appropriate, grounded, electrical supply receptacle (AC mains).
3. Connect the watertight connector end of the Adapter Cable to the VT-708K Power Connector by aligning the connector pins to the power connector; push down on the watertight connector and twist it to fasten securely.
4. Press the Power Button on the front of the VT-708K to turn on the VT-708K.

2. External DC-DC Power Supply

PWR836D512-M12

PWR836D512-M12 is an optional external DC/DC power supply, that is for use in vehicles provided 12V dc or 24V dc power. The power input and output connectors are M12 male type which can meet IP65 dust and water proof.

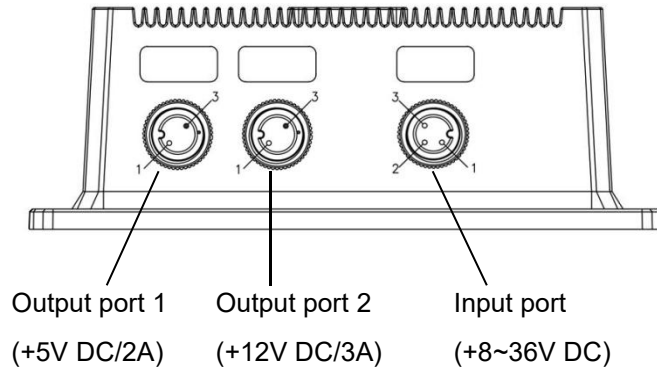

Input Port		Output Port 1		Output Port 2	
Pin	Signal	Pin	Signal	Pin	Signal
1	DC In+ (8-36 VDC)	1	DC Out+ (+5V/2A)	1	DC Out+ (+12V/3A)
2	NC	3	DC Out-	3	DC Out-
3	DC In-				

PWR3672D512-M12

PWR3672D512-M12 is an optional external DC/DC power supply, that is electronic isolation for use in the vehicles provided 48V dc power. The power input and output connectors are M12 male type which can meet IP65 dust and water proof.

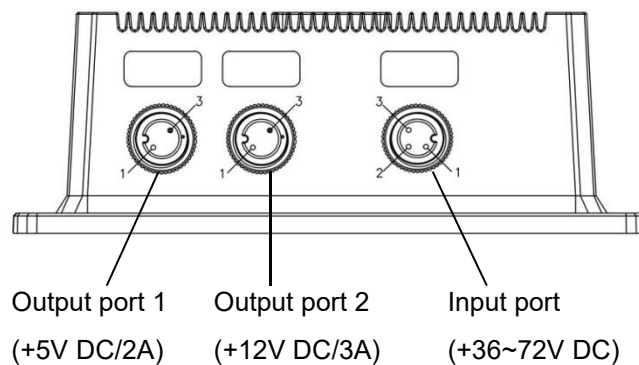

Input Port		Output Port 1		Output Port 2	
Pin	Signal	Pin	Signal	Pin	Signal
1	DC In+ (36-72 VDC)	1	DC Out+ (+5V/2A)	1	DC Out+ (+12V/3A)
2	NC	3	DC Out-	3	DC Out-
3	DC In-				

4.2.4 12-24 VDC Vehicles (8-36VDC Direct Connection)



Fuse Requirements:

WARNING - For proper and safe installation, the input power cable must be connected to a fused circuit on the vehicle. If the supply connection is made directly to the battery, the fuse should be installed in the positive lead within 5 inches of the battery's positive (+) terminal. The fused circuit requires a maximum time delay (slow blow) fuse with a current rating as noted below.

- For **12VDC** input, use a 10A slow blow fuse that has a DC voltage rating greater than 12VDC.
- For **24VDC** input, use a 6A slow blow fuse that has a DC voltage rating greater than 24VDC.

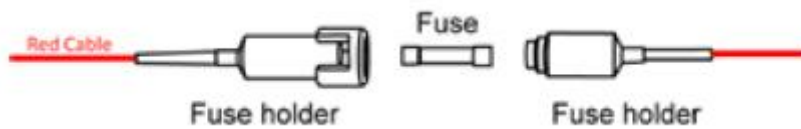

1. Connected vehicle directly.

(1) Use the ignition ON/OFF function.

Connect the watertight connector end of the power cable to the VT-708K power connector by aligning the connector pins to the power connector, push down on the watertight connector and twist it to fasten securely.

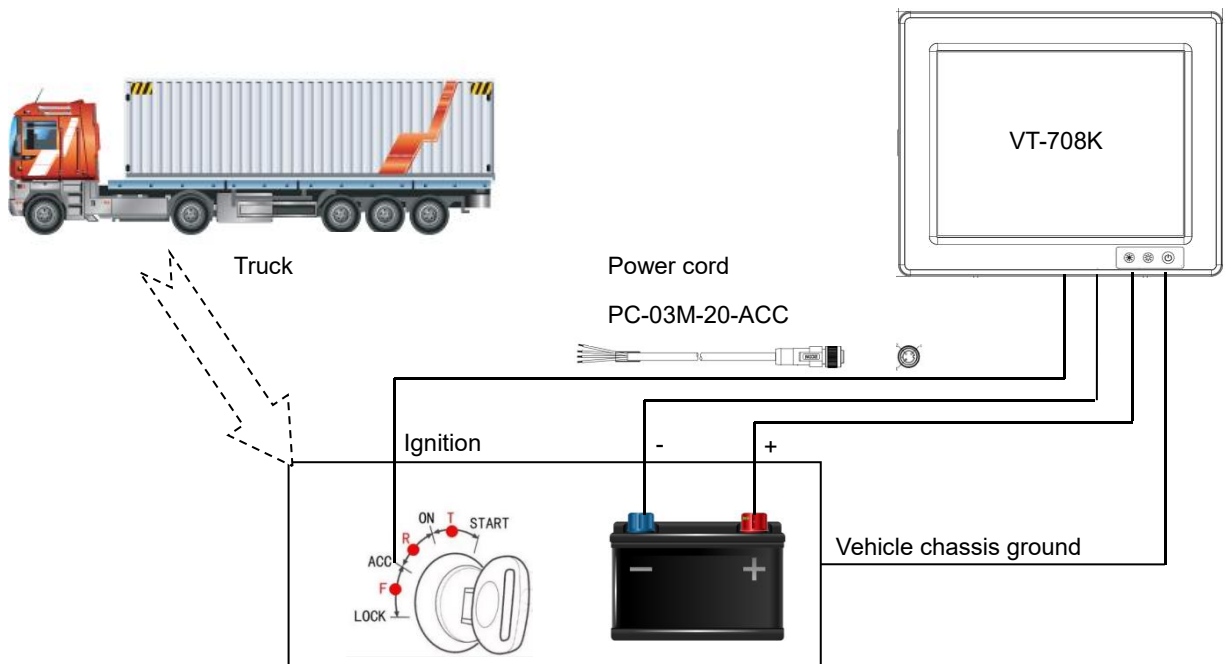

(2) Without the ignition ON/OFF function.

- a. Cut off the yellow wire (Ignition wire) on the power cord (PN: PC-03M-20-ACC);
- b. Connect the watertight connector end of the power cable to the VT-708K power connector by aligning the connector pins to the power connector, push down on the watertight connector and twist it to fasten securely.

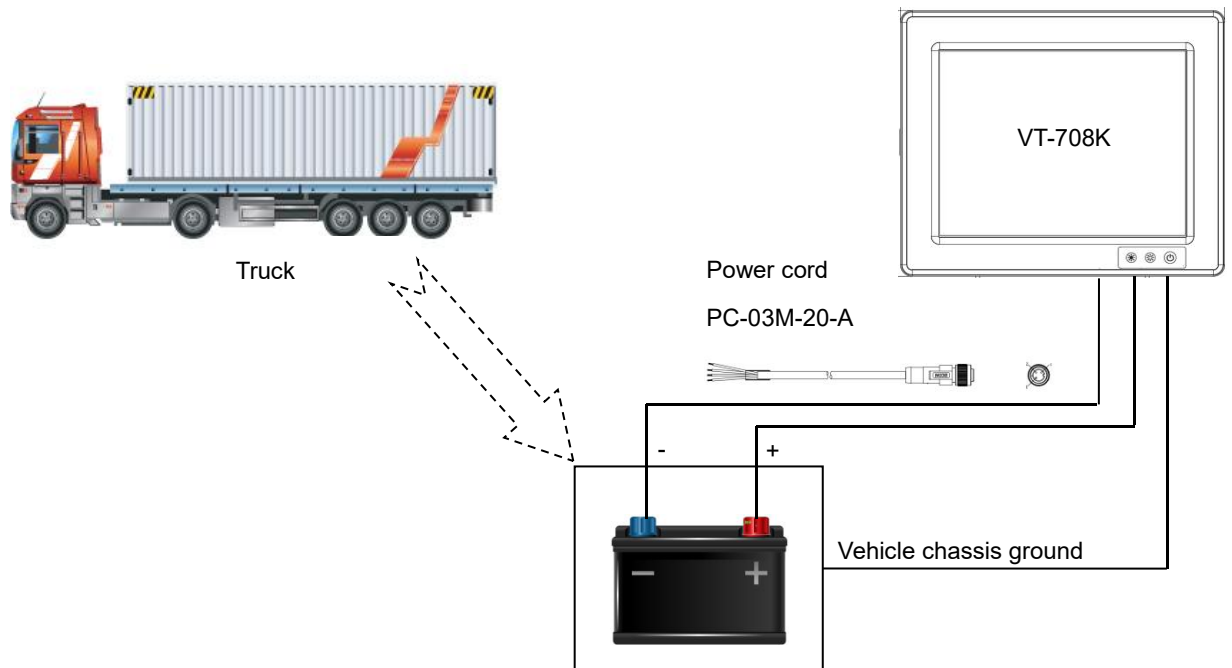

2. Connected vehicle via DC-DC power adapter.

(1) Use the ignition ON/OFF function.

- a. Connect the watertight connector end of the power cable (PC-03M-20-ACC) to the PWR836D512-M12 power connector by aligning the connector pins to the power connector, push down on the watertight connector and twist it to fasten securely.
- b. Connect the watertight connector end of the power cable (PC-23MM-20-ACC) to VT-708K and PWR836D512-M12, then connect the yellow wire (ignition wire) to the vehicle ignition signal pin.

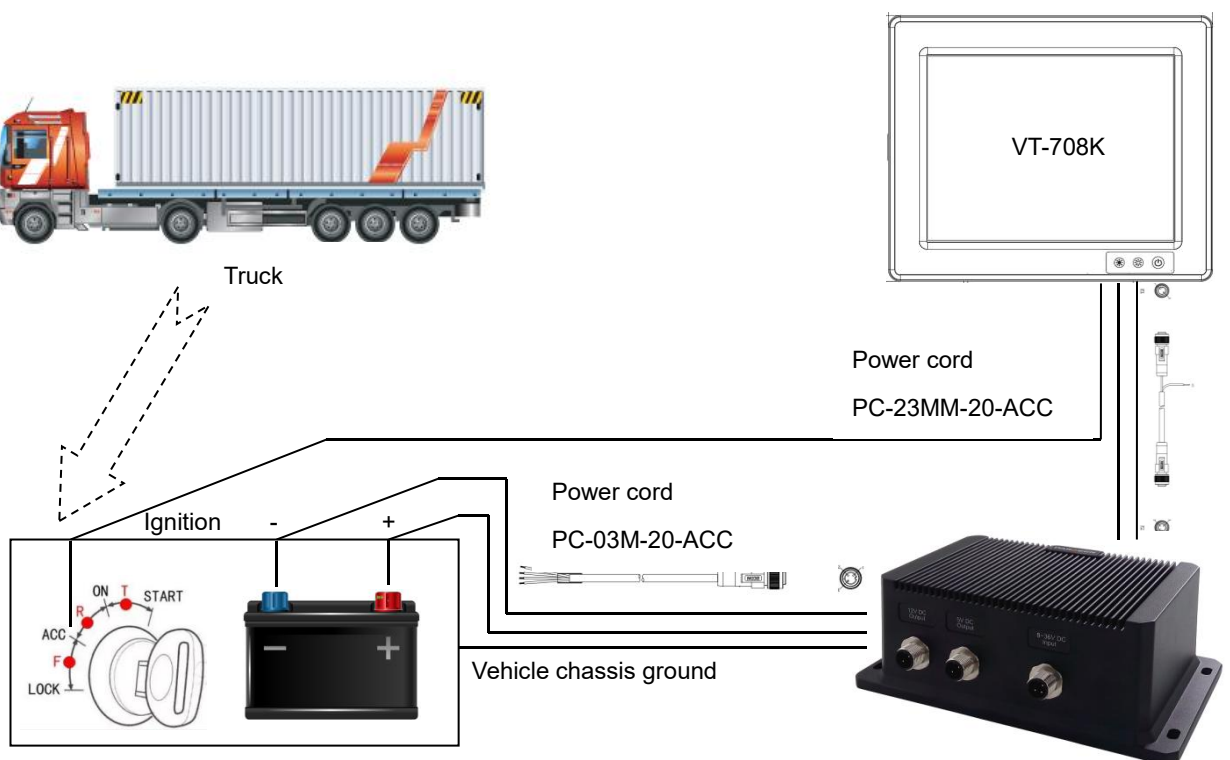

(2) Without the ignition ON/OFF function.

- a. Cut off the yellow wire (Ignition wire) on the power cord (PN: PC-03M-20-ACC);
- b. Connect the watertight connector end of the power cable (PC-03M-20-ACC) to the PWR836D512-M12 power connector by aligning the connector pins to the power connector, push down on the watertight connector and twist it to fasten securely.
- c. Connect the watertight connector end of the power cable (PC-23MM-20) to VT-708K and PWR836D512-M12.

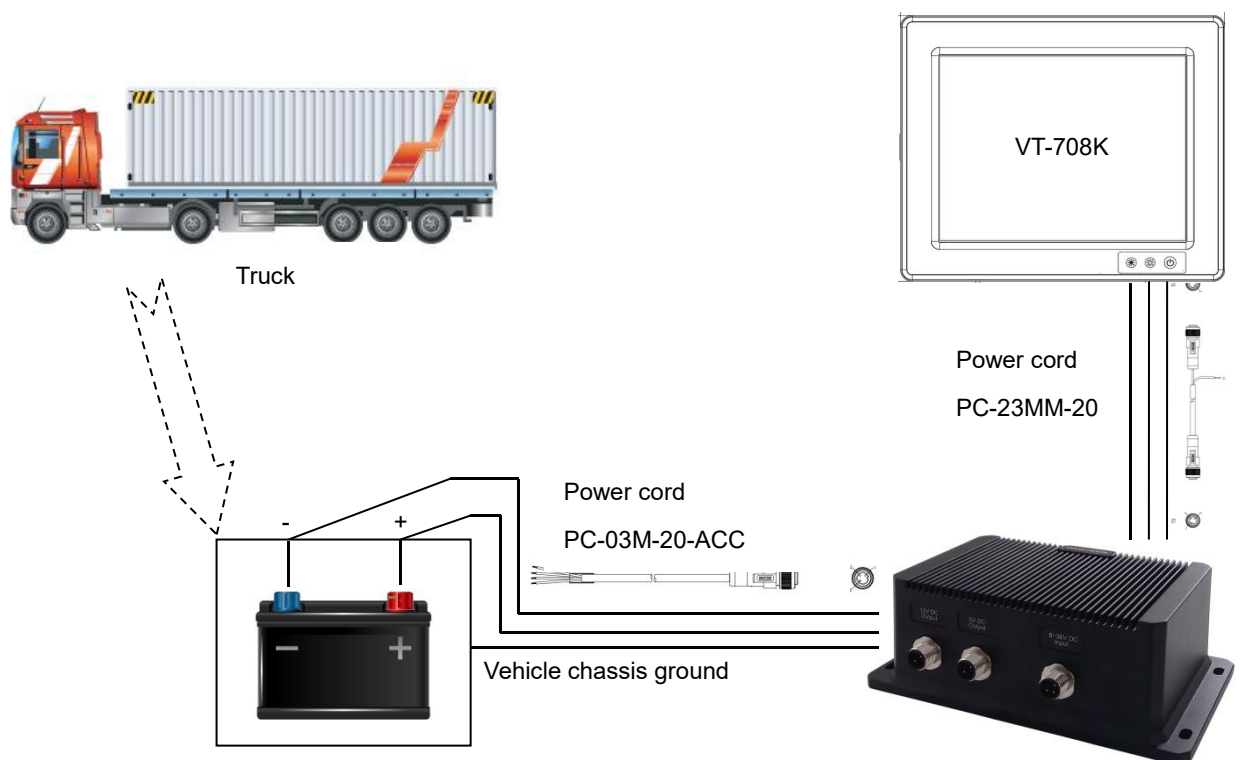

4.2.5 48 VDC Vehicles (Connected via DC/DC power)



Fuse Requirements:

WARNING - For proper and safe installation, the input power cable must be connected to a fused circuit on the vehicle. If the supply connection is made directly to the battery, the fuse should be installed in the positive lead within 5 inches of the battery's positive (+) terminal. The fused circuit requires a maximum time delay (slow blow) fuse with a current rating as noted below.

- For **48VDC** input, use a 3A slow blow fuse that has a DC voltage rating greater than 48VDC.

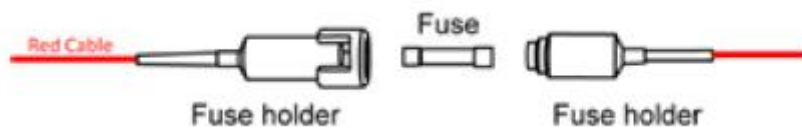

(1) Use the ignition ON/OFF function.

- c. Connect the watertight connector end of the power cable (PC-03M-20-ACC) to the PWR3672D512-M12 power connector by aligning the connector pins to the power connector, push down on the watertight connector and twist it to fasten securely.
- d. Connect the watertight connector end of the power cable (PC-23MM-20-ACC) to VT-708K and PWR3672D512-M12, then connect the yellow wire (ignition wire) to the vehicle ignition signal pin.

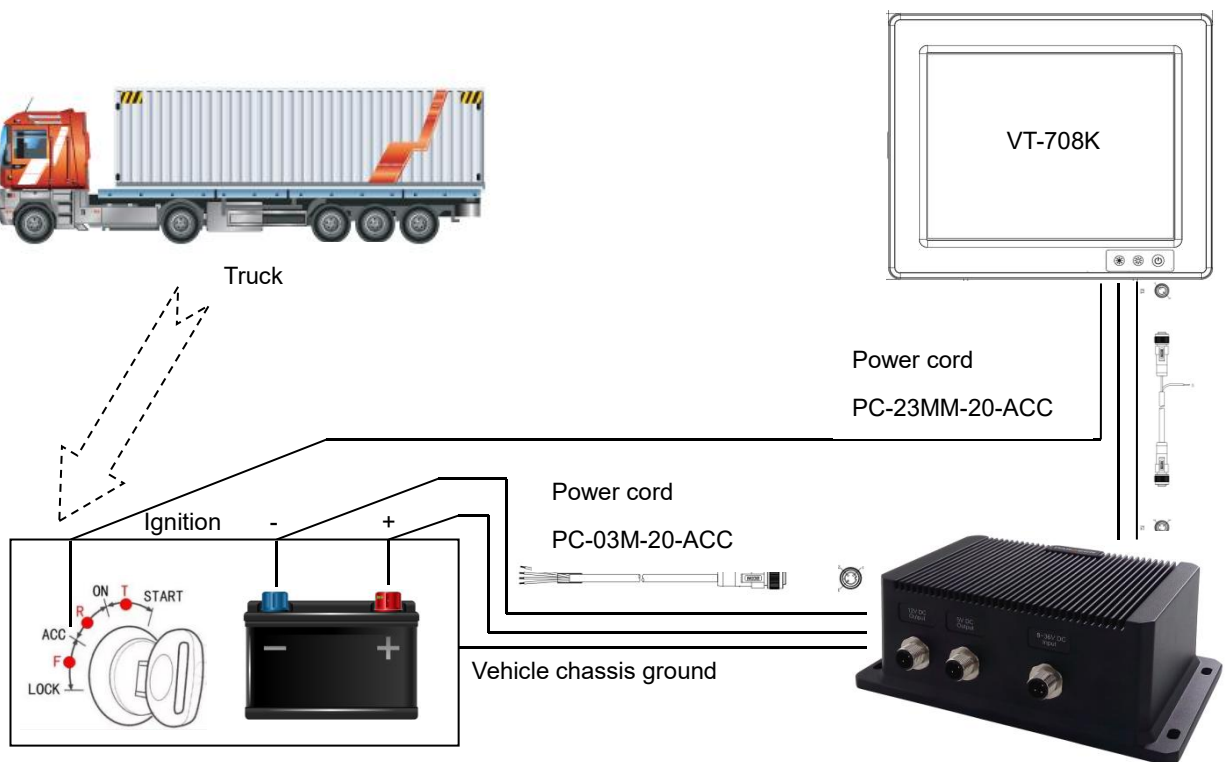

(2) Without the ignition ON/OFF function.

- d. Cut off the yellow wire (Ignition wire) on the power cord (PN: PC-03M-20-ACC);
- e. Connect the watertight connector end of the power cable (PC-03M-20-ACC) to the PWR3672D512-M12 power connector by aligning the connector pins to the power connector, push down on the watertight connector and twist it to fasten securely.
- f. Connect the watertight connector end of the power cable (PC-23MM-20) to VT-708K and PWR3672D512-M12.

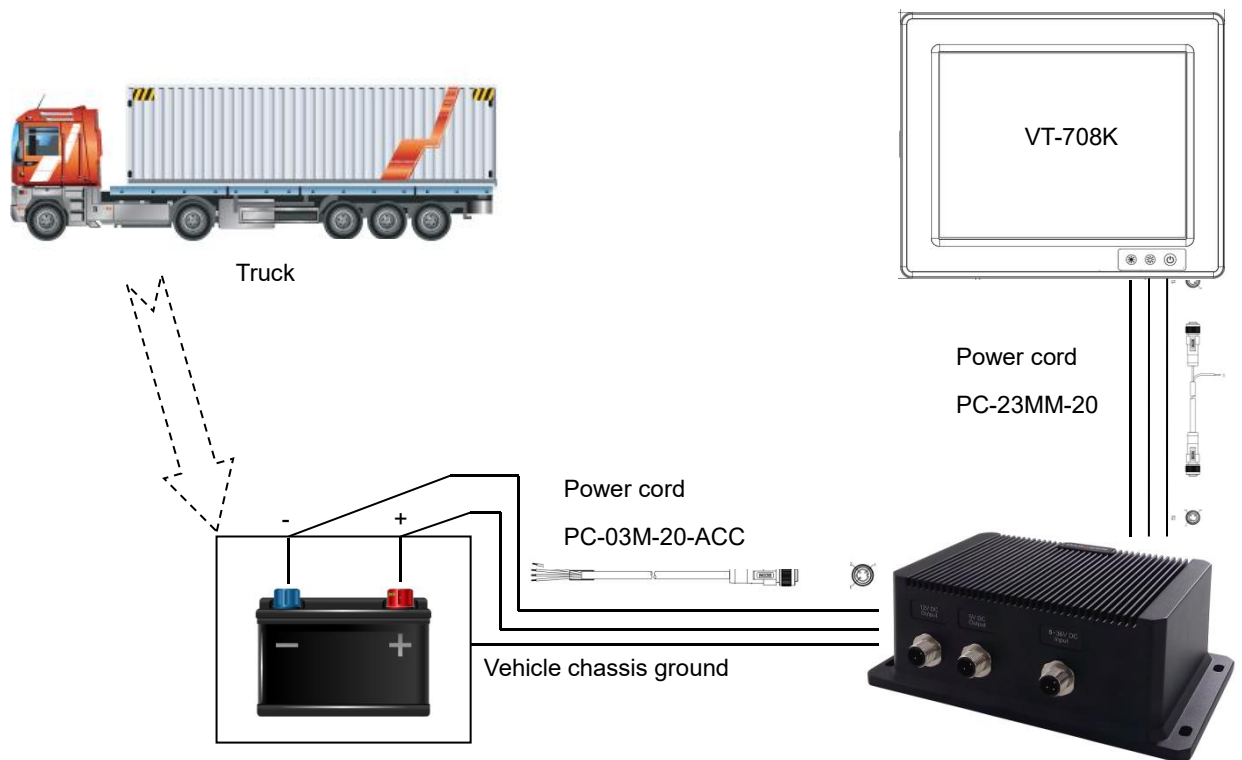

Chapter5. Installation and FAQ

5.1 Installation

VT-708K is mainly used in container terminals and yards, mining cars, logistics in manufacturing yards, warehouse management forklifts, heavy vehicles, etc. In order to adapt to its working environment, it has a variety of installation and fixing methods, including boom installation, VESA fixed installation, wall-mounted installation and so on.



5.2 Jumpers

5.2.1 Jumper list

JP5	Auto Power Button Enable/Disable Selection
JP9	COM1 Pin9 Function Selection
JP21	Clear CMOS Jumper
JP22	COM2 Pin9 Function Selection

5.2.2 Jumper Settings

(JP5) Auto Power Button Enable/Disable Selection

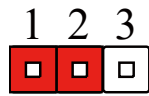

Disable Auto Power Button
(Default)

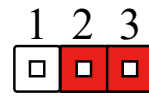

Enable Auto Power Button

(JP9) COM1 Pin9 Function Selection

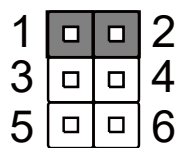

+12V

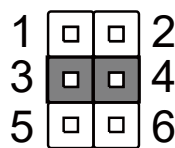

Ring (Default)

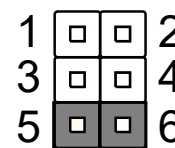

+5V

(JP21) Clear CMOS Jumper

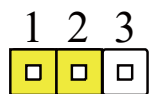

Normal (Default)

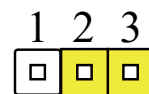

Clear CMOS

(JP22) COM2 Pin9 Function Selection

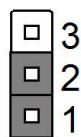

Ring (Default)

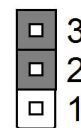

+5V

5.2.3 Jumper Description

Cards can be configured by setting jumpers. A jumper is a metal bridge used to close an electric circuit. It consists of two metal pins and a small metal clip (often protected by a plastic cover) that slides over the pins to connect them. To close a jumper, you connect the pins with the clip. To open a jumper, you remove the clip. Sometimes a jumper will have three pins, labeled 1, 2 and 3. In this case you would connect either pins 1 and 2, or 2 and 3.

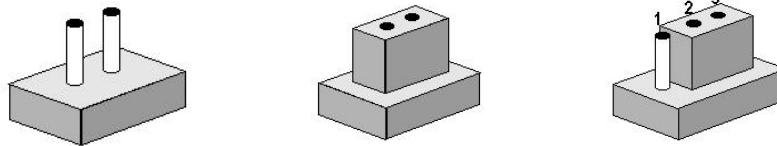

The jumper settings are schematically depicted in this manual as follows.

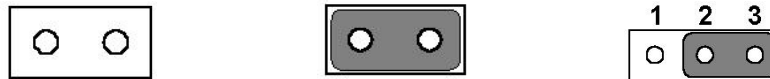

A pair of needle-nose pliers may be helpful when working with jumpers. If you have any doubts about the best hardware configuration for your application, contact your local distributor or sales representative before you make any changes. Generally, you simply need a standard cable to make most connections.

Warning! To avoid damaging the computer, always turn off the power supply before setting jumpers. Clear CMOS. Before turning on the power supply, set the jumper back to 3.0 V Battery On.



5.3 FAQ

Q1: Does the on-board terminal support ACC ignition signal delay switch?

A: VT-708K car terminal optional ACC ignition signal intelligent switch machine functions. Under the function of the ACC mode, when the on-board computer off, if the detected signal when the ACC will automatic startup latency for 10 seconds, and car terminal in the boot state, if detected the ACC will delay 10/30/120 seconds after the automatic shutdown, without artificial operation in the process of the on-board computer; When ACC is selected, the power interface of the on-board terminal will be changed to 3Pin, positive pole, negative pole, ACC detection pole. Generally, positive and negative pole are connected to vehicle batteries, and ACC detection pole is connected to ignition signal.

Q2:Why is it necessary to add a DC-DC power adapter for the installation of forklifts, trailers, front cranes and stacker?

A:The car always has a peak value at startup. In order to avoid burning out the equipment power board, the power adapter of DC-DC is needed to stabilize the voltage. The current equipment installed power board supports the voltage of 8-36V

Description:

For these battery models, there are three voltage output specifications, as follows:

- 1, trailer battery output voltage: 12V
2. Battery output voltage of front lifting and stacking machine: 24V
3. Forklift battery output voltage: 48V

Existing DC-DC power adapters are available in two specifications as follows:

- 1, 9-58 v
- 2, 18-68 v

Advice:

- 1, when the battery voltage output is 12V, 24V, choose 9-58V power adapter
- 2, when the battery voltage output is 48V, choose 18-68V power adapter.

Q3:What advantages does TNC have over SMA antenna interface?

A: TNC interface and feeder connection stability is better, not easy to loose and damage, TNC joint damage rate is low.



TNC interface

SMA interface

Q4:How to ensure the normal use of the VT-708K under the impact of high strength vibration?

A:1.VT-708K shell is made of strong aluminum alloy.

2.The VT-708K's built-in electronic modules offer excellent shock resistance, such as a gauge LCD screen and a shock-resistant solid-state drive (SSD), enabling the VT-708K to withstand harsh vibration.

5.4 Warranty and after service

Should this VT be malfunctioned, please contact your original retailer providing information about the product name, the serial number, and the details about the problem.