

QBiP-1245EB

3.5" SBC Boards

Copyright Notice

This document is copyrighted, 2025. All rights are reserved. The original manufacturer reserves the right to make improvements to the products described in this manual at any time without notice.

No part of this manual may be reproduced, copied, translated, or transmitted in any form or by any means without the prior written permission of the original manufacturer. Information provided in this manual is intended to be accurate and reliable. However, the original manufacturer assumes no responsibility for its use, or for any infringements upon the rights of third parties that may result from its use.

The material in this document is for product information only and is subject to change without notice. While reasonable efforts have been made in the preparation of this document to assure its accuracy, GIGAIPC assumes no liabilities resulting from errors or omissions in this document, or from the use of the information contained herein.

GIGAIPC reserves the right to make changes in the product design without notice to its users.

Acknowledgement

All other products' name or trademarks are properties of their respective owners.

- Microsoft Windows is a registered trademark of Microsoft Corp.
- Intel, Pentium, Celeron, and Xeon are registered trademarks of Intel Corporation
- Core, Atom are trademarks of Intel Corporation
- ITE is a trademark of Integrated Technology Express, Inc.
- IBM, PC/AT, PS/2, and VGA are trademarks of International Business Machines Corporation.

All other product names or trademarks are properties of their respective owners.

Packing List

Before setting up your product, please make sure the following items have been shipped:

Item	Quantity
QBiP-1245EB MB	1
SATA power cable	1

If any of these items are missing or damaged, please contact your distributor or sales representative immediately.

About this Document

This User's Manual contains all the essential information, such as detailed descriptions and explanations on the product's hardware and software features (if any), its specifications, dimensions, jumper/connector settings/definitions, and driver installation instructions (if any), to facilitate users in setting up their product.

Users may refer to the GIGAIPC.com for the latest version of this document.

Safety Precautions

Please read the following safety instructions carefully. It is advised that you keep this manual for future references

1. All cautions and warnings on the device should be noted.
2. Make sure the power source matches the power rating of the device.
3. Position the power cord so that people cannot step on it. Do not place anything over the power cord.
4. Always completely disconnect the power before working on the system's hardware.
5. No connections should be made when the system is powered as a sudden rush of power may damage sensitive electronic components.
6. If the device is not to be used for a long time, disconnect it from the power supply to avoid damage by transient over-voltage.
7. Always disconnect this device from any AC supply before cleaning.
8. While cleaning, use a damp cloth instead of liquid or spray detergents.
9. Make sure the device is installed near a power outlet and is easily accessible.
10. Keep this device away from humidity.
11. Place the device on a solid surface during installation to prevent falls
12. Do not cover the openings on the device to ensure optimal heat dissipation.

13. Watch out for high temperatures when the system is running.
14. Do not touch the heat sink or heat spreader when the system is running
15. Never pour any liquid into the openings. This could cause fire or electric shock.
16. As most electronic components are sensitive to static electrical charge, be sure to ground yourself to prevent static charge when installing the internal components. Use a grounding wrist strap and contain all electronic components in any static-shielded containers.
17. If any of the following situations arises, please the contact our service personnel:
 - i. Damaged power cord or plug
 - ii. Liquid intrusion to the device
 - iii. Exposure to moisture
 - iv. Device is not working as expected or in a manner as described in this manual
 - v. The device is dropped or damaged
 - vi. Any obvious signs of damage displayed on the device
- 18. DO NOT LEAVE THIS DEVICE IN AN UNCONTROLLED ENVIRONMENT WITH TEMPERATURES BEYOND THE DEVICE'S PERMITTED STORAGE TEMPERATURES (SEE CHAPTER 1) TO PREVENT DAMAGE.**

FCC Statement

Warning!



This device complies with Part 15 FCC Rules. Operation is subject to the following two conditions: (1) this device may not cause harmful interference, and (2) this device must accept any interference received including interference that may cause undesired operation.

Caution:

There is a danger of explosion if the battery is incorrectly replaced. Replace only with the same or equivalent type recommended by the manufacturer. Dispose of used batteries according to the manufacturer's instructions and your local government's recycling or disposal directives.

Attention:

Il y a un risque d'explosion si la batterie est remplacée de façon incorrecte. Ne la remplacer qu'avec le même modèle ou équivalent recommandé par le constructeur. Recycler les batteries usées en accord avec les instructions du fabricant et les directives gouvernementales de recyclage.

China RoHS Requirements (CN)

产品中有毒有害物质或元素名称及含量

GIGAIPC Main Board/ Daughter Board/ Backplane

部件名称	有毒有害物质或元素					
	铅 (Pb)	汞 (Hg)	镉 (Cd)	六价铬 (Cr(VI))	多溴联苯 (PBB)	多溴二苯醚 (PBDE)
印刷电路板 及其电 子组件	○	○	○	○	○	○
外部信号 连接器 及线材	○	○	○	○	○	○

○: 表示该有毒有害物质在该部件所有均质材料中的含量均在 SJ/T 11363-2006 标准规定的限量要求以下。
 X: 表示该有毒有害物质至少在该部件的某一均质材料中的含量超出 SJ/T 11363-2006 标准规定的限量要求。
 备注: 此产品所标示之环保使用期限, 系指在一般正常使用状况下。

China RoHS Requirement (EN)

Poisonous or Hazardous Substances or Elements in Products GIGAIPC Main Board/ Daughter Board/ Backplane

Component	Poisonous or Hazardous Substances or Elements					
	Lead (Pb)	Mercury (Hg)	Cadmium (Cd)	Hexavalent Chromium (Cr(VI))	Polybrominated Biphenyls (PBB)	Polybrominated Diphenyl Ethers (PBDE)
PCB & Other Components	○	○	○	○	○	○
Wires & Connectors for External Connections	○	○	○	○	○	○
<p>○ : The quantity of poisonous or hazardous substances or elements found in each of the component's parts is below the SJ/T 11363-2006-stipulated requirement.</p> <p>X: The quantity of poisonous or hazardous substances or elements found in at least one of the component's parts is beyond the SJ/T 11363-2006-stipulated requirement.</p> <p>Note: The Environment Friendly Use Period as labeled on this product is applicable under normal usage only</p>						

Table Contents

3.5" SBC Boards	1
Copyright Notice	2
Acknowledgement	3
Packing List	4
About this Document	5
Safety Precautions	6
FCC Statement.....	8
China RoHS Requirements (CN).....	9
China RoHS Requirement (EN)	10
Chapter 1 - Product Specifications	14
1.1 Specifications	16
Chapter 2 – Hardware Information	18
2.1 Jumpers and Connectors	19
2.2.1 CPU_FAN (CPU fan connector)	22
2.2.2 SYS_FAN (System fan connector)	23
2.2.3 COM1 (Serial Port (RS-232/422/485 & RI/5V/12V))	24
2.2.4 LAN2 (LAN connector).....	25
2.2.5 LAN1 (LAN connector).....	26
2.2.6 HDMI2_21 (HDMI connector).....	27
2.2.7 USB32_2 (USB 3.2 Gen 2x1 connector).....	28
2.2.8 USB32_1 (USB 3.2 Gen 2x1 connector).....	29
2.2.9 SODIMM1, SODIMM2 (DDR4 SO-DIMM Slot).....	30
2.2.10 LSW (LVDS resolution jumper)	31

2.2.11	LVDS (LVDS connector).....	32
2.2.12	BKL_CN (Backlight control header).....	33
2.2.13	SPK_OUT (Speaker out connector).....	34
2.2.14	FP_AUDIO (Front Audio connector).....	35
2.2.15	GPIO_CNT (General Purpose input/output header).....	36
2.2.16	SYS_PANEL (Front panel header).....	37
2.2.17	DC_IN (DC IN 1x4 pin power connector).....	38
2.2.18	AT_CN (AT/ATX mode select jumper).....	39
2.2.19	COM2, COM3, COM4 (Serial port header, RS-232/422 /485).....	40
2.2.20	FUSB1, FUSB2 (USB 2.0 headers).....	41
2.2.21	ME_DIS (ME Disable jumper).....	42
2.2.22	JCOM1 (RI# pin RI#/5V/12V Select jumper for COM1 Port).....	43
2.2.23	SATA0 (SATA 6Gb/s connector).....	44
2.2.24	SATAPWR (SATA power connector).....	45
2.2.25	M2E (M.2 Slot, 2230 E-key).....	46
2.2.26	MPCIE (Mini PCIe slot).....	47
2.2.27	BATTERY (Battery cable Connector).....	48
2.2.28	M2M_CPU (M.2 Slot, 2280 M-key).....	49

Chapter 3 – BIOS 50

3.1	Introduction.....	51
3.2	The Main Menu.....	52
3.3	Advanced.....	53
3.3.1	TPM Configuration.....	54

3.3.2	CPU Configuration	56
3.3.3	SATA Configuration	57
3.3.4	IT8786 Super IO Configuration	58
3.3.5	Hardware Monitor	59
3.3.6	S5 RTC Wake Settings	60
3.3.7	Network Stack Configuration.....	61
3.3.8	NVMe Configuration	62
3.3.9	Offboard SATA Controller Configuration	63
3.3.10	Digital IO Port Configuration	64
3.3.11	Tls Auth Configuration	65
3.3.12	Intel(R) Ethernet Controller I226-V - 74:56:3C:B4:42:94 (MAC address may varied based on different motherboard)	66
3.3.13	Intel(R) Ethernet Controller I226-V - 74:56:3C:B4:42:95 (MAC address may varied based on different motherboard)	67
3.4	Chipset	68
3.5	Security	70
3.6	Boot.....	73
3.7	Save & Exit	74

Chapter 1

Chapter 1 - Product Specifications

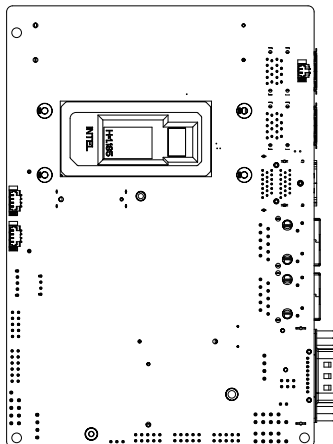
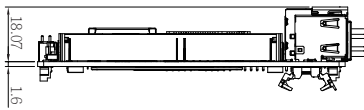
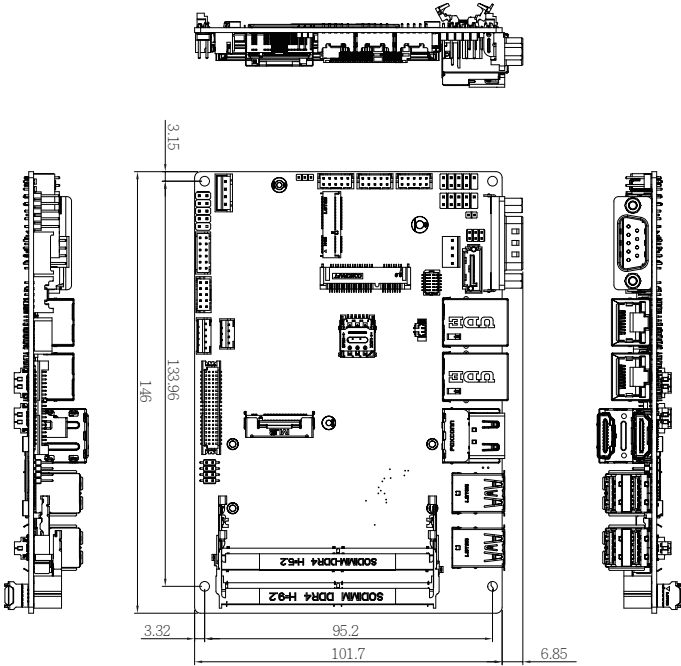

1.1 Specifications

Motherboard	QBiP-1245EB
Form Factor	3.5" SBC 146W x 101.7Dmm
CPU	Intel® Core™ i5-1245UE Processor Intel® 7, 10 cores, 2P+8E, 12 threads, up to 4.4 GHz TDP 15W 12 MB Smart Cache
Socket	1 x FCBGA1744
Memory	2 x DDR4 SO-DIMM sockets, Max. Capacity 64 GB Support Dual channel DDR4 3200 MHz memory modules
Ethernet	2 x 2.5GbE LAN Ports (Intel® I226V & I226LM)
Video	Integrated Graphics Processor - Intel® Iris® Xe Graphics eligible: 2 x HDMI 2.0 port, supporting a maximum resolution of 4096x2160 @60Hz 1 x LVDS port, supporting a maximum resolution of 1920x1200 @60Hz (3 independent display outputs)
Audio	Realtek® ALC269
Storage	1 x SATA 6Gb/s port
Raid	Intel® SATA RAID 0/1
Expansion Slots	1 x 2280 M.2 M-Key (PCIe Gen4x4, SATA 6Gb/s) 1 x 2230 M.2 E-Key 1 x Full-size Mini PCIe with SIM slot
Internal I/O	1 x 4-pin box power connector (DC in +9V~36VDC) 1 x SATA Power header 1 x CPU fan header 1 x System fan header 1 x Front panel header 1 x Front panel audio header 1 x 2W Speaker out header 4 x USB 2.0 headers 3 x COM headers (RS-232/422/485) 1 x Backlight control header 1 x AT/ATX mode select jumper 1 x GPIO (8-bits) & SMBus header

Motherboard	QBiP-1245EB
Rear I/O	1 x COM Port (RS-232/422/485 & RI/5V/12V) 2 x HDMI 2 x RJ45 LAN Ports 4 x USB 3.2 Gen 2x1
TPM	Onboard TPM 2.0 security chip INFINEON SLB9672VU2.0
OS Compatibility	Windows® 10/11 (x64)
Operating Properties	Operating temperature: 0°C to 60°C Operating humidity: 0-90% (non-condensing) Non-operating temperature: -40°C to 85°C Non-operating humidity: 0%-95% (non-condensing)

Chapter 2

Chapter 2 – Hardware Information

2.1 Jumpers and Connectors

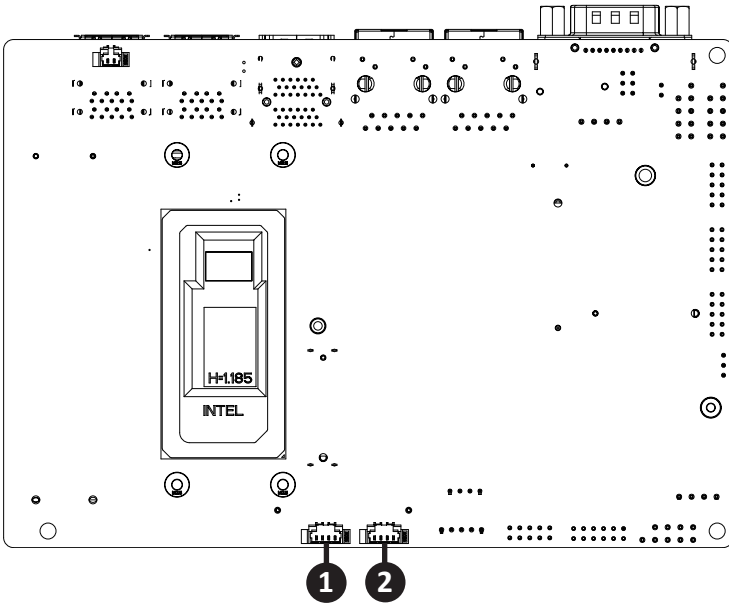
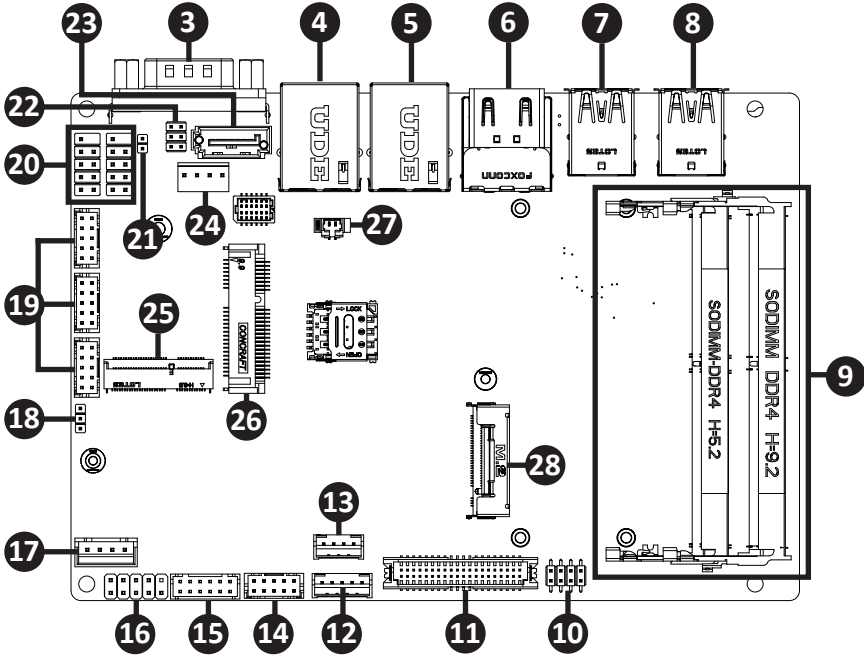

No	Code	Description
1	CPU_FAN	CPU fan connector
2	SYS_FAN	System fan connector
3	COM1	Serial Port (RS-232/422/485 & RI/5V/12V)
4	LAN2	LAN connector
5	LAN1	LAN connector
6	HDMI2_21	HDMI connector
7	USB32_2	USB 3.2 Gen 2x1 connector
8	USB32_1	USB 3.2 Gen 2x1 connector
9	SODIMM1 SODIMM2	DDR4 SO-DIMM Slot
10	LSW	LVDS resolution jumper
11	LVDS	LVDS connector
12	BKL_CN	Backlight control header
13	SPK_OUT	Speaker out connector
14	FP_AUDIO	Front Audio connector
15	GPIO_CNT	General purpose input / ouput header
16	SYS_PANEL	Front panel header
17	DC_IN	DC IN 1x4 pin power connector
18	AT_CN	AT/ATX mode select jumper
19	COM2, COM3, COM4	Serial port header (RS-232/422/485)
20	FUSB1, FUSB2	USB 2.0 headers
21	ME_DIS	ME Disable jumper

No	Code	Description
22	JCOM1	RI# pin RI#/5V/12V Select jumper for COM1 Port
23	SATA0	SATA 6Gb/s connector
24	SATAPWR	SATA power connector
25	M2E	M.2 Slot, 2230 E-key
26	MPCIE	Mini PCIe slot
27	BATTERY	Battery cable connector
28	M2M_CPU	M.2 Slot, 2280 M-key

2.2.1 CPU_FAN (CPU fan connector)

1

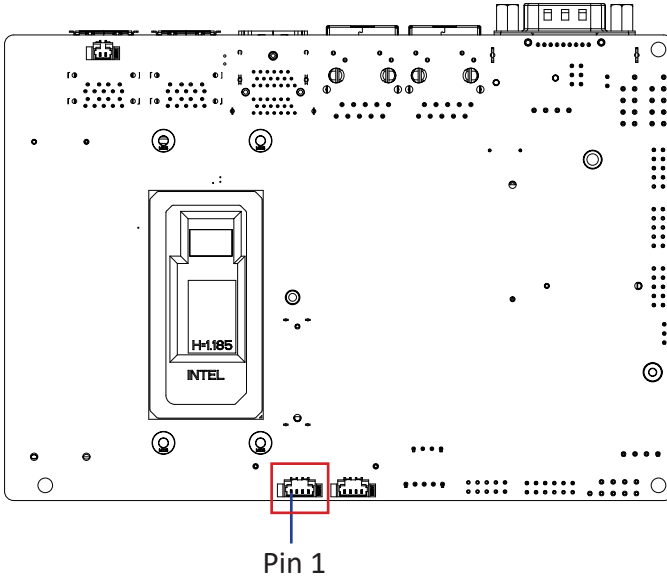

CPU fan Connector



Pin No.	Definition
1	GND
2	12V
3	Detect
4	Speed control

Connector PN

85205-0470N

A1250WV-S-04PC

Vendor

ACES

JOINT-TECH

Connector type

1x4pin header, pitch 1.25mm

2.2.2 SYS_FAN (System fan connector)

2

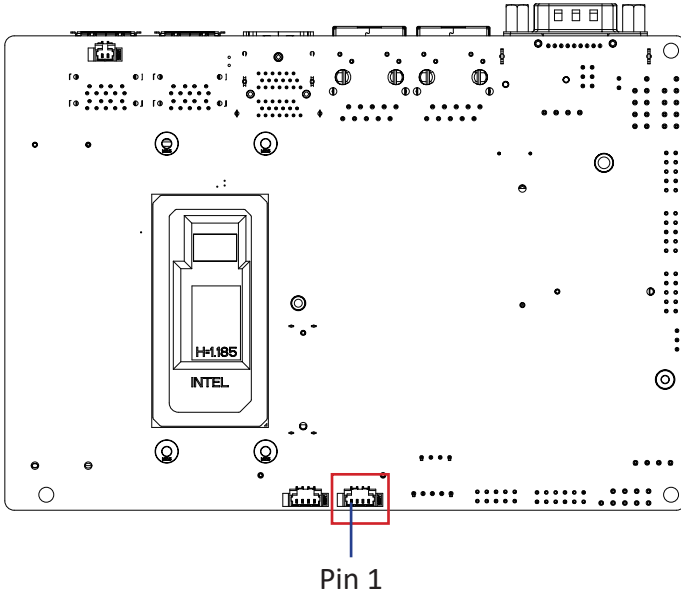

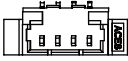
System fan Connector	
	
1 2 3 4	
Pin No.	Definition
1	GND
2	12V
3	Detect
4	Speed control

Connector PN	Vendor
85205-0470N	ACES
A1250WV-S-04PC	JOINT-TECH
Connector type	
1x4pin header, pitch 1.25mm	

2.2.3 COM1 (Serial Port (RS-232/422/485 & RI/5V/12V))

3

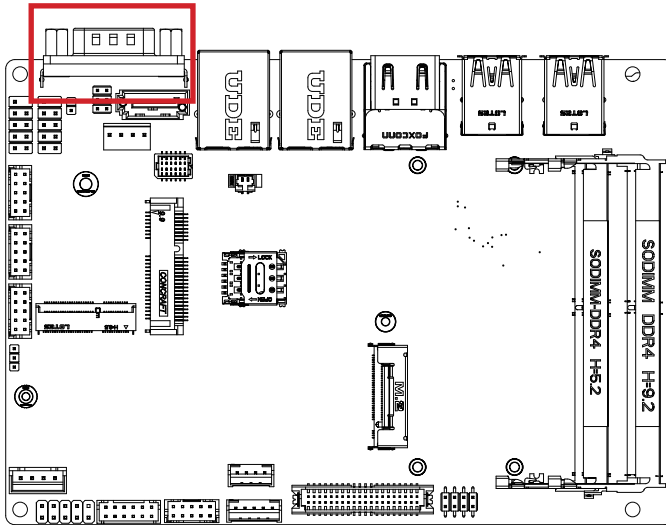

Serial Port connector

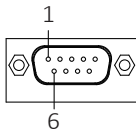

Connector PN

SM41D1P1122N33N1

Vendor

FENYING

Pin No.	RS-232	RS-422 Full Duplex	RS-485 Half Duplex
1	DCD	TXD-	D-
2	RXD	TXD+	D+
3	TXD	RXD+	-
4	DTR	RXD-	-
5	GND		
6	DSR	-	-
7	RTS	-	-
8	CTS	-	-
9	RI	-	-

2.2.4 LAN2 (LAN connector)

4

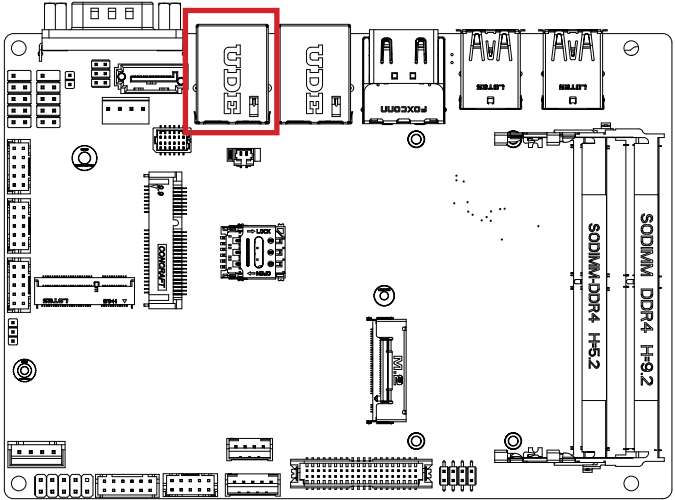

LAN Connector

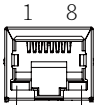

Link / Activity LED Connection/Speed LED

Pin No.	Definition
1	BI_DA+
2	BI_DA-
3	BI_DB+
4	BI_DC+
5	BI_DC-
6	BI_DB-
7	BI_DD+
8	BI_DD-

State	Description
Yellow On	2.5Gbps data rate
Green On	1Gbps data rate
Off	100Mbps data rate
Off	10Mbps data rate

Connector PN	Vendor
RB1-GB-0009	UDE

2.2.5 LAN1 (LAN connector)

5

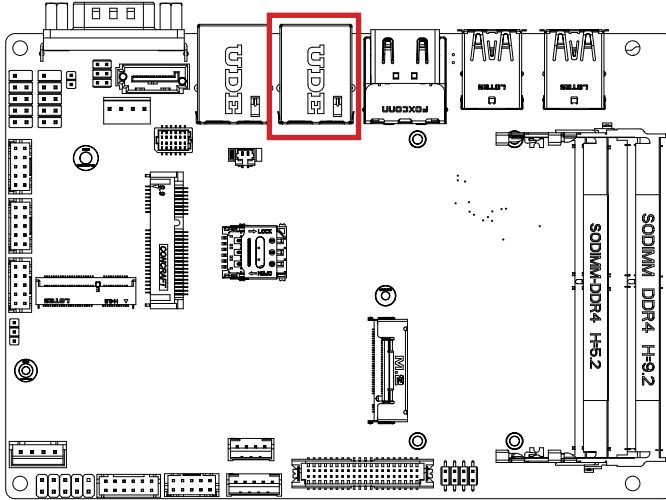

LAN Connector

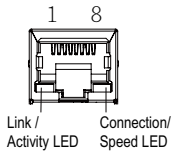

Pin No.	Definition
1	BI_DA+
2	BI_DA-
3	BI_DB+
4	BI_DC+
5	BI_DC-
6	BI_DB-
7	BI_DD+
8	BI_DD-

State	Description
Yellow On	2.5Gbps data rate
Green On	1Gbps data rate
Off	100Mbps data rate
Off	10Mbps data rate

Connector PN	Vendor
RB1-GB-0009	UDE

2.2.6 HDMI2_21 (HDMI connector)

6

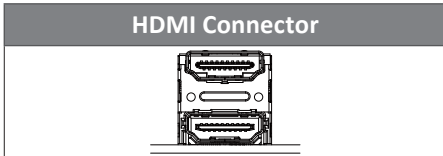
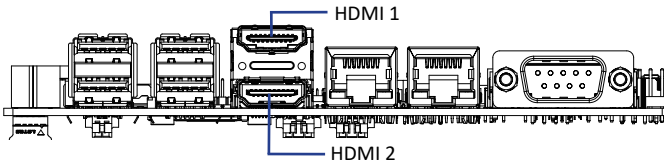
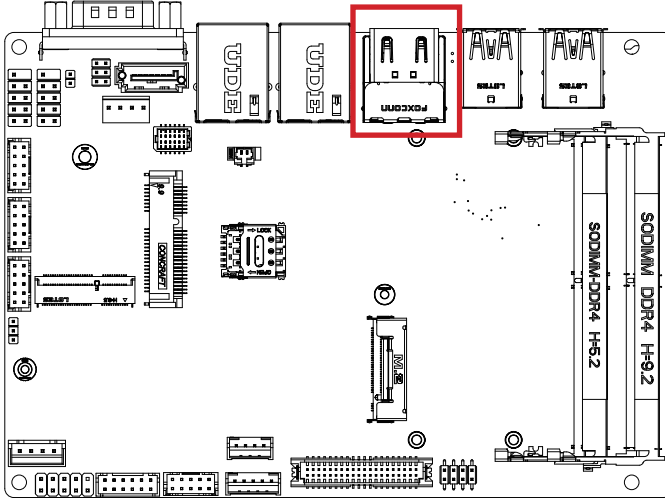

Connector PN	Vendor
QJ11191-DFB1-4F	FOXCONN

Pin No.	Definition	Pin No.	Definition
1	HDMI_D2p	11	GND
2	GND	12	HDMI_CLKn
3	HDMI_D2n	13	NC
4	HDMI_D1p	14	NC
5	GND	15	HDMI_SCL
6	HDMI_D1n	16	HDMI_SDA
7	HDMI_D0p	17	GND
8	GND	18	5V
9	HDMI_D0n	19	HDMI_HPD
10	HDMI_CLKp		

2.2.7 USB32_2 (USB 3.2 Gen 2x1 connector)

7

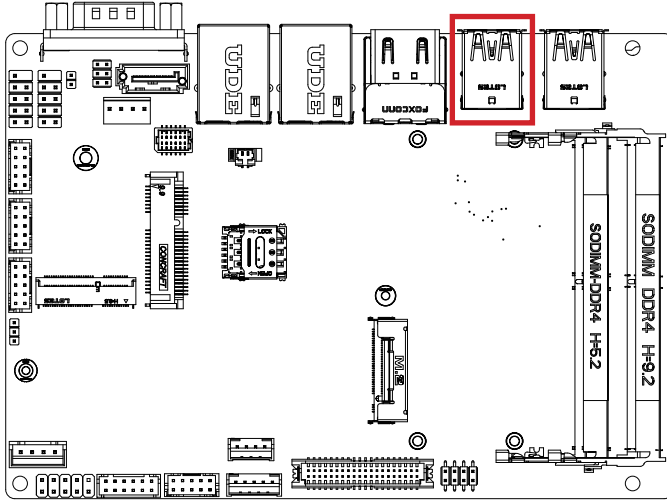

USB Connector



Connector PN

18-A5950-6A33-A

Vendor

TCONN

Pin No.	Definition	Pin No.	Definition
1	5V	10	5V
2	USB_Dn	11	USB_Dn
3	USB_Dp	12	USB_Dp
4	GND	13	GND
5	USB3_RXn	14	USB3_RXn
6	USB3_RXp	15	USB3_RXp
7	GND	16	GND
8	USB3_TXn	17	USB3_TXn
9	USB3_TXp	18	USB3_TXp

2.2.8 USB32_1 (USB 3.2 Gen 2x1 connector)

8

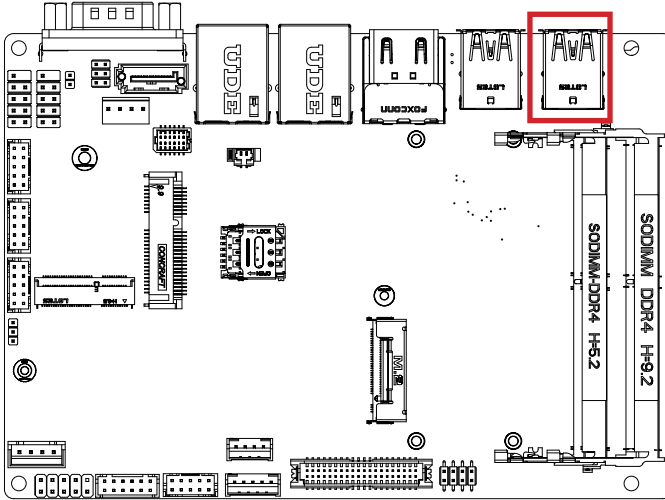

USB Connector



Connector PN

18-A5950-6A33-A

Vendor

TCONN

Pin No.	Definition	Pin No.	Definition
1	5V	10	5V
2	USB_Dn	11	USB_Dn
3	USB_Dp	12	USB_Dp
4	GND	13	GND
5	USB3_RXn	14	USB3_RXn
6	USB3_RXp	15	USB3_RXp
7	GND	16	GND
8	USB3_TXn	17	USB3_TXn
9	USB3_TXp	18	USB3_TXp

2.2.9 SODIMM1, SODIMM2 (DDR4 SO-DIMM Slot)

9

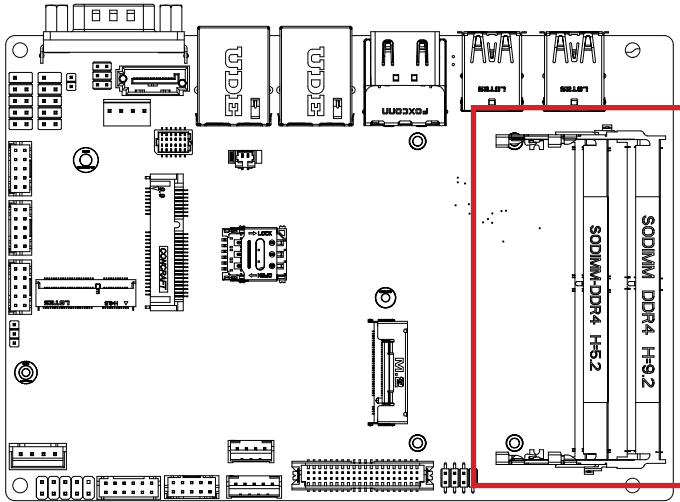

2.2.10 LSW (LVDS resolution jumper)

10

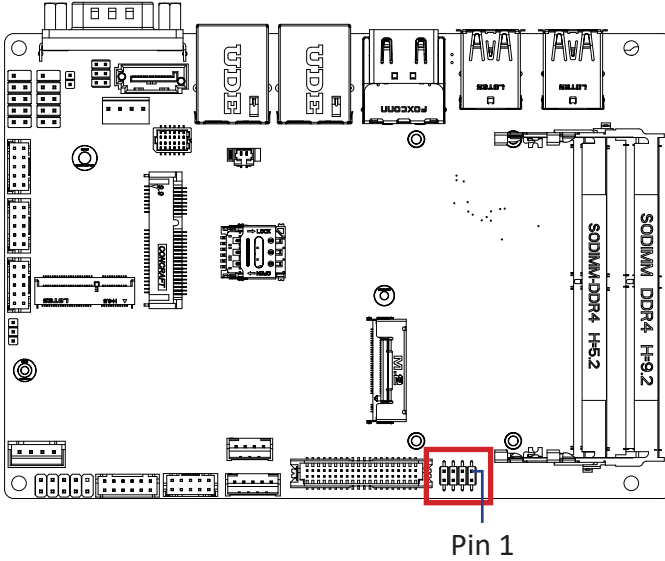

LVDS Resolution Jumper			
Jumper Setting	Resolution	Jumper Setting	Resolution
	800 x 600 18bit		1366 x 768 24bit
	1024 x 768 18bit		1440 x 900 24bit
	1024 x 768 24bit		1400 x 1050 24bit
	1024 x 600 18bit		1600 x 900 24bit
	1280 x 800 18bit		1680 x 1050 24bit
	1280 x 960 18bit		1600 x 1200 24bit
	1280 x 1024 24bit		1920 x 1080 24bit
	1366 x 768 18bit		1920 x 1200 24bit

Connector PN	Vendor
222-97-04GBE1	PINREX
Connector type	
2x4pin header, pitch 2.0mm	

2.2.11 LVDS (LVDS connector)

11

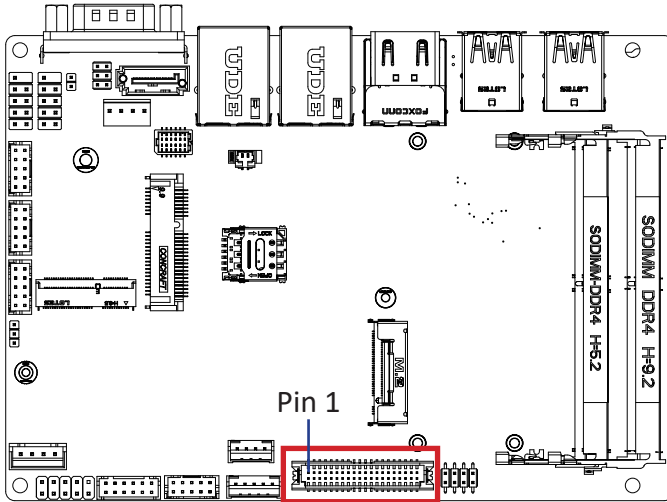

LVDS Connector



Pin No.	Definition	Pin No.	Definition
1	3.3V	21	A5+
2	5V	22	A4+
3	3.3V	23	A5-
4	5V	24	A4-
5	SPECO	25	GND
6	SPEDO	26	GND
7	GND	27	A7+
8	GND	28	A6+
9	A1+	29	A7-
10	A0+	30	A6-
11	A1-	31	GND
12	A0-	32	GND
13	GND	33	CLK2+
14	GND	34	CLK1+
15	A3+	35	CLK2-
16	A2+	36	CLK1-
17	A3-	37	GND

Pin No.	Definition	Pin No.	Definition
18	A2-	38	GND
19	GND	39	12V
20	GND	40	12V

Connector PN	Vendor
712-76-40GWEO	PINREX
A1252WV-SF-2X20PD01	JOINT-TECH

Connector type
2x20pin header, pitch 1.25mm

For each model support LVDS function.
But below model no need to add.
A0~A3 is odd channel 0~3, A4~A7 is even channel.

Note: *The LVDS output connector of the unit is only intended to be connected to an UL/IEC/EN approval equipment with fire enclosure.

2.2.12 BKL_CN (Backlight control header)

12

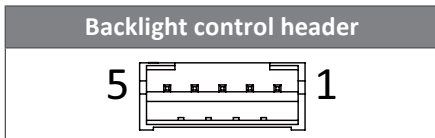
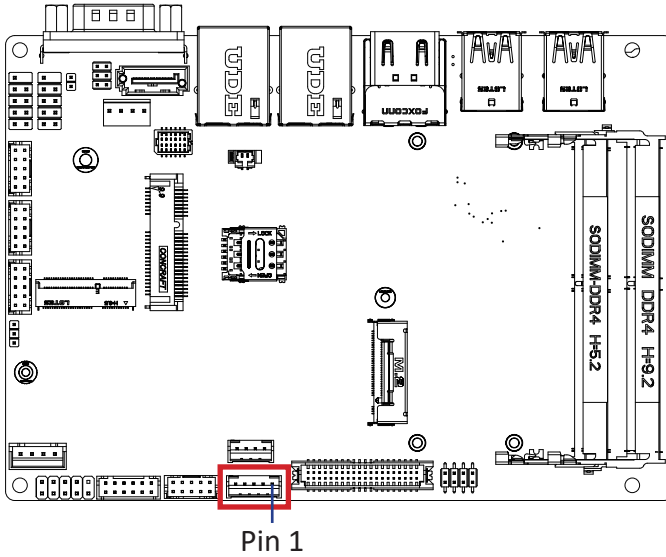

Pin No.	Definition
1	5V
2	PWM
3	Backlight Enable
4	GND
5	12V

Connector PN	Vendor
721-81-05TW00	PINREX
A2001WV-05P146	JOINT-TECH

Connector type
1x5pin header, pitch 2.0mm

2.2.13 SPK_OUT (Speaker out connector)

13

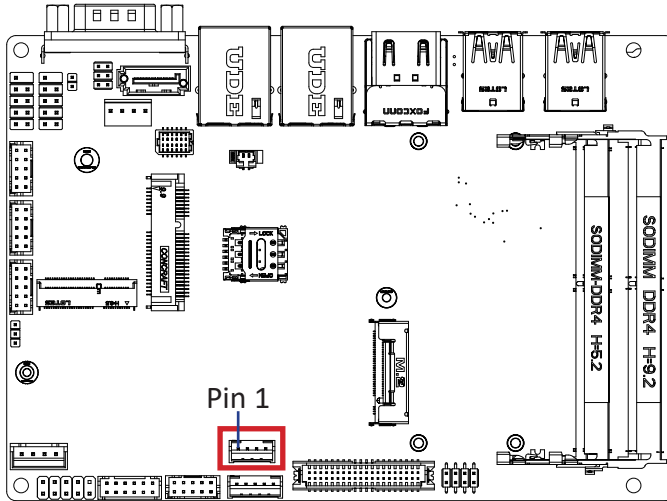

Audio Amplifier Connector

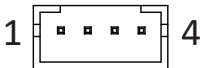

Pin No.	Definition
1	Speaker Out L+
2	Speaker Out L-
3	Speaker Out R-
4	Speaker Out R+

Connector PN

721-81-045W00

A2001WV-04P146

Vendor

PINREX

JOINT-TECH

Connector type

1x4pin header, pitch 2.0mm

2.2.14 FP_AUDIO (Front Audio connector)

14

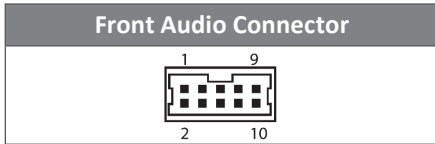
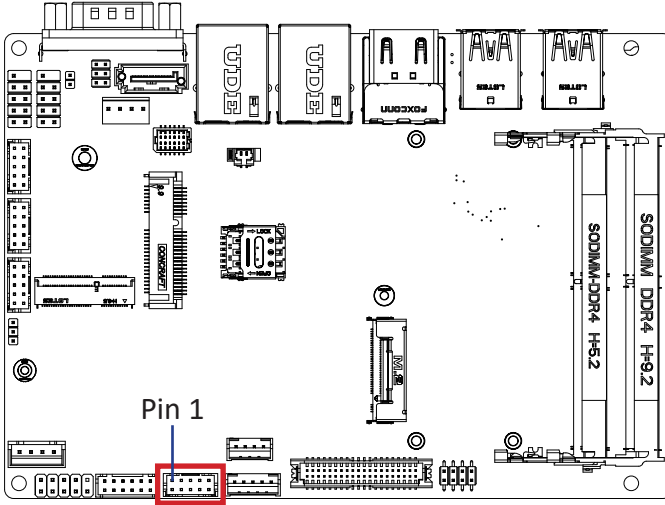

Pin No.	Definition
1	MIC_Left
2	GND
3	MIC_Right
4	NC
5	LINE_Right
6	MIC_JD
7	Jacksense Detect
8	No Connect
9	LINE_Left
10	GND

Connector PN	Vendor
725-81-10TW00	PINREX
A2004WV-2X05P46	JOINT-TECH

Connector type
2x5pin header, pitch 2.0mm

2.2.15 GPIO_CNT (General Purpose input/output header)

15

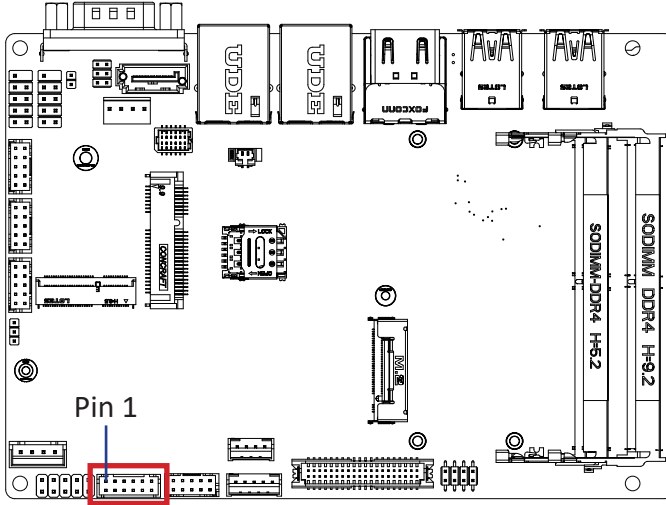

GPIO Connector

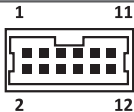

Pin No.	Definition
10	SMB_DATA
11	5V
12	GND

Pin No.	Definition
1	GPIO-output_1
2	GPIO-input_1
3	GPIO-output_2
4	GPIO-input_2
5	GPIO-output_3
6	GPIO-input_3
7	GPIO-output_4
8	GPIO-input_4
9	SMBus Clock

Connector PN	Vendor
725-81-12TW00	PINREX
A2004WV-2X06P46	JOINT-TECH

Connector type
2x6pin header, pitch 2.0mm

2.2.16 SYS_PANEL (Front panel header)

16

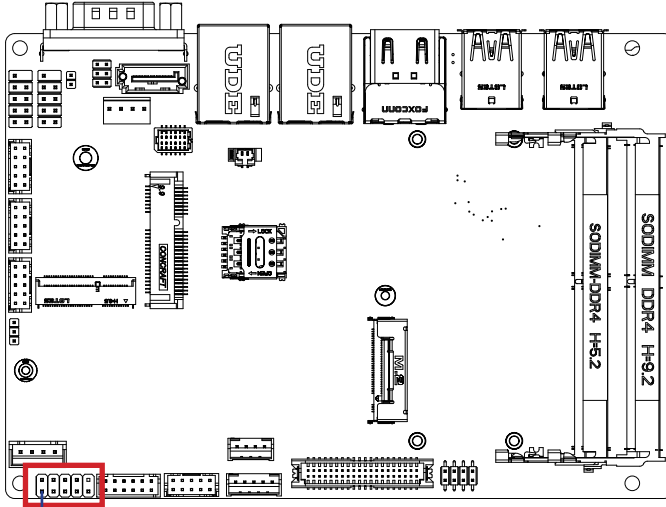

Pin 1

System Panel Header	
2	10
1	9

Pin No.	Definition
1	HDD LED+
2	Power LED+
3	HDD LED-
4	Power LED-
5	GND
6	Power Button+
7	Reset Button
8	Power Button-
9	No Connect
10	No Pin

Connector PN	Vendor
210-92-05GW5W	PINREX

Connector type
2x5pin header, pitch 2.54mm

2.2.17 DC_IN (DC IN 1x4 pin power connector)

17

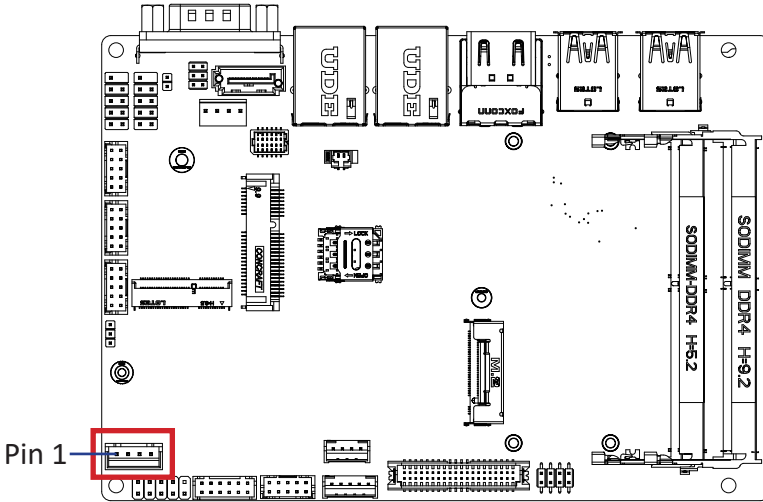

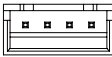
DC IN connector	
 1 2 3 4	
Pin No.	Definition
1	GND
2	Power
3	Power
4	GND

Connector PN	Vendor
753-81-04TW00	PINREX
Connector type	
1x4pin header, pitch 2.5mm	

2.2.18 AT_CN (AT/ATX mode select jumper)

18

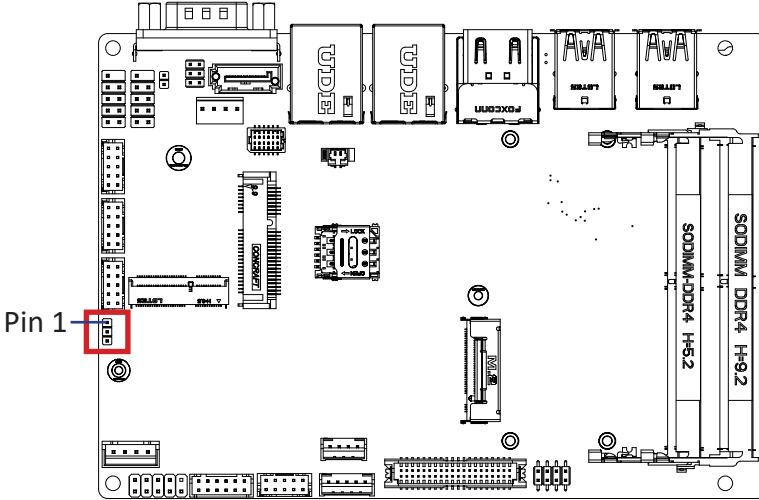

AT/ATX mode select jumper	

Connector PN	Vendor
220-96-03GB001K	PINREX

Connector type
1x3pin header, pitch 2.0mm

Pin No.	Definition
1	AT MODE
2	TXD5
3	ATX MODE

Jumper setting
 1-2 Close : AT mode.
 2-3 Close : ATX mode.(Default setting)

2.2.19 COM2, COM3, COM4 (Serial port header, RS-232/422/485)

19

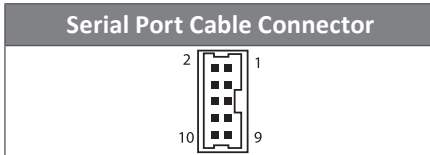
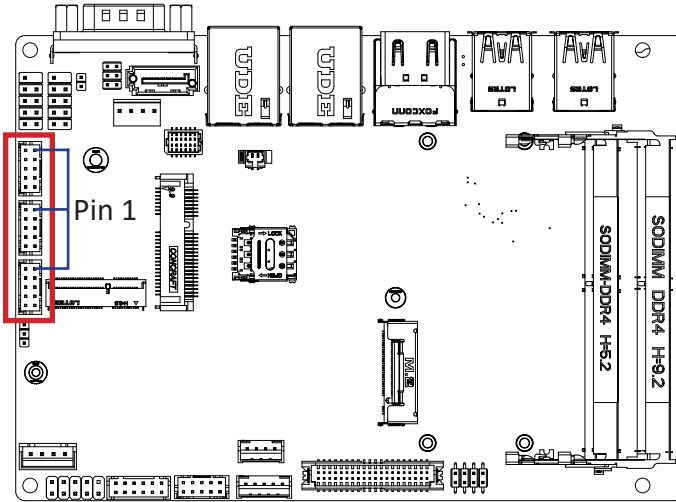

Pin No.	RS-232	RS-422 Full Duplex	RS-485 Half Duplex
1	RXD	TXD+	D+
2	DCD	TXD-	D-
3	DTR	RXD-	—
4	TXD	RXD+	—
5	DSR	—	—
6	GND	—	—
7	CTS	—	—
8	RTS	—	—
9	No Connect	—	—
10	RI	—	—

Connector PN	Vendor
725-81-10TW00	PINREX
A2004WV-2X05P46	JOINT-TECH

Connector type
2x5pin header, pitch 2.0mm

2.2.20 FUSB1, FUSB2 (USB 2.0 headers)

20

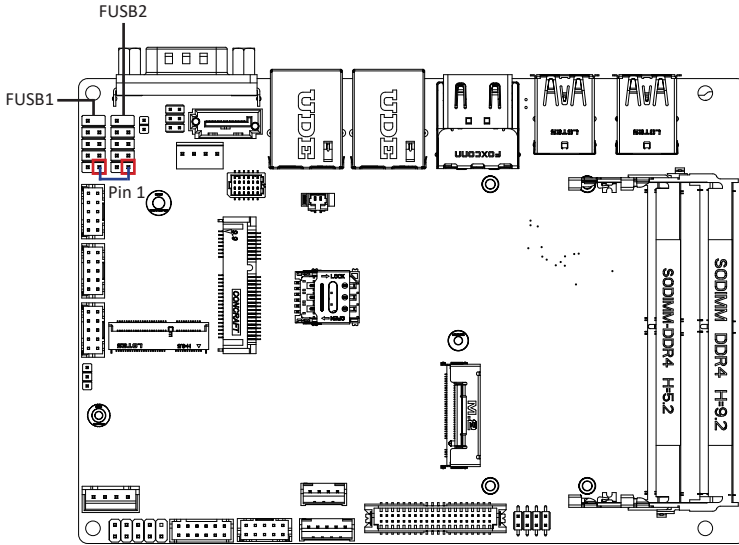

USB 2.0 Header



Connector PN

210-92-05GB04

PH10R53BAZ009

Vendor

PINREX

HORNGTONG

Connector type

2x5pin header, pitch 2.54mm

Pin No.	Definition
1	5V
2	5V
3	DXn
4	DYn
5	DXp
6	DYp
7	GND
8	GND
9	No Pin
10	No Connect

2.2.21 ME_DIS (ME Disable jumper)

21

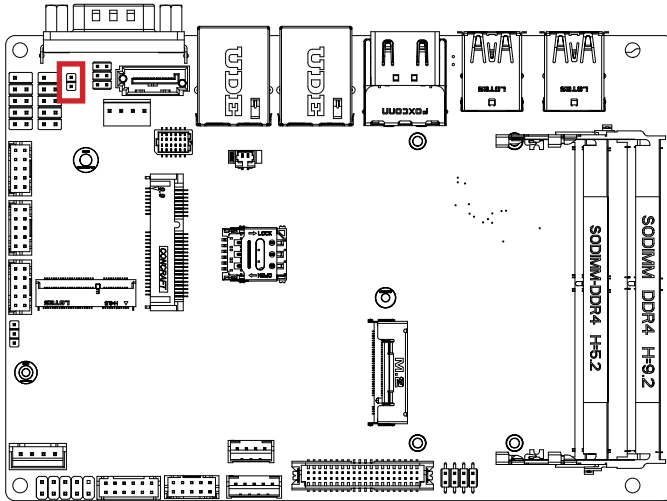

ME Disable Connector



ME Disable jumper



Enable (Default setting)



Disable

Connector PN

220-96-02GBK1

Vendor

PINREX

Connector type

1x2pin header, pitch 2.0mm

2.2.22 JCOM1 (RI# pin RI#/5V/12V Select jumper for COM1 Port)

5

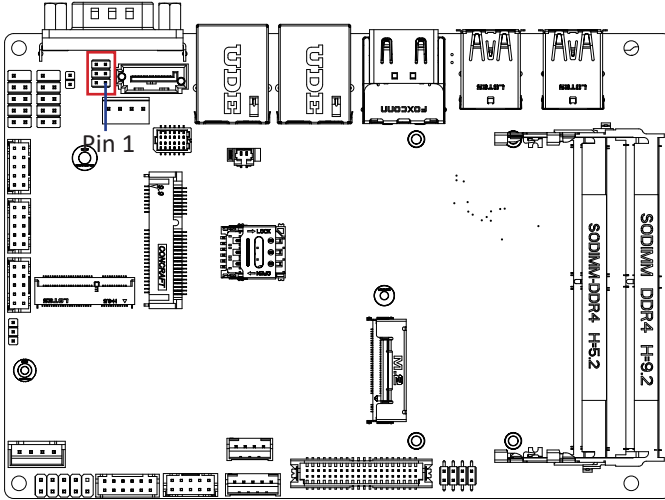

JCOM1 Jumper Select	
<p>6 5 2 1</p>	1-2 Close: 5V (Power COM)
<p>6 5 2 1</p>	3-4 Close: RI (Stand COM) (Default-Setting)
<p>6 5 2 1</p>	5-6 Close: 12V (Power COM)

Connector PN	Vendor
220-97-03GB01	PINREX
PH06N53BAZ000	HORNGTONG
Connector type	
2x3pin header, pitch 2.0mm	

2.2.23 SATA0 (SATA 6Gb/s connector)

23

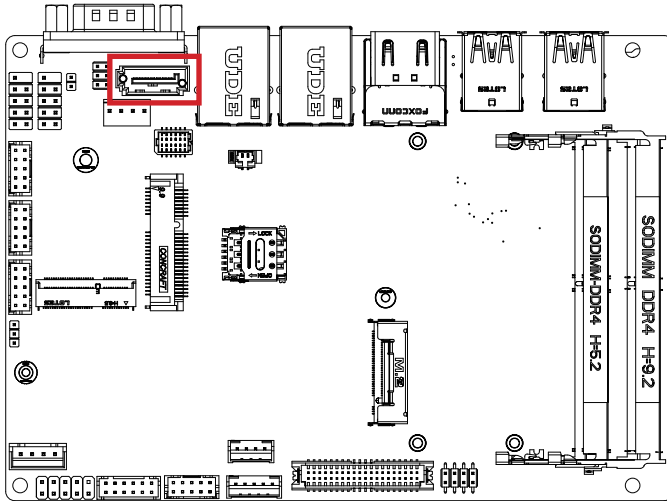

SATA Connector



Connector PN

WATF-07DBLBA1UW

Vendor

WINWIN

Pin No.	Definition
1	GND
2	TXp
3	TXn
4	GND
5	RXn
6	RXp
7	GND

2.2.24 SATAPWR (SATA power connector)

24

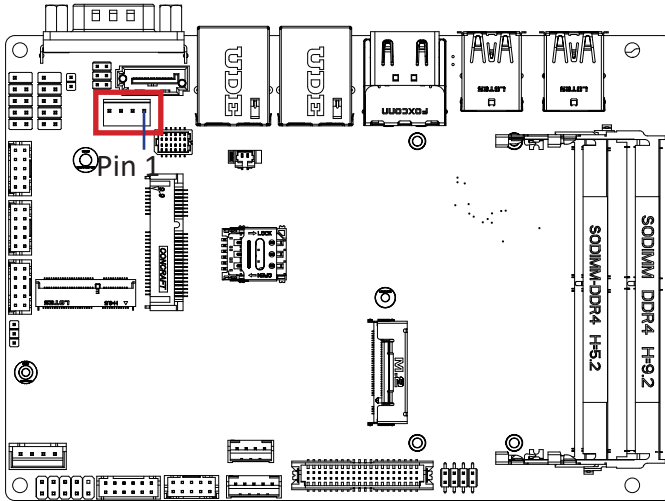

Hard Disk Power Connector	
4  1	
Pin No.	Definition
1	12V
2	GND
3	GND
4	5V

Connector PN	Vendor
743-81-04TW00	PINREX
Connector type	
1x4pin header, pitch 2.54mm	

2.2.25 M2E (M.2 Slot, 2230 E-key)

25

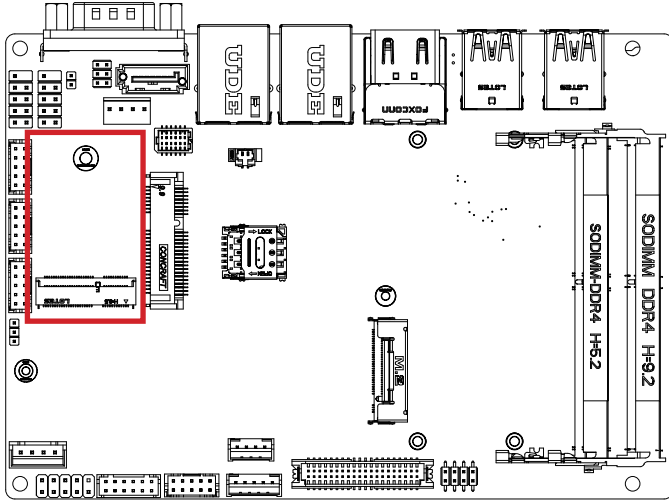

M.2 E Key Connector

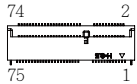

Pin No.	Definition	Pin No.	Definition
1	GND	2	3V
3	USB_Dp	4	3V
5	USB_Dn	6	NC
7	GND	8	NC
9	NC	10	NC
11	NC	12	NC
13	NC	14	NC
15	NC	16	NC
17	NC	18	GND
19	NC	20	NC
21	NC	22	NC
23	NC		

Pin No.	Definition	Pin No.	Definition
33	GND	32	NC
35	WLAN_TXp	34	NC
37	WLAN_TXn	36	NC

39	GND	38	CL_RST#
41	WLAN_RXp	40	CL_DATA
43	WLAN_RXn	42	CL_CLK
45	GND	44	NC
47	CLK_Dp	46	NC
49	CLK_Dn	48	NC
51	GND	50	SUSCLK
53	CLK_REQ	52	PCIE_RST
55	PCIE_WAKE	54	BT_Disable#
57	GND	56	WLAN_DISABLE
59	NC	58	NC
61	NC	60	NC
63	GND	62	NC
65	NC	64	NC
67	NC	66	NC
69	GND	68	NC
71	NC	70	NC
73	NC	72	3V
75	GND	74	3V

Connector PN	Vendor
APCI0095-P002A	LOTES
80152-8521	BELLWETHER

2.2.26 MPCIE (Mini PCIe slot)

26

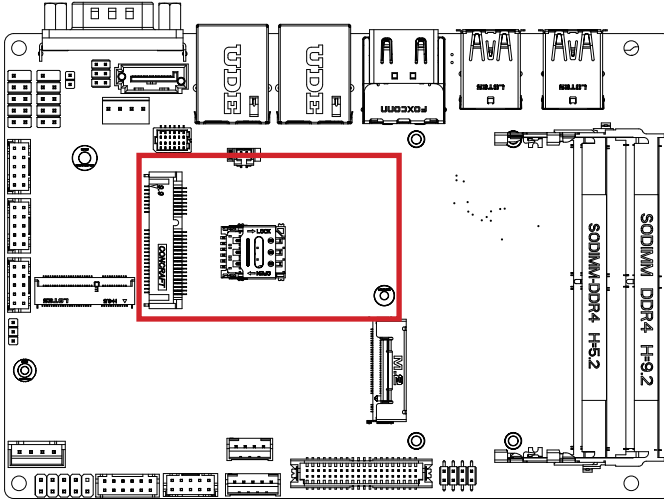

Mini PCIe Connector

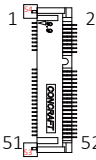

Pin No.	Definition	Pin No.	Definition
1	PCIE WAKE	2	3.3V
3	NC	4	GND
5	NC	6	NC
7	PCIe Clock Request	8	SIM PWR
9	GND	10	SIM DATA
11	PCIe Clock n	12	SIM Clock
13	PCIe Clock p	14	SIM Reset
15	GND	16	UIM VPP3
17	NC	18	GND
19	NC	20	WLAN_DISABLE

Pin No.	Definition	Pin No.	Definition
21	GND	22	Reset
23	PCIe RXn	24	3.3V
25	PCIe RXp	26	GND
27	GND	28	NC
29	GND	30	SMB Clock
31	PCIe TXn	32	SMB DATA
33	PCIe TXp	34	GND
35	GND	36	USB Dn
37	GND	38	USB Dp
39	3.3V	40	GND
41	3.3V	42	NC
43	GND	44	NC
45	NC	46	NC
47	NC	48	NC
49	NC	50	GND
51	NC	52	3.3V

Connector PN	Vendor
AS0B221-S99Q-7H	FOXCONN

2.2.27 BATTERY (Battery cable Connector)

27

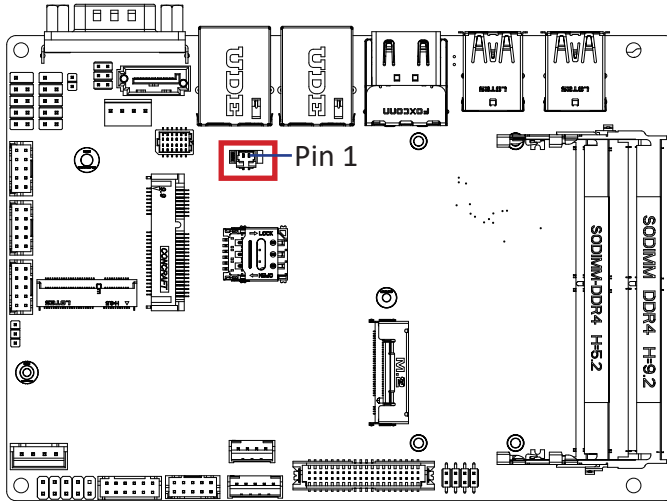

Battery cable Connector



Pin No.	Definition
1	3.3V
2	GND

Connector PN

85205-0270L

A1250WV-S-02PC

Vendor

ACES

JOINT-TECH

Connector type

1x2pin header, pitch 1.25mm

2.2.28 M2M_CPU (M.2 Slot, 2280 M-key)

28

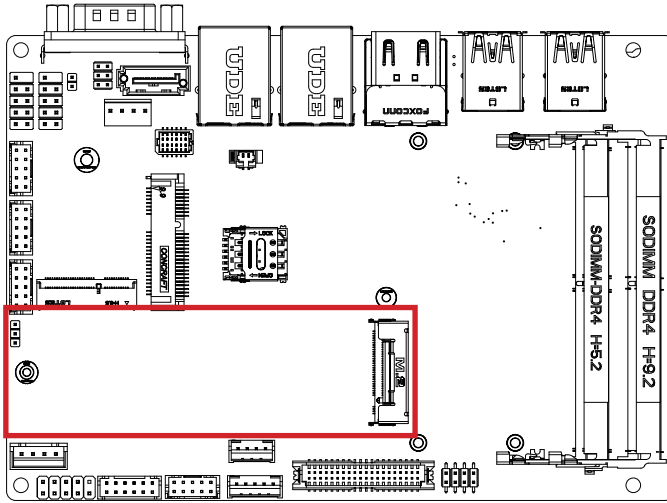

M.2 M Key Connector

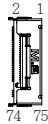

Pin No.	Definition	Pin No.	Definition
1	GND	2	3.3V
3	GND	4	3.3V
5	PCIE_RXn3	6	NC
7	PCIE_RXp3	8	NC
9	GND	10	M2_LED
11	PCIE_TXn3	12	3.3V
13	PCIE_TXp3	14	3.3V
15	GND	16	3.3V
17	PCIE_RXn2	18	3.3V
19	PCIE_RXp2	20	NC
21	GND	22	NC
23	PCIE_TXn2	24	NC
25	PCIE_TXp2	26	NC
27	GND	28	NC
29	PCIE_RXn1	30	NC
31	PCIE_RXp1	32	NC

Pin No.	Definition	Pin No.	Definition
33	GND	34	NC
35	PCIE_TXn1	36	NC
37	PCIE_TXp1	38	DEVS LP
39	GND	40	SMB Clock
41	SATA_RXp	42	SMB DATA
43	SATA_RXn	44	SMB ALERT
45	GND	46	NC
47	SATA_TXn	48	NC
49	SATA_TXp	50	PLT_RST
51	GND	52	CK_REQ
53	CLK_n	54	PCIE_WAKE#
55	CLK_p	56	NC
57	GND	58	NC

Pin No.	Definition	Pin No.	Definition
67	NC	68	SUSCLK
69	M2_SSD_Detect	70	3.3V
71	GND	72	3.3V
73	GND	74	3.3V
75	GND		

Connector PN	Vendor
2E0BC41-C85CM-LH	FOXCONN

Chapter 3

Chapter 3 – BIOS

3.1 Introduction

BIOS (Basic input/output system) provides hardware detailed information and boot-up options, which include firmware to control, set-up and test all hardware settings. Therefore, BIOS is the communication bridge between OS/application software and hardware.

3.1.1 How to Entering into BIOS menu

Once the system is power on, press the key as soon as possible to access into BIOS Setup program.

3.1.2 Function Keys to setup in BIOS Setup program

Function keys	Description
→←	Select Screen
↑↓	Select Item
Enter	Execute command or enter the submenu
+	Increase the numeric value or make changes
—	Decrease the numeric value or make changes
F1	General Help
F2	Previous Values
F3	Load Optimized Defaults Settings
F4	Save changes & Exit the BIOS Setup program
ESC	Exit the BIOS Setup program

3.2 The Main Menu

The main menu shows the basic system information. Use arrow keys to move among the items.

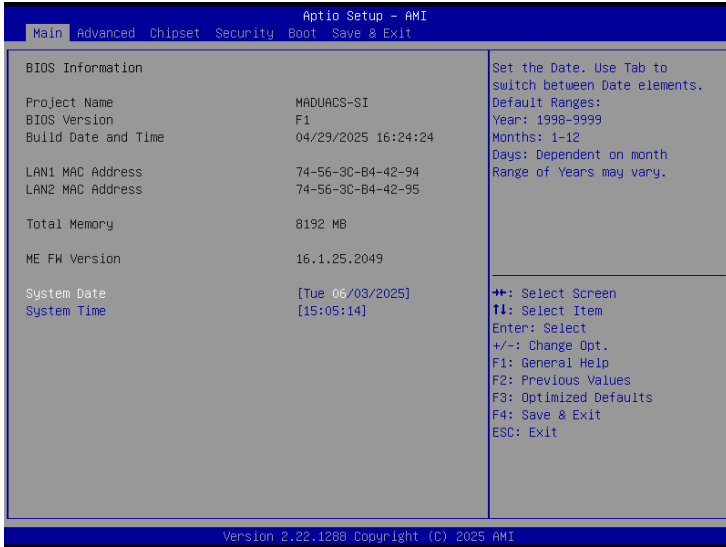

Items	Description
Project Name	Shows Project name information
BIOS Version	Shows the BIOS version of the system
Build Date and Time	Shows the Build Date and Time when the BIOS was created.
LAN1 MAC Address	Shows LAN1 MAC Address information
LAN2 MAC Address	Shows LAN2 MAC Address information
Total Memory	Shows the total memory size of the installed memory
ME FW version	Shows ME firmware version
System Date	Set the Date for the system (Format : Week - Month - Day - Year)
System Time	Set the time for the system (Format : Hour - Minute - Second)

3.3 Advanced

The Advanced menu is to configure the functions of hardware settings through submenu. Use arrow keys to move among the items, and press <Enter> to access into the related submenu.

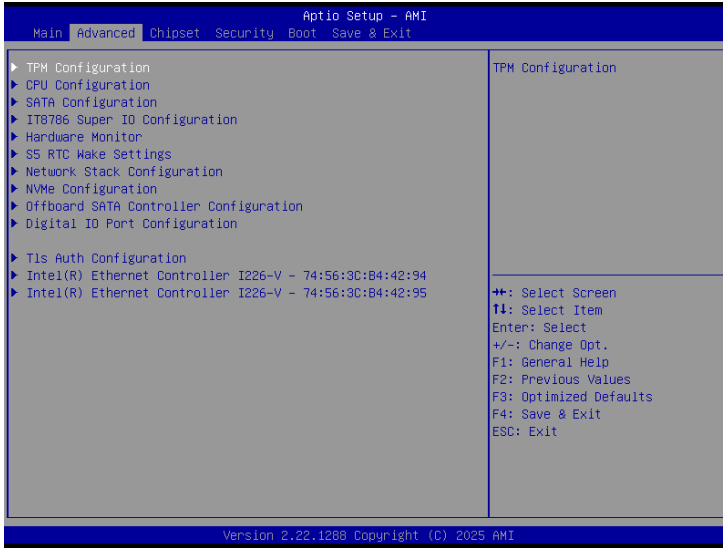

3.3.1 TPM Configuration

Use TPM Configuration submenu to choose TPM interface.

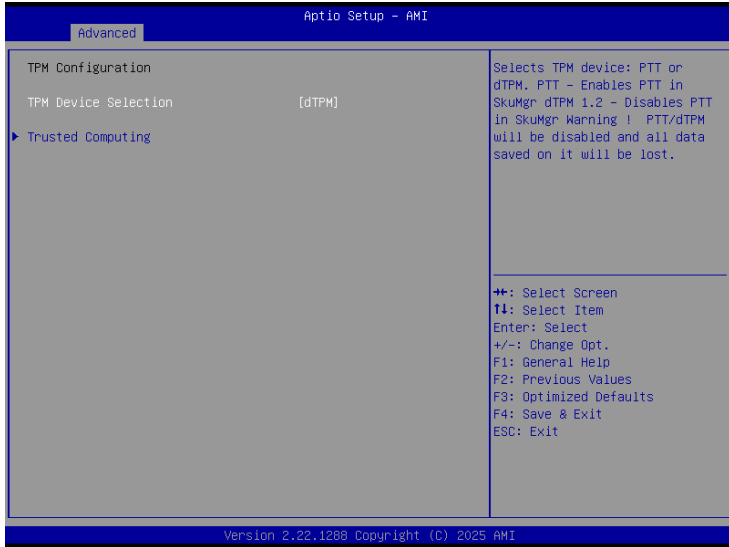

Item	Description
TPM Device Selection	PTT : Internal TPM dTPM : External TPM (When using External TPM module or having TPM chip on MB) (Default setting)

Trusted Computing : Shows TPM information, and TPM module configuration setting.



Item	Description
Security Device support	Enabled : Enables TPM feature (Default setting) Disabled : Disables TPM feature
Pending operation	None : No execution will be conducted (Default setting) TPM clear : Set to clear data on TPM

3.3.2 CPU Configuration

This submenu shows detailed CPU informations.

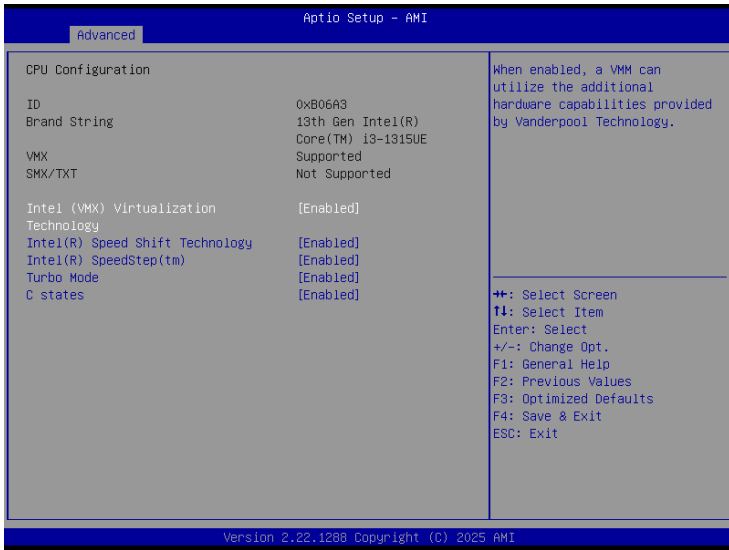

Item	Description
Intel (VMX) Virtualization Technology	Virtualization enhanced by Intel® Virtualization Technology will allow a platform to run multiple operating systems and applications in independent partitions. With virtualization, one computer system can function as multiple virtual systems. Enabled : Enables Intel Virtualization Technology (Default setting) Disabled : Disables Intel Virtualization Technology
Intel(R) Speed Shift Technology	To speed up CPU frequency transition time from basic frequency to maximum frequency. Enabled : Enables Intel(R) Speed Shift Technology Interrupt control (Default setting) Disabled : Disables Intel(R) Speed Shift Technology Interrupt control
Intel(R) SpeedStep(tm)	According to Intel CPU loading, Intel SpeedStep Technology will automatically adjust the CPU voltage and core frequency to decrease heat and power consumption for power saving. Enabled : Enables Intel SpeedStep Technology (Default setting) Disabled : Disables Intel SpeedStep Technology
Turbo Mode	Enabled : Enables Turbo Mode (Default setting) Disabled : Disables Turbo Mode
C states	Command CPU to enter into low power consumption mode when CPU is under idle mode. Enabled : Enables C states (Default setting) Disabled : Disables C states

3.3.3 SATA Configuration

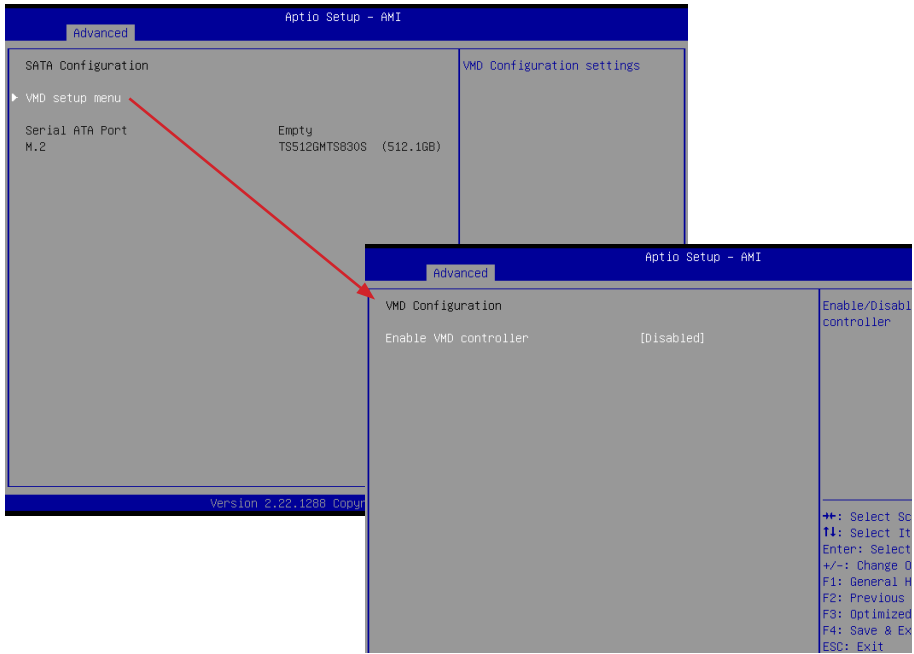

Item	Description
VMD setup menu / Enable VMD controller	Intel VMD feature helps you to control and manage NVMe PCIe SSD. Enabled : Enables Intel VMD feature Disabled : Disables Intel VMD feature (Default setting)
Serial ATA Port	shows 2.5"/3.5" SATA HDD/SSD information
M.2	shows M.2 SATA interface SSD information

3.3.4 IT8786 Super IO Configuration



Item	Description
Serial Port 1 Configuration	Press [Enter] to configure advanced items :
Serial Port 2 Configuration	Serial Port : Enabled : Enables allows you to configure the serial port settings Disabled : if Disabled, displays no configuration for the serial port
Serial Port 3 Configuration	Device settings : Display the specified Serial Port base I/O address and IRQ
Serial Port 4 Configuration	COM Port Mode : Choose RS-232, RS-422, or RS-485 feature

3.3.5 Hardware Monitor

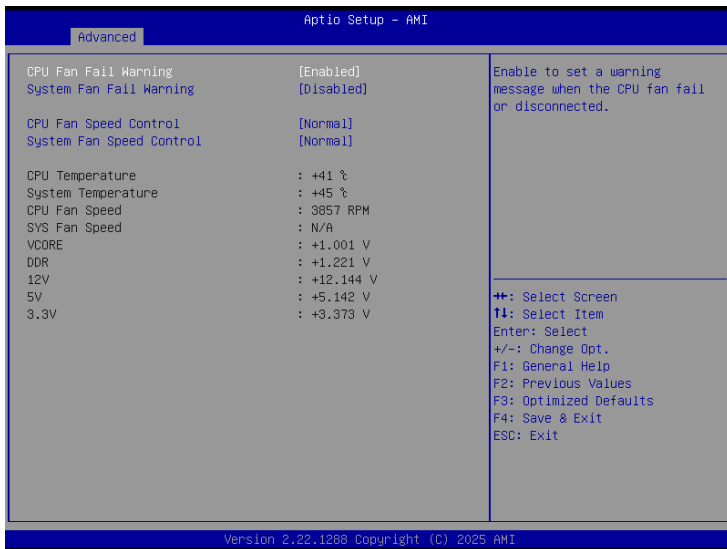

Item	Description
CPU Fan Fail Warning	Enabled : Enables CPU FAN Fail warning alert function (Default setting) Disabled : Disables CPU FAN Fail warning alert function
System Fan Fail Warning	Enabled : Enables to set a warning message when the system fan fail or disconnected. Disabled : Disables to set a warning message when the system fan fail or disconnected. (Default setting)
CPU Fan Speed Control	Normal : Fan speed set by BIOS default (Default setting) Full Speed : Set Fan operates at full speed
System Fan Speed Control	Normal : Fan speed set by BIOS default (Default setting) Full Speed : Set Fan operates at full speed
CPU Temperature	Shows current CPU temperature
System Temperature	Shows current system temperature
CPU Fan Speed	Shows current CPU fan Speed
SYS Fan Speed	Shows current System fan Speed

3.3.6 S5 RTC Wake Settings

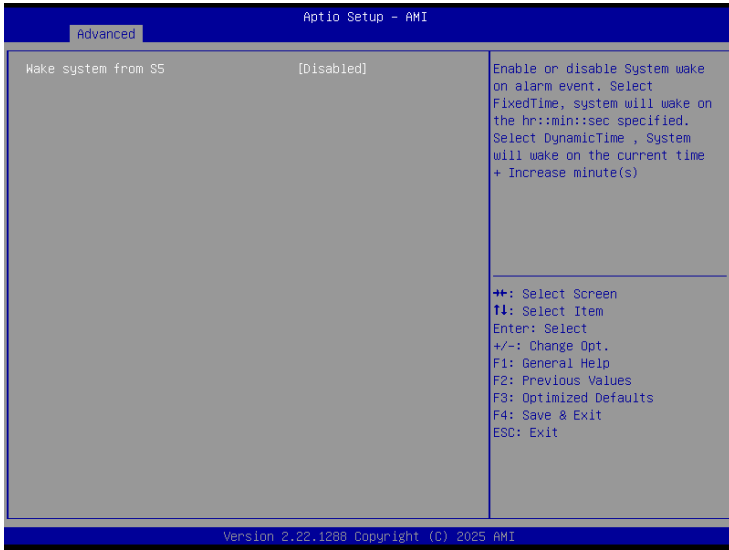

Item	Description
Wake system from S5	Enable or Disable System to wake on a specific time. Disabled : Disables system to wake on a specific time (Default setting) Fixed Time : Enables system to wake on a specific time (Format : hr : min : sec)

3.3.7 Network Stack Configuration

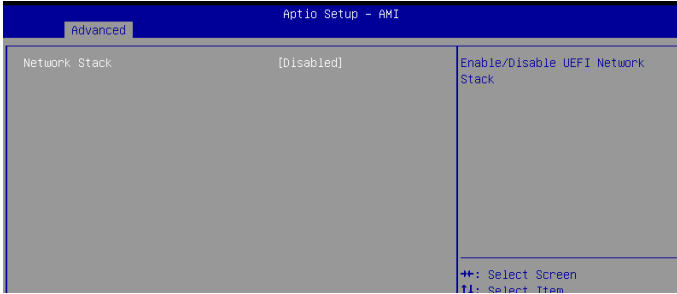

When Network stack is enabled :

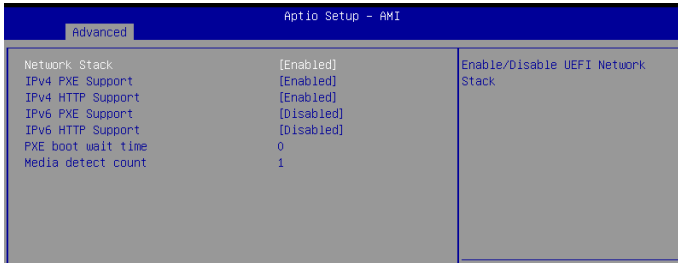

Item	Description
Network Stack	When system is power on, install LAN driver under UEFI mode Disabled : Disables UEFI Network Stack (Default setting) Enabled : Enables UEFI Network Stack
IPv4 PXE Support	When Network stack is enabled : Disabled : Disables IPv4 PXE Support Enabled : Enables IPv4 PXE Support
IPv4 HTTP Support	When Network stack is enabled : Disabled : Disables IPv4 HTTP Support Enabled : Enables IPv4 HTTP Support
IPv6 PXE Support	When Network stack is enabled : Disabled : Disables IPv6 PXE Support Enabled : Enables IPv6 PXE Support
IPv6 HTTP Support	When Network stack is enabled : Disabled : Disables IPv6 HTTP Support Enabled : Enables IPv6 HTTP Support
PXE boot wait time	Wait time in seconds, or use ESC key to abort the PXE boot.
Media detect count	Number of times the presence of media will be checked.

3.3.8 NVMe Configuration

NVMe Configuration shows information when your M.2 NVMe PCIe SSD is installed.

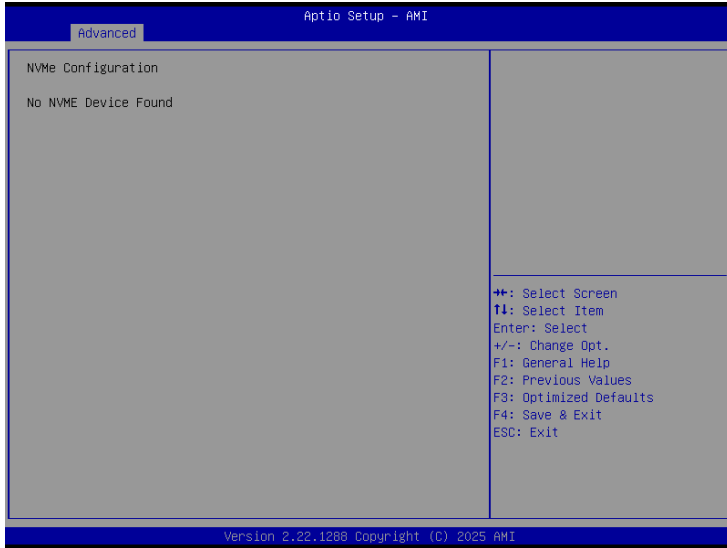

3.3.9 Offboard SATA Controller Configuration

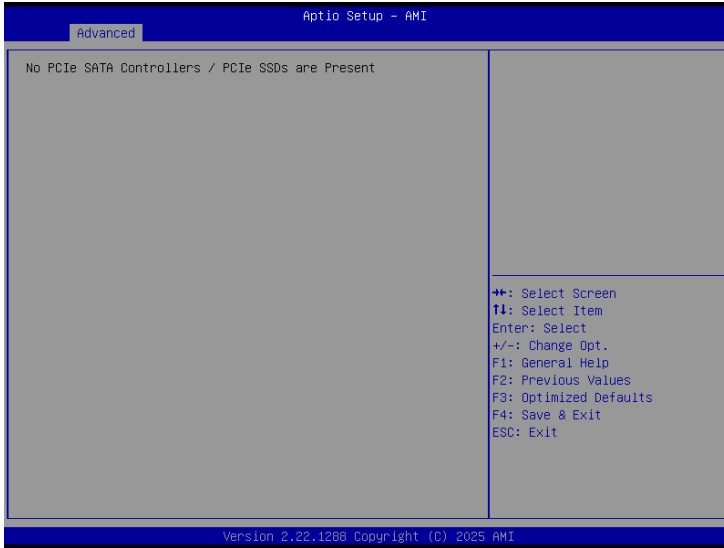

3.3.10 Digital IO Port Configuration

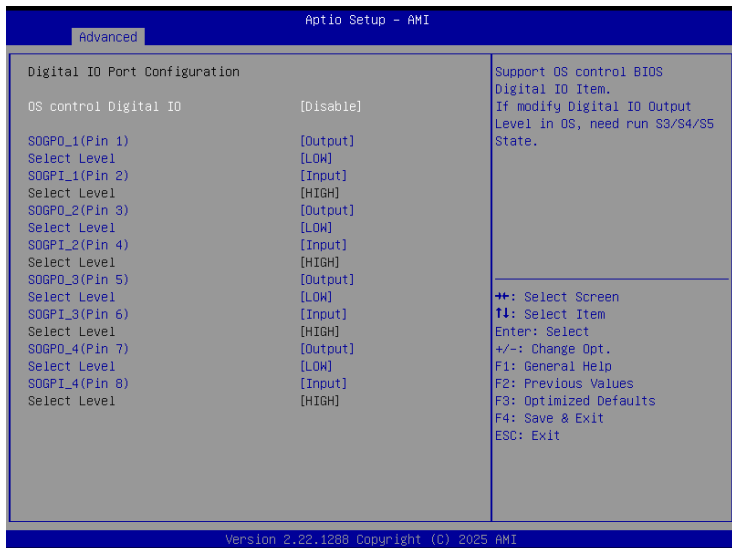

Item	Description
OS control Digital IO	<p>Disabled : If Digital IO Output value/level is modified in OS, they will not be memorized and kept. (Default setting)</p> <p>Enabled : If Digital IO Output value/level is modified in OS, they will be memorized and kept.</p>
SOGPO_1 (Pin 1) SOGPI_1 (Pin 2) SOGPO_2 (Pin 3) SOGPI_2 (Pin 4) SOGPO_3 (Pin 5) SOGPI_3 (Pin 6) SOGPO_4 (Pin 7) SOGPI_4 (Pin 8)	Configure Digital IO Input or Output values for each pin.

3.3.11 Tls Auth Configuration

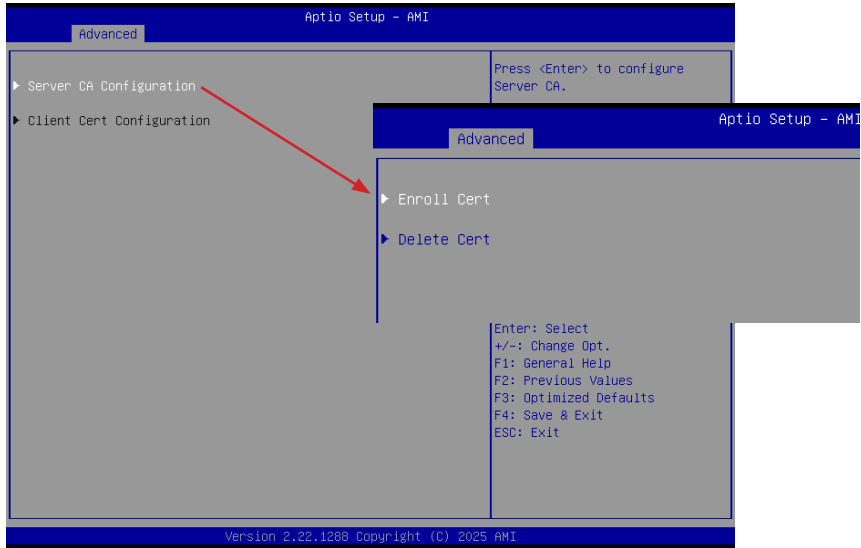

Item	Description
Enroll Cert	<p>Press [Enter] to configure advanced items :</p> <p>Server CA Configuration :</p> <p>Enroll Cert :</p> <ol style="list-style-type: none"> 1. Enroll Cert Using File 2. Cert GUID : Input digit character in 11111111-2222-3333-4444-1234567 890ab format. 3. Commit Changes and Exit 4. Discard Changes and Exit

3.3.12 Intel(R) Ethernet Controller I226-V - 74:56:3C:B4:42:94 (MAC address may varied based on different motherboard)

Shows Intel Ethernet controller information

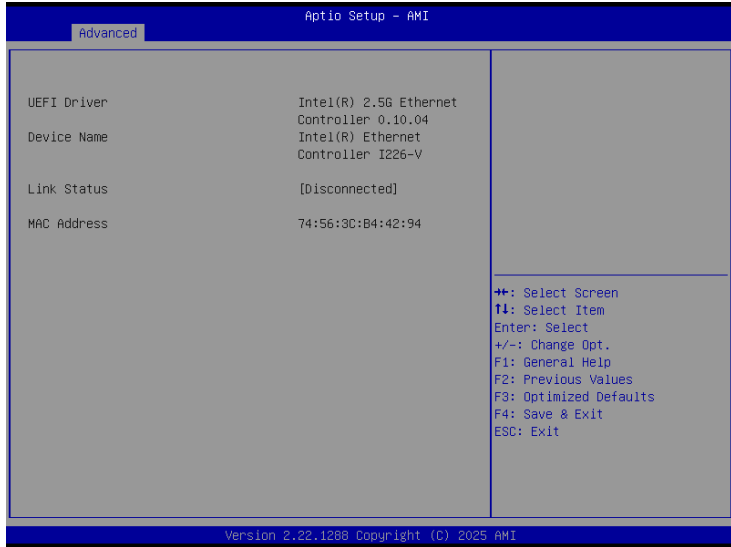

NOTE : MAC address may varied based on different motherboard

3.3.13 Intel(R) Ethernet Controller I226-V - 74:56:3C:B4:42:95 (MAC address may varied based on different motherboard)

Shows Intel Ethernet controller information

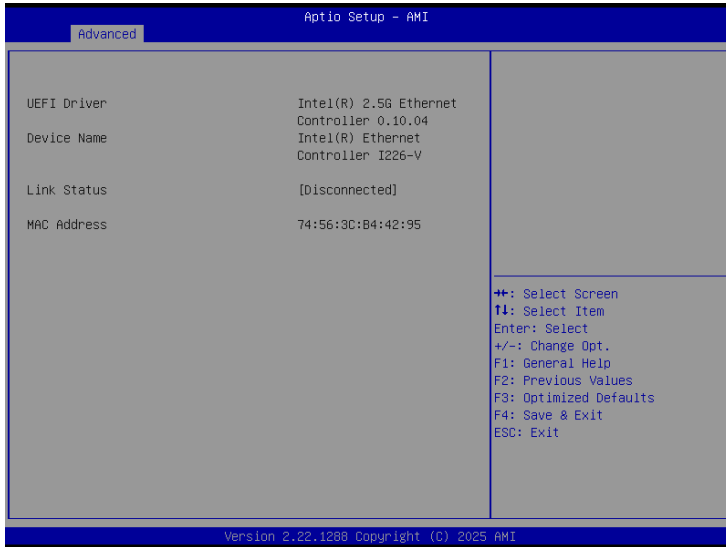

NOTE : MAC address may varied based on different motherboard

3.4 Chipset



Item	Description
VT-d	Enabled : Enables VT-d function (Default setting) Disabled : Disables VT-d function
DVMT Pre-Allocated	Use DVMT Pre-Allocated to set the amount of system memory which is installed to the integrated graphics processor Option items : 32M , 64M , 128M , 256M (Default setting)
Onboard LAN1 Onboard LAN2	Enable/Disable onboard LAN controller Enabled : Enables onboard LAN controller (Default setting) Disabled : Disables onboard LAN controller
HD Audio	Enable/Disable onboard audio controller Enabled : Enables onboard audio controller (Default setting) Disabled : Disables onboard audio controller
ErP Lowest Power State Mode	Enable/Disable power saving funtion Enabled : Enables ERP Lowest Power State Mode Disabled : Disabled ERP Lowest Power State Mode (Default setting)

Restore AC Power Loss	To set which option the system should returns if a sudden power loss occurred Power off : Do not power on when the power is back (Default setting) Power on : System power on when the power is back Last state : Restore the system to the state before power loss occurs
LVDS Support	Disabled : Disables LVDS Support (Default setting) Enabled : Enables LVDS Support
LVDS Brightness Level	When LVDS Support is enabled : To modified the backlight brightness of the LVDS panel Option items : 10%, 20%, 30%, 40%, 50%, 60%, 70%, 80%, 90%, 100% (Default Setting)
Watchdog Timer	Enable/Disable Watchdog Timer function Enabled : Enables Watchdog Timer function Disabled : Disabled Watchdog Timer function (Default setting)
BIOS Lock	Enable/Disable BIOS Lock function Enabled : Enables BIOS Lock function (Default setting) Disabled : Disabled BIOS Lock funtion

3.5 Security

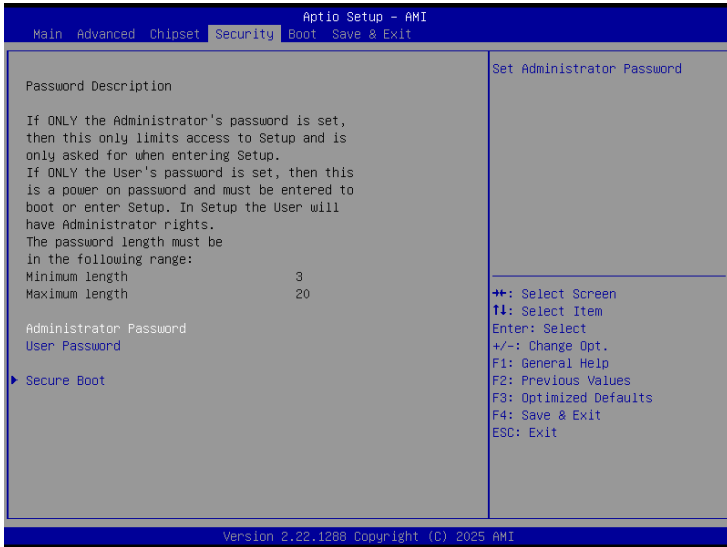

Item	Description
Administrator Password	To set up Administrator's password Minimum length : 3 Maximum length : 20
User Password	To set up User's password Minimum length : 3 Maximum length : 20
Secure Boot	Press <Enter> to configure the advanced items



Item	Description
Secure Boot	Secure Boot requires all the applications that are running during the booting process to be pre-signed with valid digital certificates Enabled : Enables Secure Boot function Disabled : Disables Secure Boot function (Default setting)
Secure Boot Mode	Standard : Standard mode Custom : Custom mode (Default setting)
Restore Factory Keys	To restore factory settings Yes : Agree to restore factory settings No : Cancel to restore factory settings
Reset To Setup Mode	Yes : Agree to setup mode No : Cancel to setup mode
Key Management	Enables expert users to modify Secure boot policy variables without full authentication Press <Enter> to configure the advanced items

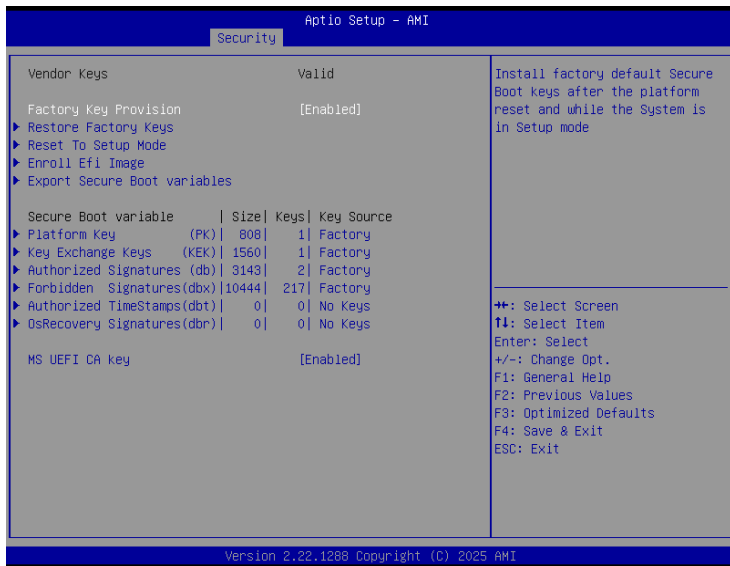

Item	Description
Factory Key Provision	Install factory default Secure Boot keys after the platform reset and while the system is in Setup mode Enabled : Enables Factory Key Provision (Default setting) Disabled : Disables Factory Key Provision
Restore Factory Keys	To restore factory settings
Reset To Setup Mode	Delete all Secure boot key databases from NVRAM
Enroll Efi Image	Allow the image to run in Secure Boot mode
Export Secure Boot variables	Copy NVRAM content of Secure Boot variables to files in a root folder on a file system device

Item	Description
Platform Key (PK)	These items allows you to enroll factory defaults or load Certificates from a file.
Key Exchange Keys (KEK)	
Authorized Signatures (db)	
Forbidden Signatures (dbx)	
Authorized TimeStamps (dbt)	
OsRecovery Signatures (dbr)	
MS UEFI CA Key	Device Guard ready system must not list 'Microsoft UEFI CA' Certificate in Authorized Signature database(db)

3.6 Boot

This Boot menu allows you to set/change system boot options

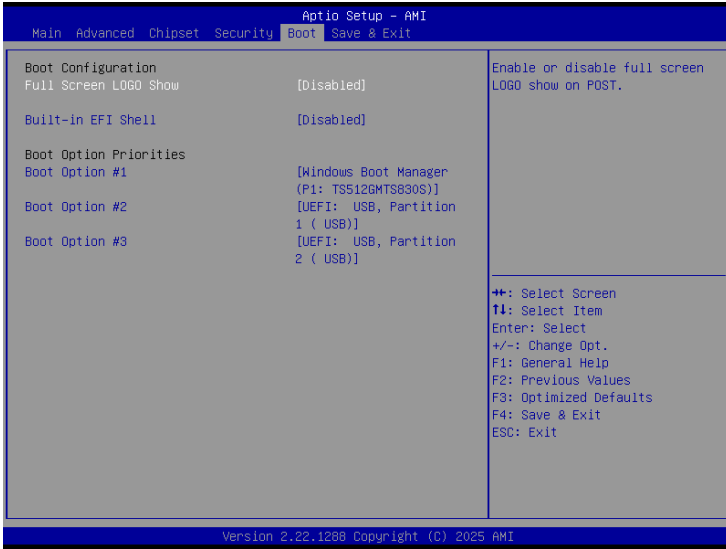

Item	Description
Full Screen LOGO Show	Enable/Disable full screen LOGO show on POST screen Enabled : Enables Full screen LOGO Show on POST screen Disabled : Disables Full screen LOGO Show on POST screen (Default setting)
Built-in EFI Shell	Enable/Disable Built-in EFI Shell Enabled : Enables Built-in EFI Shell Disabled : Disables Built-in EFI Shell (Default setting)
Boot Option #1 Boot Option #2 Boot Option #3	Shows the information of the storage that be installed in the system Choose/set the boot priority

3.7 Save & Exit



Item	Description
Save Changes and Reset	After configuring all the options that you wish to change, choose this option to save all the changes and reboot the system Yes : Agree to save and reset No : Cancel to save and reset
Discard Changes and Reset	Choose this option to reboot the system without saving any changes Yes : Agree to discard changes and reset No : Cancel to discard changes and reset
Restore Defaults	Restore/Load default values for all the setup options Yes : Agree to load optimized defaults No : Cancel to load optimized defaults
Me FW Image Re-Flash	Enable/Disable Me FW image re-flash function Enabled : Enables Me FW image re-flash function Disabled : Disables Me FW image re-flash function (Default setting)