

# QBiX-Pro-ARUA255H-A1

# QBiX-Pro-ARUA225H-A1

---

QBiX-Pro Industrial Embedded System  
Quick Start Guide

## Copyright Notice

---

This document is copyrighted, 2025. All rights are reserved. The original manufacturer reserves the right to make improvements to the products described in this manual at any time without notice.

No part of this manual may be reproduced, copied, translated, or transmitted in any form or by any means without the prior written permission of the original manufacturer. Information provided in this manual is intended to be accurate and reliable. However, the original manufacturer assumes no responsibility for its use, or for any infringements upon the rights of third parties that may result from its use.

The material in this document is for product information only and is subject to change without notice. While reasonable efforts have been made in the preparation of this document to assure its accuracy, GIGAIPC assumes no liabilities resulting from errors or omissions in this document, or from the use of the information contained herein.

GIGAIPC reserves the right to make changes in the product design without notice to its users.

## Acknowledgement

---

All other products' name or trademarks are properties of their respective owners.

- Microsoft Windows is a registered trademark of Microsoft Corp.
- Intel, Pentium, Celeron, and Xeon are registered trademarks of Intel Corporation
- Core, Atom are trademarks of Intel Corporation
- ITE is a trademark of Integrated Technology Express, Inc.
- IBM, PC/AT, PS/2, and VGA are trademarks of International Business Machines Corporation.

All other product names or trademarks are properties of their respective owners.

## Packing List

---

Before setting up your product, please make sure the following items have been shipped:

Item	Quantity
System kit	1
3-pin Terminal Blocks Male Plug (25IO0-5ESDV0-D2R)	1
2-pin Terminal Blocks Male Plug (25IO0-EC3812-D2R)	1
SATA Cable (25CRI-070000-S9R)	1
HDD screw, M3 x 8L (25KSG-130081-K1R)	4
Thermal pad for Memory (25ST3-200086-T5R)	1
Exsiccator (25g)	1

If any of these items are missing or damaged, please contact your distributor or sales representative immediately.

## About this Document

---

This User's Manual contains all the essential information, such as detailed descriptions and explanations on the product's hardware and software features (if any), its specifications, dimensions, jumper/connector settings/definitions, and driver installation instructions (if any), to facilitate users in setting up their product.

Users may refer to the [GIGAIPC.com](http://GIGAIPC.com) for the latest version of this document.

## Safety Precautions

---

Please read the following safety instructions carefully. It is advised that you keep this manual for future references

1. All cautions and warnings on the device should be noted.
2. Make sure the power source matches the power rating of the device.
3. Position the power cord so that people cannot step on it. Do not place anything over the power cord.
4. Always completely disconnect the power before working on the system's hardware.
5. No connections should be made when the system is powered as a sudden rush of power may damage sensitive electronic components.
6. If the device is not to be used for a long time, disconnect it from the power supply to avoid damage by transient over-voltage.
7. Always disconnect this device from any AC supply before cleaning.
8. While cleaning, use a damp cloth instead of liquid or spray detergents.
9. Make sure the device is installed near a power outlet and is easily accessible.
10. Keep this device away from humidity.
11. Place the device on a solid surface during installation to prevent falls
12. Do not cover the openings on the device to ensure optimal heat dissipation.

13. Watch out for high temperatures when the system is running.
14. Do not touch the heat sink or heat spreader when the system is running
15. Never pour any liquid into the openings. This could cause fire or electric shock.
16. As most electronic components are sensitive to static electrical charge, be sure to ground yourself to prevent static charge when installing the internal components. Use a grounding wrist strap and contain all electronic components in any static-shielded containers.
17. If any of the following situations arises, please the contact our service personnel:
  - i. Damaged power cord or plug
  - ii. Liquid intrusion to the device
  - iii. Exposure to moisture
  - iv. Device is not working as expected or in a manner as described in this manual
  - v. The device is dropped or damaged
  - vi. Any obvious signs of damage displayed on the device
- 18. DO NOT LEAVE THIS DEVICE IN AN UNCONTROLLED ENVIRONMENT WITH TEMPERATURES BEYOND THE DEVICE'S PERMITTED STORAGE TEMPERATURES (SEE CHAPTER 1) TO PREVENT DAMAGE.**
19. This product should be connected by means of a power cord to a socket-outlet with earthing connection.

## FCC Statement

---

### **Warning!**



This device complies with Part 15 FCC Rules. Operation is subject to the following two conditions: (1) this device may not cause harmful interference, and (2) this device must accept any interference received including interference that may cause undesired operation.

### **Caution:**

*There is a danger of explosion if the battery is incorrectly replaced. Replace only with the same or equivalent type recommended by the manufacturer. Dispose of used batteries according to the manufacturer's instructions and your local government's recycling or disposal directives.*

### **Attention:**

*Il y a un risque d'explosion si la batterie est remplacée de façon incorrecte. Ne la remplacer qu'avec le même modèle ou équivalent recommandé par le constructeur. Recycler les batteries usées en accord avec les instructions du fabricant et les directives gouvernementales de recyclage.*

## High Temperature Warning

---

(1) This equipment is intended to be used in Restrict Access Location. The access can only be gained by Skilled person or by Instructed person who have been instructed about the metal chassis of the equipment is so hot that Skilled person have to pay special attention or take special protection.

Only authorized by well trained professional person can access the restrict access location.

(2) External metal parts are hot!! Before touching it, special attention or protection is necessary



## Table Contents

<b>QBiX-Pro Industrial Embedded System Quick Start Guide</b>	<b>1</b>
Copyright Notice .....	2
Acknowledgement .....	3
Packing List.....	4
About this Document.....	5
Safety Precautions .....	6
FCC Statement.....	8
High Temperature Warning .....	8
 <b>Chapter 1 - Product Specifications</b>	 <b>13</b>
1.1 Specifications .....	15
 <b>Chapter 2 – QBiX-Pro-ARUA255H-A1 (QP-255UA-SI) QBiX-Pro-ARUA225H-A1 (QP-225UA-SI) Industrial Embedded System Kit</b>	 <b>17</b>
2.1 Dimension .....	18
2.2 Getting Familiar with Your Unit.....	19
2.3 A) Memory Installation: DDR5 SO-DIMM/CSO-DIMM ....	21
2.4 B) Mini PCIe Card Installation: How to safely install the Mini PCIe Card .....	22
2.5 C) M.2 SSD Installation: How to safely install the M.2 2280 SSD .....	23
2.6 D) Wireless Module: How to safely install the Module (Wireless Module inclusion may vary based on local	

	distribution) .....	24
2.7	E) 2.5" HDD/SSD installation: How to install 2.5" HDD/SSD .....	25
2.8	Antenna Installation (Antenna inclusion may vary based on local distribution) .....	26
2.9	Wall mount Bracket Installation.....	27
2.10	VESA mount Bracket Installation .....	28
2.11	Cable Pin-define .....	29
2.12	Support .....	30
2.13	Safety and Regulatory Information.....	31

## **Chapter 3 – Hardware Information 32**

3.1	Jumpers and Connectors .....	33
3.2.1	CPU_FAN (CPU fan connector) .....	36
3.2.2	SYS_FAN (System fan connector) .....	37
3.2.3	COM1 (Serial Port (RS-232/422/485 & RI/5V/12V)) .....	38
3.2.4	LAN2 (LAN connector).....	39
3.2.5	LAN1 (LAN connector).....	40
3.2.6	HDMI21 (HDMI connector) .....	41
3.2.7	USB32_2 (USB 3.2 Gen 2x1 connector).....	42
3.2.8	USB32_1 (USB 3.2 Gen 2x1 connector) .....	43
3.2.9	SODIMM1, SODIMM2 (DDR5 SO-DIMM Slot).....	44
3.2.10	LSW (LVDS resolution jumper) .....	45
3.2.11	LVDS (LVDS connector).....	46
3.2.12	BKL_CN (Backlight control header) .....	47
3.2.13	SPKR (Speaker out connector) .....	48

- 3.2.14 FP\_AUDIO (Front Audio connector) ..... 49
- 3.2.15 GPIO\_CNT (General Purpose input/output header) ..... 50
- 3.2.16 CAN\_BUS (CANBus header) ..... 51
- 3.2.17 SYS\_PANEL (Front panel header) ..... 52
- 3.2.18 DC\_IN (DC IN 1x4 pin power connector) ..... 53
- 3.2.19 AT\_CN (AT/ATX mode select jumper) ..... 54
- 3.2.20 COM2, COM3, COM4 (Serial port header, RS-232/422/485)  
..... 55
- 3.2.21 FUSB1, FUSB2 (USB 2.0 headers) ..... 56
- 3.2.22 JCOM1 (RI# pin RI#/5V/12V Select jumper for COM1  
Port)..... 57
- 3.2.23 SATA0 (SATA 6Gb/s connector) ..... 58
- 3.2.24 SATAPWR (SATA power connector)..... 59
- 3.2.25 M2E (M.2 Slot, 2230 E-key)..... 60
- 3.2.26 MPCIE (Mini PCIe slot)..... 61
- 3.2.27 BATTERY (Battery cable Connector) ..... 62
- 3.2.28 M2M (M.2 Slot, 2280 M-key)..... 63

**Chapter 4 – BIOS 64**

- 4.1 Introduction ..... 65
- 4.2 The Main Menu..... 66
- 4.3 Advanced ..... 67
- 4.3.1 SATA Configuration ..... 68
- 4.3.2 TPM Configuration..... 69
- 4.3.3 CPU Configuration ..... 71

4.3.4	IT5782 Super IO Configuration .....	73
4.3.5	Hardware Monitor .....	74
4.3.6	S5 RTC Wake Settings .....	75
4.3.7	Network Stack Configuration.....	76
4.3.8	NVMe Configuration .....	77
4.3.9	Digital IO Port Configuration .....	78
4.3.10	Intel(R) Ethernet Controller I226-LM - 30:56:0F:45:5D:90 (MAC address may varied based on different motherboard) .....	79
4.3.11	Intel(R) Ethernet Controller I226-V - 30:56:0F:45:5D:91 (MAC address may varied based on different motherboard) .....	80
4.4	Chipset .....	81
4.5	Security .....	83
4.6	Boot.....	86
4.7	Save & Exit .....	87

# Chapter 1

---

## Chapter 1 - Product Specifications



## 1.1 Specifications

System	QBiX-Pro-ARUA255H-A1 (QP-255UA-SI)	QBiX-Pro-ARUA225H-A1 (QP-225UA-SI)
Dimension	System Size : 178W x 125D x 52.7H (mm)	
CPU	Intel® Core™ Ultra 7 Processor 255U Intel® 3, 12 cores, 2P+8E+2LPE, 14 threads, up to 5.20 GHz	Intel® Core™ Ultra 5 Processor 225U Intel® 3, 12 cores, 2P+8E+2LPE, 14 threads, up to 4.8 GHz
Chipset	SoC	
Memory	2 x DDR5 SO-DIMM/CSO-DIMM sockets, Max. Capacity 32 GB Support Dual Channel DDR5 5600/6400 MHz memory modules	
Ethernet	2 x 2.5GbE LAN Ports (Intel® I226V & I226LM)	
Graphics support	Integrated Graphics Processor - Intel® Graphics: 2 x HDMI 2.1 ports, supporting a maximum resolution of 7680x4320 @60Hz (HDMI 2 port support HDMI CEC) ※For HDMI CEC support, please enable it from BIOS (refer page 81~82)  (2 independent display outputs)	
Audio	Realtek® ALC269	
Storage	1 x 2.5" HDD/SSD (SATA 6Gb/s)	
Expansion Slots	1 x 2280 M.2 M-Key (PCIe Gen 4x4, SATA 6Gb/s) 1 x 2230 M.2 E-Key 1 x Full-size Mini PCIe with SIM slot	
Front I/O	2 x RJ45 LAN Ports 4 x USB 3.2 Gen 2x1 2 x HDMI 1 x Power button with LED 1 x HDD LED 1 x COM Port (RS-232/422/485 & RI/5V/12V) 1 x External Antenna Hole (Optional)	
Rear I/O	2 x USB 2.0 2 x COM Ports (RS-232/422/485) 1 x GPIO (8 bits) 1 x Combo Audio Jack (Headphone & Headset) 1 x Remote control 1 x 3-pin Terminal Block	
Side I/O	2 x External Antenna Holes (Optional)	

System	QBiX-Pro-ARUA255H-A1 (QP-255UA-SI)	QBiX-Pro-ARUA225H-A1 (QP-225UA-SI)
TPM	Onboard TPM 2.0 security chip INFINEON SLB9670VQ2.0	
Power	+9V~36VDC (Full Range)	
Operation Temperature	Operating temperature: 0°C to 50°C Operating humidity: 40°C @ 20-95% (non-condensing) Non-operating temperature: -40°C to 85°C Non-operating humidity: 60°C @ 95% (non-condensing) Use wide temperature range memory and storage	
Vibration During Operation	Operation: IEC 60068-2-64, 3 Grms, random, 5 ~ 500 Hz, 1 hr / Per Axis, with SSD/M.2 2280 Non-operation: IEC 60068-2-6, 2 G, Sine, 10 ~ 500 Hz, 1 Oct/min, 1 hr / Per Axis	
Shock During Operation	Operation: IEC 60068-2-27, 50 G, half sine, 11 ms duration, With SSD	
Packaging Content	Carton size: 505 x 333 x 231 (mm) Packing Capacity: 5pcs  Including: Screw I Head for 2.5" HDD M3x8L x 4 (P/N: 25KSG-130081-K1R) Thermal Pad for Memory x 1 (P/N: 25ST3-200086-T5R) 2-pin Terminal Blocks Male Plug x 1 (P/N: 25IO0-EC3812-D2R) SATA Cable x 1 (P/N: 25CRI-070000-S9R) 3-pin Terminal Blocks Male Plug x 1 (P/N: 25IO0-5ESDV0-D2R)	
Order Information	System: 6BQP255UAMR-SI (Box packing)	System: 6BQP225UAMR-SI (Box packing)

## Chapter 2

---

Chapter 2 – QBiX-Pro-ARUA255H-A1 (QP-255UA-SI)  
QBiX-Pro-ARUA225H-A1 (QP-225UA-SI)  
Industrial Embedded System Kit

# 2.1 Dimension

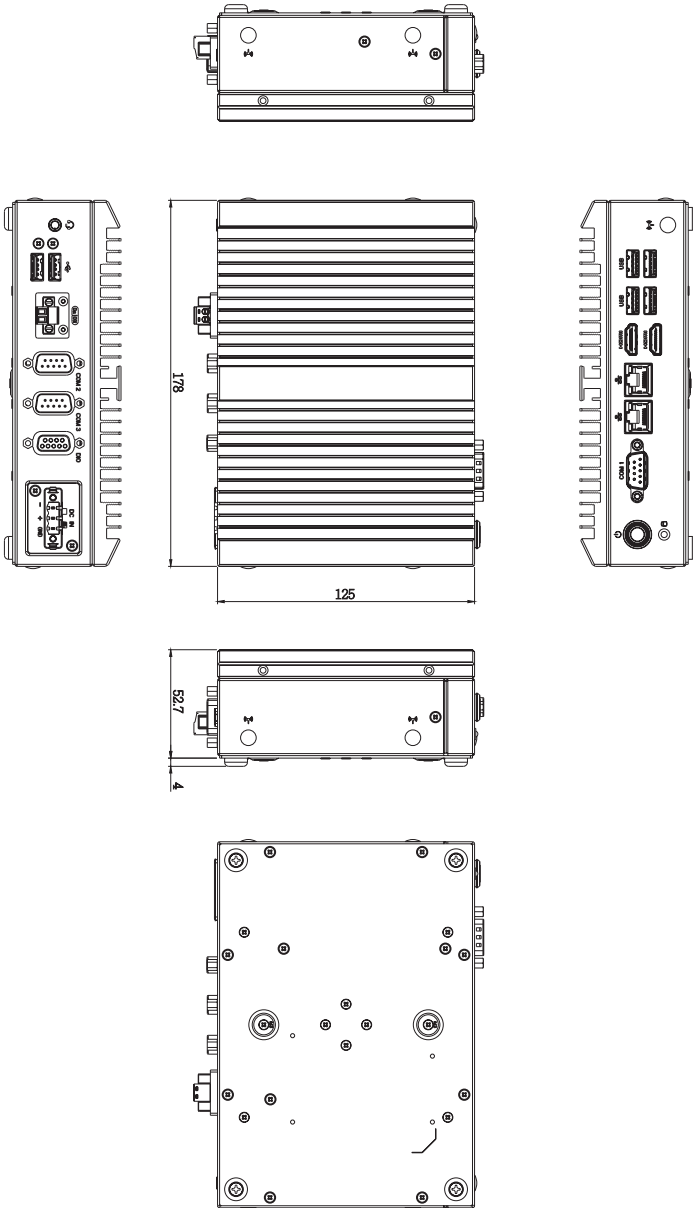

## 2.2 Getting Familiar with Your Unit

### [Front Side]

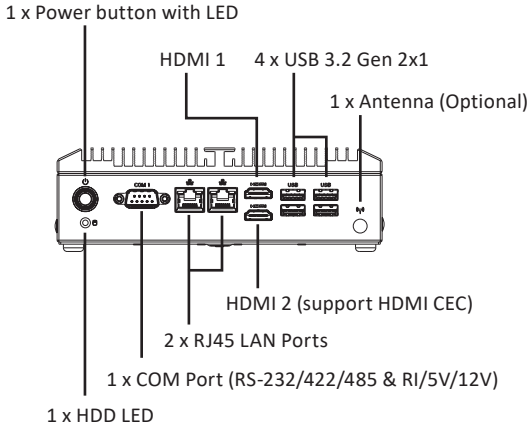

### [Left Side]

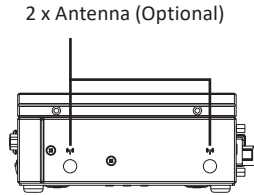

### [Rear Side]

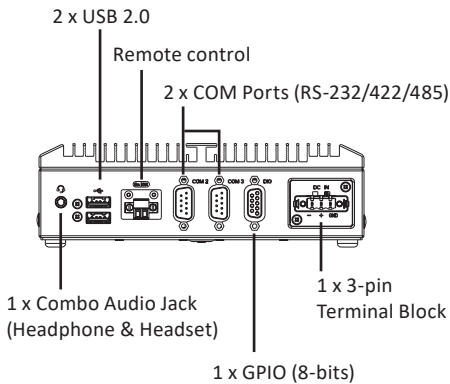

### [Right Side]

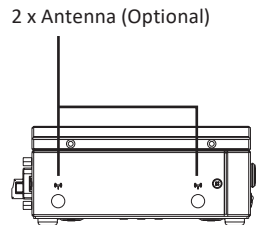

## [Install]

- \* Before opening the case, make sure to unplug the power cord.
- \* Before Connecting the power, make sure to fasten the case securely.

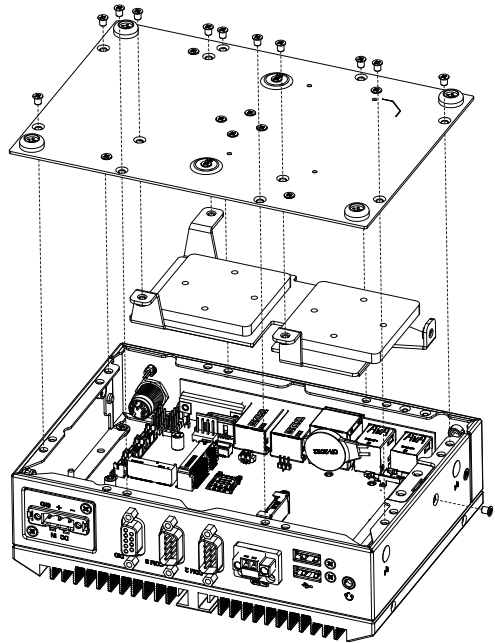

## [Bottom PCB Side]

Information	
A	2 x DDR5 SO-DIMM/CSO-DIMM sockets
B	1 x Mini PCIe slot with SIM Slot

Information	
C	1 x M.2 slot 2280 M-key
D	1 x M.2 slot 2230 E-key
E	support 2.5'' Hard drive/SSD

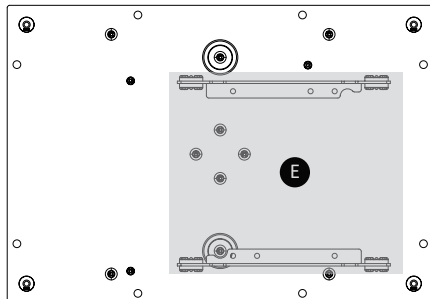
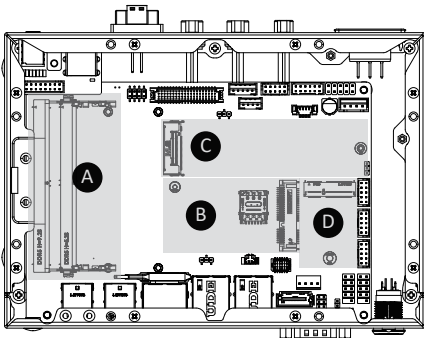

## 2.3 A) Memory Installation: DDR5 SO-DIMM/CSO-DIMM

**1**

Carefully insert SO-DIMM/CSO-DIMM memory modules.

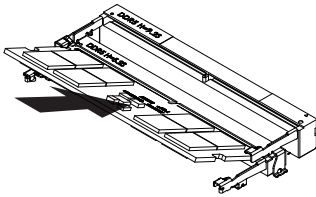
**2**

Push down until the modules click into place.

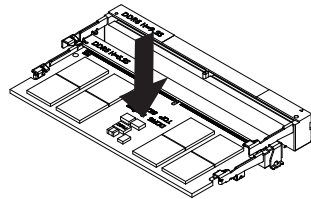
**3**

Carefully insert SO-DIMM/CSO-DIMM memory modules.

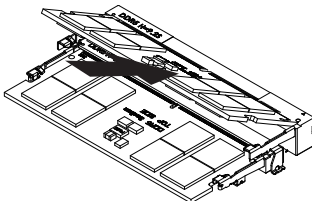
**4**

Push down until the modules click into place.

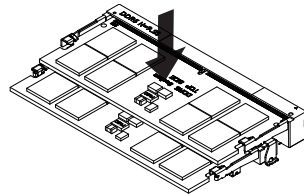

## 2.4 B) Mini PCIe Card Installation: How to safely install the Mini PCIe Card

---

1

Remove the screw from the screw hole (Location : MSO4)

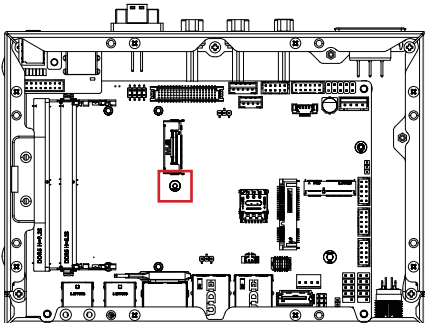

2

Carefully insert the Mini PCIe Card into the slot.

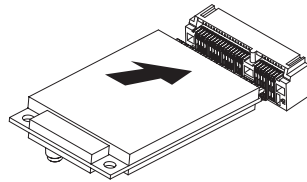

3

Secure the Mini PCIe Card with screw.

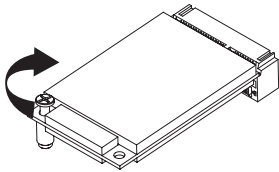

## 2.5 C) M.2 SSD Installation: How to safely install the M.2 2280 SSD

**1**

Remove the screw from the screw hole (Location : MSO2)

**2**

Carefully insert the M.2 SSD into the slot, and secure with the screw.

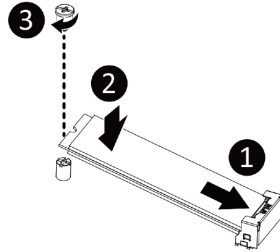
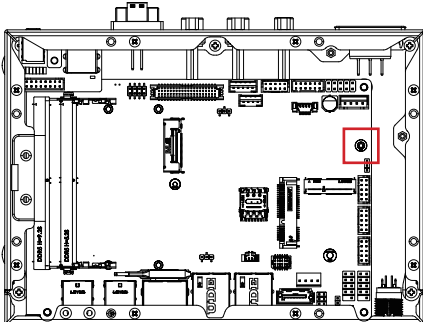

## 2.6 D) Wireless Module: How to safely install the Module (Wireless Module inclusion may vary based on local distribution)

1

Remove the screw from the screw hole (Location : MSO1)

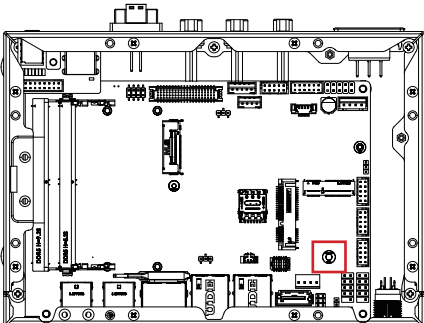

2

Carefully insert the wireless module into the M.2 slot.

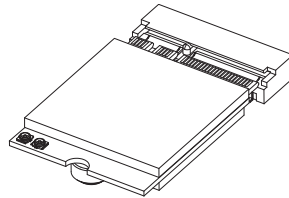

3

Lock the screw in the middle.

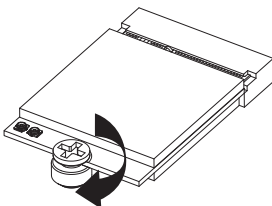

4

Install the antenna on the left side of the connection wireless module down.

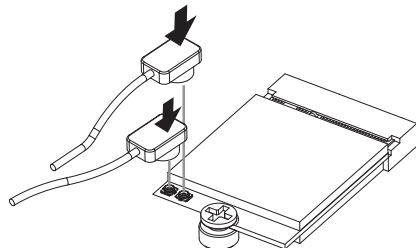

## 2.7 E) 2.5" HDD/SSD installation: How to install 2.5" HDD/SSD

- 1 Remove 3 screws to remove the bracket. (Corresponding 3 screw locations can be found in the bottom right drawing.)
- 2 First : assemble the SATA cable and 2.5" HDD/SSD.  
Second : remove 2 release papers on the thermal pad which located on the bottom cover.  
Third : install 2.5" HDD/SSD (Gold finger of 2.5" HDD/SSD must face down),  
and secure with 4 screws.  
Fourth : install the bracket back with 3 screws.
- 3 Assemble the SATA cable on the SATA connector, and lock the bottom cover.

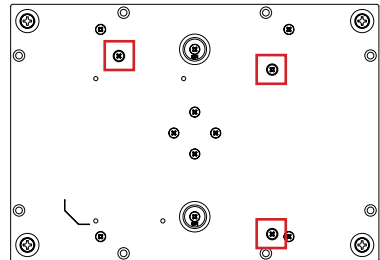
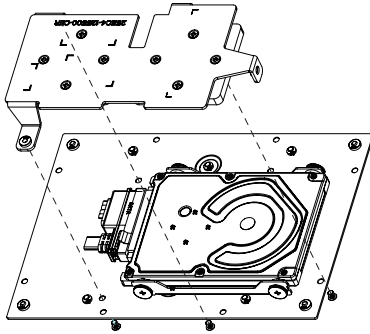

## 2.8 Antenna Installation (Antenna inclusion may vary based on local distribution)

---

1

Carefully insert the antennas into the connectors.

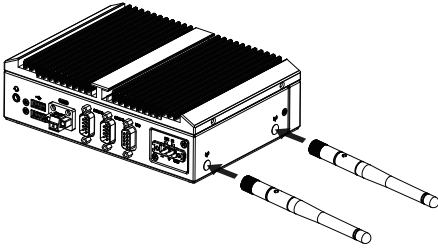

2

Turn the antennas clockwise until they are completely secure on the connectors.

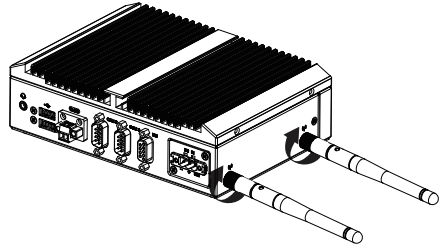

3

Flip up the antenna heads so that they are perpendicular to the machine.

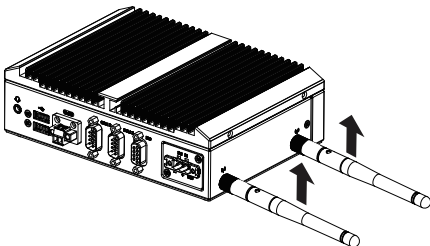

## 2.9 Wall mount Bracket Installation

**1** Remove 4 screws on the bottom cover.

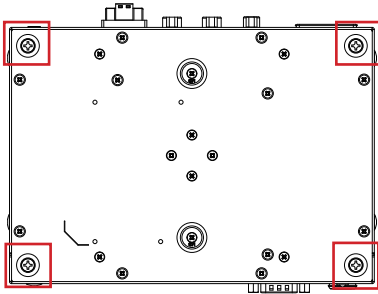

**2** Install the wall mount brackets using the screws included in the optional kit.

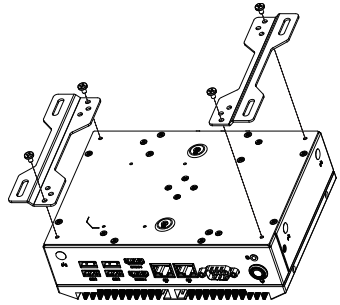

NOTE : The wall mount brackets are the optional parts.

**3** Wall mount bracket installation completed.

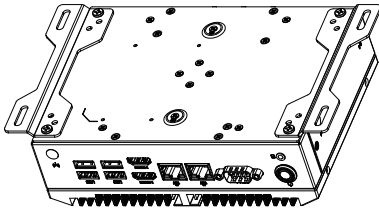

NOTE : The wall mount brackets are the optional parts.

**4** Suggest screws as below for different type of surface.

**Concrete wall**



Electric drill



Wall anchors  
ST3.2 x 30mm



Self-tapping screw  
ST3.2 x 25mm

**Wooden wall**



Self-tapping screw  
ST3.2 x 25mm

**Machine**



Machine screw  
M3 x 10mm pan head, with  
Spring washer + flat washer

## 2.10 VESA mount Bracket Installation

1

Lock 2 screws on the bottom cover.

Screws type : M3-3L x 2pcs, including in the optional kit.

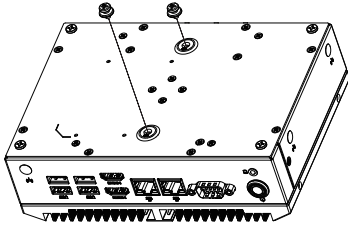

2

Attach the VESA mount to the rear of a compatible display using the screws provided.

VESA hole patterns : 75 x 75mm and 100 x 100mm  
Screws type : M4-10L x 4pcs

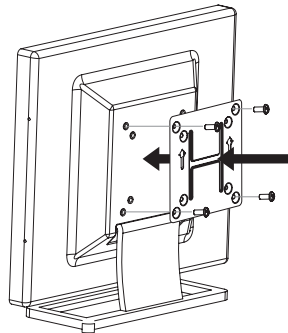

NOTE : The wall mount brackets are the optional parts.

3

The QBix-Pro can now be mounted by sliding the device into place.

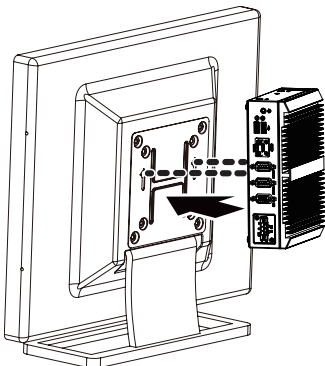

NOTE : The wall mount brackets are the optional parts.

## 2.11 Cable Pin-define

### 1. DB9 COM (25CF8-210620-S9R)

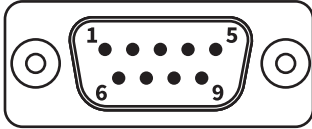

DB9 Pin Define

DB9 Pin	RS-232	RS-422 Full Duplex	RS-485 Half Duplex
1	DCD	TXD-	D-
2	RXD	TXD+	D+
3	TXD	RXD+	-
4	DTR	RXD-	-
5	GND		
6	DSR	-	-
7	RTS	-	-
8	CTS	-	-
9	RI	-	-

### 2. DBP DIO (25CR5-150606-S9R)

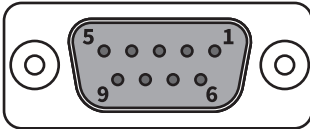

DBP DIO Pin Define

DBP DIO Pin	Pin Name
1	GPIO-output_1
2	GPIO-input_1
3	GPIO-output_2
4	GPIO-input_2
5	GPIO-output_3
6	GPIO-input_3
7	GPIO-output_4
8	GPIO-input_4
9	5V

### 3. Remote control connector (25CR5-150606-S9R)

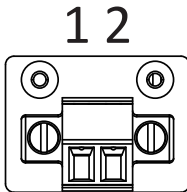

Remote control Pin define

Remote control pin	Pin Name
1	Power button +
2	Power button -

## 2.12 Support

---

- For AVL list, go to: <http://www.gigaipc.com>
- To download the latest drivers, go to: <http://www.gigaipc.com>
- For product support, go to: <http://www.gigaipc.com>

## 2.13 Safety and Regulatory Information

---

Risk of explosion if the battery is replaced with an incorrect type. Batteries should be recycled where possible.

Disposal of used Batteries must be in accordance with local environmental regulations.

Failure to use the included Power Adapter may violate regulatory compliance and may expose the user to safety hazards.

**HDMI™**  
HIGH DEFINITION MULTIMEDIA INTERFACE



At the end of its serviceable life, this product should not be treated as household or general waste. It should be handed over to the applicable collection point for the recycling of electrical and electronic equipment, or returned to the supplier for disposal.

# Chapter 3

---

## Chapter 3 – Hardware Information

### 3.1 Jumpers and Connectors

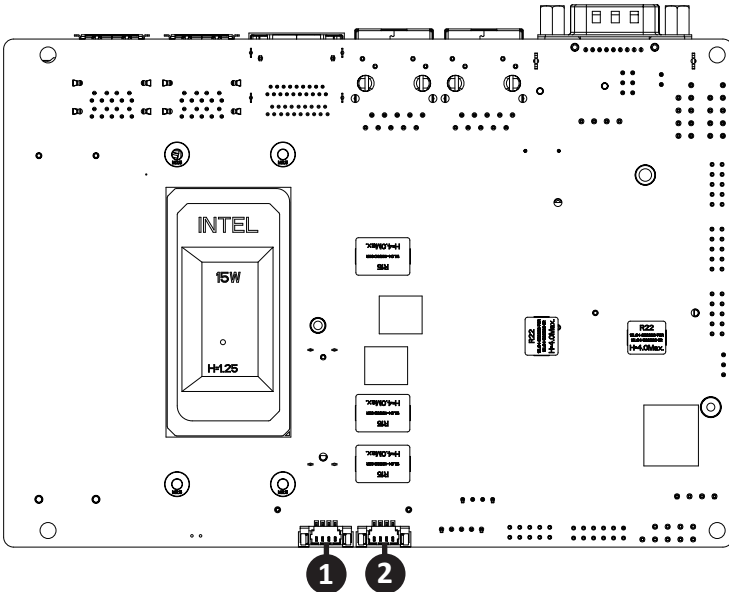
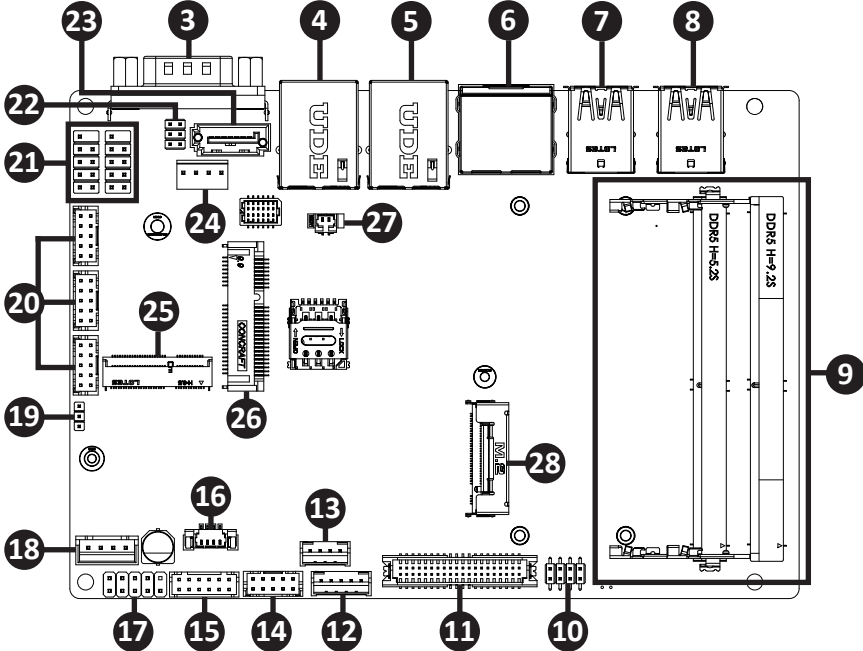



No	Code	Description
1	CPU_FAN	CPU fan connector
2	SYS_FAN	System fan connector
3	COM1	Serial Port (RS-232/422/485 & RI/5V/12V)
4	LAN2	LAN connector
5	LAN1	LAN connector
6	HDMI21	HDMI connector
7	USB32_2	USB 3.2 Gen 2x1 connector
8	USB32_1	USB 3.2 Gen 2x1 connector
9	SODIMM1 SODIMM2	DDR5 SO-DIMM Slot
10	LSW	LVDS resolution jumper
11	LVDS	LVDS connector
12	BKL_CN	Backlight control header
13	SPKR	Speaker out connector
14	FP_AUDIO	Front Audio connector
15	GPIO_CNT	General purpose input / ouput header
16	CAN_BUS	CANBus header
17	SYS_PANEL	Front panel header
18	DC_IN	DC IN 1x4 pin power connector
19	AT_CN	AT/ATX mode select jumper
20	COM2, COM3, COM4	Serial port header (RS-232/422/485)
21	FUSB1, FUSB2	USB 2.0 headers

No	Code	Description
22	JCOM1	RI# pin RI#/5V/12V Select jumper for COM1 Port
23	SATA0	SATA 6Gb/s connector
24	SATAPWR	SATA power connector
25	M2E	M.2 Slot, 2230 E-key
26	MPCIE	Mini PCIe slot
27	BATTERY	Battery cable connector
28	M2M	M.2 Slot, 2280 M-key

## 3.2.1 CPU\_FAN (CPU fan connector)

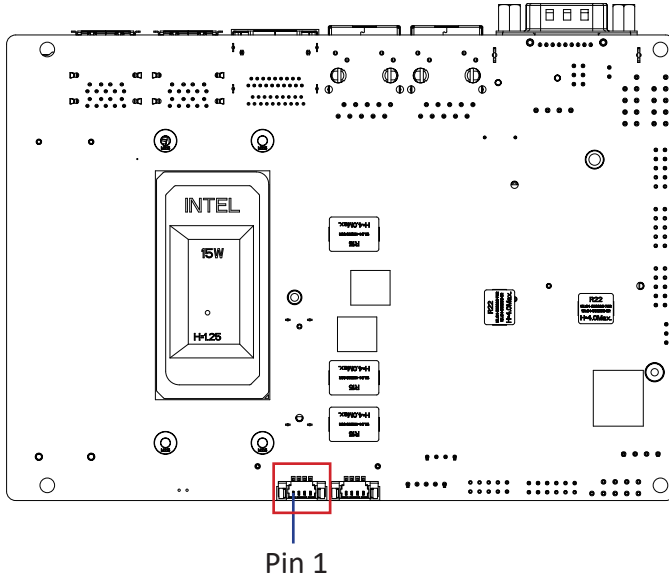
1



CPU fan Connector	
 1234	
Pin No.	Definition
1	GND
2	12V
3	Detect
4	Speed control

Connector PN	Vendor
85205-0470N	ACES
A1250WV-S-04PC	JOINT-TECH
Connector type	
1x4pin header, pitch 1.25mm	

## 3.2.2 SYS\_FAN (System fan connector)

2

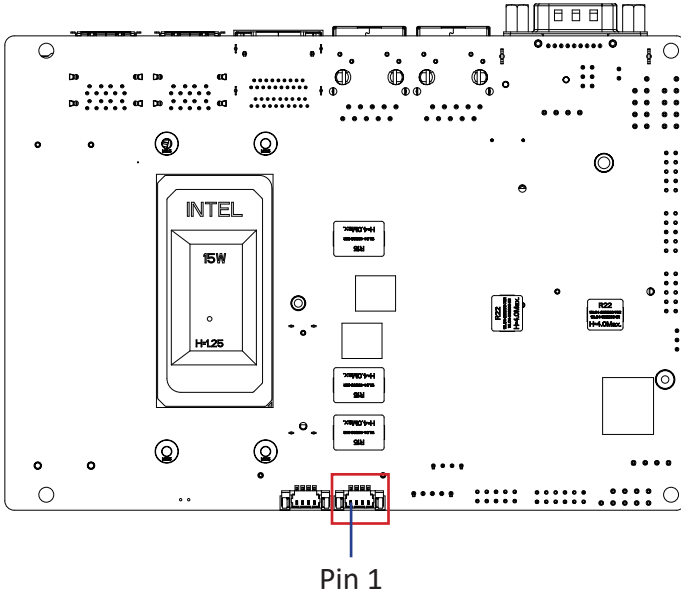

Pin 1

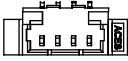
System fan Connector	
 1 2 3 4	
Pin No.	Definition
1	GND
2	12V
3	Detect
4	Speed control

Connector PN	Vendor
85205-0470N	ACES
A1250WV-S-04PC	JOINT-TECH
Connector type	
1x4pin header, pitch 1.25mm	

## 3.2.3 COM1 (Serial Port (RS-232/422/485 & RI/5V/12V))

3

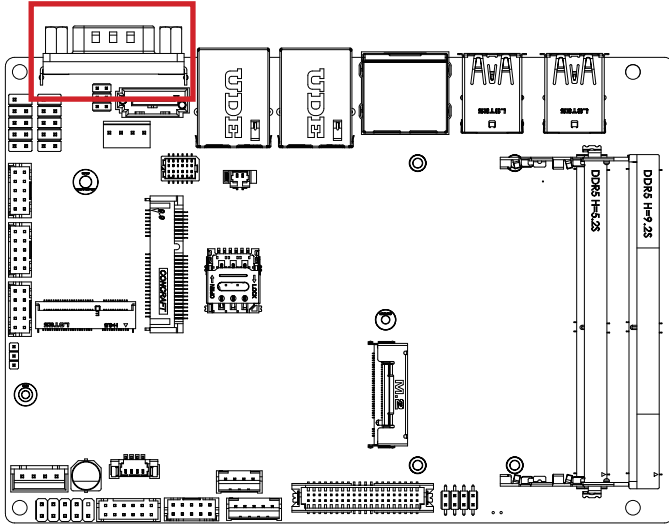

Serial Port connector

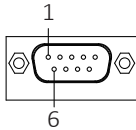

Connector PN

SM41D1P1122N33NQ

Vendor

FENYING

Pin No.	RS-232	RS-422 Full Duplex	RS-485 Half Duplex
1	DCD	TXD-	D-
2	RXD	TXD+	D+
3	TXD	RXD+	-
4	DTR	RXD-	-
5	GND		
6	DSR	-	-
7	RTS	-	-
8	CTS	-	-
9	RI	-	-

### 3.2.4 LAN2 (LAN connector)

4

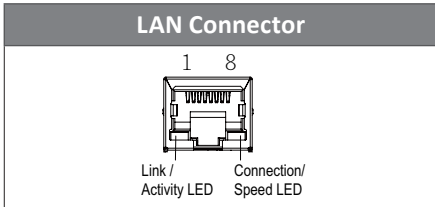
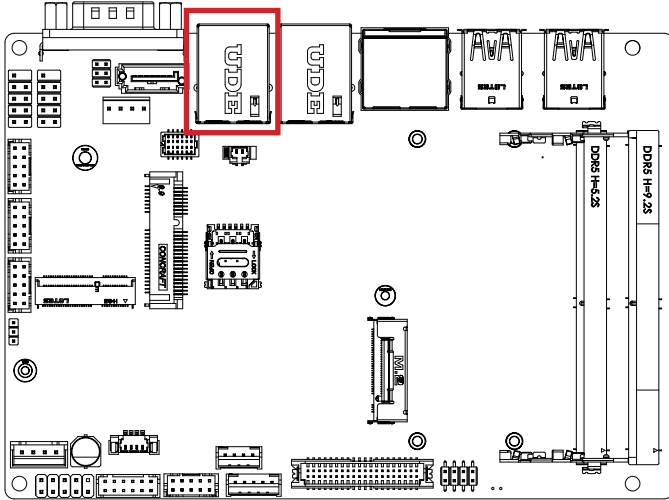

Pin No.	Definition
1	BI_DA+
2	BI_DA-
3	BI_DB+
4	BI_DC+
5	BI_DC-
6	BI_DB-
7	BI_DD+
8	BI_DD-

State	Description
Yellow On	2.5Gbps data rate
Green On	1Gbps data rate
Off	100Mbps data rate
Off	10Mbps data rate

Connector PN	Vendor
RB1-GB-0009	UDE

## 3.2.5 LAN1 (LAN connector)

5

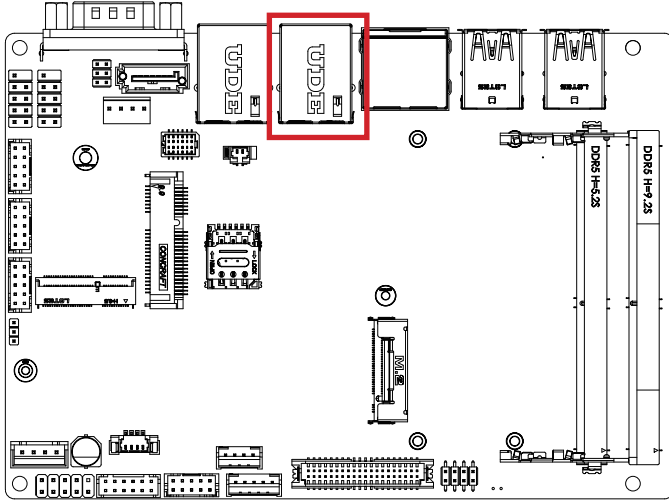

**LAN Connector**

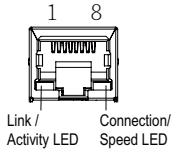

Pin No.	Definition
1	BI_DA+
2	BI_DA-
3	BI_DB+
4	BI_DC+
5	BI_DC-
6	BI_DB-
7	BI_DD+
8	BI_DD-

State	Description
Yellow On	2.5Gbps data rate
Green On	1Gbps data rate
Off	100Mbps data rate
Off	10Mbps data rate

Connector PN	Vendor
RB1-GB-0009	UDE

### 3.2.6 HDMI21 (HDMI connector)

6

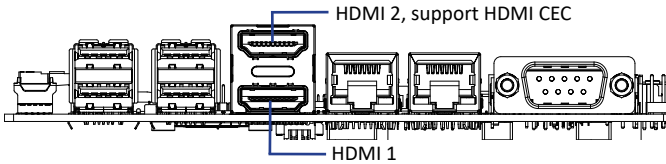
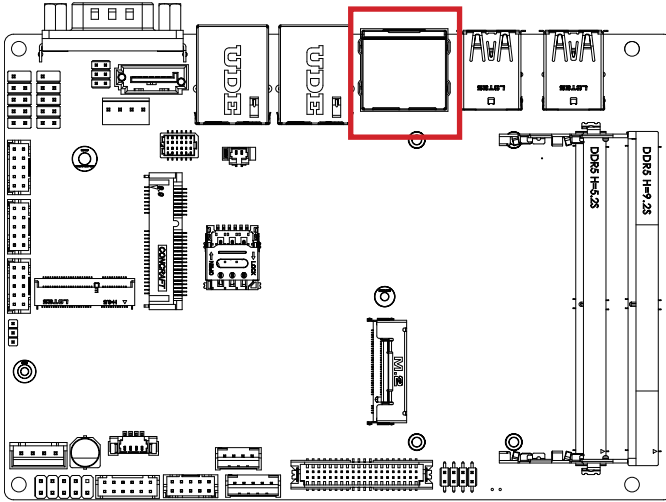

HDMI Connector

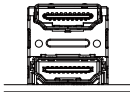

HDMI 1 connector

Pin No.	Definition	Pin No.	Definition
1	HDMI_D2p	11	GND
2	GND	12	HDMI_CLKn
3	HDMI_D2n	13	NC
4	HDMI_D1p	14	NC
5	GND	15	HDMI_SCL
6	HDMI_D1n	16	HDMI_SDA
7	HDMI_D0p	17	GND
8	GND	18	5V
9	HDMI_D0n	19	HDMI_HPDP
10	HDMI_CLKp		

HDMI 2 connector

Pin No.	Definition	Pin No.	Definition
1	HDMI_D2p	11	GND
2	GND	12	HDMI_CLKn
3	HDMI_D2n	13	HDMI CEC
4	HDMI_D1p	14	NC
5	GND	15	HDMI_SCL
6	HDMI_D1n	16	HDMI_SDA
7	HDMI_D0p	17	GND
8	GND	18	5V
9	HDMI_D0n	19	HDMI_HPDP
10	HDMI_CLKp		

Connector PN	Vendor
WDDMM-38ACL1B1HW3Z1	WINWIN

## 3.2.7 USB32\_2 (USB 3.2 Gen 2x1 connector)

7

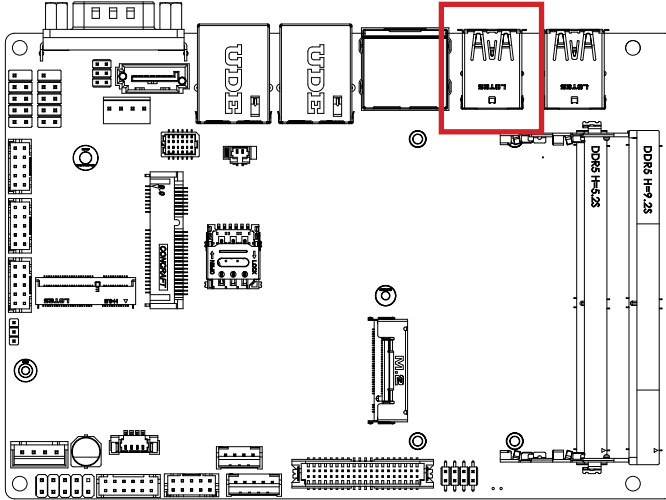

USB Connector



Connector PN

18-A5950-6A33-A

Vendor

TCONN

Pin No.	Definition	Pin No.	Definition
1	5V	10	5V
2	USB_Dn	11	USB_Dn
3	USB_Dp	12	USB_Dp
4	GND	13	GND
5	USB3_RXn	14	USB3_RXn
6	USB3_RXp	15	USB3_RXp
7	GND	16	GND
8	USB3_TXn	17	USB3_TXn
9	USB3_TXp	18	USB3_TXp

### 3.2.8 USB32\_1 (USB 3.2 Gen 2x1 connector)

8

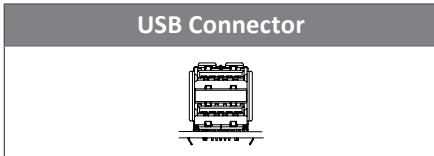
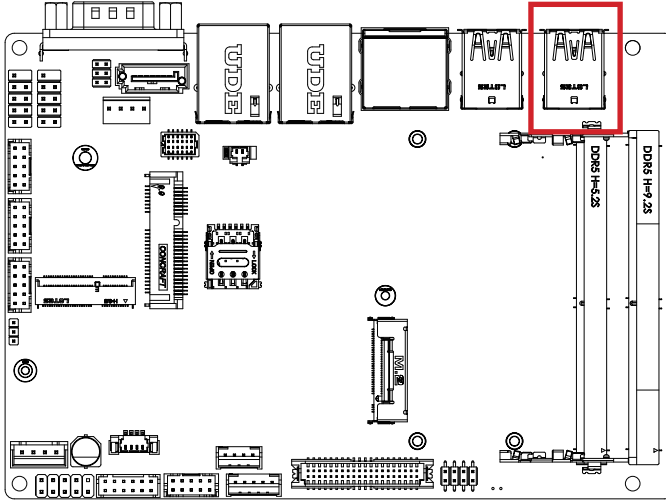

Connector PN	Vendor
18-A5950-6A33-A	TCONN

Pin No.	Definition	Pin No.	Definition
1	5V	10	5V
2	USB_Dn	11	USB_Dn
3	USB_Dp	12	USB_Dp
4	GND	13	GND
5	USB3_RXn	14	USB3_RXn
6	USB3_RXp	15	USB3_RXp
7	GND	16	GND
8	USB3_TXn	17	USB3_TXn
9	USB3_TXp	18	USB3_TXp

## 3.2.9 SODIMM1, SODIMM2 (DDR5 SO-DIMM Slot)

9

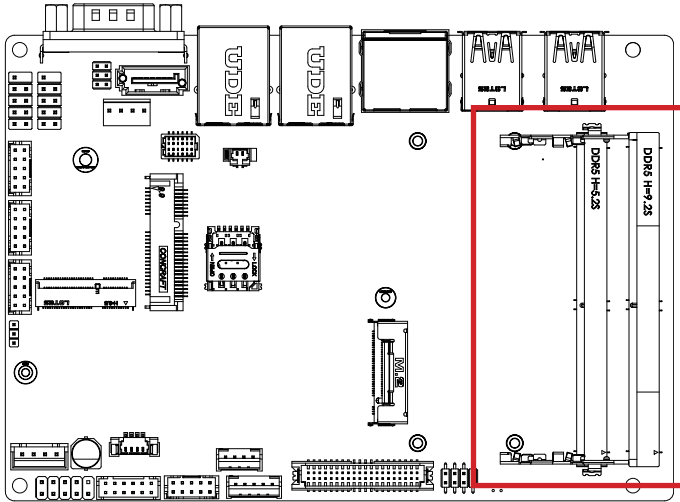

### 3.2.10 LSW (LVDS resolution jumper)

10

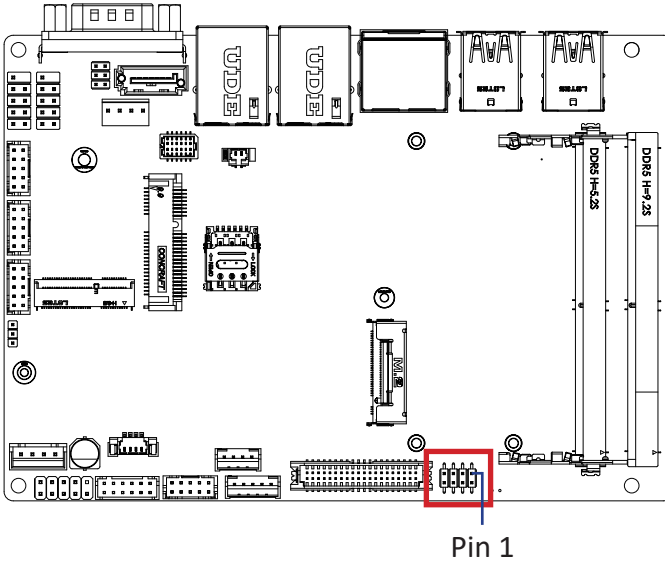

LVDS Resolution Jumper			
Jumper Setting	Resolution	Jumper Setting	Resolution
	800 x 600 18bit		1366 x 768 24bit
	1024 x 768 18bit		1440 x 900 24bit
	1024 x 768 24bit		1400 x 1050 24bit
	1024 x 600 18bit		1600 x 900 24bit
	1280 x 800 18bit		1680 x 1050 24bit
	1280 x 960 18bit		1600 x 1200 24bit
	1280 x 1024 24bit		1920 x 1080 24bit
	1366 x 768 18bit		1920 x 1200 24bit

Connector PN	Vendor
222-97-04GBE1	PINREX

Connector type
2x4pin header, pitch 2.0mm

## 3.2.11 LVDS (LVDS connector)

11

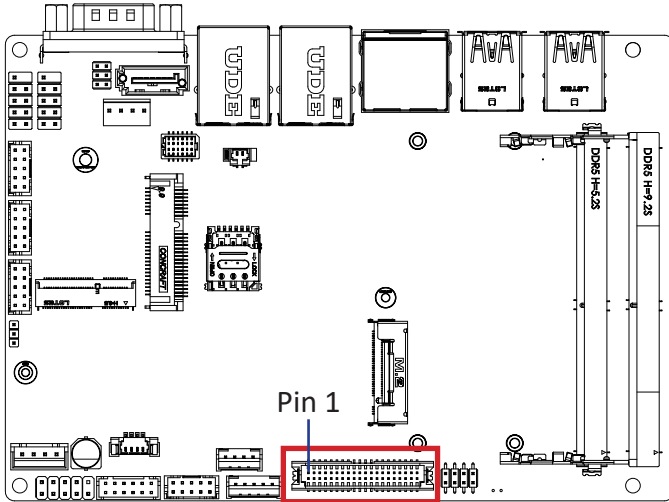

LVDS Connector

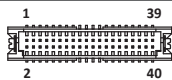

Pin No.	Definition	Pin No.	Definition
1	3.3V	21	A5+
2	5V	22	A4+
3	3.3V	23	A5-
4	5V	24	A4-
5	SPECO	25	GND
6	SPEDO	26	GND
7	GND	27	A7+
8	GND	28	A6+
9	A1+	29	A7-
10	A0+	30	A6-
11	A1-	31	GND
12	A0-	32	GND
13	GND	33	CLK2+
14	GND	34	CLK1+
15	A3+	35	CLK2-
16	A2+	36	CLK1-
17	A3-	37	GND

Pin No.	Definition	Pin No.	Definition
18	A2-	38	GND
19	GND	39	12V
20	GND	40	12V

Connector PN	Vendor
712-76-40GWEO	PINREX
A1252WV-SF-2X20PD01	JOINT-TECH

Connector type
2x20pin header, pitch 1.25mm

For each model support LVDS function.  
But below model no need to add.  
A0~A3 is odd channel 0~3, A4~A7 is even channel.

Note: \*The LVDS output connector of the unit is only intended to be connected to an UL/IEC/EN approval equipment with fire enclosure.

### 3.2.12 BKL\_CN (Backlight control header)

12

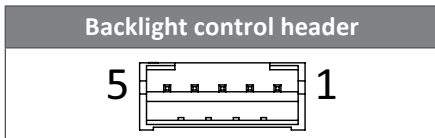
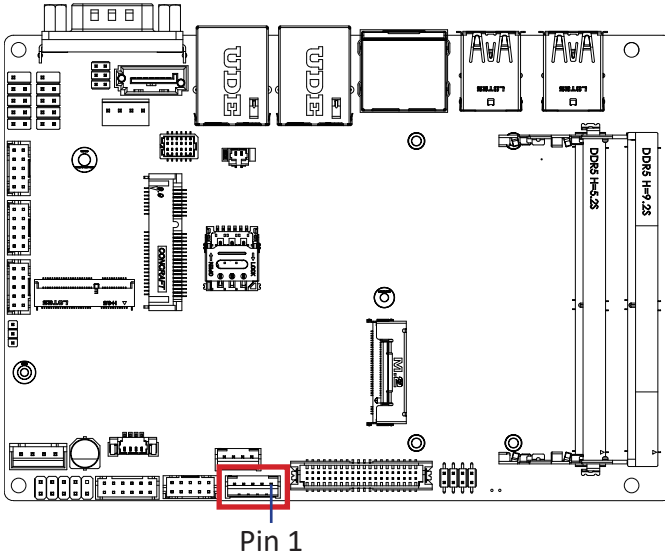

Connector PN	Vendor
721-81-05TW00	PINREX

**Connector type**

1x5pin header, pitch 2.0mm

Pin No.	Definition
1	5V
2	PWM
3	Backlight Enable
4	GND
5	12V

## 3.2.13 SPKR (Speaker out connector)

13

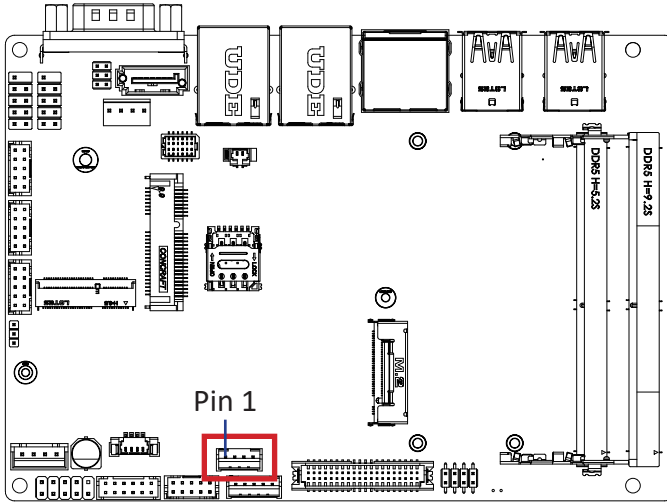

Audio Amplifie Connector

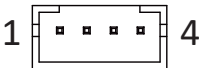

Pin No.	Definition
1	Speaker Out L+
2	Speaker Out L-
3	Speaker Out R-
4	Speaker Out R+

Connector PN

A2001WV-04P146

Vendor

JOINT-TECH

Connector type

1x4pin header, pitch 2.0mm

### 3.2.14 FP\_AUDIO (Front Audio connector)

14

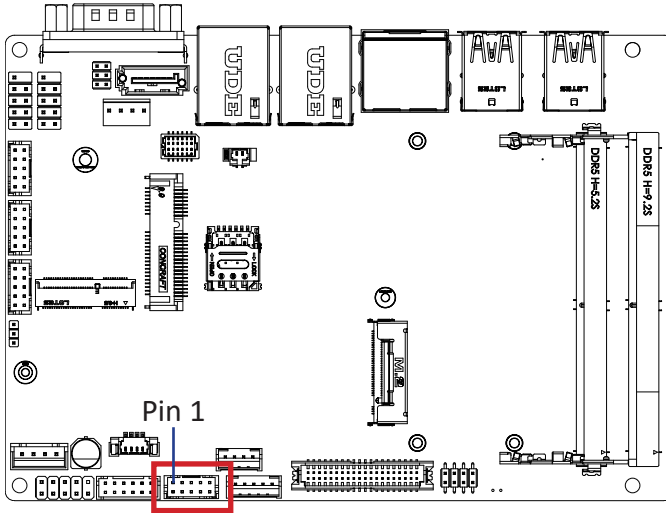

Front Audio Connector	

Pin No.	Definition
1	MIC_Left
2	GND
3	MIC_Right
4	NC
5	LINE_Right
6	MIC_JD
7	Jacksense Detect
8	No Connect
9	LINE_Left
10	GND

Connector PN	Vendor
725-81-10TW00	PINREX

Connector type
2x5pin header, pitch 2.0mm

## 3.2.15 GPIO\_CNT (General Purpose input/output header)

15

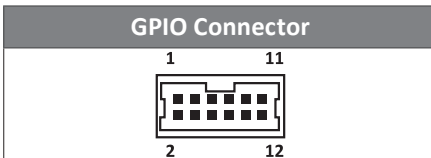
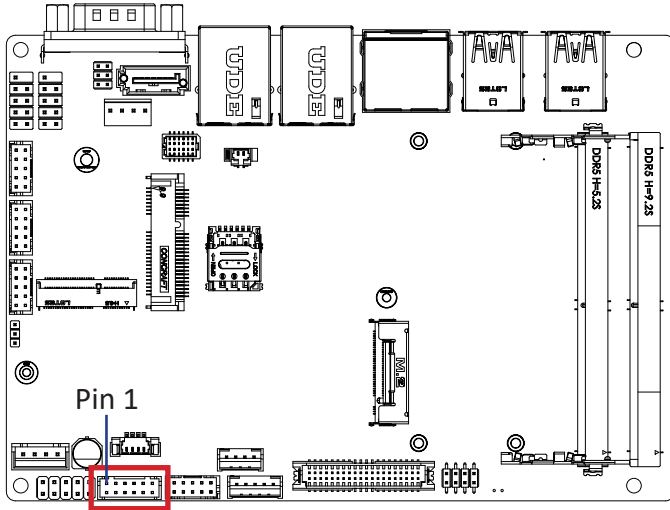

Pin No.	Definition
1	GPIO-output_1
2	GPIO-input_1
3	GPIO-output_2
4	GPIO-input_2
5	GPIO-output_3
6	GPIO-input_3
7	GPIO-output_4
8	GPIO-input_4
9	SMBus Clock

Pin No.	Definition
10	SMB_DATA
11	5V
12	GND

Connector PN	Vendor
725-81-12TW00	PINREX

Connector type
2x6pin header, pitch 2.0mm

### 3.2.16 CAN\_BUS (CANBus header)

16

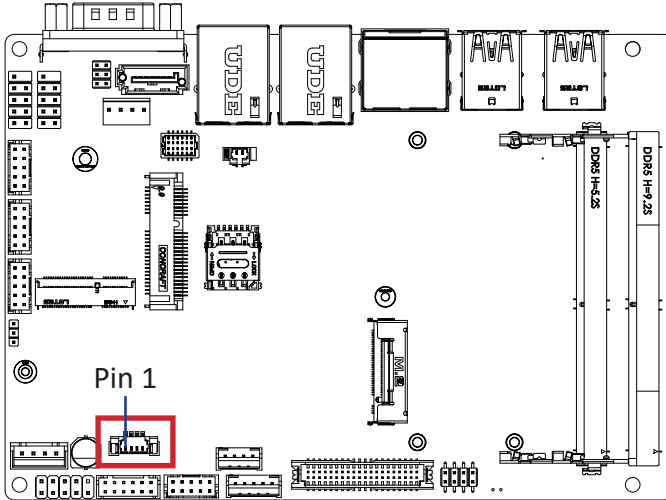

CANBus Header	
1234	
Pin No.	Definition
1	GND
2	CAN_H
3	CAN_L
4	5V

Connector PN	Vendor
85205-0470N	ACES
A1250WV-S-04PC	JOINT-TECH
Connector type	
1x4pin header, pitch 1.25mm	

## 3.2.17 SYS\_PANEL (Front panel header)

17

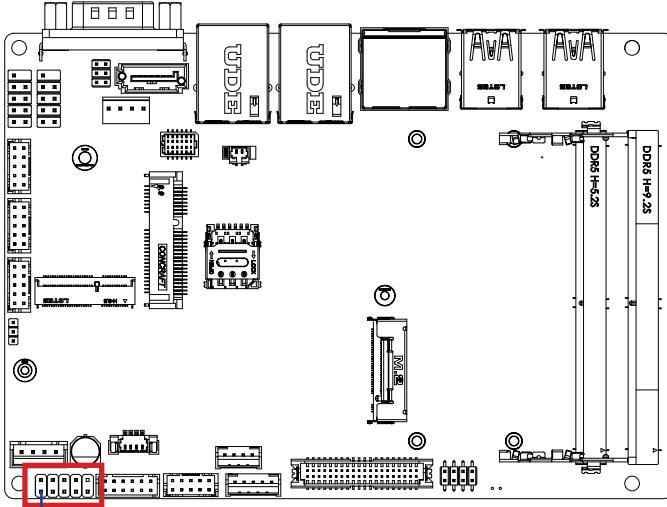

Pin 1

System Panel Header



Pin No.	Definition
1	HDD LED+
2	Power LED+
3	HDD LED-
4	Power LED-
5	GND
6	Power Button+
7	Reset Button
8	Power Button-
9	No Connect
10	No Pin

Connector PN

210-92-05GW5W

Vendor

PINREX

Connector type

2x5pin header, pitch 2.54mm

### 3.2.18 DC\_IN (DC IN 1x4 pin power connector)

18

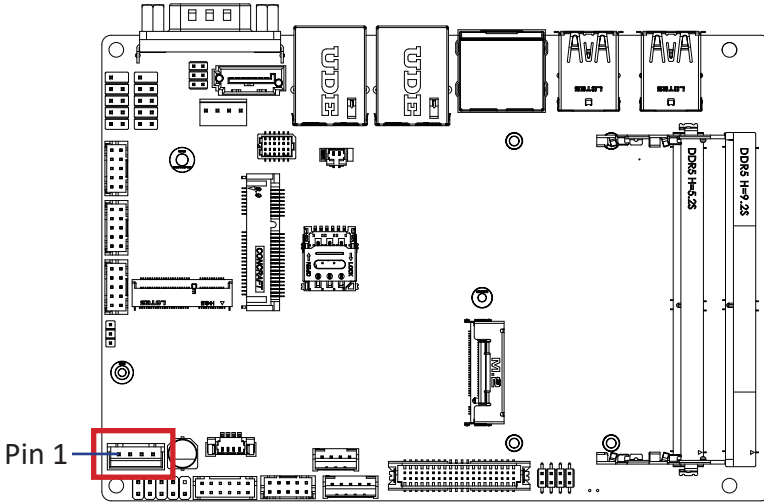

DC IN connector	
 1 2 3 4	
Pin No.	Definition
1	GND
2	Power
3	Power
4	GND

Connector PN	Vendor
753-81-04TW00	PINREX
Connector type	
1x4pin header, pitch 2.5mm	

## 3.2.19 AT\_CN (AT/ATX mode select jumper)

19

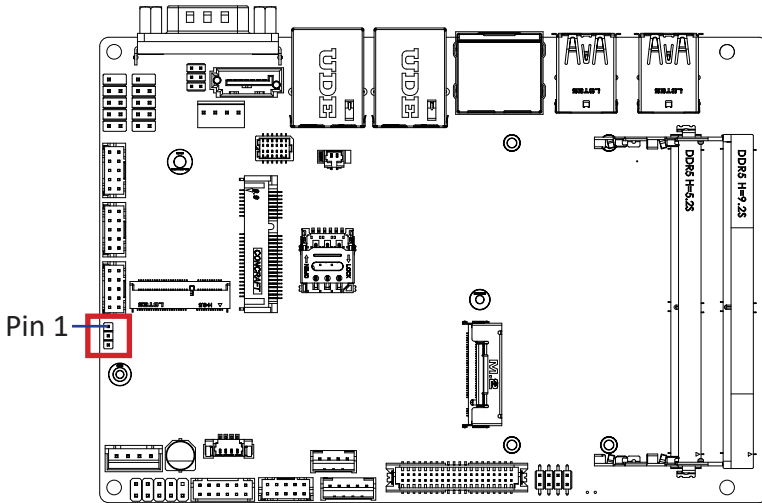

AT/ATX mode select jumper



Pin No.	Definition
1	AT MODE
2	GPO7
3	ATX MODE

Jumper setting  
 1-2 Close : AT mode.  
 2-3 Close : ATX mode.(Default setting)

Connector PN

220-96-03GB001K

A2015WV-03P6T

Vendor

PINREX

JOINT-TECH

Connector type

1x3pin header, pitch 2.0mm

### 3.2.20 COM2, COM3, COM4 (Serial port header, RS-232/422/485)

20

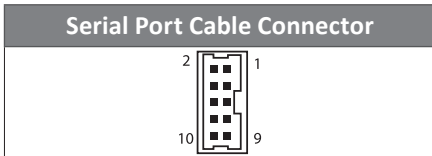
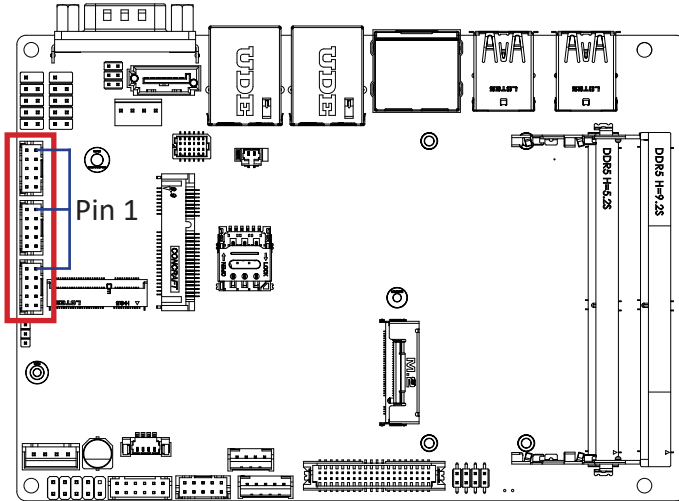

Connector PN	Vendor
725-81-10TW00	PINREX
Connector type	
2x5pin header, pitch 2.0mm	

Pin No.	RS-232	RS-422 Full Duplex	RS-485 Half Duplex
1	RXD	TXD+	D+
2	DCD	TXD-	D-
3	DTR	RXD-	—
4	TXD	RXD+	—
5	DSR	—	—
6	GND	—	—
7	CTS	—	—
8	RTS	—	—
9	No Connect	—	—
10	RI	—	—

## 3.2.21 FUSB1, FUSB2 (USB 2.0 headers)

21

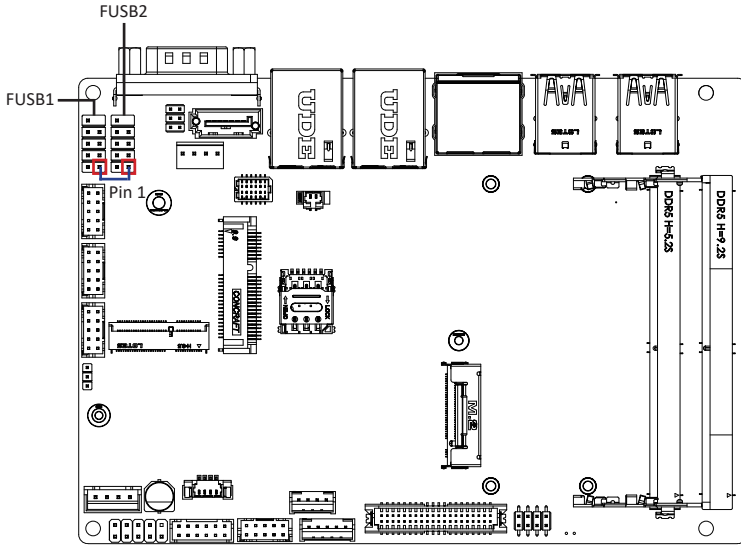

USB 2.0 Header



Connector PN

210-92-05GB04

Vendor

PINREX

PH10R53BAZ009

HORNGTONG

Connector type

2x5pin header, pitch 2.54mm

Pin No.	Definition
1	5V
2	5V
3	DXn
4	DYn
5	DXp
6	DYp
7	GND
8	GND
9	No Pin
10	No Connect

### 3.2.22 JCOM1 (RI# pin RI#/5V/12V Select jumper for COM1 Port)

22

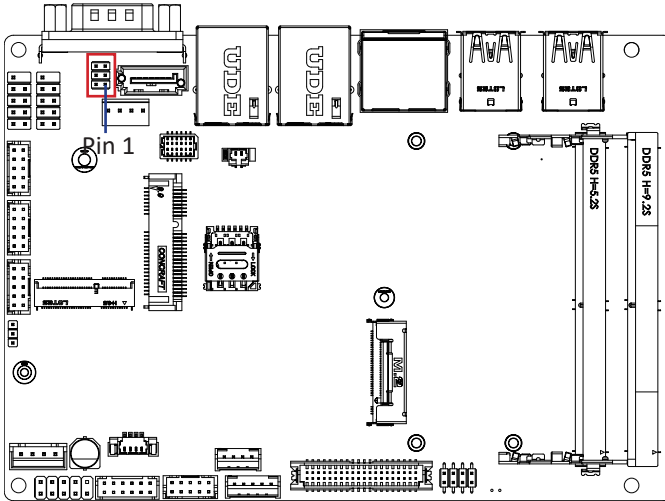

JCOM1 Jumper Select	
	1-2 Close: 5V (Power COM)
	3-4 Close: RI (Stand COM) (Default-Setting)
	5-6 Close: 12V (Power COM)

Connector PN	Vendor
220-97-03GB01	PINREX
PH06N53BAZ000	HORNGTONG
Connector type	
2x3pin header, pitch 2.0mm	

## 3.2.23 SATA0 (SATA 6Gb/s connector)

23

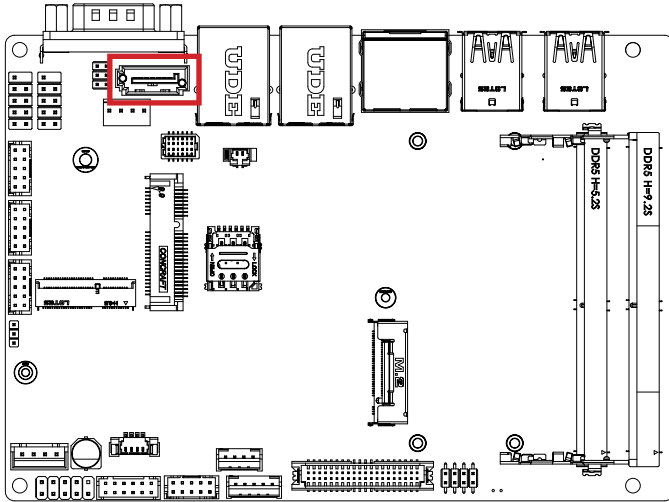

SATA Connector



Connector PN

WATF-07DBLBA1UW

Vendor

WINWIN

Pin No.	Definition
1	GND
2	TXp
3	TXn
4	GND
5	RXn
6	RXp
7	GND

### 3.2.24 SATAPWR (SATA power connector)

24

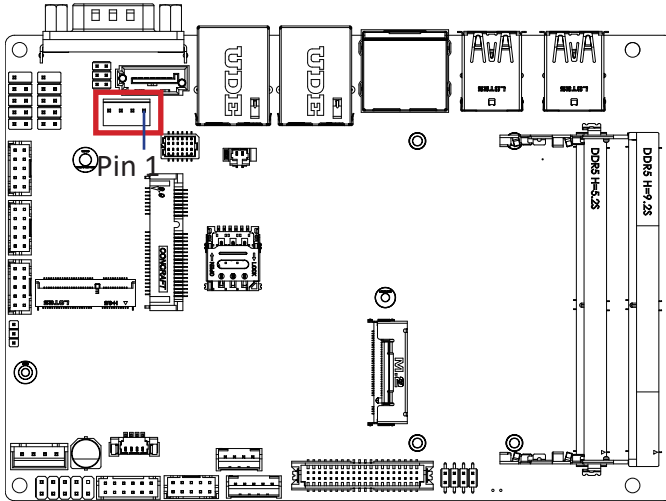

Hard Disk Power Connector	
4  1	
Pin No.	Definition
1	12V
2	GND
3	GND
4	5V

Connector PN	Vendor
743-91-045W00	PINREX
Connector type	
1x4pin header, pitch 2.54mm	

## 3.2.25 M2E (M.2 Slot, 2230 E-key)

25

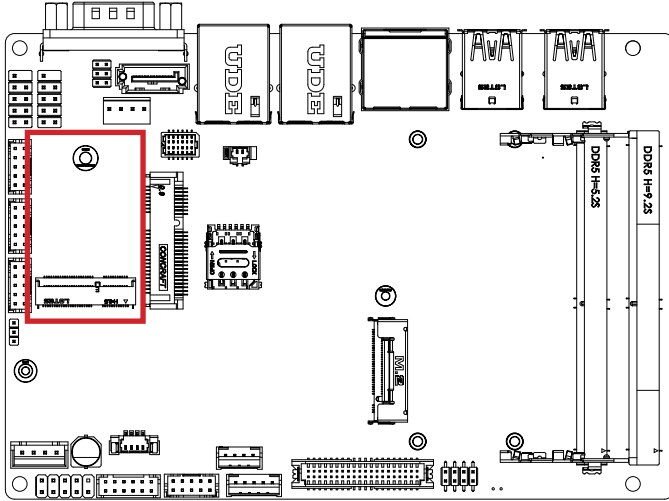

M.2 E Key Connector

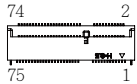

Pin No.	Definition	Pin No.	Definition
1	GND	2	3V
3	USB_Dp	4	3V
5	USB_Dn	6	NC
7	GND	8	NC
9	NC	10	NC
11	NC	12	NC
13	NC	14	NC
15	NC	16	NC
17	NC	18	GND
19	NC	20	NC
21	NC	22	NC
23	NC		

Pin No.	Definition	Pin No.	Definition
33	GND	32	NC
35	WLAN_TXp	34	NC
37	WLAN_TXn	36	NC

39	GND	38	CL_RST#
41	WLAN_RXp	40	CL_DATA
43	WLAN_RXn	42	CL_CLK
45	GND	44	NC
47	CLK_Dp	46	NC
49	CLK_Dn	48	NC
51	GND	50	SUSCLK
53	CLK_REQ	52	PCIE_RST
55	PCIE_WAKE	54	BT_Disable#
57	GND	56	WLAN_DISABLE
59	NC	58	NC
61	NC	60	NC
63	GND	62	NC
65	NC	64	NC
67	NC	66	NC
69	GND	68	NC
71	NC	70	NC
73	NC	72	3V
75	GND	74	3V

Connector PN	Vendor
APCI0095-P002A	LOTES
80152-8521	BELLWETHER

### 3.2.26 MPCIE (Mini PCIe slot)

26

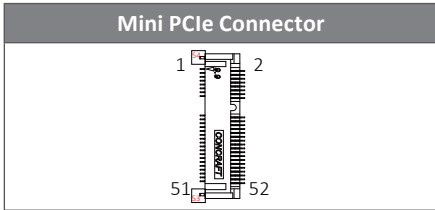
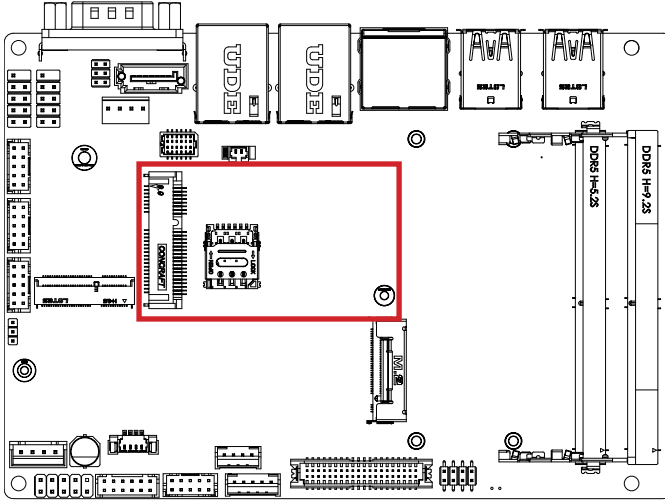

Pin No.	Definition	Pin No.	Definition
1	PCIE WAKE	2	3.3V
3	NC	4	GND
5	NC	6	NC
7	PCIe Clock Request	8	SIM PWR
9	GND	10	SIM DATA
11	PCIe Clock n	12	SIM Clock
13	PCIe Clock p	14	SIM Reset
15	GND	16	UIM VPP3
17	NC	18	GND
19	NC	20	WLAN_DISABLE

Pin No.	Definition	Pin No.	Definition
21	GND	22	Reset
23	PCIe RXn	24	3.3V
25	PCIe RXp	26	GND
27	GND	28	NC
29	GND	30	SMB Clock
31	PCIe TXn	32	SMB DATA
33	PCIe TXp	34	GND
35	GND	36	USB Dn
37	GND	38	USB Dp
39	3.3V	40	GND
41	3.3V	42	NC
43	GND	44	NC
45	NC	46	NC
47	NC	48	NC
49	NC	50	GND
51	NC	52	3.3V

Connector PN	Vendor
AS0B221-S99Q-7H	FOXCONN

## 3.2.27 BATTERY (Battery cable Connector)

27

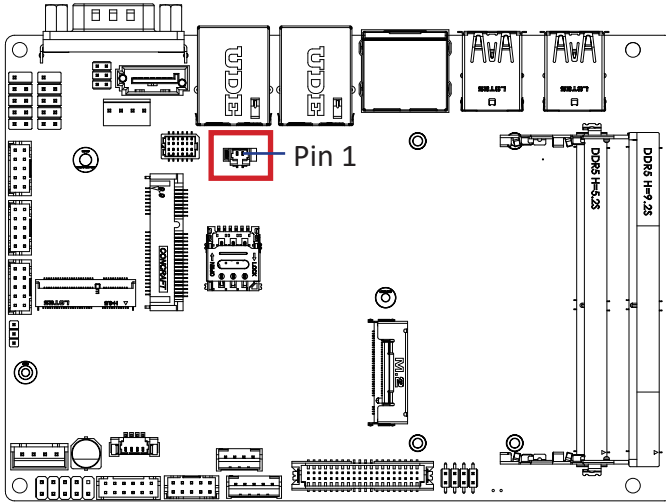

**Battery cable Connector**



Pin No.	Definition
1	3.3V
2	GND

**Connector PN**

85205-0270L

A1250WV-S-02PC

**Vendor**

ACES

JOINT-TECH

**Connector type**

1x2pin header, pitch 1.25mm

## 3.2.28 M2M (M.2 Slot, 2280 M-key)

28

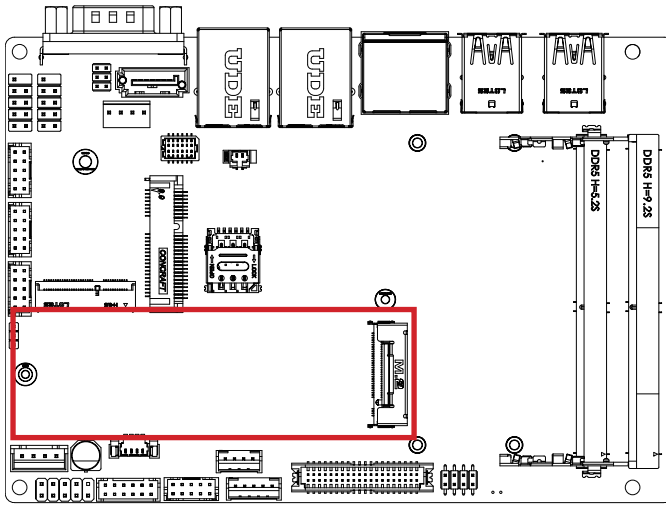

M.2 M Key Connector

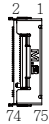

Pin No.	Definition	Pin No.	Definition
1	GND	2	3.3V
3	GND	4	3.3V
5	PCIE_RXn3	6	NC
7	PCIE_RXp3	8	NC
9	GND	10	M2_LED
11	PCIE_TXn3	12	3.3V
13	PCIE_TXp3	14	3.3V
15	GND	16	3.3V
17	PCIE_RXn2	18	3.3V
19	PCIE_RXp2	20	NC
21	GND	22	NC
23	PCIE_TXn2	24	NC
25	PCIE_TXp2	26	NC
27	GND	28	NC
29	PCIE_RXn1	30	NC
31	PCIE_RXp1	32	NC

Pin No.	Definition	Pin No.	Definition
33	GND	34	NC
35	PCIE_TXn1	36	NC
37	PCIE_TXp1	38	DEVS LP
39	GND	40	SMB Clock
41	SATA_RXp	42	SMB DATA
43	SATA_RXn	44	SMB ALERT
45	GND	46	NC
47	SATA_TXn	48	NC
49	SATA_TXp	50	PLT_RST
51	GND	52	CK_REQ
53	CLK_n	54	PCIE_WAKE#
55	CLK_p	56	NC
57	GND	58	NC

Pin No.	Definition	Pin No.	Definition
67	NC	68	SUSCLK
69	M2_SSD_Detect	70	3.3V
71	GND	72	3.3V
73	GND	74	3.3V
75	GND		

Connector PN	Vendor
2E0BC41-C85CM-LH	FOXCONN

# Chapter 4

---

## Chapter 4 – BIOS

## 4.1 Introduction

BIOS (Basic input/output system) provides hardware detailed information and boot-up options, which include firmware to control, set-up and test all hardware settings. Therefore, BIOS is the communication bridge between OS/application software and hardware.

### 4.1.1 How to Entering into BIOS menu

Once the system is power on, press the <DEL> key as soon as possible to access into BIOS Setup program.

### 4.1.2 Function Keys to setup in BIOS Setup program

Function keys	Description
→←	Select Screen
↑↓	Select Item
Enter	Execute command or enter the submenu
+	Increase the numeric value or make changes
—	Decrease the numeric value or make changes
F1	General Help
F2	Previous Values
F3	Load Optimized Defaults Settings
F4	Save changes & Exit the BIOS Setup program
ESC	Exit the BIOS Setup program

## 4.2 The Main Menu

The main menu shows the basic system information. Use arrow keys to move among the items.

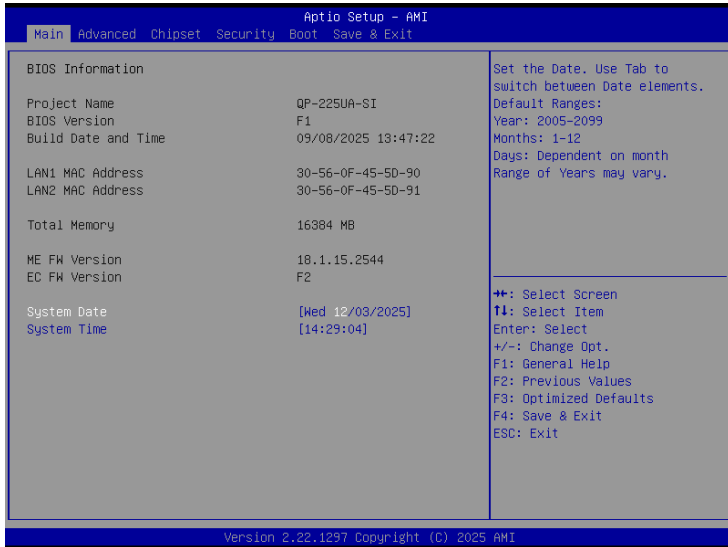

Items	Description
Project Name	Shows Project name information
BIOS Version	Shows the BIOS version of the system
Build Date and Time	Shows the Build Date and Time when the BIOS was created.
LAN1 MAC Address	Shows LAN1 MAC Address information
LAN2 MAC Address	Shows LAN2 MAC Address information
Total Memory	Shows the total memory size of the installed memory
ME FW version	Shows ME firmware version
EC FW version	Shows EC firmware version
System Date	Set the Date for the system (Format : Week - Month - Day - Year)
System Time	Set the time for the system (Format : Hour - Minute - Second)

## 4.3 Advanced

The Advanced menu is to configure the functions of hardware settings through submenu. Use arrow keys to move among the items, and press <Enter> to access into the related submenu.

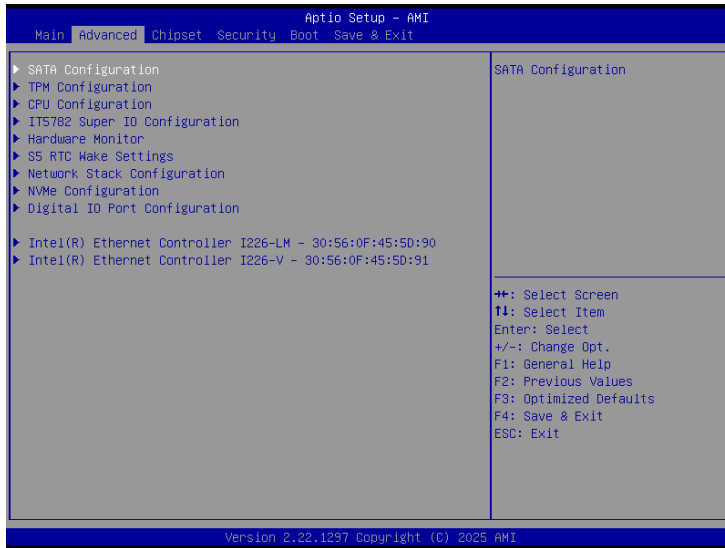

## 4.3.1 SATA Configuration

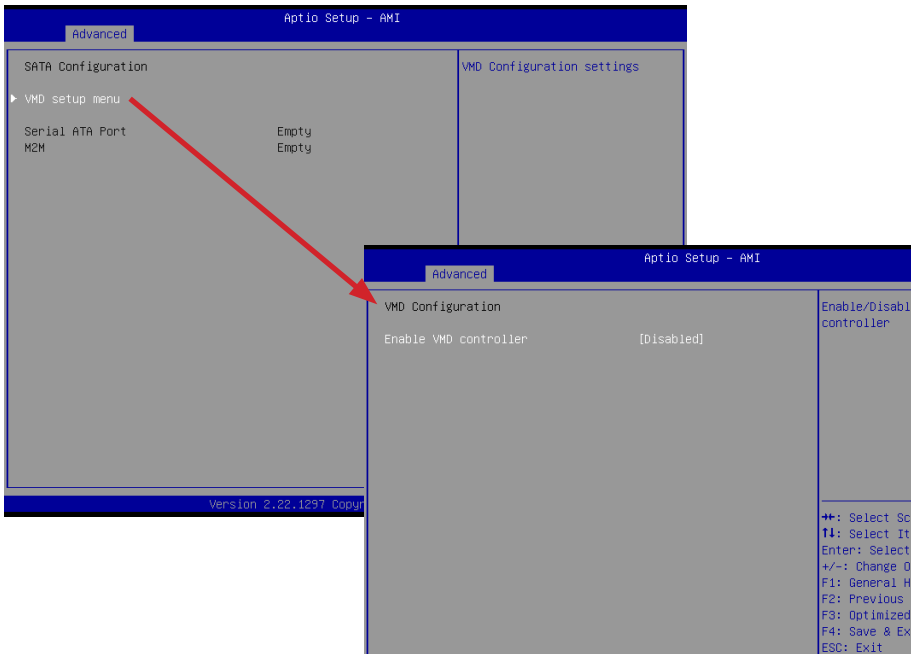

Item	Description
<b>VMD setup menu / Enable VMD controller</b>	Intel VMD feature helps you to control and manage NVMe PCIe SSD. <b>Enabled : Enables Intel VMD feature</b> <b>Disabled : Disables Intel VMD feature (Default setting)</b>
<b>Serial ATA Port</b>	shows 2.5" SATA HDD/SSD information
<b>M2M</b>	shows M.2 SATA interface SSD information

## 4.3.2 TPM Configuration

Use TPM Configuration submenu to choose TPM interface.

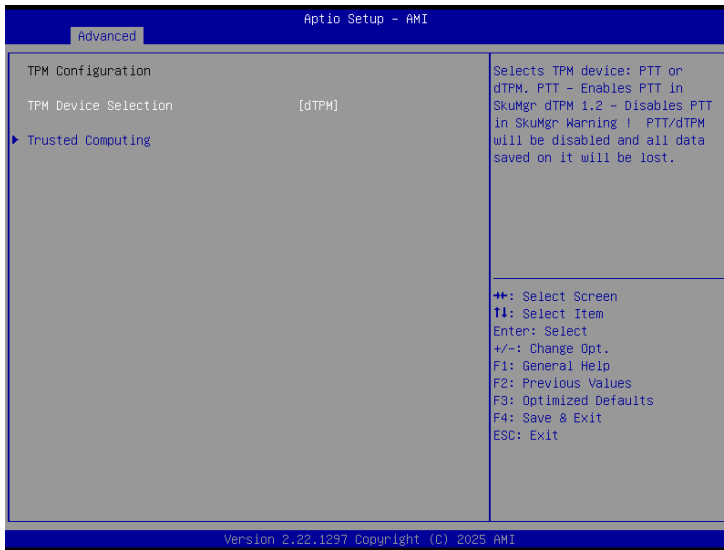

Item	Description
TPM Device Selection	<b>PTT : Internal TPM</b> <b>dTPM : External TPM (When using External TPM module or having TPM chip on MB)(Default setting)</b>

Trusted Computing : Shows TPM information, and TPM module configuration setting.



Item	Description
<b>Security Device support</b>	<b>Enabled :</b> Enables TPM feature (Default setting) <b>Disabled :</b> Disables TPM feature
<b>Pending operation</b>	<b>None :</b> No execution will be conducted (Default setting) <b>TPM clear :</b> Set to clear data on TPM
<b>PH Randomization</b>	<b>Enabled :</b> Enables Platform Hierarchy (PH) Randomization. (Default setting) <b>Disabled :</b> Disables Platform Hierarchy (PH)Randomization.

### 4.3.3 CPU Configuration

This submenu shows detailed CPU informations.

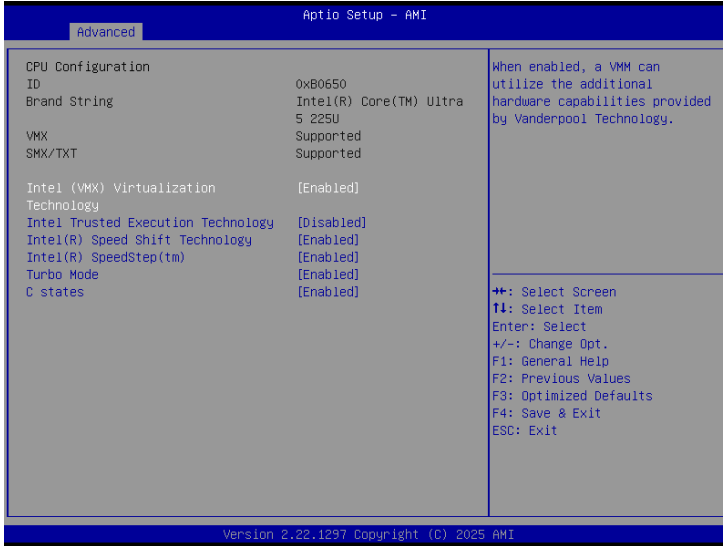

Item	Description
<b>Intel (VMX) Virtualization Technology</b>	Virtualization enhanced by Intel® Virtualization Technology will allow a platform to run multiple operating systems and applications in independent partitions. With virtualization, one computer system can function as multiple virtual systems. <b>Enabled : Enables Intel Virtualization Technology (Default setting)</b> <b>Disabled : Disables Intel Virtualization Technology</b>
<b>Intel Trusted Execution Technology</b>	<b>Disabled : Disables Intel Trusted Execution Technology (Intel® TXT) (Default setting)</b> <b>Enabled : Enables Intel Trusted Execution Technology (Intel® TXT)</b>
<b>Intel(R) Speed Shift Technology</b>	To speed up CPU frequency transition time from basic frequency to maximum frequency. <b>Enabled : Enables Intel(R) Speed Shift Technology Interrupt control (Default setting)</b> <b>Disabled : Disables Intel(R) Speed Shift Technology Interrupt control</b>

<b>Intel(R) SpeedStep(tm)</b>	According to Intel CPU loading, Intel SpeedStep Technology will automatically adjust the CPU voltage and core frequency to decrease heat and power consumption for power saving. <b>Enabled : Enables Intel SpeedStep Technology (Default setting)</b> <b>Disabled : Disables Intel SpeedStep Technology</b>
<b>Turbo Mode</b>	<b>Enabled : Enables Turbo Mode (Default setting)</b> <b>Disabled : Disables Turbo Mode</b>
<b>C states</b>	Command CPU to enter into low power consumption mode when CPU is under idle mode. <b>Enabled : Enables C states (Default setting)</b> <b>Disabled : Disables C states</b>

### 4.3.4 IT5782 Super IO Configuration

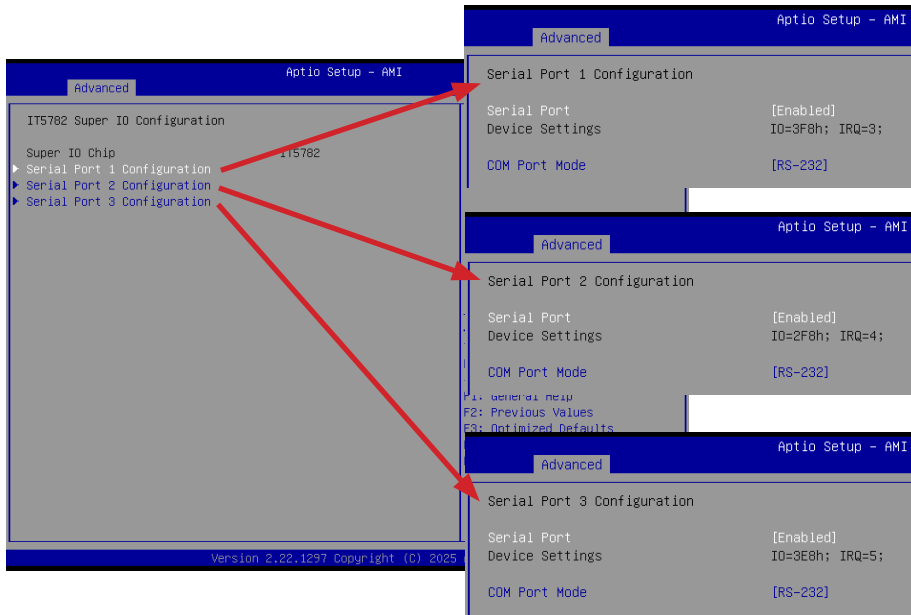

Item	Description
<b>Serial Port 1 Configuration</b>	Press [Enter] to configure advanced items : Serial Port :
<b>Serial Port 2 Configuration</b>	<b>Enabled : Enables allows you to configure the serial port settings</b> <b>Disabled : if Disabled, displays no configuration for the serial port</b> Device settings : Display the specified Serial Port base I/O address and IRQ
<b>Serial Port 3 Configuration</b>	COM Port Mode : Choose RS-232, RS-422, or RS-485 feature

## 4.3.5 Hardware Monitor

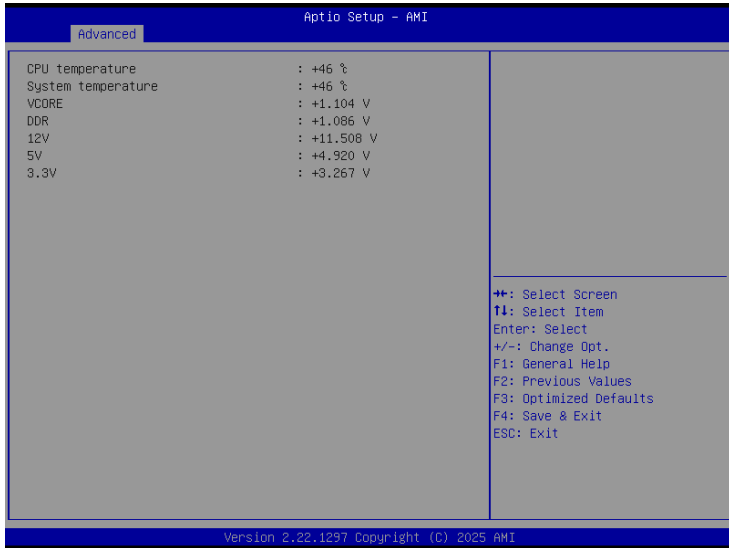

Item	Description
<b>CPU Temperature</b>	Shows current CPU temperature
<b>System Temperature</b>	Shows current system temperature

### 4.3.6 S5 RTC Wake Settings



Item	Description
<b>Wake system from S5</b>	Enable or Disable System to wake on a specific time. <b>Disabled : Disables system to wake on a specific time (Default setting)</b> <b>Fixed Time : Enables system to wake on a specific time (Format : hr : min : sec)</b>

### 4.3.7 Network Stack Configuration

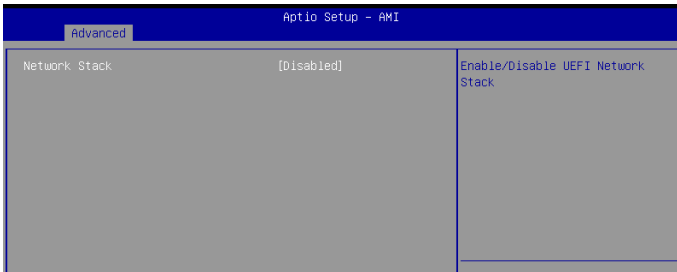

When Network stack is enabled :

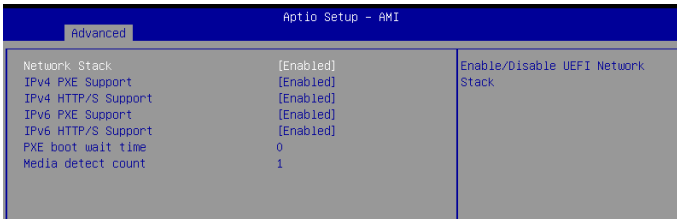

Item	Description
<b>Network Stack</b>	When system is power on, install LAN driver under UEFI mode <b>Disabled : Disables UEFI Network Stack (Default setting)</b> <b>Enabled : Enables UEFI Network Stack</b>
<b>IPv4 PXE Support</b>	When Network stack is enabled : <b>Disabled : Disables IPv4 PXE Support</b> <b>Enabled : Enables IPv4 PXE Support</b>
<b>IPv4 HTTP/S Support</b>	When Network stack is enabled : <b>Disabled : Disables IPv4 HTTP/S Support</b> <b>Enabled : Enables IPv4 HTTP/S Support</b>
<b>IPv6 PXE Support</b>	When Network stack is enabled : <b>Disabled : Disables IPv6 PXE Support</b> <b>Enabled : Enables IPv6 PXE Support</b>
<b>IPv6 HTTP/S Support</b>	When Network stack is enabled : <b>Disabled : Disables IPv6 HTTP/S Support</b> <b>Enabled : Enables IPv6 HTTP/S Support</b>
<b>PXE boot wait time</b>	Wait time in seconds, or use ESC key to abort the PXE boot.
<b>Media detect count</b>	Number of times the presence of media will be checked.

### 4.3.8 NVMe Configuration

NVMe Configuration shows information when your M.2 NVMe PCIe SSD is installed.



### 4.3.9 Digital IO Port Configuration

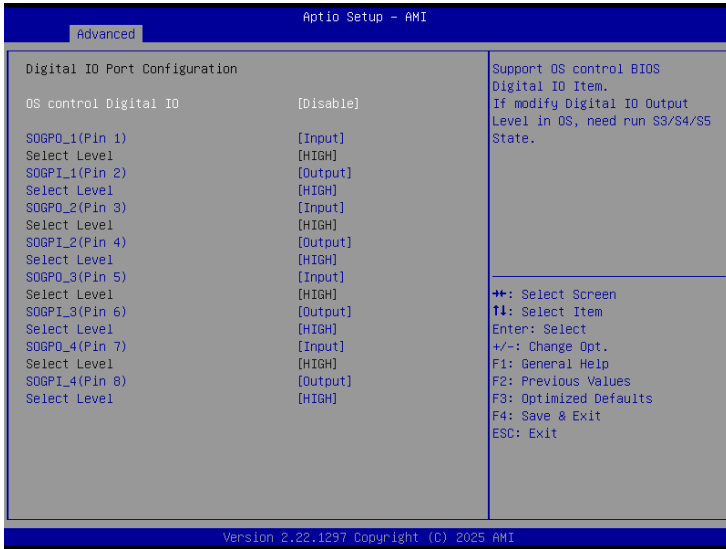

Item	Description
OS control Digital IO	Disabled : If Digital IO Output value/level is modified in OS, they will not be memorized and kept. (Default setting) Enabled : If Digital IO Output value/level is modified in OS, they will be memorized and kept.
SOGPO_1 (Pin 1) SOGPI_1 (Pin 2) SOGPO_2 (Pin 3) SOGPI_2 (Pin 4) SOGPO_3 (Pin 5) SOGPI_3 (Pin 6) SOGPO_4 (Pin 7) SOGPI_4 (Pin 8)	Configure Digital IO Input or Output values for each pin.

### 4.3.10 Intel(R) Ethernet Controller I226-LM - 30:56:0F:45:5D:90 (MAC address may varied based on different motherboard)

Shows Intel Ethernet controller information

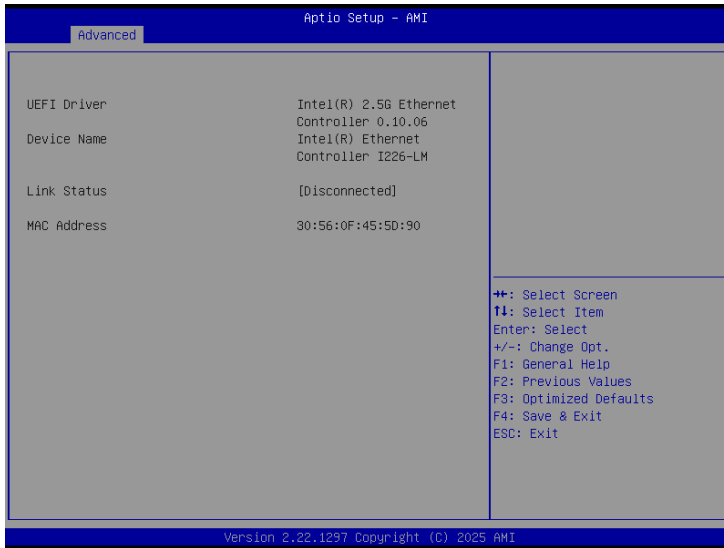

## 4.3.11 Intel(R) Ethernet Controller I226-V - 30:56:0F:45:5D:91 (MAC address may varied based on different motherboard)

Shows Intel Ethernet controller information

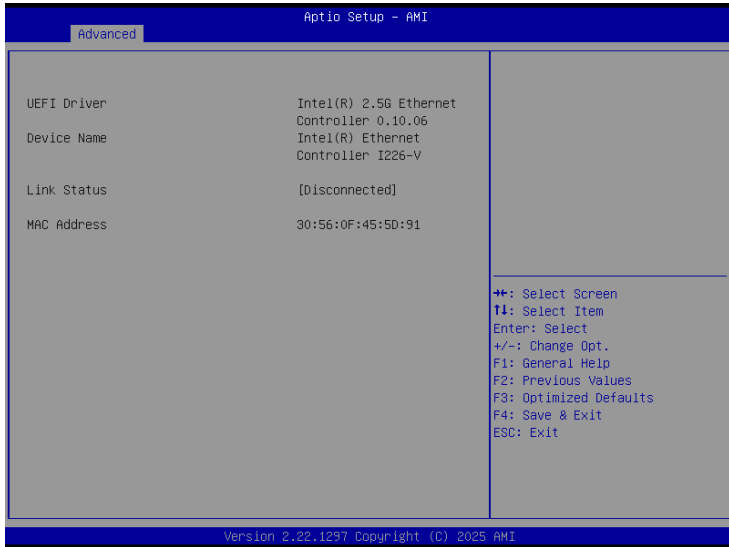

## 4.4 Chipset

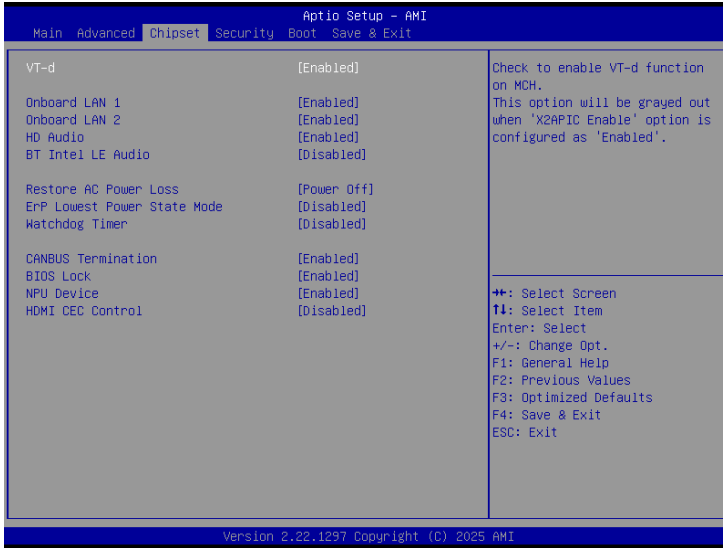

Item	Description
<b>VT-d</b>	<b>Enabled : Enables VT-d function (Default setting)</b> <b>Disabled : Disables VT-d function</b>
<b>Onboard LAN1</b> <b>Onboard LAN2</b>	Enable/Disable onboard LAN controller <b>Enabled : Enables onboard LAN controller (Default setting)</b> <b>Disabled : Disables onboard LAN controller</b>
<b>HD Audio</b>	Enable/Disable onboard audio controller <b>Enabled : Enables onboard audio controller (Default setting)</b> <b>Disabled : Disables onboard audio controller</b>
<b>BT Intel LE Audio</b>	Enable/Disable BT Intel LE Audio function <b>Enabled : Enables BT Intel LE Audio function</b> <b>Disabled : Disables BT Intel LE Audio function (Default setting)</b>
<b>Restore AC Power Loss</b>	To set which option the system should returns if a sudden power loss occurred <b>Power on : System power on when the power is back</b> <b>Power off : Do not power on when the power is back (Default setting)</b> <b>Last state : Restore the system to the state before power loss occurs</b>

<b>ErP Lowest Power State Mode</b>	<p>Enable/Disable power saving funtion</p> <p><b>Enabled : Enables ERP Lowest Power State Mode</b></p> <p><b>Disabled : Disabled ERP Lowest Power State Mode (Default setting)</b></p>
<b>Watchdog Timer</b>	<p>Enable/Disable Watchdog Timer function</p> <p><b>Enabled : Enables Watchdog Timer function</b></p> <p><b>Disabled : Disabled Watchdog Timer function (Default setting)</b></p>
<b>CANBUS Termination</b>	<p>Enable/Disable CANBUS Termination function</p> <p><b>Enabled : Enables CANBUS Termination function (Default setting)</b></p> <p><b>Disabled : Disabled CANBUS Termination funtion</b></p>
<b>BIOS Lock</b>	<p>Enable/Disable BIOS Lock function</p> <p><b>Enabled : Enables BIOS Lock function (Default setting)</b></p> <p><b>Disabled : Disabled BIOS Lock funtion</b></p>
<b>NPU Device</b>	<p>Enable/Disable NPU Device function</p> <p><b>Enabled : Enables NPU Device function (Default setting)</b></p> <p><b>Disabled : Disabled NPU Device funtion</b></p> <p>※Suggest to disable this function when using Windows 10</p>
<b>HDMI CEC Control</b>	<p>Enable/Disable HDMI CEC Control function</p> <p><b>Enabled : Enables HDMI CEC Control function</b></p> <p><b>Disabled : Disabled HDMI CEC Control funtion (Default setting)</b></p>

## 4.5 Security



Item	Description
<b>Administrator Password</b>	To set up Administrator's password <b>Minimum length : 3</b> <b>Maximum length : 20</b>
<b>User Password</b>	To set up User's password <b>Minimum length : 3</b> <b>Maximum length : 20</b>
<b>Secure Boot</b>	Press <Enter> to configure the advanced items



Item	Description
<b>Secure Boot</b>	Secure Boot requires all the applications that are running during the booting process to be pre-signed with valid digital certificates <b>Enabled : Enables Secure Boot function</b> <b>Disabled : Disables Secure Boot function (Default setting)</b>
<b>Secure Boot Mode</b>	<b>Standard : Standard mode</b> <b>Custom : Custom mode (Default setting)</b>
<b>Restore Factory Keys</b>	To restore factory settings <b>Yes : Agree to restore factory settings</b> <b>No : Cancel to restore factory settings</b>
<b>Reset To Setup Mode</b>	<b>Yes : Agree to setup mode</b> <b>No : Cancel to setup mode</b>
<b>Key Management</b>	Enables expert users to modify Secure boot policy variables without full authentication Press <Enter> to configure the advanced items

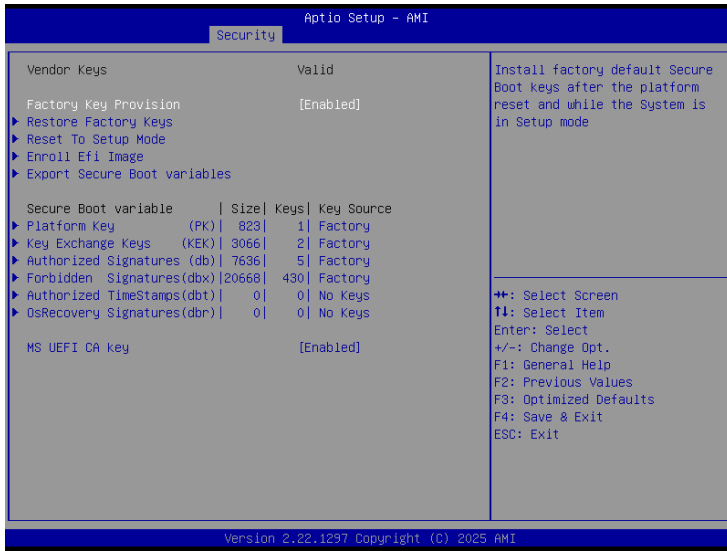

Item	Description	Item	Description			
<b>Factory Key Provision</b>	Install factory default Secure Boot keys after the platform reset and while the system is in Setup mode <b>Enabled : Enables Factory Key Provision (Default setting)</b> <b>Disabled : Disables Factory Key Provision</b>	<b>Platform Key (PK)</b>	These items allows you to enroll factory defaults or load Certificates from a file.			
	<b>Restore Factory Keys</b>	To restore factory settings <b>Yes : Agree to restore factory settings</b> <b>No : Cancel to restore factory settings</b>		<b>Key Exchange Keys (KEK)</b>		
		<b>Reset To Setup Mode</b>		<b>Yes : Agree to setup mode</b> <b>No : Cancel to setup mode</b>	<b>Authorized Signatures (db)</b>	
				<b>Enroll Efi Image</b>	Allow the image to run in Secure Boot mode	<b>Forbidden Signatures (dbx)</b>
					<b>Export Secure Boot variables</b>	Copy NVRAM content of Secure Boot variables to files in a root folder on a file system device
		<b>OsRecovery Signatures (dbr)</b>				
		<b>MS UEFI CA Key</b>	Device Guard ready system must not list 'Microsoft UEFI CA' Certificate in Authorized Signature database(db)			

## 4.6 Boot

This Boot menu allows you to set/change system boot options

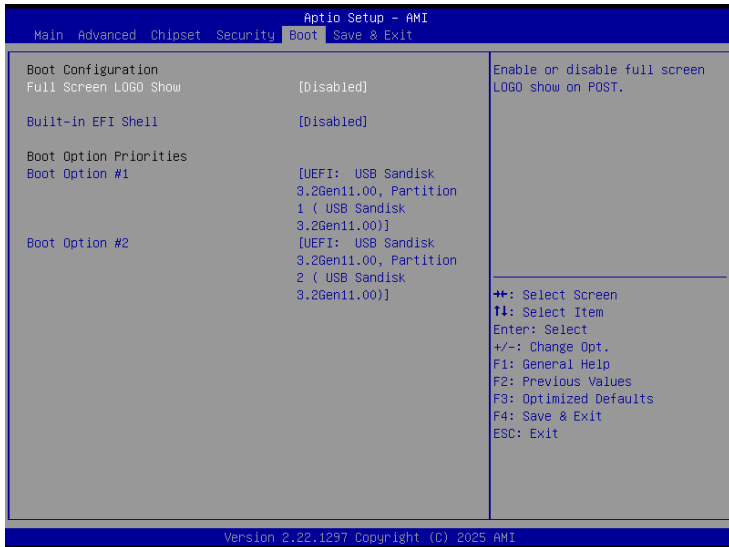

Item	Description
<b>Full Screen LOGO Show</b>	Enable/Disable full screen LOGO show on POST screen <b>Enabled : Enables Full screen LOGO Show on POST screen</b> <b>Disabled : Disables Full screen LOGO Show on POST screen (Default setting)</b>
<b>Built-in EFI shell</b>	Enable/Disable Built-in EFI Shell <b>Enabled : Enables Built-in EFI Shell</b> <b>Disabled : Disables Built-in EFI Shell (Default setting)</b>
<b>Boot Option #1</b> <b>Boot Option #2</b>	Shows the information of the storage that be installed in the system <b>Choose/set the boot priority</b>

## 4.7 Save & Exit

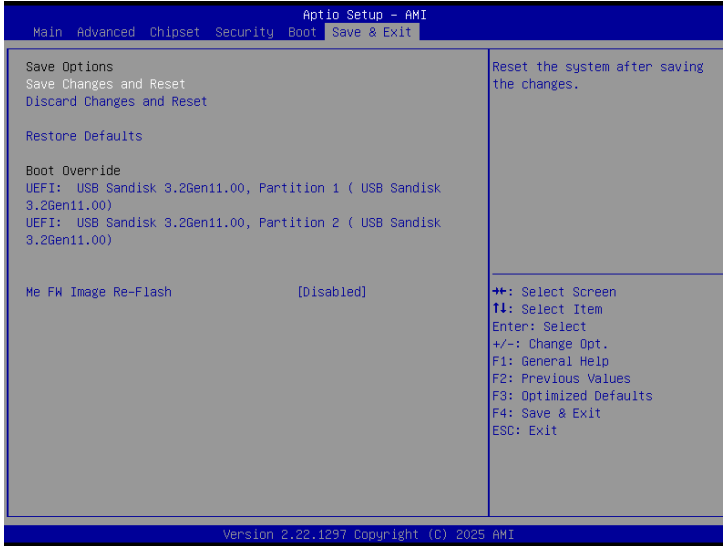

Item	Description
<b>Save Changes and Reset</b>	After configuring all the options that you wish to change, choose this option to save all the changes and reboot the system <b>Yes : Agree to save and reset</b> <b>No : Cancel to save and reset</b>
<b>Discard Changes and Reset</b>	Choose this option to reboot the system without saving any changes <b>Yes : Agree to discard changes and reset</b> <b>No : Cancel to discard changes and reset</b>
<b>Restore Defaults</b>	Restore/Load default values for all the setup options <b>Yes : Agree to load optimized defaults</b> <b>No : Cancel to load optimized defaults</b>
<b>Me FW Image Re-Flash</b>	Enable/Disable Me FW image re-flash function <b>Enabled : Enables Me FW image re-flash function</b> <b>Disabled : Disables Me FW image re-flash function (Default setting)</b>