



**Introduction**

ORing's Transporter™ series un-managed Ethernet switches are designed for industrial applications, such as rolling stock, vehicle, and railway applications. The **TES-W180-M12-WV-IP67** is an un-managed Ethernet switch with 8x10/100Base-T(X) which is specifically designed for the toughest and fully compliant with EN50155 requirement. **TES-W180-M12-WV-IP67** EN50155 Ethernet switch use M12 connectors to ensure tight, robust connections, and guarantee reliable operation against environmental disturbances, such as vibration and shock. In addition, the wide operating temperature range from -40°C to 75°C can satisfy most of operating environment. The **TES-W180-M12-WV-IP67** can be easily adopted in all kinds of applications and provides the most rugged solutions for your network. Therefore, the switch is one of the most reliable choices for rolling stock Ethernet application.

**Package Contents**





The device is shipped with the following items. If any of these items is missing or damaged, please contact your customer service representative for assistance.

Contents	Pictures	Number
TES-W180-M12-WV-IP67		1
Flat Screw (#8-15 L36)		4
QIG		1

**Preparation**

Before you begin installing the device, make sure you have all of the package contents available.

**Safety & Warnings**

-  **Elevated Operating Ambient:** If installed in a closed environment, make sure the operating ambient temperature is compatible with the maximum ambient temperature (T<sub>ma</sub>) specified by the manufacturer.
-  **Reduced Air Flow:** Make sure the amount of air flow required for safe operation of the equipment is not compromised during installation.
-  **Mechanical Loading:** Make sure the mounting of the equipment is not in a hazardous condition due to uneven mechanical loading.
-  **Circuit Overloading:** Consideration should be given to the connection of the equipment to the supply circuit and the effect that overloading of the circuits might have on overcurrent protection and supply wiring. Appropriate consideration of equipment nameplate ratings should be used when addressing this concern.

**Dimension** Unit =mm (Tolerance ±0.5mm)

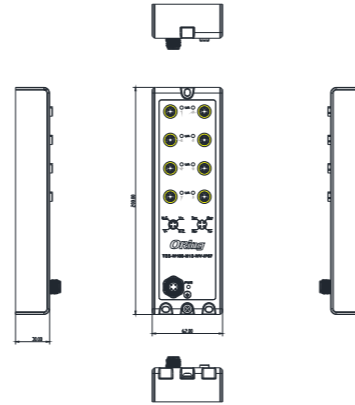

**Panel Layouts**

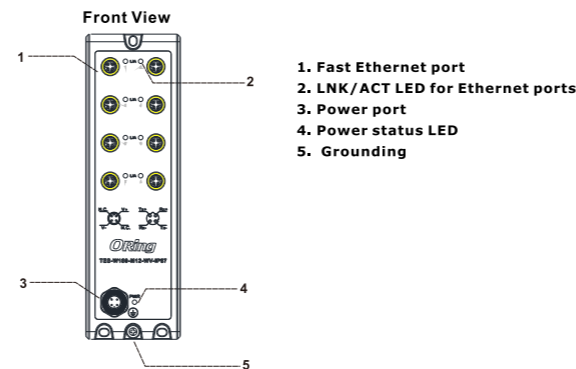

**Installation**

**Wall-mount**

The device can be fixed to the wall. Follow the steps below to install the device on the wall.  
**Step 1:** Hold the device upright against the wall  
**Step 2:** Insert three screws (marked 1, 2, 3 on the diagram) through the large opening of the keyhole-shaped apertures at the top and bottom of the unit and fasten the screw to the wall with a screwdriver.  
**Step 3:** Slide the device downwards and tighten the four screws for added stability.

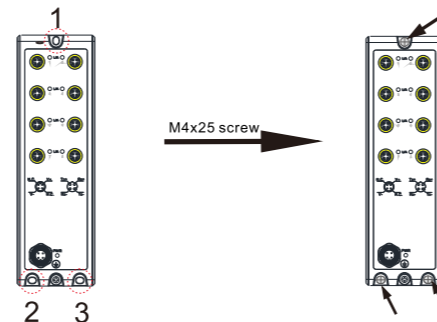

**Wiring**

For pin assignments of power port, please refer to the following tables.

**Grounding**

Grounding and wire routing help limit the effects of noise due to electromagnetic interference (EMI). Run the ground connection from the grounding pin on the power connector to the grounding surface prior to connecting devices, and please use the green-and-yellow cable type minimum with American Wire Gauge (AWG) 18 for grounding.

NOTE: Equipment intended for installation in Restricted Access Location, only for Instructed person to install and maintenance.

**Power port pinouts**

The switch provides one set of power supply on a M12 4-pin A-coding connector. Insert the power cable to the power connector on the device and rotate the outer ring of the cable connector until a snug fit is achieved. Make sure the connection is tight.

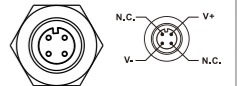

**Network Connection**

The switch has eight 10/100Base-T(X) Ethernet ports in the form of M12 connector. Depending on the link type, the switch uses CAT 3, 4, 5, 5e UTP cables to connect to network devices (PCs, servers, switches, routers, or hubs). Please refer to the following table for cable specifications.

Cable	Type	Max. Length	Connector
10BASE-T	Cat. 3, 4, 5 100-ohm	UTP 100 m (328 ft)	M12 D-coding connector
100BASE-TX	Cat. 5 100-ohm UTP	UTP 100 m (328 ft)	M12 D-coding connector

**Pin Definition**

M12 D-coding Pin Definition	
Pin No.	Description
#1	TX+
#2	RX+
#3	TX-
#4	RX-



**Configurations**

After installing the switch and connecting cables, start the device by turning on power. The green power LED should turn on. Please refer to the following table for LED indication.

LED	Color	Status	Description
PWR	Green	On	Power is enabled
10/100 Base-T(X) Ethernet ports Link/Act indicators			
10/100Mbps (Upper LED)	Green	On	Port is running at 10/100 Mbps
		Off	Port is link-down
		Blinking	Data transmitted

## Specifications

<b>ORing Switch Model</b>	<b>TES-W180-M12-WV-IP67</b>
<b>Physical Ports</b>	
10/100 Base-T(X) Ports in M12 Auto MDI/MDIX	<b>8 (4-pin female D-coding)</b>
<b>Technology</b>	
Ethernet Standards	IEEE 802.3 for 10Base-T IEEE 802.3u for 100Base-TX IEEE 802.3x for Flow control
MAC Table	2k
Packet buffer	768Kbits
Processing	Store-and-Forward
Switch Properties	Switching latency: <7 μs Switching bandwidth: 1.6Gbps
<b>Power</b>	
Input Power	24 - 110 VDC on 4-pin M12 A-coded male connector
Power Consumption(Typ.)	<3 Watts Max.
Overload Current Protection	Present
Reverse Polarity Protection	Present
<b>Physical Characteristic</b>	
Enclosure	IP-67
Dimension (W x D x H)	62(W) x 30(D) x 200(H) mm 2.44(W) x 1.18(D) x 7.874(H) inch
Weight (g)	748 g
<b>Environmental</b>	
Storage Temperature	-40 to 85°C (-40 to 185°F)
Operating Temperature	-40 to 75°C (-40 to 167°F)
Operating Humidity	5% to 95% Non-condensing
<b>Regulatory Approvals</b>	
EMC	CE EMC (EN 55035, EN 55032), FCC Part 15 B, EN 50155(EN 50121-1, EN 50121-3-2), EN 61000-6-2&4
EMI	EN 55032, CISPR32, EN 61000-3-2, EN 61000-3-3, FCC Part 15 B class A
EMS	EN 55035 (IEC/EN 61000-4-2 (ESD), IEC/EN 61000-4-3 (RS), IEC/EN 61000-4-4 (EFT), IEC/EN 61000-4-5 (Surge), IEC/EN 61000-4-6 (CS), IEC/EN 61000-4-8(PFMF), IEC/EN 61000-4-11 (DIP))
Shock	IEC 60068-2-27
Free Fall	IEC 60068-2-31
Vibration	IEC 60068-2-6
Safety	EN 62368-1
Other	EN 50155 (IEC 61373), EN 50121-4
<b>Warranty</b>	5 years

Copyright© 2025 ORing

All rights reserved.



Please visit our website for more information.

<https://oringnet.com/en/>

ORing Industrial Networking Corp.

 TEL: +886-2-2218-1066 Website: www.oringnet.com  
 FAX: +886-2-2218-1014 E-mail: support@oringnet.com