

EMX-W880P

Intel® Core™ Ultra Processors Processors, supports LGA
1851 CPU Mini ITX motherboard

User's Manual

3rd Ed – 29 January 2026

Copyright Notice

Copyright © 2026 Avalue Technology Inc., ALL RIGHTS RESERVED.

Part No: E2047EM8802R

Document Amendment History

Revision	Date	By	Comment
1 st	August 2025	Avalue	Initial Release
2 nd	November 2025	Avalue	Update System Specifications
3 rd	January 2026	Avalue	Update System Specifications

Declaration of Conformity



This device complies with part 15 FCC rules. Operation is subject to the following two conditions:

(1) This device may not cause harmful interference.

(2) This device must accept any interference received including interference that may cause undesired operation.

This equipment has been tested and found to comply with the limits for a class "a" digital device, pursuant to part 15 of the FCC rules.

These limits are designed to provide reasonable protection against harmful interference when the equipment is operated in a commercial environment. This equipment generates, uses, and can radiate radio frequency energy and, if not installed and used in accordance with the instruction manual, may cause harmful interference to radio communications.

Operation of this equipment in a residential area is likely to cause harmful interference in which case the user will be required to correct the interference at his own expense.

CE statement

The product(s) described in this manual complies with all application European Union (CE) directives if it has a CE marking. For computer systems to remain CE compliant, only CE-compliant parts may be used. Maintaining CE compliance also requires proper cable and cabling techniques.

Notice

This guide is designed for experienced users to setup the system within the shortest time. For detailed information, please always refer to the electronic user's manual.

Copyright Notice

© 2026 by Avalue Technology Inc. All rights are reserved. No parts of this manual may be copied, modified, or reproduced in any form or by any means for commercial use without the prior written permission of Avalue Technology Inc. All information and specification provided in this manual are for reference only and remain subject to change without prior notice.

Acknowledgements

Intel and Pentium are trademarks of Intel Corporation.

Microsoft Windows is registered trademark of Microsoft Corp.

All other product names or trademarks are properties of their respective owners.

Disclaimer

This manual is intended to be used as a practical and informative guide only and is subject to change without notice. It does not represent a commitment on the part of Avalue. This

EMX-W880P User's Manual

product might include unintentional technical or typographical errors. Changes are periodically made to the information herein to correct such errors, and these changes are incorporated into new editions of the publication.

A Message to the Customer

Avalue Customer Services

Each and every Avalue's product is built to the most exacting specifications to ensure reliable performance in the harsh and demanding conditions typical of industrial environments. Whether your new Avalue device is destined for the laboratory or the factory floor, you can be assured that your product will provide the reliability and ease of operation for which the name Avalue has come to be known.

Your satisfaction is our primary concern. Here is a guide to Avalue's customer services. To ensure you get the full benefit of our services, please follow the instructions below carefully.

Technical Support and Assistance

1. Visit the Avalue website at <https://www.avalue.com/> where you can find the latest information about the product.
2. Contact your distributor or our technical support team or sales representative for technical support if you need additional assistance. Please have following information ready before you call:
 - Product name and serial number
 - Description of your peripheral attachments
 - Description of your software (operating system, version, application software, etc.)
 - A complete description of the problem
 - The exact wording of any error messages

To receive the latest version of the user's manual; please visit our Web site at:

www.avalue.com

Product Warranty (Returns & Warranties policy)

1. Purpose

Avalue establishes the following maintenance specifications and operation procedures for providing the best quality of service and shortened repair time to our customers.

2. Warranty

2.1 Warranty Period

Avalue endeavors to offer customers the most comprehensive post-sales services and protection; besides offering a 2-year warranty for standard Avalue products, an extended warranty service can also be provided based on additional request from the customer. Within the warranty period, customers are entitled to receive comprehensive and prompt repair and warranty.

Standard products manufactured by Avalue are offered a 2-year warranty, from the date of delivery from Avalue. For ODM/OEM products manufactured by Avalue or PCBA with conformal coating, will follow up the define warranty of the agreement, otherwise will be offered 1-year warranty for ODM/OEM products but non-warranty for PCBA with conformal coating. For outsourcing parts kit by Avalue (ex: Motherboard, LCD touch panel, CPU, RAM, HDD) are offered a 6-month warranty, and Mobile/Tablet PC battery are offered a warranty of the half year, from the date of delivery by Avalue. Products before the mass production stage, i.e. engineering samples are not applied in this warranty or service policy. For extended warranty and cross-territory services, product defects resulting from design, production process or material are covered by the pre-set warranty period after the date of delivery from Avalue. For non-Avalue products, the product warranty and repair time shall be based on the service standards provided by the original manufacturer; in principle Avalue will provide these products a warranty service for no more than one year.

2.2 Maintenance services within the warranty period

In the case of Avalue product DOA (Defect-on-Arrival) when the customer finds any defect within 1 month after the delivery, Avalue will replace it with a new product in a soonest way. Except for custom products, once the customer is approved of a Cross-Shipment Agreement, which allows for delivery a new product to the customer before receiving the defective one, Avalue will immediately proceed with new product replacement for the said DOA case. On validation of the confirmed defect, Avalue is entitled to reserve the right whether to provide a new product for replacement. For the returned defective new product, it is necessary to verify that there shall be no bruise, alteration, scratch or marking to the appearance, and that none of the delivered accessories missing; otherwise, the customer will be requested to pay a processing fee. On the other hand, if the new product defect is resulting from incorrect configuration or erroneous use by the user instead of any problem of the hardware itself, the customer will also be requested to pay for relevant handling fees.

EMX-W880P User's Manual

As for other conditions, Avalue will handle defects by way of repair. The customer will be requested to send the defective product to an Avalue authorized service center, and Avalue will return the repaired product back to the customer as soon as possible.

2.3 Ruling of an out-of-warranty defect

The following situations are not included in the warranty:

- The warranty period has expired.
- Product has been altered or its label of the serial number has been torn off.
- Product functionality issues resulting from improper use by the user, unauthorized dismantle or alteration, unfit operation environment, improper maintenance, accident or other causes. Avalue reserves the right for the ruling of the aforementioned situations.
- Product damage resulting from lightning, flood, earthquake or other calamities.
- The warranty rules of non-Avalue products and accessories shall be in accordance with standards set up by the original manufacturer. These products and accessories include RAM, HDD, FDD, CD-ROM, CPU, FAN, etc.
- Product upgrade request or test request submitted by the customer after expiration of the warranty.
- PCBA with conformal coating.
- Avalue semi-product and outsourced products without Avalue serial number.
- Products before the mass production stage, i.e. engineering samples.

3. Procedure for sending for repair

3.1 Attain a RMA number

A customer's rejected product returned for repair shall have a RMA (Return Merchandise Authorization) number. Without a RMA number, Avalue will not provide any repair service for the rejected product, and the product will be returned to the customer at customer's cost. Avalue will not issue any notice for the return of the product.

Each returned product for repair shall have a RMA number, which is simply the authorization of the return for repair; it is not a guarantee that the returned goods can be repaired or replaced. For applying for a RMA number, the customer may enter the eRMA webpage of Avalue <https://www.avalue.com/en/member> and log-in with an account number and a password authorized by Avalue. The system will then automatically issue a RMA number.

When applying for the RMA number, it is essential to fill in basic information of the customer and the product, together with detailed description of the problem encountered. If possible, avoid using ambiguous words such as "does not work" or "problematic". Without a substantial description of the problem, it is hard to start the repair and will cause prolonged repair time. Lacking detailed statement of fault steps also makes the problem hard to be identified, sometimes resulting in second-time repairs.

In case the customer can't define the cause of problem, please contact Avalue application engineers. Sometimes when the problem can be resolved even before the customer sends back the product.

On the other hand, if the customer only returns the key parts to Avalue for repair, it is necessary that the serial number of the entire unit is given in the "Problem Description" field, so that warranty period can be ruled accordingly; or Avalue will handle the case as an Out-of- warranty case.

3.2 Return of faulty product for repair

It is recommended that the customer not to return the accessories (manual, connection cables, etc.) with the products for repair, devices such as CPU, DRAM, CF memory card, etc., shall also be removed from the faulty goods before return for repair. If these devices are relevant to described repair problems and necessary to be returned with the goods; please clearly indicate the items included in the eRMA application form. Avalue shall not be responsible for any item that is not itemized. Moreover, make sure the problem(s) are detailed in the "Problem Description" field.

In the list of delivery, the customer may fill-in a value which is lower than the actual value, to prevent customs levying a higher tax over the excessive value of the return goods. The customer shall be held responsible for extra fees caused by this. We strongly recommend that "Invoice for customs purpose only with no commercial value" be indicated on the delivery note. Also for the purpose of expedited handling, please printout the RMA number and put it in the carton, also indicate the number outside of the carton, with the recipient addressing to Avalue RMA Department.

When returning the defective product, please use an anti-static bag or ESD material to pack it properly. In case of improper packing resulting in damages in the transportation process, Avalue reserves the right to reject the un-repaired faulty good at the customer's costs. Furthermore, it is suggested that the faulty goods shall be sent via a door-to-door courier service. The customer shall be held responsible for any customs clearance fee or extra expenses if Air-Cargo is used for the delivery.

In case of a DOA situation of a new product, Avalue will be responsible for the product and the freight. If the faulty goods are within the warranty period, the sender will take responsibility for the freight. For an out-of-warranty case, the customer shall be responsible for the freight of both trips.

3.3 Maintenance Charge

Avalue will charge a moderate repair fee for the following conditions:

- The warranty period has expired.
- Product has been altered or its label of the serial number has been torn off.
- Product functionality issues resulting from improper use by the user, unauthorized dismantle or alteration, unfit operation environment, improper maintenance, accident

EMX-W880P User's Manual

or other causes. Avalue reserves the right for the ruling of the aforementioned situations.

- Product damage resulting from lightning, flood, earthquake or other calamities.
- The warranty rules for non-Avalue products and accessories shall be in accordance with standards set up by the original supplier. These products and accessories include RAM, HDD, FDD, CD-ROM, CPU, FAN, etc.
- Product upgrade request or test request submitted by the customer after expiry of the warranty.
- PCBA with conformal coating.
- Avalue semi-product and outsourced products without Avalue serial number
- Products before the mass production stage, i.e. engineering samples.
- In case the products received are examined as NPF (No Problem Found) within the warranty period, the customer shall be responsible for the freight of both trips.
- Please contact your local distributor to examine in advance to prevent unnecessary freight cost.

For system failure of out-of-warranty products, Avalue will provide a quotation prior to repair service. When the customer applies for the cost, please refer to the Quotation number. In case the customer does not return the DOA product that has already been replaced by a new one, or the customer does not sign back the quotation of the out-of-warranty maintenance, Avalue reserves the right of whether or not to provide the repair service. In case the customer does not reply in 3 months, Avalue shall directly scrap or return the product back to customer at customer's cost without further notice to the customer.

3.4 Maintenance service of phased-out products

For servicing phased-out products, Avalue provides an extended period, starting the date of phase-out, as a guaranteed maintenance period of such products, for continuance of the maintenance service to meet customer's requirements. In case of unexpected factors causing Avalue to be unable to repair/replace a warranted but phased-out product, Avalue will, depending on the availability, upgrade the product (free of charge with continued warranty period as of the original product), or, give partial refund (based on the length of the remaining warranty period) to solve this kind of problem.

3.5 Maintenance Report

On completion of repair of a defective product, a Maintenance Report indicating the maintenance result and part(s) replaced (if any) will be sent to the customer together with the product. If the customer demands an additional maintenance analysis report, a service fee of various level will be charged depending on the warranty status. In case the analysis result shows that the defect attributes to Avalue's faulty design or process, the analysis fee will be exempted.

4. Service Products

Avalue provides service products to manage with different customer needs. Should you have any need, please consult to Avalue Sales Department.

Defect Analysis Report (DAR)

Avalue provides DAR (Defect Analysis Report) services aiming to elevating customer satisfaction. A DAR includes defect cause identification/verification/suggestion and improvement precautions, with instructions on correct usage for the avoidance of any reoccurrence.

Upgrade Service

Avalue is capable to provide system upgrade service for customization requirements. This upgrade service is applicable for main parts, such as CPU, memory, HDD, SSD, storage devices; also replacements motherboards of systems. Please contact Avalue sales for details to evaluate the possibility of system upgrade service and obtain information of lead time and price.

Safety Instructions

Safety Precautions

Before installing and using this device, please note the following precautions.

1. Read these safety instructions carefully.
2. Keep this User's Manual for future reference.
3. Disconnected this equipment from any AC outlet before cleaning.
4. For plug-in equipment, the power outlet socket must be located near the equipment and must be easily accessible.
5. Keep this equipment away from humidity.
6. Put this equipment on a reliable surface during installation. Dropping it or letting it fall may cause damage.
7. Make sure the voltage of the power source is correct before connecting the equipment to the power outlet.
8. Use a power cord that has been approved for using with the product and that it matches the voltage and current marked on the product's electrical range label. The voltage and current rating of the cord must be greater than the voltage and current rating marked on the product.
9. Position the power cord so that people cannot step on it. Do not place anything over the power cord.
10. All cautions and warnings on the equipment should be noted.
11. If the equipment is not used for a long time, disconnect it from the power source to

EMX-W880P User's Manual

avoid damage by transient overvoltage.

12. Never pour any liquid into an opening. This may cause fire or electrical shock.











13. Never open the equipment. For safety reasons, the equipment should be opened only by qualified service personnel. If one of the following situations arises, get the equipment checked by service personnel:

- The power cord or plug is damaged.
- Liquid has penetrated into the equipment.
- The equipment has been exposed to moisture.
- The equipment does not work well, or you cannot get it work according to the user's manual.
- The equipment has been dropped and damaged.
- The equipment has obvious signs of breakage.







14. **CAUTION:** Danger of explosion if battery is incorrectly replaced. Replace only with the same or equivalent type recommended by the manufacturer.

15. Equipment intended only for use in a **RESTRICTED ACCESS AREA**.

Explanation of Graphical Symbols

	Warning	A WARNING statement provides important information about a potentially hazardous situation which, if not avoided, could result in death or serious injury.
	Caution	A CAUTION statement provides important information about a potentially hazardous situation which, if not avoided, may result in minor or moderate injury to the user or patient or in damage to the equipment or other property.
	Note	A NOTE provides additional information intended to avoid inconveniences during operation.
		Direct current.
		Alternating current
		Stand-by, Power on
		FCC Certification
		CE Certification
		Follow the national requirements for disposal of equipment.
		Stacking layer limit
		This side up

EMX-W880P User's Manual

		<p>Fragile Packaging</p>
		<p>Beware of water damage, moisture-proof</p>
		<p>Carton recyclable</p>
		<p>Handle with care</p>
		<p>Follow operating instructions of consult instructions for use.</p>
		<p>WARNING</p> <ul style="list-style-type: none"> ● INGESTION HAZARD: This product contains a button cell or coin battery. ● DEATH or serious injury can occur if ingested. ● A swallowed button cell or coin battery can cause Internal Chemical Burns in as little as 2 hours. ● KEEP new and used batteries OUT OF REACH of CHILDREN. <p>Seek immediate medical attention if a battery is suspected to be swallowed or inserted inside any part of the body.</p>

Disposing of your old product

WARNING:

There is danger of explosion if the battery is mishandled or incorrectly replaced. Replace only with the same type of battery. Do not disassemble it or attempt to recharge it outside the system. Do not crush, puncture, dispose of in fire, short the external contacts, or expose to water or other liquids. Dispose of the battery in accordance with local regulations and instructions from your service provider.

CAUTION:

- Lithium Battery Caution: Danger of explosion if battery is incorrectly replaced. Replace only with same or equivalent type. Dispose batteries according to manufacturer's instructions.
- Disposal of a BATTERY into fire or a hot oven, or mechanically crushing or cutting of a BATTERY, that can result in an EXPLOSION
- Leaving a BATTERY in an extremely high temperature surrounding environment that can result in an EXPLOSION or the leakage of flammable liquid or gas.
- A BATTERY subjected to extremely low air pressure that may result in an EXPLOSION or the leakage of flammable liquid or gas.

Mise en garde!

AVERTISSEMENT : Il existe un risque d'explosion si la batterie est mal manipulée ou remplacée de manière incorrecte. Remplacez uniquement par le même type de batterie. Ne le démontez pas et ne tentez pas de le recharger en dehors du système. Ne pas écraser, percer, jeter au feu, court-circuiter les contacts externes ou exposer à l'eau ou à d'autres liquides. Jetez la batterie conformément aux réglementations locales et aux instructions de votre fournisseur de services.

MISE EN GARDE:

- Pile au lithium Attention : Danger d'explosion si la pile n'est pas remplacée correctement. Remplacer uniquement par un type identique ou équivalent. Jetez les piles conformément aux instructions du fabricant.
- L'élimination d'une BATTERIE dans le feu ou dans un four chaud, ou l'écrasement ou le découpage mécanique d'une BATTERIE, pouvant entraîner une EXPLOSION
- Laisser une BATTERIE dans un environnement à température extrêmement élevée pouvant entraîner une EXPLOSION ou une fuite de liquide ou de gaz inflammable.
- UNE BATTERIE soumise à une pression d'air extrêmement basse pouvant entraîner une EXPLOSION ou une fuite de liquide ou de gaz inflammable.

Content

- 1. Getting Started..... 19**
- 1.1 Safety Precautions 19
- 1.2 Packing List..... 19
- 1.3 Manual Objectives..... 20
- 1.4 System Specifications 21
- 1.5 Architecture Overview—Block Diagram 26
- 2. Hardware Configuration..... 27**
- 2.1 Product Overview..... 28
- 2.2 Jumper and Connector List..... 29
- 2.3 Setting Jumpers & Connectors 31
- 2.3.1 PCIe x16 Mode selector (JPEG_SET1) 31
- 2.3.2 JRTC connector (JRTC1)..... 31
- 2.3.3 LCD Backlight Mode select (JPWM1) 32
- 2.3.4 Configuration ID & PMBus Address selector (JCFGID1)..... 32
- 2.3.5 AT/ATX Power Mode selector (JSATX1) 33
- 2.3.6 LVDS Backlight connector (JBKL1) 33
- 2.3.7 Serial Port 1 RS232/422/485 connector (JCOM1)..... 34
- 2.3.8 Serial Port 2 RS232/422/485 connector (JCOM2)..... 35
- 2.3.9 General purpose I/O connector (JDIO1) 36
- 2.3.10 USB3.0 connector (JUSB1)..... 36
- 2.3.11 USB2.0 connector (JUSB2)..... 37
- 2.3.12 RTC Battery connector (BT1)..... 37
- 2.3.13 Front Audio connector (JFAUD1) 38
- 2.3.14 eSPI debug connector (JESPI1)..... 38
- 2.3.15 Front Panel connector (JFPT1) 39
- 2.3.16 CPU fan connector (JC_FAN1) 39
- 2.3.17 System fan connector (JS_FAN1)..... 40
- 2.3.18 ATX Power connector (ATXPWR1)..... 40
- 2.3.19 ATX Power connector (ATXPWR2)..... 41
- 2.3.20 Auxiliary Panel connector (JAUXP1)..... 41
- 2.3.21 JTCP_SPI_PD connector (JTCP_SPI_PD1)..... 42
- 2.3.22 BIOS SPI connector (JSPI1) 42
- 2.3.23 PMBus connector (JPC1)..... 43
- 2.3.24 Serial Port connector (COM3/4/5)..... 43
- 2.3.25 Speaker connector (JSPK1)..... 44
- 2.3.26 LVDS/eDP Connector (JLVDS1)..... 44

3. Drivers Installation.....	45
3.1 Install Chipset Driver	46
3.2 Install Graphics Driver	47
3.3 Install LAN Driver	48
3.4 Install ME Driver	49
3.5 Install Audio Driver	50
3.6 Install GNA Driver	51
3.7 Install NPU Driver.....	52
3.8 Install RAID Driver.....	53
3.9 Install Serial IO Driver	54
4. BIOS Setup	55
4.1 Introduction	56
4.2 Starting Setup	56
4.3 Using Setup	57
4.4 Getting Help.....	58
4.5 In Case of Problems.....	58
4.6 BIOS setup.....	59
4.6.1 Main Menu.....	59
4.6.1.1 System Language	59
4.6.1.2 System Date.....	60
4.6.1.3 System Time	60
4.6.2 Advanced Menu	60
4.6.2.1 CPU Configuration	61
4.6.2.1.1 Efficient-core Information.....	61
4.6.2.2 Power & Performance	62
4.6.2.2.1 CPU - Power Management Control.....	62
4.6.2.2.1.1 View/Configure Turbo Options	63
4.6.2.2.1.1.1 Turbo Ratio Limit Options	64
4.6.2.3 PCH-FW Configuration	64
4.6.2.3.1 Firmware Update Configuration.....	65
4.6.2.4 Trusted Computing	65
4.6.2.5 ACPI Settings.....	66
4.6.2.6 IT5792 Super IO Configuration	66
4.6.2.6.1 Serial Port 1 Configuration	67
4.6.2.6.2 Serial Port 2 Configuration	68
4.6.2.6.3 Serial Port 3 Configuration	68
4.6.2.6.4 Serial Port 4 Configuration	69
4.6.2.6.5 Serial Port 5 Configuration	70
4.6.2.6.6 Serial Port 6 Configuration	70
4.6.2.7 EC 5792 H/W monitor	71

EMX-W880P User's Manual

4.6.2.7.1	Clear below data:S0/S5/G3 and Duration	72
4.6.2.8	S5 RTC Wake Settings	72
4.6.2.9	Serial Port Console Redirection	73
4.6.2.10	USB Configuration	73
4.6.2.11	Network Stack Configuration	74
4.6.2.12	NVMe Configuration	75
4.6.2.13	Intel(R) Rapid Storage Technology	75
4.6.3	Chipset	76
4.6.3.1	System Agent (SA) Configuration	76
4.6.3.1.1	Memory Configuration	77
4.6.3.1.2	Graphics Configuration	77
4.6.3.1.3	TCSS setup menu	78
4.6.3.1.3.1	TCSS USB Configuration	79
4.6.3.1.3.2	PCI Express Root Port 0	80
4.6.3.1.3.3	PCI Express Root Port 1	81
4.6.3.1.4	VMD setup menu	82
4.6.3.1.5	VT-d setup menu	83
4.6.3.2	PCH-IO Configuration	83
4.6.3.2.1	PCI Configuration	84
4.6.3.2.1.1	PCI Express Root Port 1 (M2KE1)	84
4.6.3.2.1.1.1	PCIe EQ settings	85
4.6.3.2.1.2	PCI Express Root Port 3 (LAN1)	85
4.6.3.2.1.2.1	PCIe EQ settings	86
4.6.3.2.1.3	PCI Express Root Port 4 (LAN2)	87
4.6.3.2.1.3.1	PCIe EQ settings	87
4.6.3.2.1.4	PCI Express Root Port 5 (LAN3)	88
4.6.3.2.1.4.1	PCIe EQ settings	89
4.6.3.2.1.5	PCI Express Root Port 6 (LAN4)	89
4.6.3.2.1.5.1	PCIe EQ settings	90
4.6.3.2.1.6	PCI Express Root Port 13 (M2KM1)	90
4.6.3.2.1.6.1	PCIe EQ settings	91
4.6.3.2.1.7	PCI Express Root Port 21 (M2KM2)	92
4.6.3.2.1.7.1	PCIe EQ settings	92
4.6.3.2.2	SATA Configuration	93
4.6.3.2.3	HD Audio Configuration	94
4.6.3.3	Board & Panel Configuration	94
4.6.4	Security	96
4.6.4.1	Secure Boot	97
4.6.4.1.1	Restore Factory Keys	97
4.6.4.1.2	Reset To Setup Mode	98

4.6.4.1.3	Expert Key Management	98
4.6.5	Boot	99
4.6.6	Save and Exit	99
4.6.6.1	Save Changes and Reset	100
4.6.6.2	Discard Changes and Reset	100
4.6.6.3	Restore Defaults	100
4.6.6.4	Launch EFI Shell from filesystem device	100
4.6.7	MEBx	101
5.	Mechanical Drawing	102
6.	Installation	104
6.1	Installing E-KEY M.2 2230	105
6.2	Installing M-KEY M.2 2242	106
6.3	Installing M-KEY M.2 2280	108
6.3.1	Top side M-KEY M.2 2280	108
6.3.2	Installing M-KEY M.2 2280	109
6.3.3	Bottom side M-KEY M.2 2280	109
7.	IPMI User Manual	112
7.1	Initial Screen	113
7.2	About Window	113
7.3	Start/Stop/Reset	114
7.4	Set the number of Loop Test iterations	115
7.5	Configure Loop Test items	115
7.6	Countdown timer for the Command execution or the current Loop Test status	116
7.7	Response and log records generated by the Loop Test	117
7.8	Number of completed Loop Tests	117
7.9	Search for / verify IPMI devices	118
7.10	Verify / control IPMI devices	119
7.11	Display of results returned from Loop Test, IPMI device search, or command execution	121
7.12	Device GUID	122
7.13	System GUID	122
7.14	Health Status	123
7.15	Sensor Data	123
7.16	Power Off	124
7.17	Power On	124
7.18	Power Soft	125
7.19	Power Reset	125
7.20	Power Cycle	126
7.21	SOL Info	126
7.22	SOL Open	127
7.23	BIOS Update	127

EMX-W880P User's Manual

7.24	Change Password	128
7.25	Custom Command	130
7.26	Loop Test	133

1. Getting Started

1.1 Safety Precautions

Warning!



Always completely disconnect the power cord from your chassis whenever you work with the hardware. Do not make connections while the power is on. Sensitive electronic components can be damaged by sudden power surges. Only experienced electronics personnel should open the PC chassis.

Caution!



Always ground yourself to remove any static charge before touching the CPU card. Modern electronic devices are very sensitive to static electric charges. As a safety precaution, use a grounding wrist strap at all times. Place all electronic components in a static-dissipative surface or static-shielded bag when they are not in the chassis.

1.2 Packing List

Before installation, please ensure all the items listed in the following table are included in the package.

Item	Description	Q'ty
1	EMX-W880P Mainboard	1
2	IO Shield	1
3	SATA cables	2



If any of the above items is damaged or missing, contact your retailer.

1.3 Manual Objectives

This manual describes in details Avalue Technology EMX-W880P Single Board.

We have tried to include as much information as possible but we have not duplicated information that is provided in the standard IBM Technical References, unless it proved to be necessary to aid in the understanding of this board.

We strongly recommend that you study this manual carefully before attempting to set up EMX-W880P or change the standard configurations. Whilst all the necessary information is available in this manual we would recommend that unless you are confident, you contact your supplier for guidance.

Please be aware that it is possible to create configurations within the CMOS RAM that make booting impossible. If this should happen, clear the CMOS settings, (see the description of the Jumper Settings for details).

If you have any suggestions or find any errors regarding this manual and want to inform us of these, please contact our Customer Service department with the relevant details.

1.4 System Specifications

EMX-W880P	
Product Features	<ul style="list-style-type: none"> ● Intel® Arrow Lake-S (Codename: ARL-S) Core™ Ultra Processor, supports LGA 1851 CPU Up to 125W Max ● Intel® W880 Chipset ● 2 x 262-pin SODIMM Up to 96GB Dual Channel DDR5 6400MHz ● ECC DRAM supported by CPU ● 1 x Intel® i226LM, 2 x Intel® i226V 2.5 Gigabit, 1 x Intel® i210AT (for uBMC) Controller ● Realtek ALC888S with Stereo Class-D ● RealTek ALC105 Stereo Class-D 3W4Ω X2 ● 1 x USB4 Type C Gen2 x2 at I/O with 15W PD, 5V@3A. No Thunderbolt. DP-Alt mode.HDMI +DP connector at I/O ● 1 x LVDS Or eDP 1.4b (2 Lanes) (Maximum: 4 independent displays) ● 2 x SATA III ● 1 x PCIe x16 slot ● 1 x M.2 (2230) E-Key with (PCIe x2 Gen4 & USB 2.0 signal) support WiFi module ● 1 x M.2 (2242/2280) M-Key with (PCIe x4 Gen4 & SATA signal) support SSD (PCBA top side) ● 1 x M.2 (2280/22110 with M.2 Bracket) M-Key with (PCIe x4 Gen4 signal) support SSD (PCBA Bottom side) ● 8 x USB 3.2 Gen2 at I/O ● 2 x USB 3.2 Gen2 by pin header ● 2 x USB 2.0 by pin header ● 2 x RS232/422/485, 3 x RS232 ● 16-bits GPIO ● Support RAID 0, 1 ● Line-out & Mic-in connector header at I/O, Line-in with wafer to support CH5.1. ● TPM IC 2.0 ● ATX Power
System	
CPU	Intel® Arrow Lake-S (Codename: ARL-S) Core™ Ultra Processor, supports LGA 1851 CPU Up to 125W Max
BIOS	AMI uEFI BIOS, 256Mbit SPI Flash ROM
System Chipset	Intel® W880 chipset
I/O Chip	uBMC IT5792(IPMI) or equivalent
System Memory	2 x 262pin SODIMM Up to 96GB Dual Channel DDR5 5600MHz or CSODIMM

EMX-W880P User's Manual

	6400MHz ECC DRAM supported by CPU
Watchdog Timer	H/W Reset, 5~255 seconds/5~255 minutes
H/W Status Monitor	<ul style="list-style-type: none"> ● CPU temperature monitoring ● Voltage monitoring ● CPU fan speed control
RAID	RAID 0, 1
TPM	TPM IC 2.0
iAMT	Yes
Expansion Slot	
M.2	<ul style="list-style-type: none"> ● 1 x M.2 (2230) E-Key with (PCIe x2 Gen4 & USB 2.0 signal) support WiFi module ● 1 x M.2 (2242/2280) M-Key with (PCIe x4 Gen4 signal) support SSD or Other devices (PCBA Bottom side) ● 1 x M.2 (2280/22110 with M.2 Bracket) M-Key with (PCIe x4 Gen4 & SATA signal) support SSD or Other devices (PCBA top side)
PCIe	<p>1 x PCIe x16 Gen4* (from CPU) slot support graphic & NVMe.</p> <p>*PCIe lane configurations: 2 x PCIe x8 or 1 x PCIe x8 + 2 x PCIe x4 (jumper selection for PCI Express Port Configurations)</p> <p>*When using PCIe x16 slots with a riser card or add-on card, there may be a loss with PCIe performance depending on card device.</p>
Storage	
M.2	<ul style="list-style-type: none"> ● 1 x M.2 (2280/22110 with M.2 Bracket) M-Key with (PCIe x4 Gen4 signal) support SSD or Other devices (PCBA Bottom side) ● 1 x M.2 (2242/2280) M-Key with (PCIe x4 Gen4 & SATA signal) support SSD or Other devices (PCBA top side)
SATA	2 x SATA III (Blue color)
Edge I/O	
LAN	4 x RJ45
USB	<p>* 8 x USB 3.2 Gen2, 2 ports share 1.8A.</p> <p>* USB4 Type C Gen2 x2 at I/O with 15W PD, 5V@3A (TYPE C1)</p>
DP	1 x DP (from Type C DP-Alt mode), 1 x DP++ connector
HDMI	1 x HDMI 2.1
Onboard I/O	
COM	<ul style="list-style-type: none"> ● COM 1-2: Support RS232/422/485 selected by BIOS selection - 2 x 2 x 5 pin, pitch 2.00mm connector for COM1~2 support RS232/RS422/RS485 connector selected by BIOS selection. ● COM 3-5: Support RS232 - 3 x 1 x 9 pin, pitch 1.0mm connector for COM 3~5 support RS-232 connector.

USB	1 x 2 x 5 pin pitch 2.54mm connector for 2 x USB 2.0, 2 ports share 1A. 1 x 2 x 10 pin, pitch 2.0mm connector for 2 x USB 3.2 Gen 1, 2 ports share 1.8A.
GPIO	2 x 10 pin, pitch 1.27mm connector for GPIO: 16 bits & +5VS Level SMBus
CPU/System FAN	1 x 4 pin, pitch 2.54mm CPU fan connector with smart fan function 1 x 4 pin, pitch 2.54mm System fan connector with smart fan function
Front Panel	2 x 5 pin, pitch 2.54mm connector for front panel (JFP1)
RTC Battery	1 x 2 Pin Pitch 1.25mm Vertical type battery connector (SMD Type)(BT1) Battery 3V/600mAh 170mm CR2450 Lithium Coin Cell (BT1) * Based on Battery Capacity / Current Consumption = > 4 years
AT/ATX Selector	1 x 3 pin pitch 2.00mm connector for AT/ATX jumper (JSATX1), jumper default (1-2) for ATX mode 2 x 10 pin ATX power connector 2 x 4 pin ATX 12V power connector
Clear CMOS	1 x 3 pin, pitch 2.54mm connector for CMOS Clear (JRTC1), jumper default (1-2) for Normal mode
LVDS	2 x 20 pin, pitch 1.25mm connector for LVDS (JLVDS_EDP1) or eDP (2 Lanes)
LCD Backlight Brightness	1 x 5 pin, pitch 2.00mm Wafer connector for LCD inverter backlight connector (5V/12V) (JBKL1) (+5V/+12V, 1A)
BIOS SPI	1 x 10 pin, pitch 1.0mm connector for BIOS SPI (JSPI1)
Amp Connector	1 x 4 pin, pitch 2.00mm connector for Amplifier 3W4Ω x 2 speaker (JSPK1)
Audio	1 x 2 x 6 pin, pitch 2.00mm connector for front Audio (JFAUD1)
Other	Onboard power-on LED 2 x 4 pin, pitch 2.00mm connector for auxiliary (JAUXP1) LAN active LED by pin header: 2.00mm
Display	
Graphic Chipset	Intel® Xe LPG graphics architecture CPU integrated
Spec. & Resolution	<ul style="list-style-type: none"> ● 1 x DP 1.4: 7680 x 4320@60Hz ● 1 x USB4 Type C at I/O with DP-alt mode ● 1 x HDMI 2.1: 8K@60Hz ● 1 x LVDS: 1920 x 1080@60Hz Dual channel 18/24-bits LVDS (Chrontel CH7513A-BF eDP to LVDS) Or 1 x eDP 1.4b 1920 x 1080@60Hz (2 Lanes) Note: Group A & Group B resolution matrix
Multiple Display	4 Independent Displays
Audio	
Audio Codec	RealTek ALC888S Audio Codec
Amplifier	RealTek ALC105 Stereo Class-D 3W4Ω
Other	Mic-in, Line-out, Line-in with header to support CH5.1.
Ethernet	
LAN Chipset	1 x Intel® i226LM, 2 x Intel® i226V 2.5 Gigabit, 1 x Intel® i210AT(for uBMC)

EMX-W880P User's Manual

	Controller (TSN Capable for Arrow Lake-S processor, dependent on LAN Chipset)																								
LAN Spec.	100/1000/2500 Base-Tx GbE compatible Gigabit Ethernet																								
LED Indicator	<table border="1"> <tr> <th colspan="4">Max. 2.5G LAN Port</th> </tr> <tr> <th colspan="2">ACT/LINK</th> <th colspan="2">SPEED</th> </tr> <tr> <th></th> <th>Definition</th> <th>LED</th> <th>Definition</th> </tr> <tr> <td>Light Off</td> <td>No Link</td> <td>Solid Orange</td> <td>2.5G</td> </tr> <tr> <td>Solid Yellow</td> <td>Connection</td> <td>Solid Green</td> <td>1G/100M</td> </tr> <tr> <td>Yellow Flashing</td> <td>Activity</td> <td>Light Off</td> <td>10M</td> </tr> </table>	Max. 2.5G LAN Port				ACT/LINK		SPEED			Definition	LED	Definition	Light Off	No Link	Solid Orange	2.5G	Solid Yellow	Connection	Solid Green	1G/100M	Yellow Flashing	Activity	Light Off	10M
Max. 2.5G LAN Port																									
ACT/LINK		SPEED																							
	Definition	LED	Definition																						
Light Off	No Link	Solid Orange	2.5G																						
Solid Yellow	Connection	Solid Green	1G/100M																						
Yellow Flashing	Activity	Light Off	10M																						
Mechanical & Environmental																									
Power Requirement	+12V / +5V / 5VSB /+3.3V /-12V																								
ACPI	Single power ATX Support S0, S3, S4, S5																								
Power Mode	AT / ATX mode Switchable Through Jumper																								
Operating Temp.	0~55°C (32~131°F) w/HDD/SSD, ambient 0.5m/s air flow																								
Storage Temp.	-40~ +75°C																								
Operating Humidity	40°C @ 95% Relative Humidity, Non-condensing																								
Size (L x W)	6.7" x 6.7" (170mm x 170mm)																								
Weight	0.46kg																								
Vibration Test	<p>Package Vibration Test</p> <p>Reference IEC60068-2-64 Testing procedures</p> <p>Test Fh: Vibration boardband random Test</p> <ol style="list-style-type: none"> 1. PSD: 0.026G²/Hz, 2.16 Grms 2. Non-operation mode 3. Test Frequency: 5-500Hz 4. Test Axis: X, Y and Z axis 5. 30 min. per each axis <p>Random Vibration Operation</p> <p>Reference IEC60068-2-64 Testing procedures</p> <p>Test Fh: Vibration boardband random Test</p> <ol style="list-style-type: none"> 1. PSD: 0.00454G²/Hz, 1.0 Grms 2. Operation mode 3. Test Frequency: 5-500Hz 4. Test Axis: X, Y and Z axis 5. 30 minutes per each axis 6. IEC 60068-2-64 Test:Fh <p>Random Vibration Non Operation</p>																								

	<p>Reference IEC60068-2-64 Testing procedures</p> <p>Test Fh : Vibration boardband random Test</p> <ol style="list-style-type: none"> 1. PSD: 0.01818G²/Hz, 1.0 Grms 2. Non Operation mode 3. Test Frequency: 5-500Hz 4. Test Axis: X, Y and Z axis 5. 30 minutes per each axis 6. IEC 60068-2-64 Test:Fh
<p>Drop Test</p>	<p>Packing Drop</p> <p>Reference ISTA 2A, Method: IEC-60068-2-32 Test: Ed</p> <p>Drop Test</p> <ol style="list-style-type: none"> 1 One corner, three edges, six faces 2 ISTA 2A, IEC-60068-2-32 Test: Ed
<p>OS Information</p>	<p>BIOS Support:</p> <p>Win11 64bit UEFI, Linux</p>



Note: Specifications are subject to change without notice.

1.5 Architecture Overview—Block Diagram

The following block diagram shows the architecture and main components of EMX-W880P.

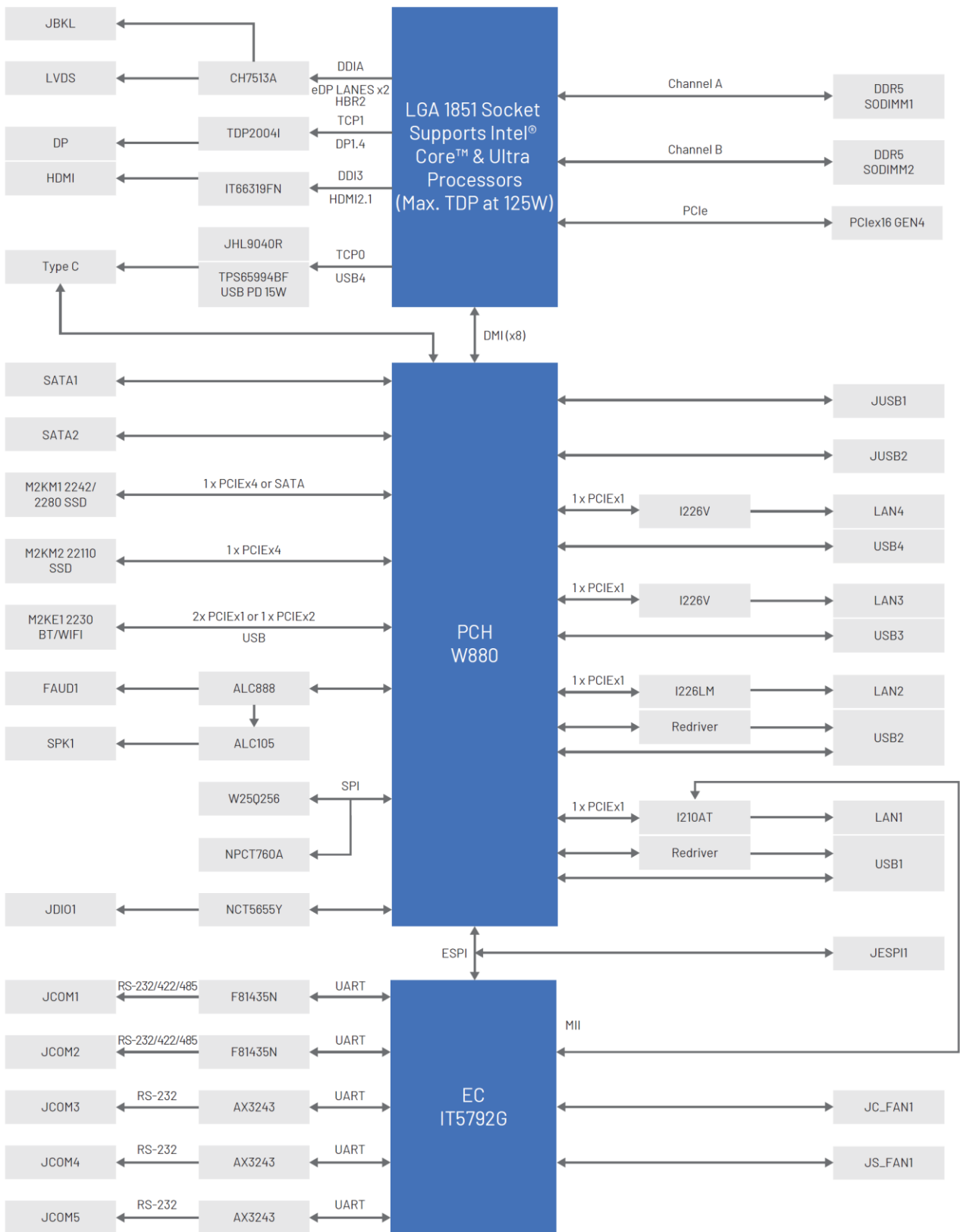

2. Hardware Configuration

2.1 Product Overview

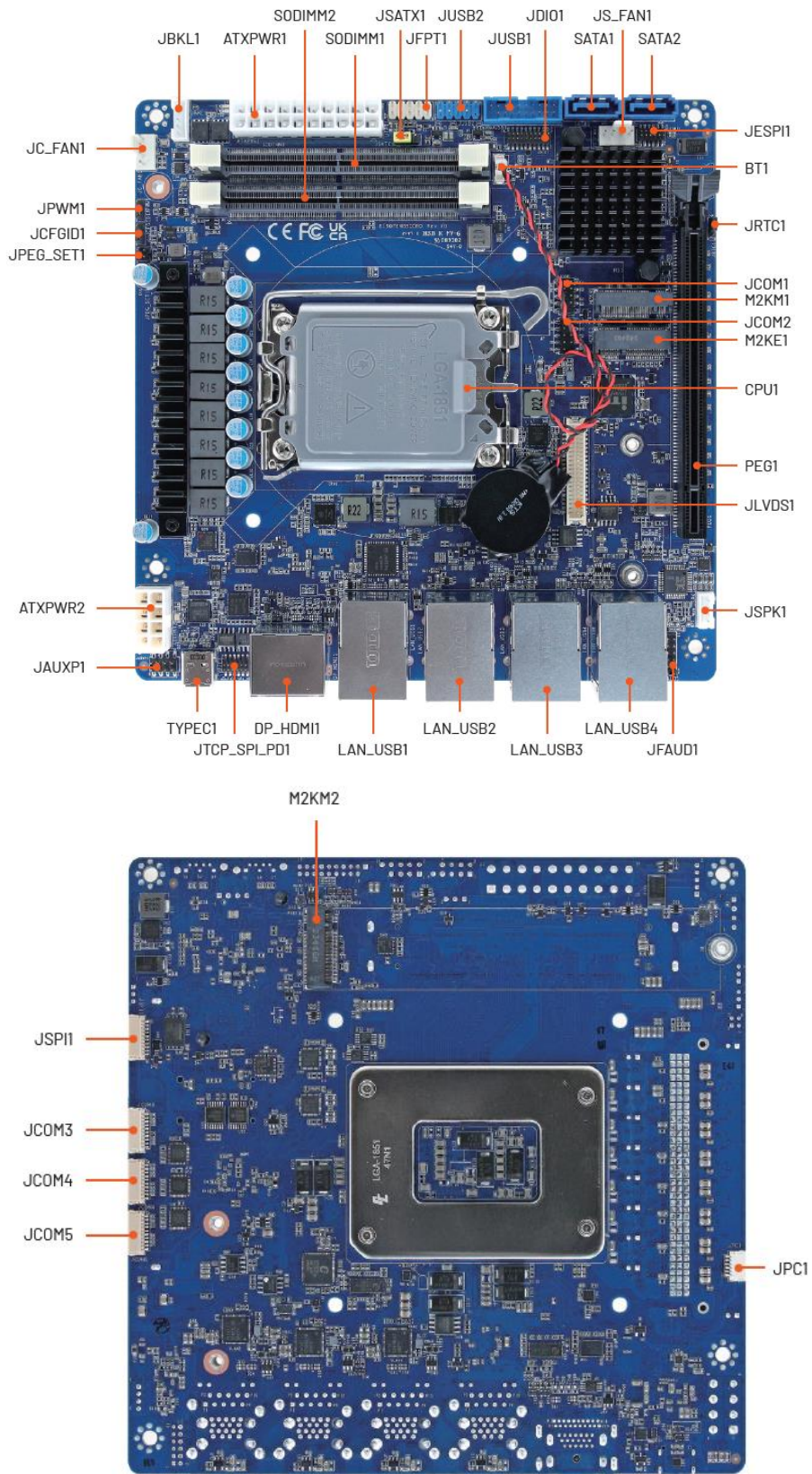

2.2 Jumper and Connector List

You can configure your board to match the needs of your application by setting jumpers. A jumper is the simplest kind of electric switch.

It consists of two metal pins and a small metal clip (often protected by a plastic cover) that slides over the pins to connect them. To “close” a jumper you connect the pins with the clip. To “open” a jumper you remove the clip. Sometimes a jumper will have three pins, labeled 1, 2, and 3. In this case, you would connect either two pins.

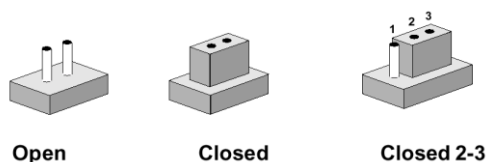

The jumper settings are schematically depicted in this manual as follows:

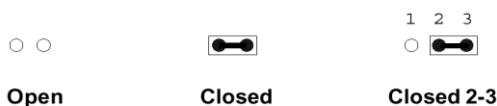

A pair of needle-nose pliers may be helpful when working with jumpers.

Connectors on the board are linked to external devices such as hard disk drives, a keyboard, or floppy drives. In addition, the board has a number of jumpers that allow you to configure your system to suit your application.

If you have any doubts about the best hardware configuration for your application, contact your local distributor or sales representative before you make any changes.

The following tables list the function of each of the board's jumpers and connectors.

Jumpers

Label	Function	Note
JPEG_SET	PCIe x16 Mode selector	2 x 2 header, pitch 2.00mm
JCFGID1	Configuration ID & PMBus Address selector	3 x 1 header, pitch 2.00mm
JPWM1	LCD Backlight Mode selector	3 x 1 header, pitch 2.00mm
JRTC1	Clear CMOS	3 x 1 header, pitch 2.00mm
JSATX1	AT/ATX Power Mode selector	3 x 1 header, pitch 2.54mm

Connectors

Label	Function	Note
JCOM1/2	Serial Port 1/2 RS232/422/485 connector	5 x 2 header, pitch 2.00mm
JCOM3/4/5	Serial Port 3/4/5 RS232 connector	10 x 1 wafer, pitch 1.00mm
JDIO1	General purpose I/O connector	10 x 2 header, pitch 2.00mm

EMX-W880P User's Manual

JBKL1	LVDS Backlight connector	5 x 1 wafer, pitch 2.00mm Note: Matching connector: JST PHR-5
JUSB1	USB 3.0 connector	10 x 2 wafer, pitch 2.00mm
JUSB2	USB 2.0 connector	5 x 2 header, pitch 2.54mm
BT1	RTC Battery connector	2 x 1 wafer, pitch 1.25mm
JFAUD1	Front Audio connector	6 x 2 header, pitch 2.00mm
JESPI1	eSPI debug connector	6 x 2 header, pitch 1.27mm
JSPK1	Speaker connector	4 x 1 wafer, pitch 2.00mm
JFPT1	Front Panel connector	5 x 2 header, pitch 2.54mm
JC_FAN1	CPU fan connector	4 x 1 wafer, pitch 2.54mm
JS_FAN1	System fan connector	4 x 1 wafer, pitch 2.54mm
JLVDS1	LVDS/eDP Connector	20 x 2 wafer, pitch 1.25mm Note: Matching connector: Hirose DF-40DS-1.25C
ATXPWR1	ATX Power connector	10 x 2 wafer, pitch 4.20mm
ATXPWR2	ATX Power connector	4 x 2 wafer, pitch 4.20mm
JAUXP1	Auxiliary Panel connector	4 x 2 header, pitch 2.00mm
JTCP_SPI_PD1	TCP flash connector	6 x 2 header, pitch 1.27mm
JSPI1	BIOS SPI connector	10 x 1 wafer, pitch 1.00mm
JPC1	PMBus connector	6 x 1 wafer, pitch 1.00mm
M2KE1	M.2 2230 Type E Slot	
M2KM1	M.2 2242/2280 Key M Slot	
M2KM2	M.2 Key M 2280/22110 Key M Slot	
SODIMM1/2	262-pin SO-DIMM DDR5 Slot 1/2	
SATA1/2	Serial ATA connector 1/2	
CPU	CPU socket	
PEG1	PCI-e x16 slots	
EC1	EC debug connector	
LAN_USB1/2/3/4	LAN 1/2/3/4 & USB 1/2/3/4	
DP_HDMI1	DP & HDMI	
TYPEC1	USB typeC	

2.3 Setting Jumpers & Connectors

2.3.1 PCIe x16 Mode selector (JPEG_SET1)

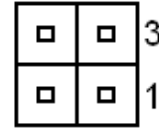
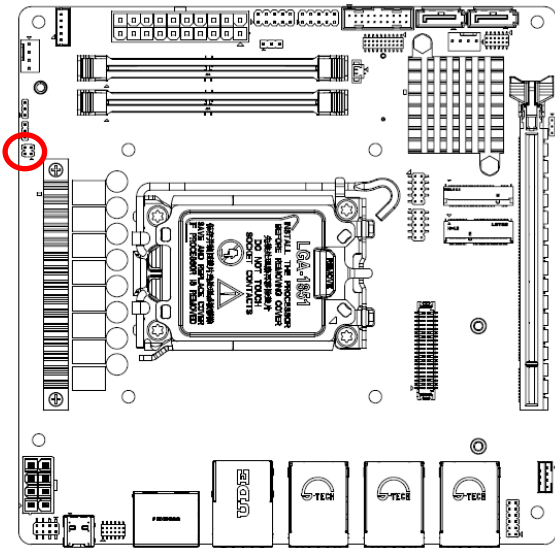

Signal	PIN	PIN	Signal
+1.8V	4	3	GPP_SA15
+1.8V	2	1	GPP_SA16

Note:

GPP_SA15: PCIe Lanes 1-16 select 0

GPP_SA16: PCIe Lanes 1-16 select 1

00 = x16 (default)(1-2,3-4 open)

10 = x8, x8(1-2 short 3-4 open)

01 = Reserved

11 = x8, x4, x4(1-2,3-4 short)

2.3.2 JRTC connector (JRTC1)

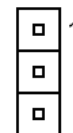
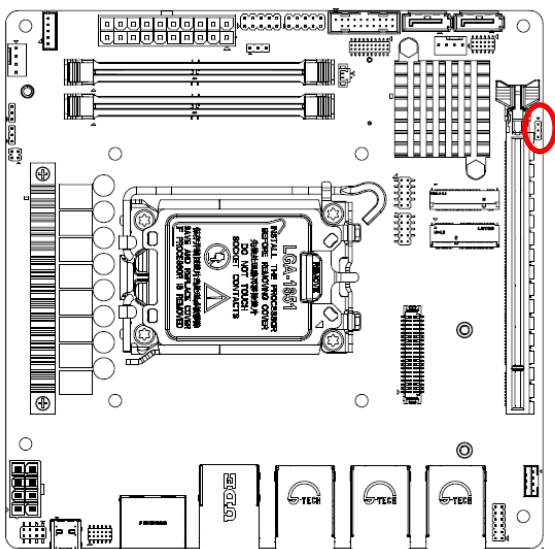

PIN	Signal
1	+3.3V_RTC
2	RTCST#
3	GND

2.3.3 LCD Backlight Mode select (JPWM1)

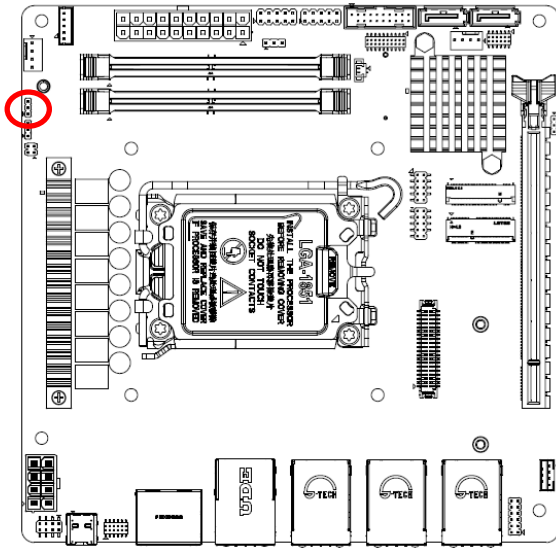

PWM*

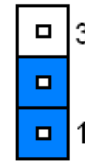

DC

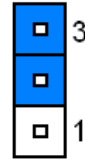

* Default

2.3.4 Configuration ID & PMBus Address selector (JCFGID1)

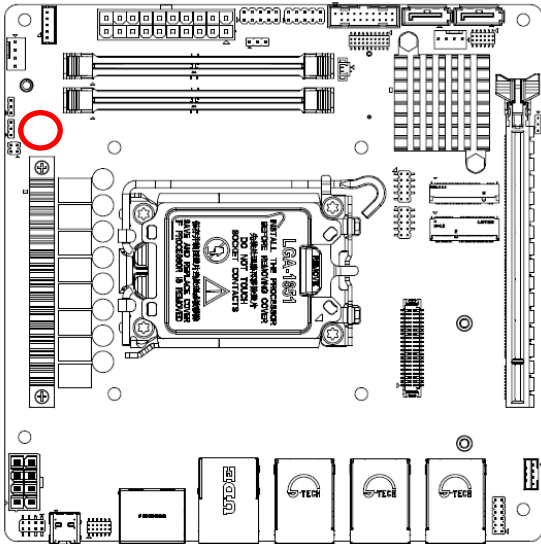

Config ID0*

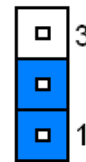

Config ID1

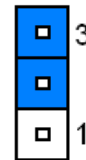

* Default

Note:

This function is reserved for internal use only.

R Value	Configuration ID	PMBus Address
13.7K	0	63
15.4K	1	63

2.3.5 AT/ATX Power Mode selector (JSATX1)

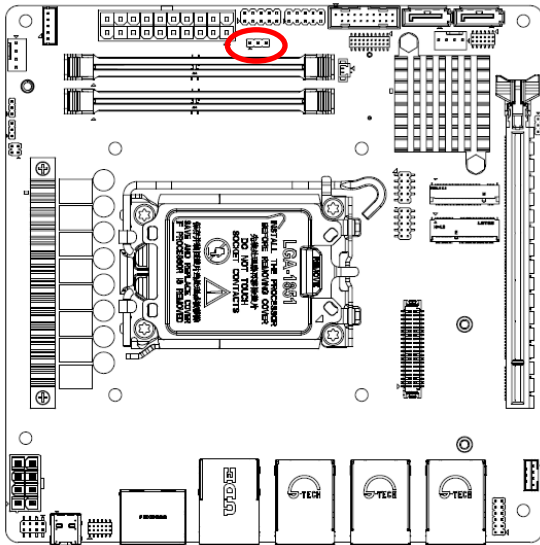

ATX*

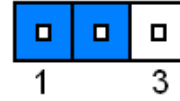

AT

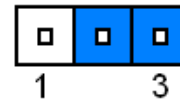

* Default

2.3.6 LVDS Backlight connector (JBKL1)

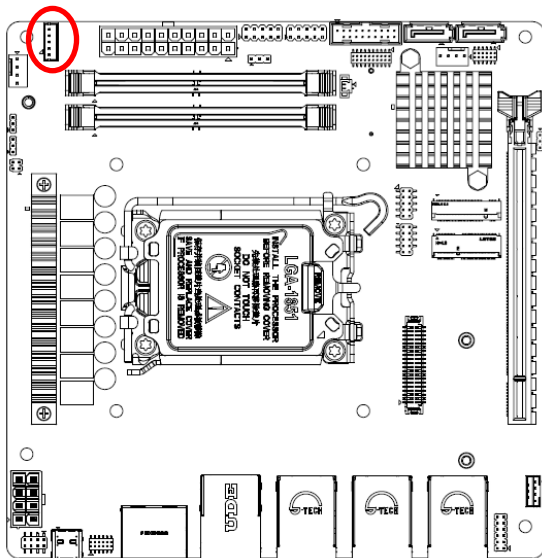

PIN	Signal
5	+5V
4	LVDS_BKLTCTL
3	LVDS_BKLT_EN
2	GND
1	+12V

2.3.7 Serial Port 1 RS232/422/485 connector (JCOM1)

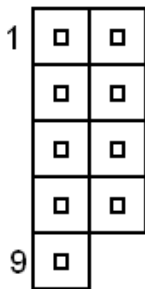
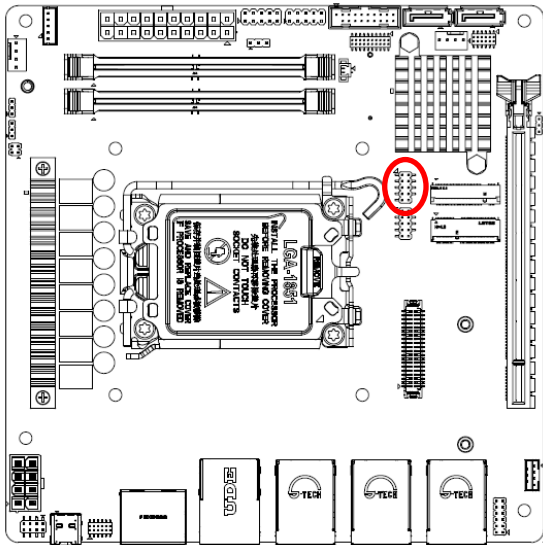

RS232

Signal	PIN	PIN	Signal
DCD#	1	2	RXD
TXD	3	4	DTR#
GND	5	6	DSR#
RTS#	7	8	CTS#
RI#	9		

RS422

Signal	PIN	PIN	Signal
TX-	1	2	TX+
RX+	3	4	RX-
GND	5	6	NC
NC	7	8	NC
NC	9		

RS485

Signal	PIN	PIN	Signal
DATA-	1	2	DATA+
NC	3	4	NC
GND	5	6	NC
NC	7	8	NC
NC	9		

Note:

JCOM1 can be selected to RS232(default)/RS422/RS485 by BIOS selection

2.3.8 Serial Port 2 RS232/422/485 connector (JCOM2)

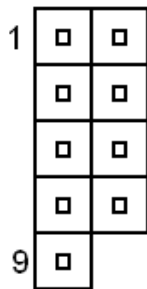
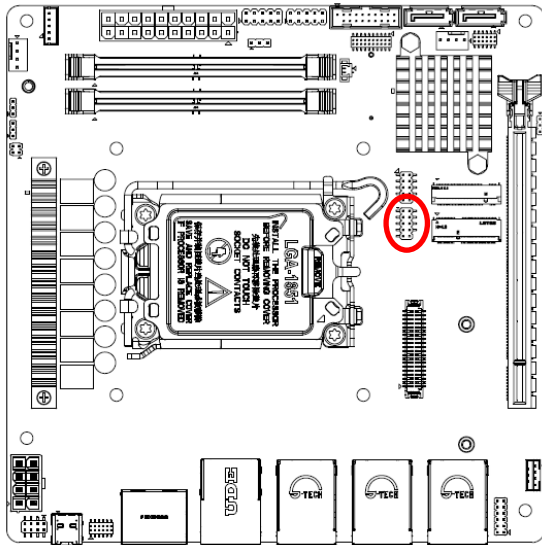

RS232

Signal	PIN	PIN	Signal
DCD#	1	2	RXD
TXD	3	4	DTR#
GND	5	6	DSR#
RTS#	7	8	CTS#
RI#	9		

RS422

Signal	PIN	PIN	Signal
TX-	1	2	TX+
RX+	3	4	RX-
GND	5	6	NC
NC	7	8	NC
NC	9		

RS485

Signal	PIN	PIN	Signal
DATA-	1	2	DATA+
NC	3	4	NC
GND	5	6	NC
NC	7	8	NC
NC	9		

Note:

JCOM2 can be selected to RS232(default)/RS422/RS485 by BIOS selection

2.3.9 General purpose I/O connector (JDIO1)

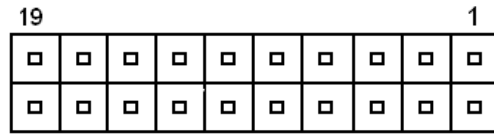
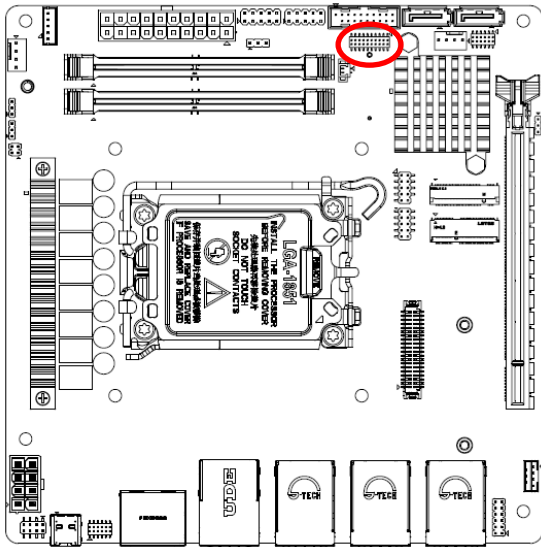

Signal	PIN	PIN	Signal
DI0	1	2	DO0
DI1	3	4	DO1
DI2	5	6	DO2
DI3	7	8	DO3
DI4	9	10	DO4
DI5	11	12	DO5
DI6	13	14	DO6
DI7	15	16	DO7
SMB_CLK_S0_5V	17	18	SMB_SDA_S0_5V
GND	19	20	+5V

2.3.10 USB3.0 connector (JUSB1)

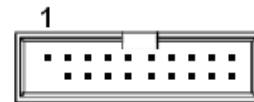
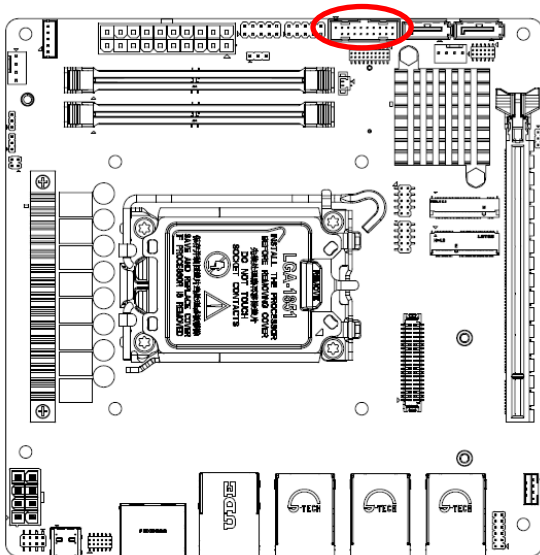

Signal	PIN	PIN	Signal
		1	+5V
+5V	19	2	StdA_SSRX-
StdA_SSRX-	18	3	StdA_SSRX+
StdA_SSRX+	17	4	GND
GND	16	5	StdA_SSTX-
StdA_SSTX-	15	6	StdA_SSTX+
StdA_SSTX+	14	7	GND
GND	13	8	DATA-
DATA-	12	9	DATA+
DATA+	11	10	NC

2.3.11 USB2.0 connector (JUSB2)

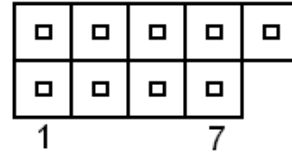
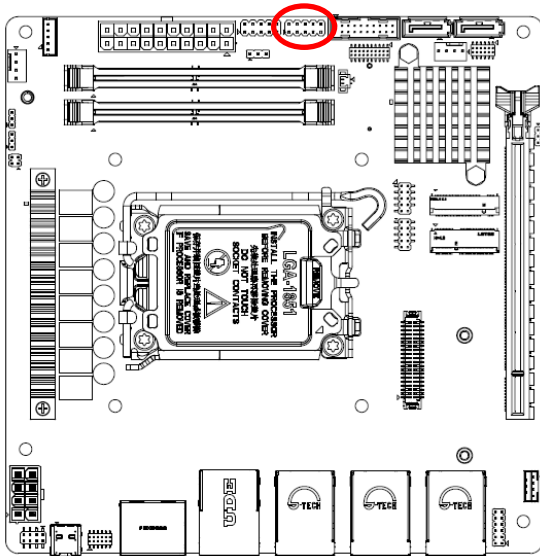

Signal	PIN	PIN	Signal
+5V	1	2	+5V
DATA-	3	4	DATA-
DATA+	5	6	DATA+
GND	7	8	GND
		10	GND

2.3.12 RTC Battery connector (BT1)

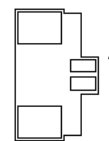
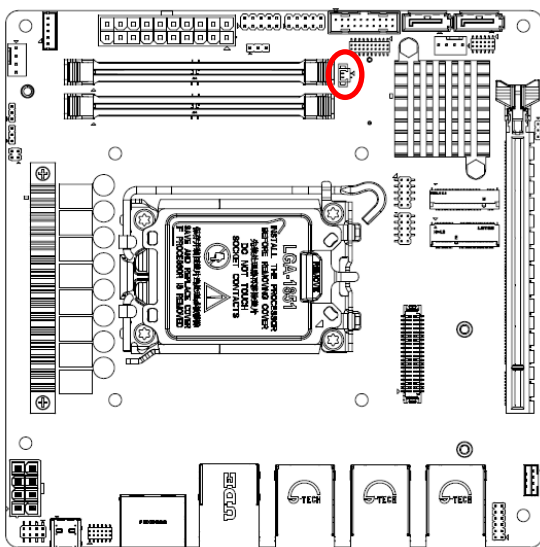

PIN	Signal
1	+VDD_RTC
2	GND

2.3.13 Front Audio connector (JFAUD1)

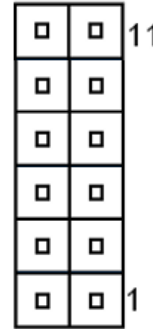
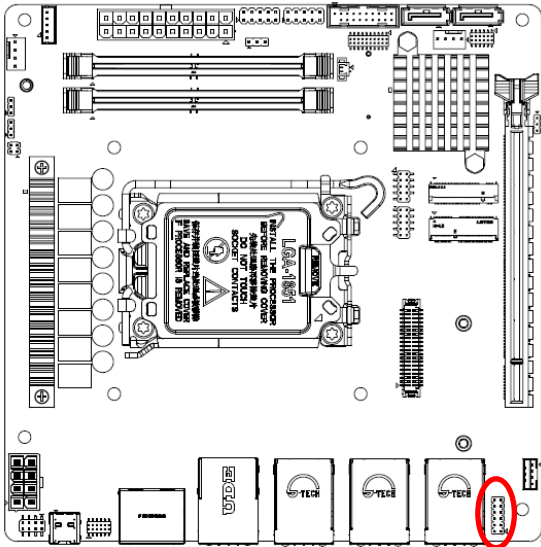

Signal	PIN	PIN	Signal
GND	12	11	MIC1_JD
LINE1_JD	10	9	LINEOUT1_JD
MICIN_L	8	7	MICIN_R
LINEIN_L	6	5	LINEIN_R
GND	4	3	GND
LINEOUT_L	2	1	LINEOUT_R

2.3.14 eSPI debug connector (JESPI1)

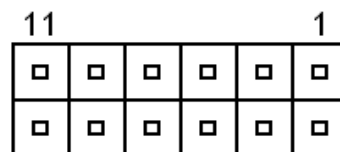
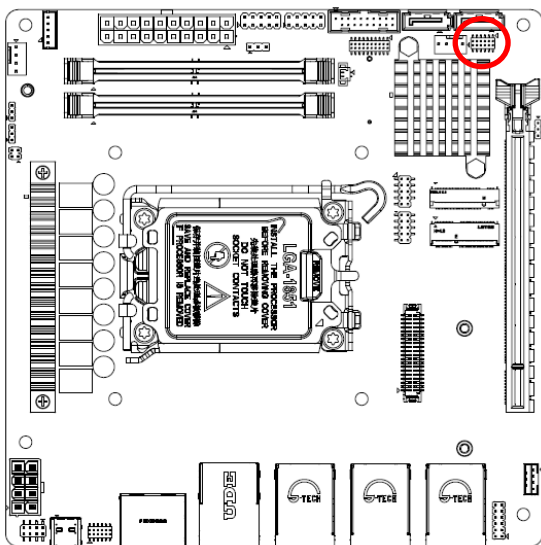

Signal	PIN	PIN	Signal
ESPI_IO0_80P	1	2	+3.3V
ESPI_IO1_80P	3	4	PLT_BUF_RST#
ESPI_IO2_80P	5	6	ESPI_CS#
ESPI_IO3_80P	7	8	ESPI_CLK_80P
NC	9	10	GND
ESPI_RST#	11	12	NC

2.3.15 Front Panel connector (JFPT1)

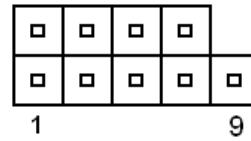
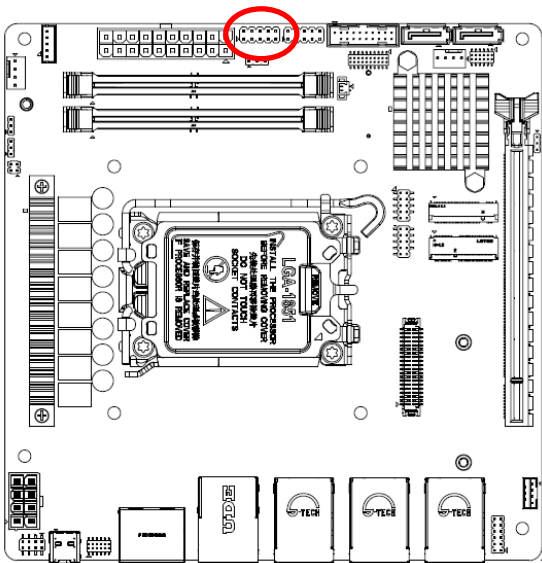

Function	Signal	PIN	PIN	Signal	Function
HDD LED	HDD_LED+	1	2	PWR_LED+	Power
	HDD_LED-	3	4	PWE_LED-	LED
Reset Button	SYS_RST#	5	6	PWRBTN#	Power
	GND	7	8	GND	Button
	NC	9			

2.3.16 CPU fan connector (JC_FAN1)

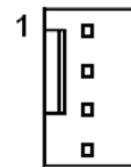
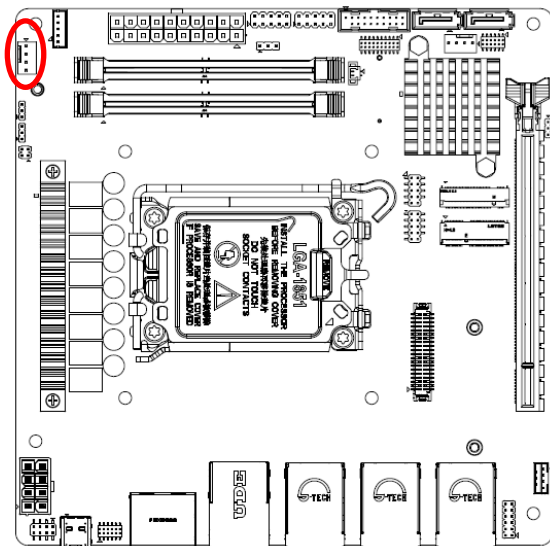

PIN	Signal
1	GND
2	+12V
3	TACH
4	PWM

2.3.17 System fan connector (JS_FAN1)

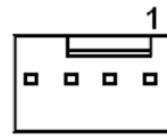
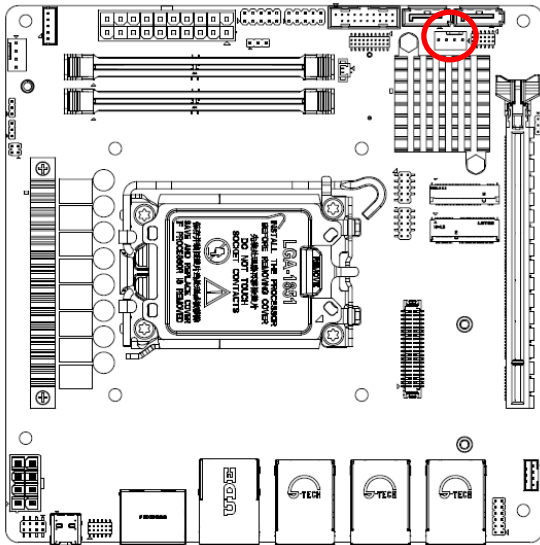

PIN	Signal
1	GND
2	+12V
3	TACH
4	PWM

2.3.18 ATX Power connector (ATXPWR1)

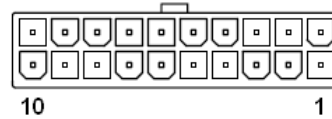
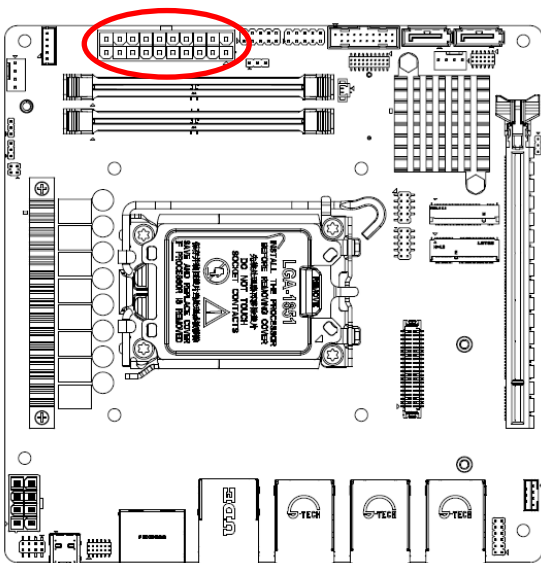

Signal	PIN	PIN	Signal
+3.3V	11	1	+3.3V
NC	12	2	+3.3V
GND	13	3	GND
+V5A_SB	14	4	+5V
GND	15	5	GND
GND	16	6	+5V
GND	17	7	GND
NC	18	8	ATX20_PWROK
+5V	19	9	+V5A_SB
GND	20	10	+12V

2.3.19 ATX Power connector (ATXPWR2)

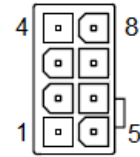
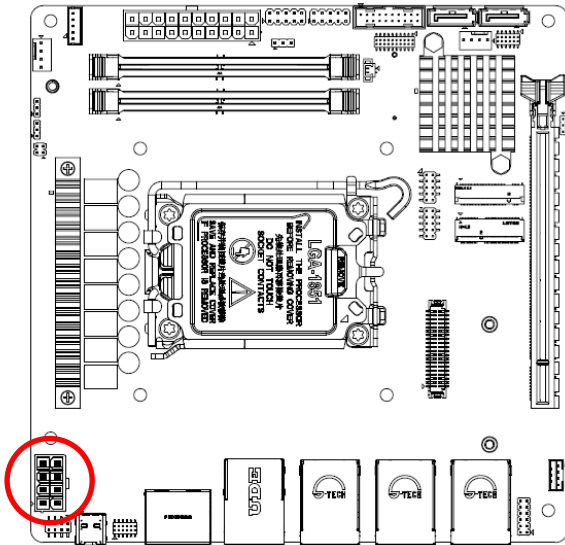

Signal	PIN	PIN	Signal
GND	4	8	+12V
GND	3	7	+12V
GND	2	6	+12V
GND	1	5	+12V

2.3.20 Auxiliary Panel connector (JAUXP1)

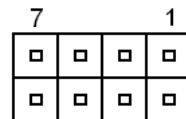
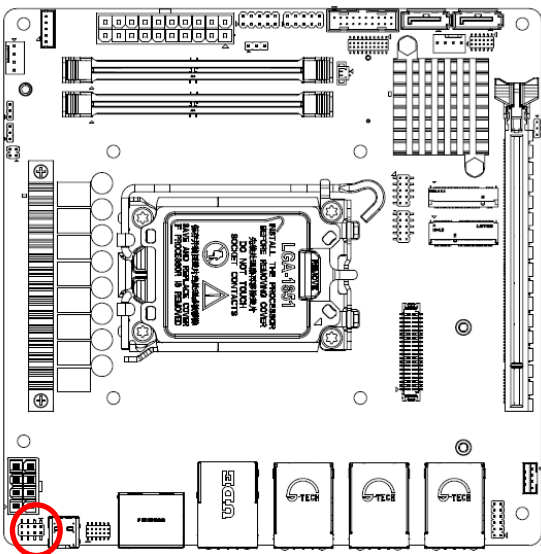

Signal	PIN	PIN	Signal
GND	8	7	FRONT_LAN4_ACT
GND	6	5	FRONT_LAN3_ACT
GND	4	3	FRONT_LAN2_ACT
GND	2	1	FRONT_LAN1_ACT

2.3.21 JTCP_SPI_PD connector (JTCP_SPI_PD1)

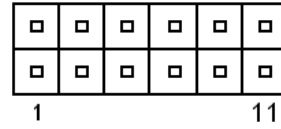
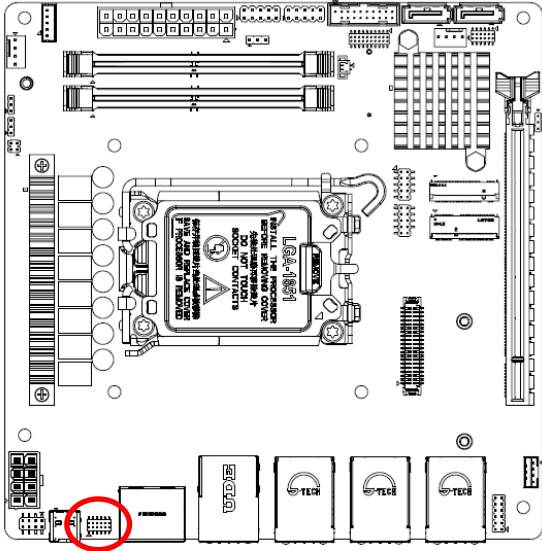

Signal	PIN	PIN	Signal
+1.8V_TCP0_SPI	1	2	GND
TCP0_EE_CS#	3	4	TCP0_EE_CLK
TCP0_EE_DO	5	6	TCP0_EE_DI
+3.3V_PD_LDO	7	8	PD_SML_CLK
EEPROM_I2C_SCL	9	10	PD_SML_DAT
EEPROM_I2C_SDA	11	12	PD_PMC_ALERT#

2.3.22 BIOS SPI connector (JSPI1)

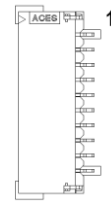
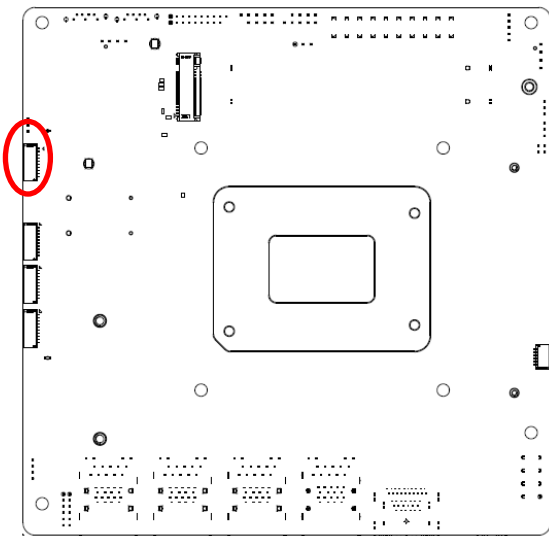

Signal	PIN
EC_SMDAT_DEBUG	1
EC_SMCLK_DEBUG	2
BIOS_WP#	3
BIOS_HOLD#	4
SPF_BIOS_MOSI	5
SPF_BIOS_MISO	6
SPF_BIOS_CLK	7
SPF_BIOS_CS0#	8
GND	9
+V3.3A_SPI	10

2.3.23 PMBus connector (JPC1)

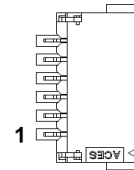
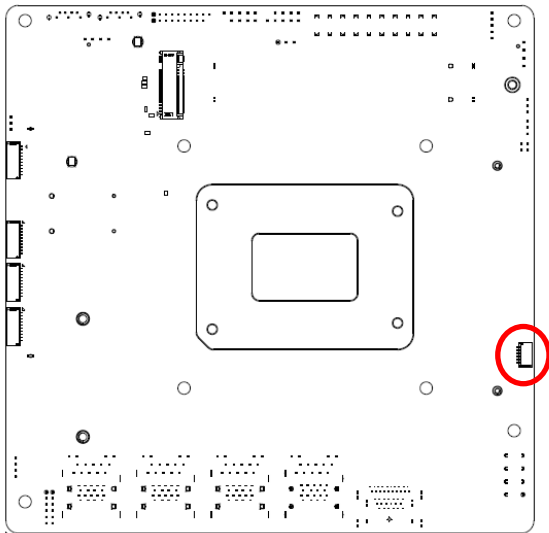

PIN	Signal
6	+3.3V
5	NC
4	VCCCORE_PMSCL
3	GND
2	VCCCORE_PMSDA
1	VCCCORE_nPMALEERT

2.3.24 Serial Port connector (COM3/4/5)

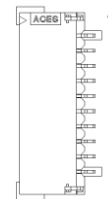
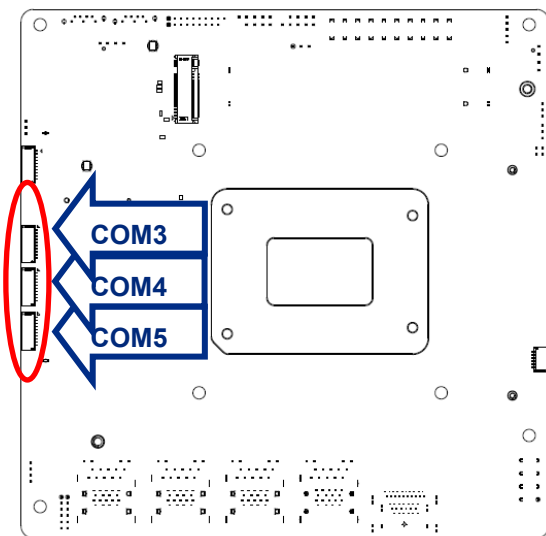

Signal	PIN
DCD#	1
RXD	2
TXD	3
DTR#	4
GND	5
DSR#	6
RTS#	7
CTS#	8
RI#	9
NC	10

EMX-W880P User's Manual

2.3.25 Speaker connector (JSPK1)

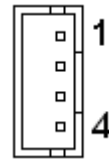
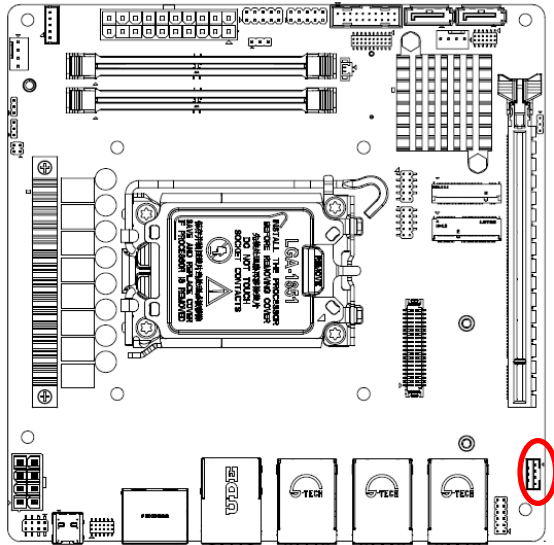

PIN	Signal
1	SPK_L+
2	SPK_L-
3	SPK_R+
4	SPK_R-

2.3.26 LVDS/eDP Connector (JLVDS1)

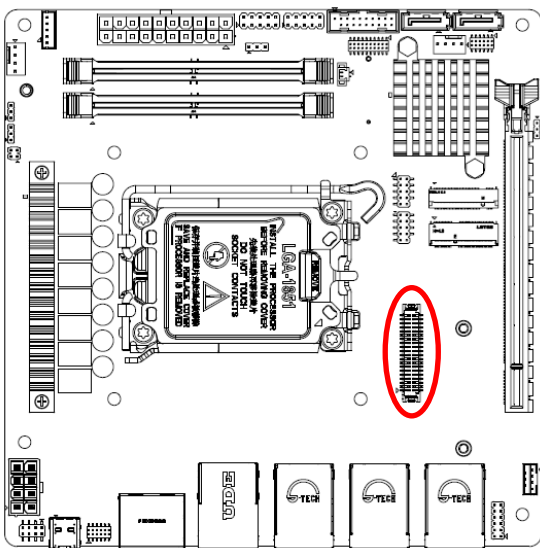

Signal	PIN	PIN	Signal
+12V	39	40	+12V
GND	37	38	GND
LVDS_CLK2N	35	36	LVDS_CLK1N/eDPAUXN
LVDS_CLK2P	33	34	LVDS_CLK1P/eDPAUXP
GND	31	32	GND
LVDS_DATAN7	29	30	LVDS_DATAN6
LVDS_DATAP7	27	28	LVDS_DATAP6
GND	25	26	GND
LVDS_DATAN5	23	24	LVDS_DATAN4
LVDS_DATAP5	21	22	LVDS_DATAP4
GND	19	20	GND
LVDS_DATAN3	17	18	LVDS_DATAN2/eDPN0
LVDS_DATAP3	15	16	LVDS_DATAP2/eDPP0
GND	13	14	GND
LVDS_DATAN1/eDPN1	11	12	LVDS_DATAN0
LVDS_DATAP1/eDPP1	9	10	LVDS_DATAP0/eDP_HPDP
GND	7	8	GND
+3.3V	5	6	+5V
+3.3V	3	4	+5V
+3.3V	1	2	+5V

3. Drivers Installation

All the drivers are available on Avalue Downloads Area (<https://www.avaluetech.com/en/support/download>). Type the model name and press Enter to find all the relevant software, utilities, and documentation.

Chipset **1** Audio **2** Graphics **1** LAN **1** Other Driver **3** ME **1**

Chipset

Total **1** Files

No.	Release Date	Title, Description	Operating System	Download
01	2025-05-09	Intel MTL Chipset driver 10.1.19627.8423 Intel MTL Chipset driver 10.1.19627.8423	Windows 11 64bit	

Audio

Total **2** Files

No.	Release Date	Title, Description	Operating System	Download
01	2025-05-09	Realtek Audio Driver 9721.1 Realtek Audio Driver 9721.1	Windows 11 64bit	
02	2025-05-09	Intel(R)_SST_MTL_v20.40.10915.2 Intel(R)_SST_MTL_v20.40.10915.2	Windows 11 64bit	



Note: Installation procedures and screen shots in this section are for your reference and may not be exactly the same as shown on your screen.

3.1 Install Chipset Driver

All drivers can be found on the Avalue Official Website:

<http://www.avalue.com>



Note: The installation procedures and screen shots in this section are based on Windows 11 operation system. If the warning message appears while the installation process, click Continue to go on.

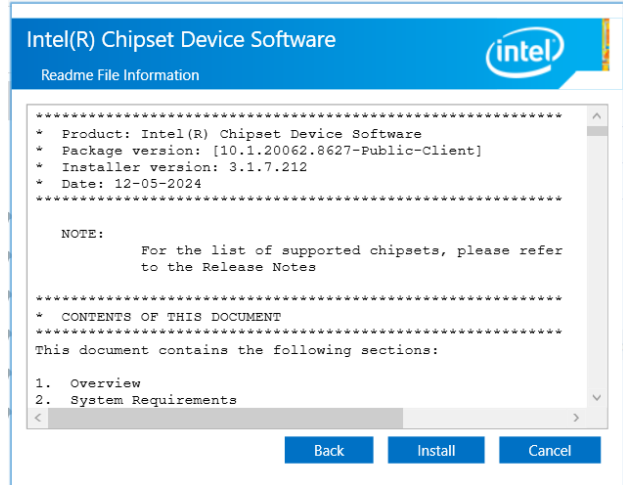

Step 3. Click **Install**.

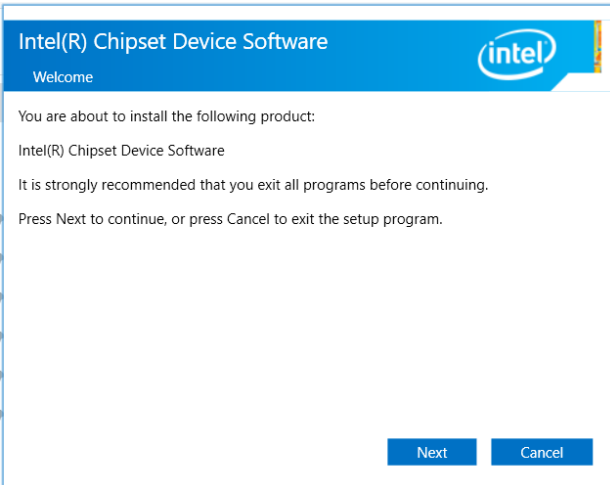

Step1. Click **Accept**.

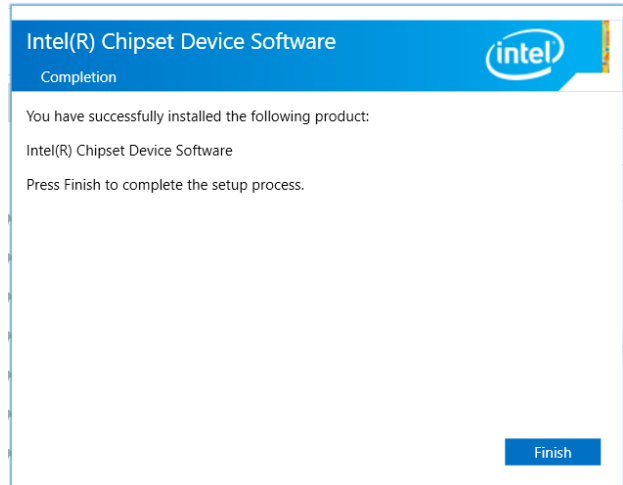

Step 4. Click **Finish** to complete setup.

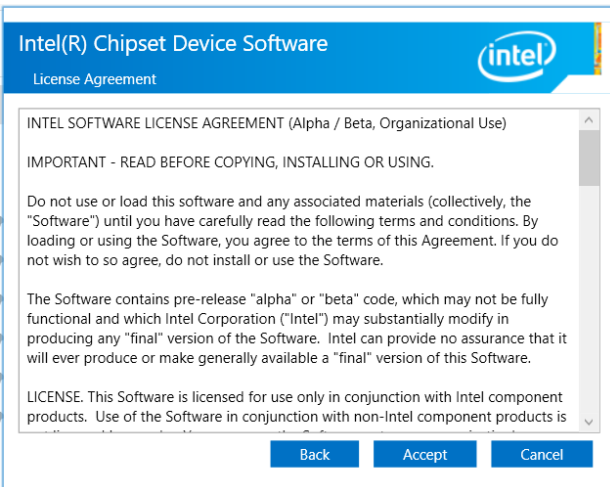

Step 2. Click **Accept**.

3.2 Install Graphics Driver

All drivers can be found on the Avalue Official Website:

<http://www.avalue.com>



Note: The installation procedures and screen shots in this section are based on Windows 11 operation system. If the warning message appears while the installation process, click Continue to go on.

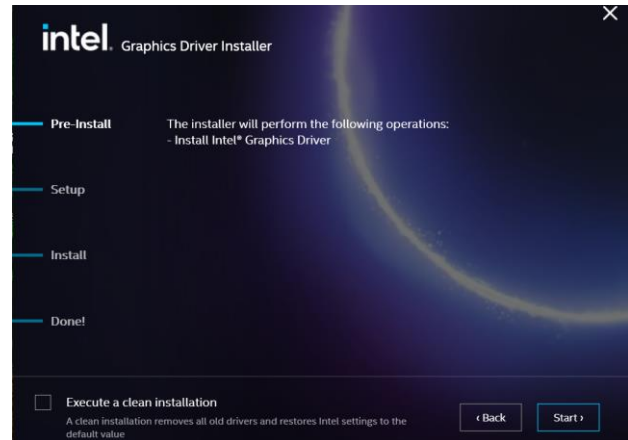

Step 3. Click Start.



Step 1. Click Begin installation.

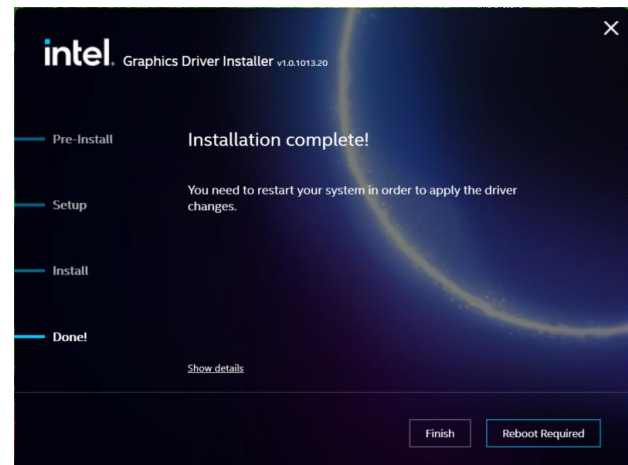

Step 4. Click Finish to complete setup.

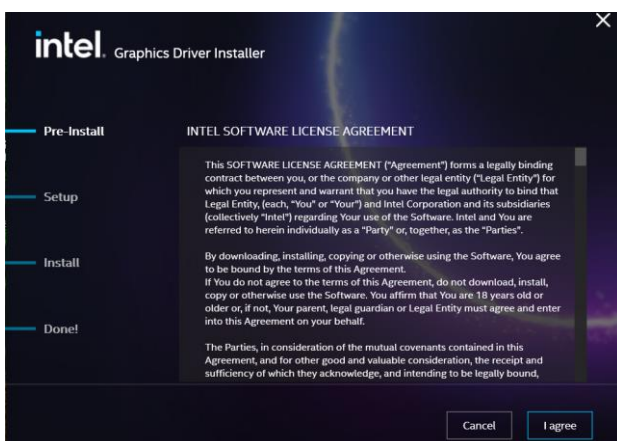

Step 2. Click I agree.

3.3 Install LAN Driver

All drivers can be found on the Avalue Official Website:

<http://www.avalue.com>



Note: The installation procedures and screen shots in this section are based on Windows 11 operation system. If the warning message appears while the installation process, click Continue to go on.

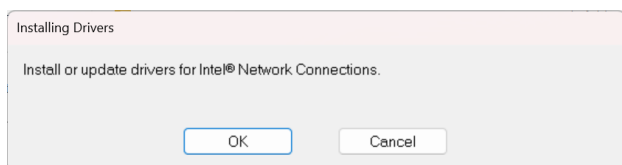

Step 1. Click **OK** to continue setup.

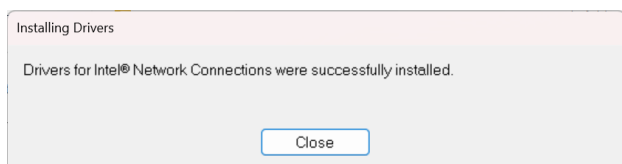

Step 2. Click **OK** to continue setup.

3.4 Install ME Driver

All drivers can be found on the Avalue Official Website:

<http://www.avalue.com>



Note: The installation procedures and screen shots in this section are based on Windows 11 operation system. If the warning message appears while the installation process, click Continue to go on.

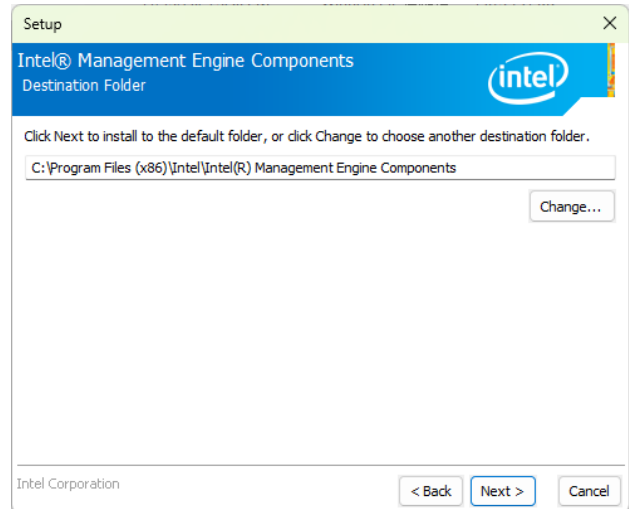

Step 3. Click Next.

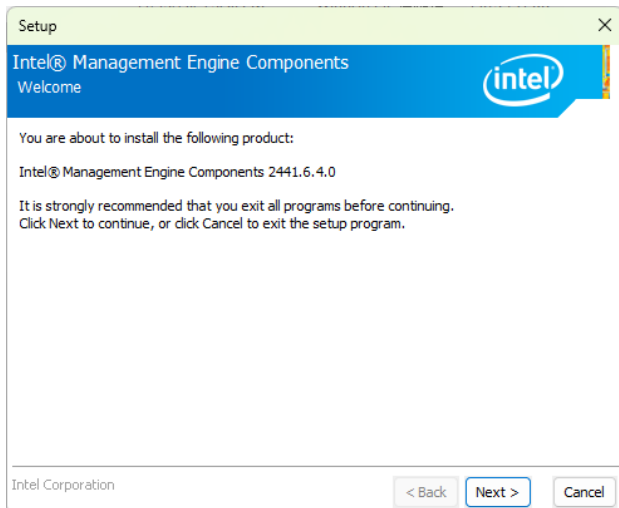

Step 1. Click Next to continue setup.

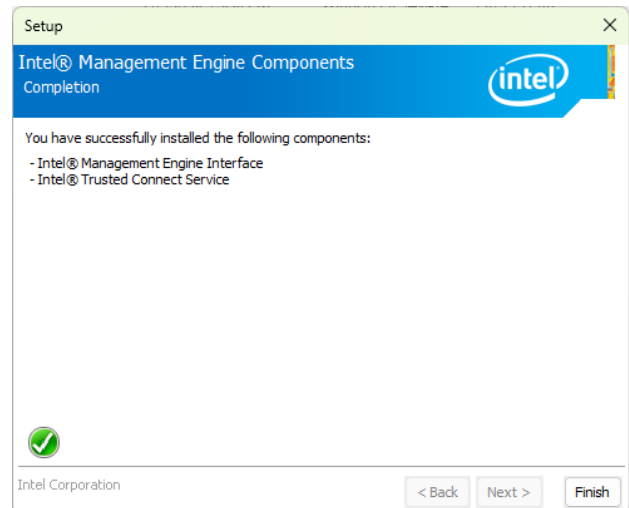

Step 4. Click Finish to complete the setup.

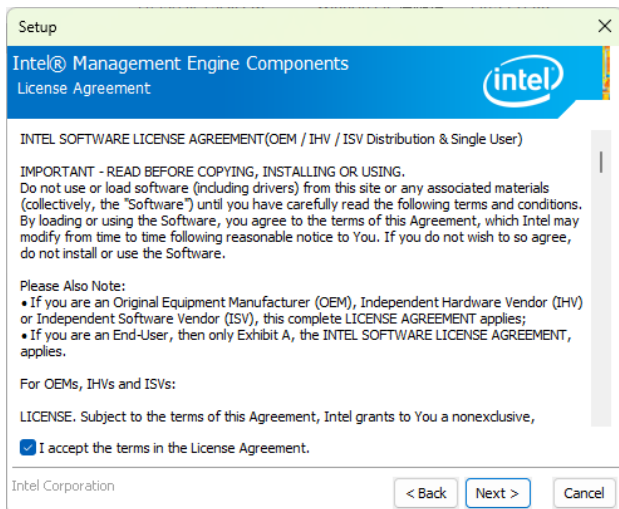

Step 2. Click Next.

3.5 Install Audio Driver

All drivers can be found on the Avalue Official Website:

<http://www.avalue.com>



Note: The installation procedures and screen shots in this section are based on Windows 11 operation system. If the warning message appears while the installation process, click Continue to go on.

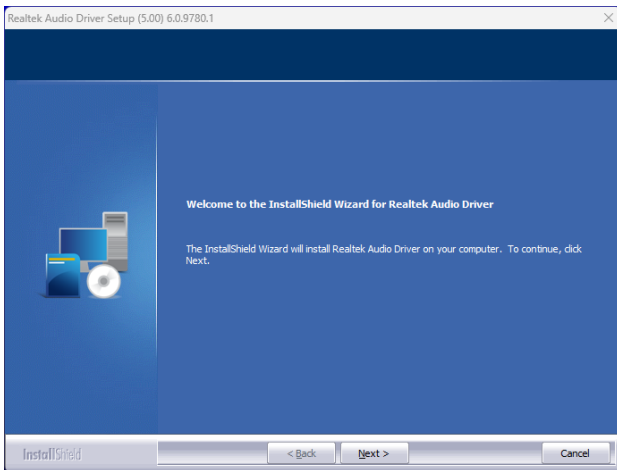

Step 1. Click **Next** to continue setup.

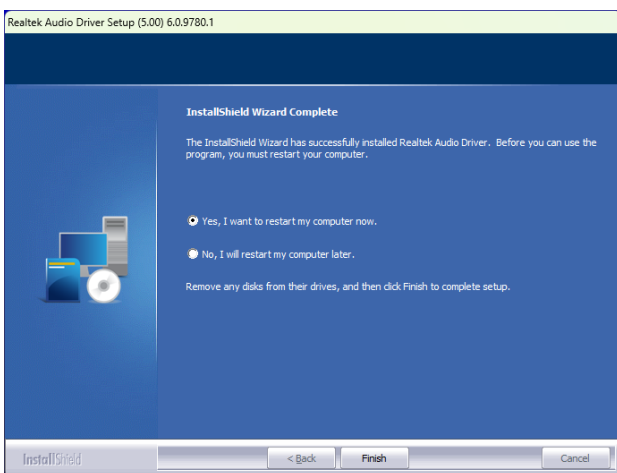

Step 2. Click **Finish** to complete the setup.

3.6 Install GNA Driver

All drivers can be found on the Avalue Official Website:

<http://www.avalue.com>



Note: The installation procedures and screen shots in this section are based on Windows 11 operation system. If the warning message appears while the installation process, click Continue to go on.

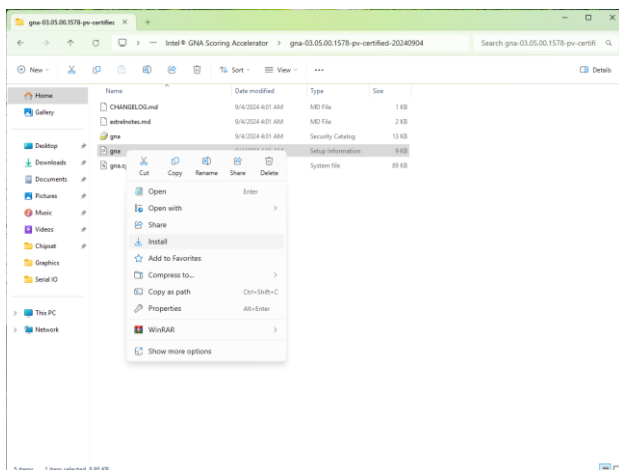

Step 1. Click **Install** continue setup.

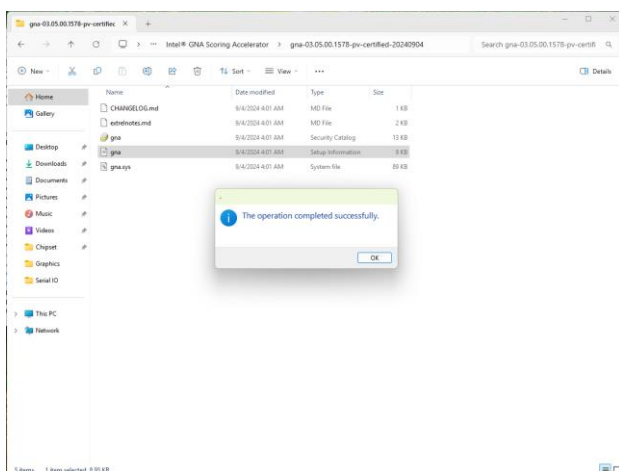

Step 2. Click **OK**.

3.7 Install NPU Driver

All drivers can be found on the Avalue Official Website:

<http://www.avalue.com>



Note: The installation procedures and screen shots in this section are based on Windows 11 operation system. If the warning message appears while the installation process, click Continue to go on.

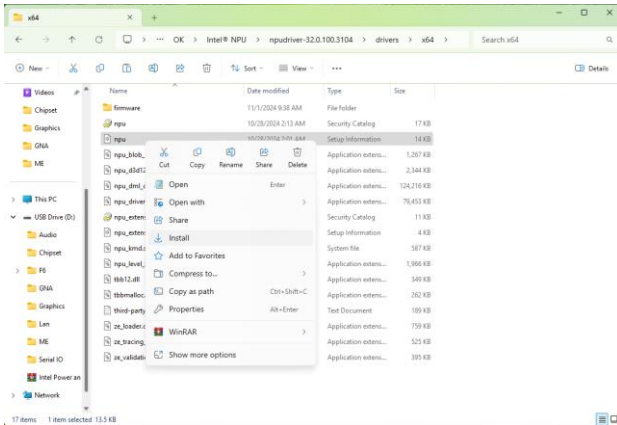

Step 1. Click **Install** continue setup.

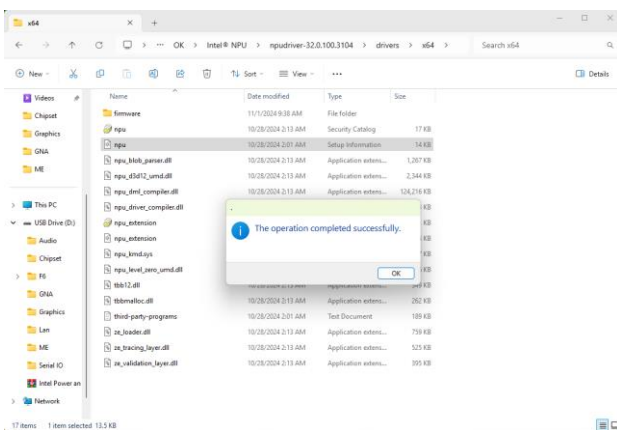

Step 2. Click **OK**.

3.8 Install RAID Driver

All drivers can be found on the Avalue Official Website:

<http://www.avalue.com>



Note: The installation procedures and screen shots in this section are based on Windows 11 operation system. If the warning message appears while the installation process, click Continue to go on.

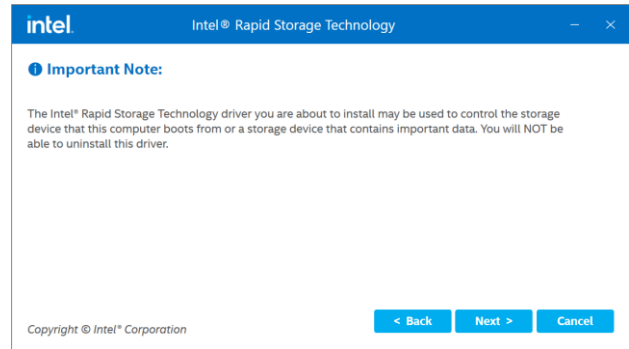

Step 3. Click Next.

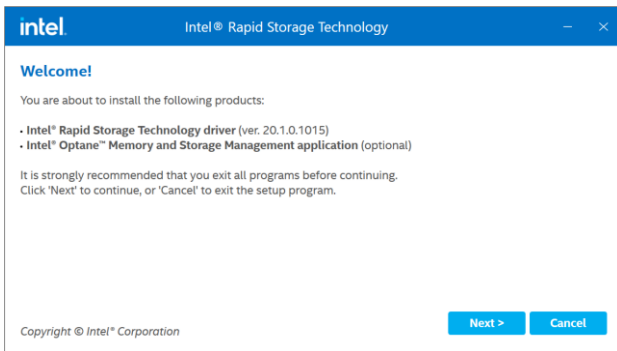

Step 1. Click Next to continue setup.

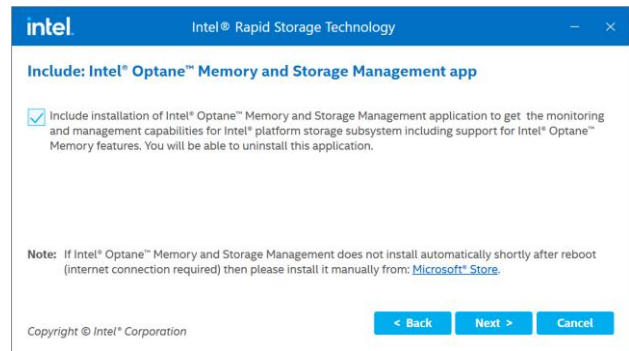

Step 4. Click Next.

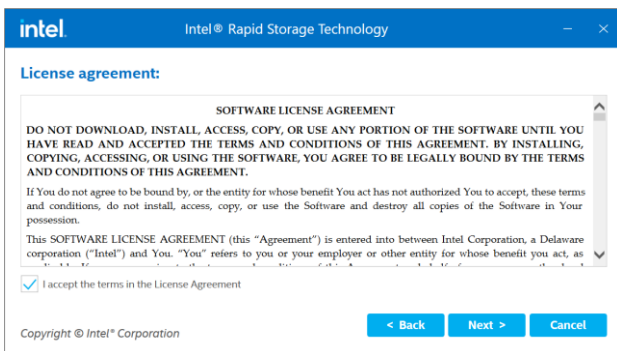

Step 2. Click Next.

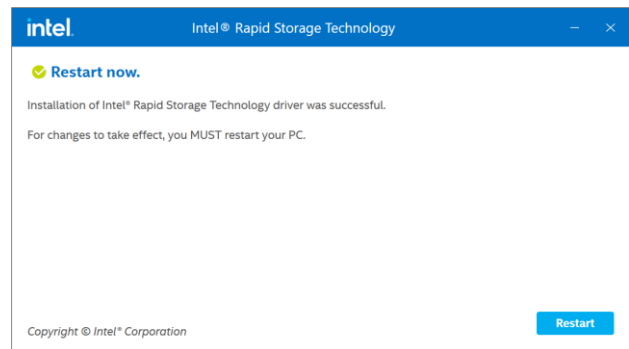

Step 5. Click Restart to complete the setup.

3.9 Install Serial IO Driver

All drivers can be found on the Avalue Official Website:

<http://www.avalue.com>



Note: The installation procedures and screen shots in this section are based on Windows 11 operation system. If the warning message appears while the installation process, click Continue to go on.

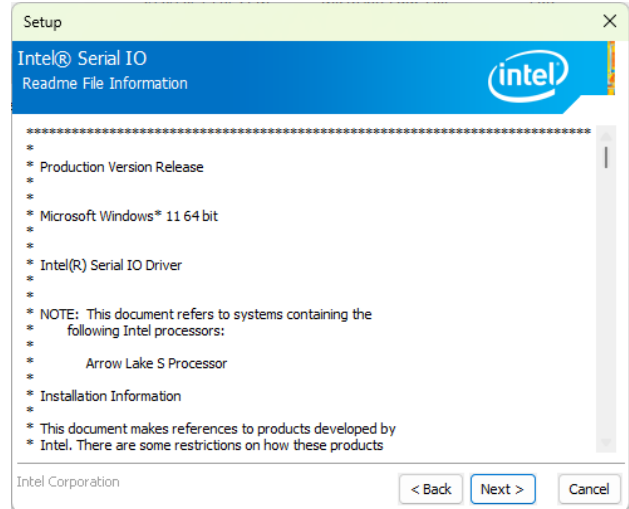

Step 3. Click Next.

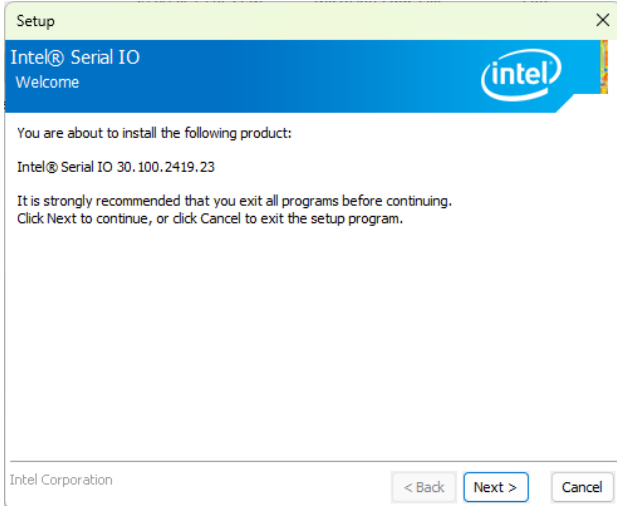

Step 1. Click Next to continue setup.

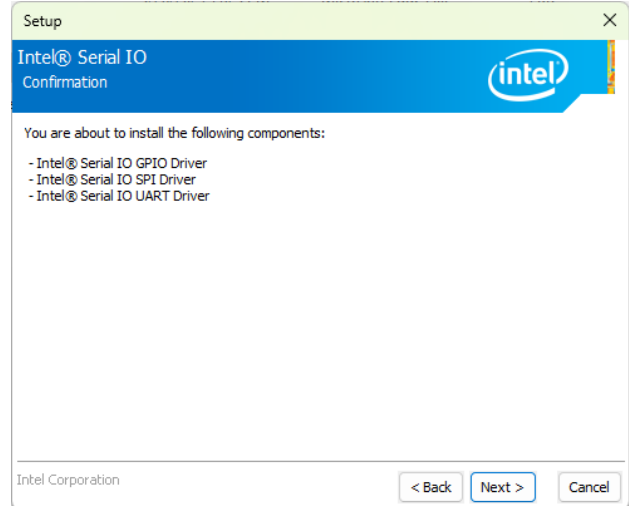

Step 4. Click Next.

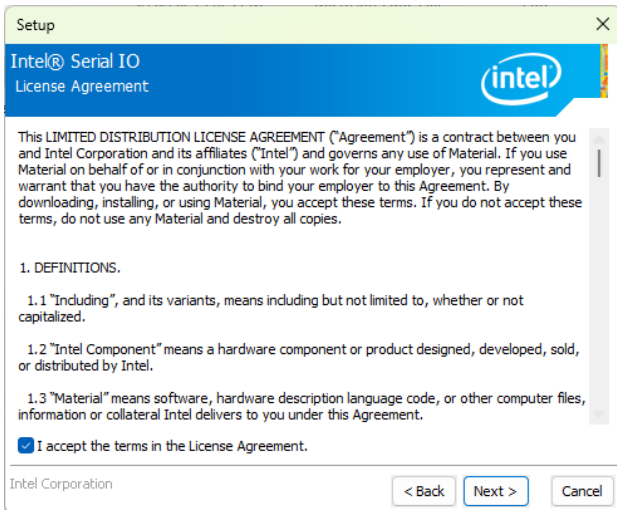

Step 2. Click Next.

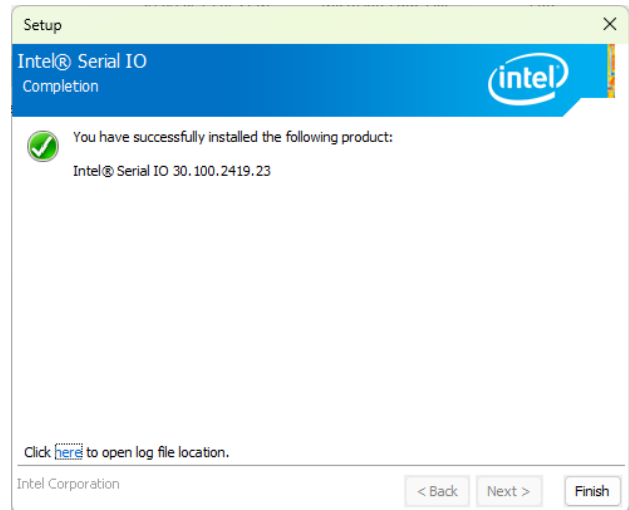

Step 5. Click Finish to complete the setup.

4. BIOS Setup

4.1 Introduction

The BIOS setup program allows users to modify the basic system configuration. In this following chapter will describe how to access the BIOS setup program and the configuration options that may be changed.

4.2 Starting Setup

AMI BIOS™ is immediately activated when you first power on the computer. The BIOS reads the system information contained in the NVRAM and begins the process of checking out the system and configuring it. When it finishes, the BIOS will seek an operating system on one of the disks and then launch and turn control over to the operating system.

While the BIOS is in control, the Setup program can be activated in one of two ways:

By pressing <ESC> or immediately after switching the system on, or

By pressing the < ESC> or key when the following message appears briefly at the left-top of the screen during the POST (Power On Self Test).

Press <ESC> or to enter SETUP

If the message disappears before you respond and you still wish to enter Setup, restart the system to try again by turning it OFF then ON or pressing the "RESET" button on the system case. You may also restart by simultaneously pressing <Ctrl>, <Alt>, and <Delete> keys.

4.3 Using Setup

In general, you use the arrow keys to highlight items, press <Enter> to select, use the PageUp and PageDown keys to change entries, press <F1> for help and press <Esc> to quit. The following table provides more detail about how to navigate in the Setup program using the keyboard.

Button	Description
↑	Move to previous item
↓	Move to next item
←	Move to the item in the left hand
→	Move to the item in the right hand
Esc key	Main Menu -- Quit and not save changes into NVRAM Status Page Setup Menu and Option Page Setup Menu -- Exit current page and return to Main Menu
+ key	Increase the numeric value or make changes
- key	Decrease the numeric value or make changes
F1 key	General help, only for Status Page Setup Menu and Option Page Setup Menu
F2 key	Previous Values
F3 key	Optimized defaults
F4 key	Save & Exit Setup

- **Navigating Through The Menu Bar**

Use the left and right arrow keys to choose the menu you want to be in.



Note: Some of the navigation keys differ from one screen to another.

- **To Display a Sub Menu**

Use the arrow keys to move the cursor to the sub menu you want. Then press <Enter>. A “>” pointer marks all sub menus.

4.4 Getting Help

Press F1 to pop up a small help window that describes the appropriate keys to use and the possible selections for the highlighted item. To exit the Help Window press <Esc> or the <Enter> key again.

4.5 In Case of Problems

If, after making and saving system changes with Setup, you discover that your computer no longer is able to boot, the AMI BIOS supports an override to the NVRAM settings which resets your system to its defaults.

The best advice is to only alter settings which you thoroughly understand. To this end, we strongly recommend that you avoid making any changes to the chipset defaults. These defaults have been carefully chosen by both BIOS Vendor and your systems manufacturer to provide the absolute maximum performance and reliability. Even a seemingly small change to the chipset setup has the potential for causing you to use the override.

4.6 BIOS setup

Once you enter the Aptio Setup Utility, the Main Menu will appear on the screen. The Main Menu allows you to select from several setup functions and exit choices. Use the arrow keys to select among the items and press <Enter> to accept and enter the sub-menu.

4.6.1 Main Menu

This section allows you to record some basic hardware configurations in your computer and set the system clock.

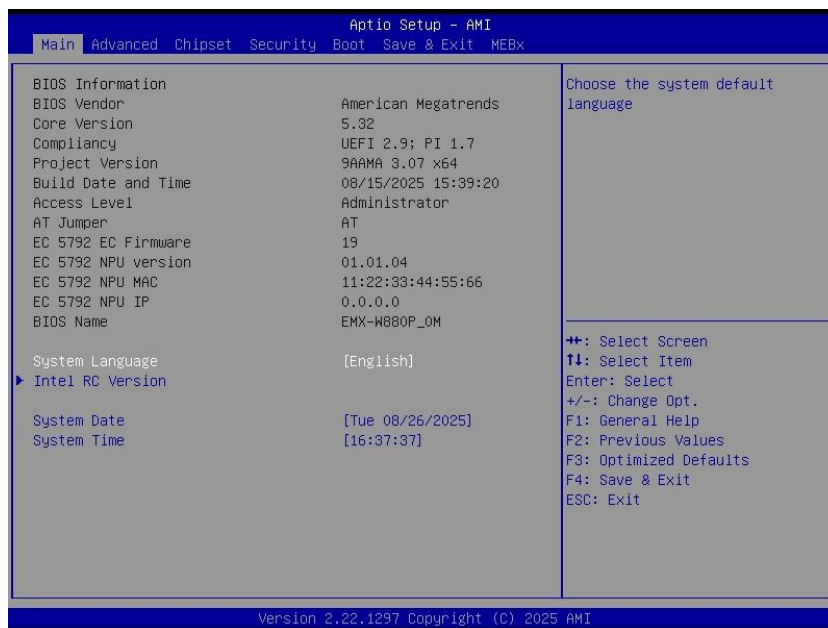

4.6.1.1 System Language

This option allows choosing the system default language.

EMX-W880P User's Manual

4.6.1.2 System Date

Use the system date option to set the system date. Manually enter the month, day and Year.

4.6.1.3 System Time

Use the system time option to set the system time. Manually enter the hours, minutes and seconds.



Note: The BIOS setup screens shown in this chapter are for reference purposes only, and may not exactly match what you see on your screen. Visit the Avalue website (www.avalue.com) to download the latest product and BIOS information.

4.6.2 Advanced Menu

This section allows you to configure your CPU and other system devices for basic operation through the following sub-menus.

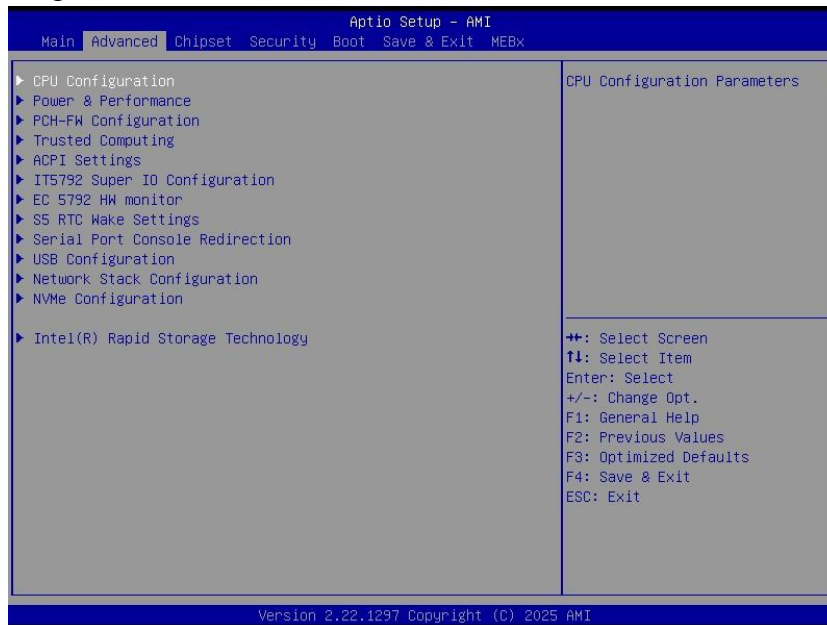

4.6.2.1 CPU Configuration



Item	Options	Description
Intel (VMX) Virtualization Technology	Disable, Enable[Default]	When enabled, a VMM can utilize the additional hardware capabilities provided by Vanderpool Technology.
Active Performance-cores	All	Number of P-cores to enable in each processor package. Note: Number of Cores and E-cores are looked at together. When both are {0,0}, Pcode will enable all cores.
Active Efficient-cores	All	Number of E-cores to enable in each processor package. Note: Number of Cores and E-cores are looked at together. When both are {0,0}, Pcode will enable all cores.

4.6.2.1.1 Efficient-core Information

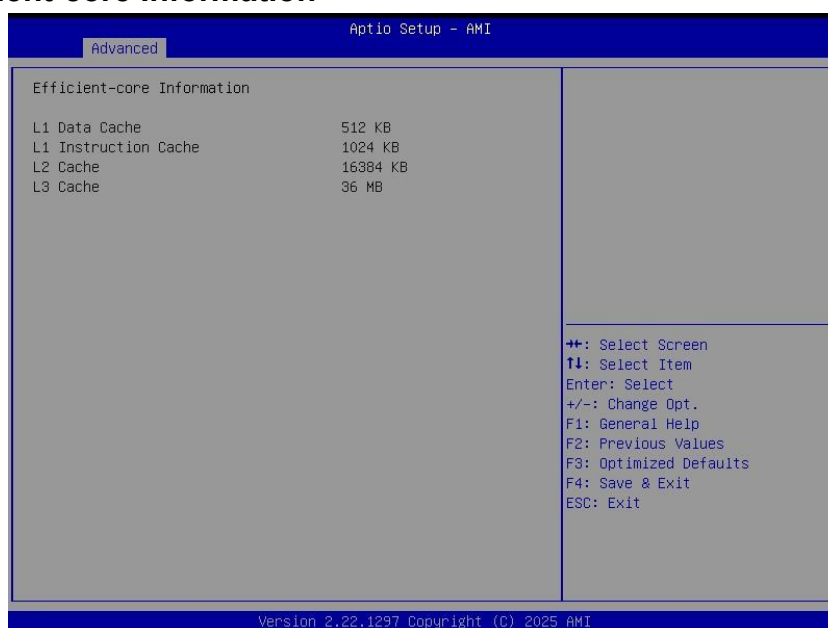

EMX-W880P User's Manual

4.6.2.2 Power & Performance



4.6.2.2.1 CPU - Power Management Control

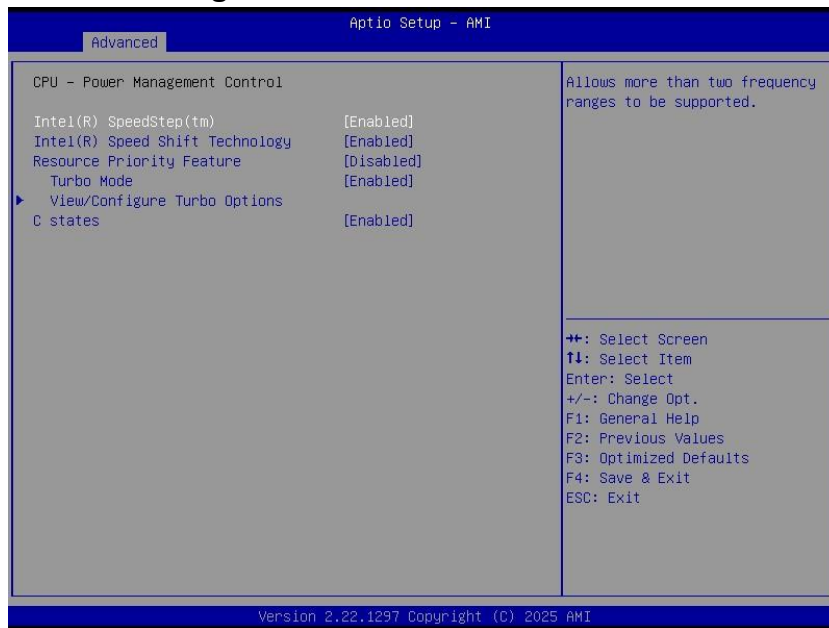

Item	Options	Description
Intel(R) SpeedStep(tm)	Disabled, Enabled [Default]	Allows more than two frequency ranges to be supported.
Intel(R) Speed Shift Technology	Disabled, Enabled [Default]	Enable/Disable Intel® Speed Shift Technology support. Enabling will expose the CPPC v2 interface to allow for hardware controlled P-states.
Resource Priority Feature	Disabled [Default] , Enabled	Enable/Disable Resource Priority Feature support.

Turbo Mode	Disabled, Enabled[Default]	Enable/Disable processor Turbo Mode.
C states	Disabled, Enabled[Default]	Enable/Disable CPU Power Management. Allows CPU to go to C states when it's not 100% utilized.

4.6.2.2.1.1 View/Configure Turbo Options

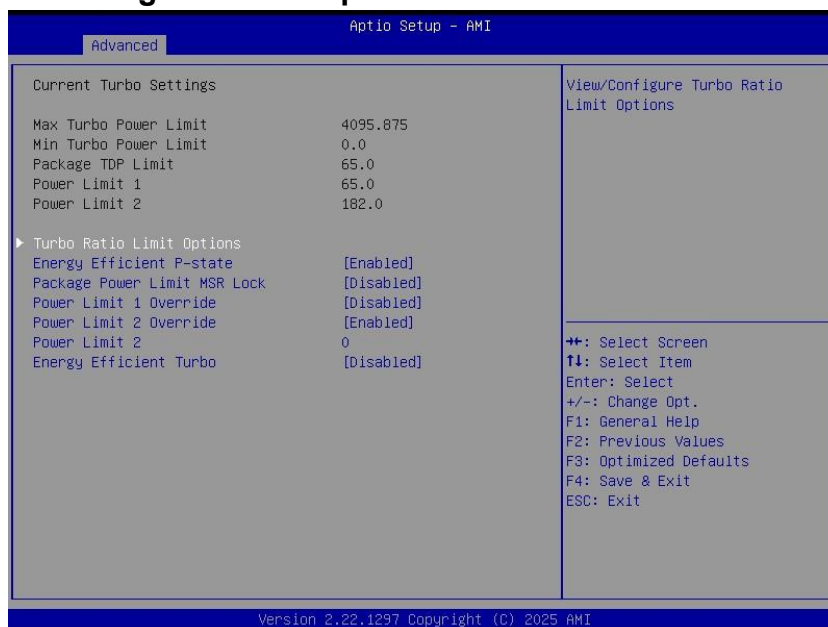

Item	Options	Description
Energy Efficient P-state	Disabled, Enabled[Default]	Enable/Disable Energy Efficient P-state feature. When set to 0, will disable access to ENERGY_PERFORMANCE_BIAS MSR and CPUID Function will read 0 indicating no support for Energy Efficient policy setting. When set to 1 will enable access to ENERGY_PERFORMANCE_BIAS MSR and CPUID Function will read 1 indicating Energy Efficient policy setting is supported.
Package Power Limit MSR Lock	Disabled[Default], Enabled	Enable/Disable locking of Package Power Limit settings. When enabled, PACKAGE_POWER_LIMIT MSR will be locked and a reset will be required to unlock the register.
Power Limit 1 Override	Disabled[Default], Enabled	Enable/Disable Power Limit 1 override. If this option is disabled, BIOS will program the default values for Power Limit 1 and Power Limit 1 Time Window.
Power Limit 2 Override	Disabled, Enabled[Default]	Enable/Disable Power Limit 2 override. If this option is disabled, BIOS will program the default values for Power Limit 2.
Power Limit 2	0	Power Limit 2 value in Milli Watts. BIOS will round to the nearest 1/8W when programming. If the value is 0, BIOS will program this value as 1.25 * Processor Base Power (TDP). For 12.50W, enter 12500. Processor applies

EMX-W880P User's Manual

		control policies such that the package power does not exceed this limit.
Energy Efficient Turbo	Disabled[Default], Enabled	Enable/Disable Energy Efficient Turbo Feature. This feature will opportunistically lower the turbo frequency to increase efficiency. Recommended only to disable in overclocking situations where turbo frequency must remain constant. Otherwise, leave enabled.

4.6.2.2.1.1 Turbo Ratio Limit Options

The screenshot shows the 'Advanced' menu in 'Aptio Setup - AMI'. The 'Current Turbo Ratio Limit Settings' section lists various core and ratio limits. The right-hand side contains a detailed description of the Performance-core Turbo Ratio Limit Core0 and a list of navigation keys.

Setting	Value
P-core Turbo Ratio Limit Core0 (TRLC)	1
P-core Turbo Ratio Limit Core1 (TRLC)	2
P-core Turbo Ratio Limit Core2 (TRLC)	3
P-core Turbo Ratio Limit Core3 (TRLC)	4
P-core Turbo Ratio Limit Core4 (TRLC)	5
P-core Turbo Ratio Limit Core5 (TRLC)	6
P-core Turbo Ratio Limit Core6 (TRLC)	7
P-core Turbo Ratio Limit Core7 (TRLC)	8
P-core Turbo Ratio Limit Ratio0 (TRLR)	56
P-core Turbo Ratio Limit Ratio1 (TRLR)	56
P-core Turbo Ratio Limit Ratio2 (TRLR)	53

Performance-core Turbo Ratio Limit Core0 defines the core range, the turbo ratio is defined in Turbo Ratio Limit Ratio0. If value is zero, this entry is ignored.

Navigation keys:
 ++: Select Screen
 ↑↓: Select Item
 Enter: Select
 +/-: Change Opt.
 F1: General Help
 F2: Previous Values
 F3: Optimized Defaults
 F4: Save & Exit
 ESC: Exit

Version 2.22.1297 Copyright (C) 2025 AMI

4.6.2.3 PCH-FW Configuration

The screenshot shows the 'Advanced' menu in 'Aptio Setup - AMI'. The 'Configure Management Engine Technology Parameters' section lists various ME firmware and state settings. The right-hand side contains a list of navigation keys.

ME Firmware Version	19.0.0.1854
ME Firmware Mode	Normal Mode
ME Firmware SKU	Corporate SKU
ME Firmware Status 1	0x90000255
ME Firmware Status 2	0x60008100
ME Firmware Status 3	0x00000030
ME Firmware Status 4	0x00000000
ME Firmware Status 5	0x02600000
ME Firmware Status 6	0x00000000
ME State	[Enabled]
Manageability Features State	[Enabled]
AMT BIOS Features	[Enabled]
TPM Device Selection	[dTPM]

Configure Management Engine Technology Parameters

Navigation keys:
 ++: Select Screen
 ↑↓: Select Item
 Enter: Select
 +/-: Change Opt.
 F1: General Help
 F2: Previous Values
 F3: Optimized Defaults
 F4: Save & Exit
 ESC: Exit

Version 2.22.1297 Copyright (C) 2025 AMI

4.6.2.3.1 Firmware Update Configuration



Item	Options	Description
Me FW Image Re-Flash	Disabled [Default] , Enabled	Enable/Disable Me FW Image Re-Flash function.

4.6.2.4 Trusted Computing



Item	Options	Description
Security Device Support	Disabled, Enabled [Default]	Enables or Disables BIOS support for security device. O.S. will not show Security Device. TCG EFI protocol and INT1A interface will not be available.

4.6.2.5 ACPI Settings

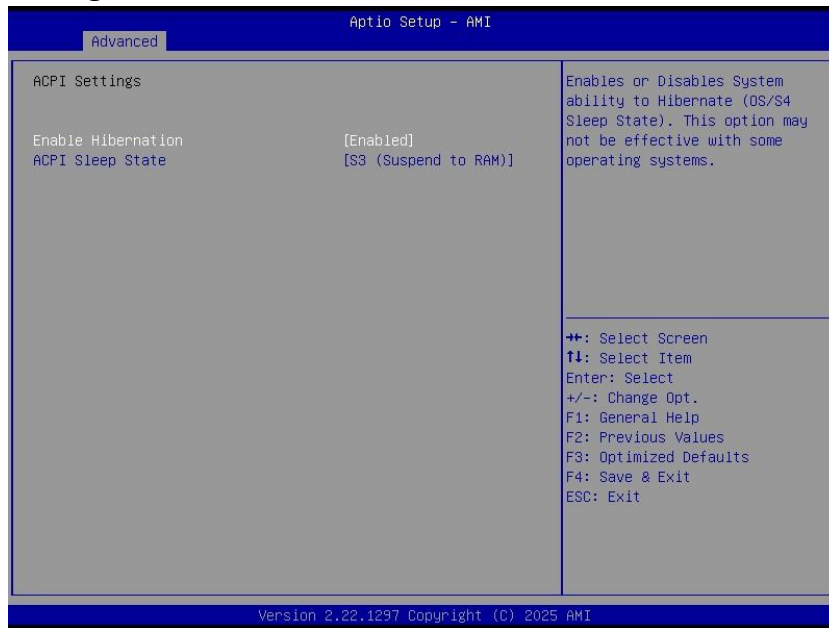

Item	Options	Description
Enable Hibernation	Disabled Enabled[Default],	Enables or Disables System ability to Hibernate (OS/S4 Sleep State). This option may not be effective with some Operating System.
ACPI Sleep State	Suspend Disabled, S3 (Suspend to RAM)[Default]	Select the highest ACPI sleep state the system will enter when the SUSPEND button is pressed.

4.6.2.6 IT5792 Super IO Configuration

You can use this item to set up or change the IT5792 Super IO configuration for serial ports. Please refer to 4.6.2.6.1~ 4.6.2.6.6 for more information.

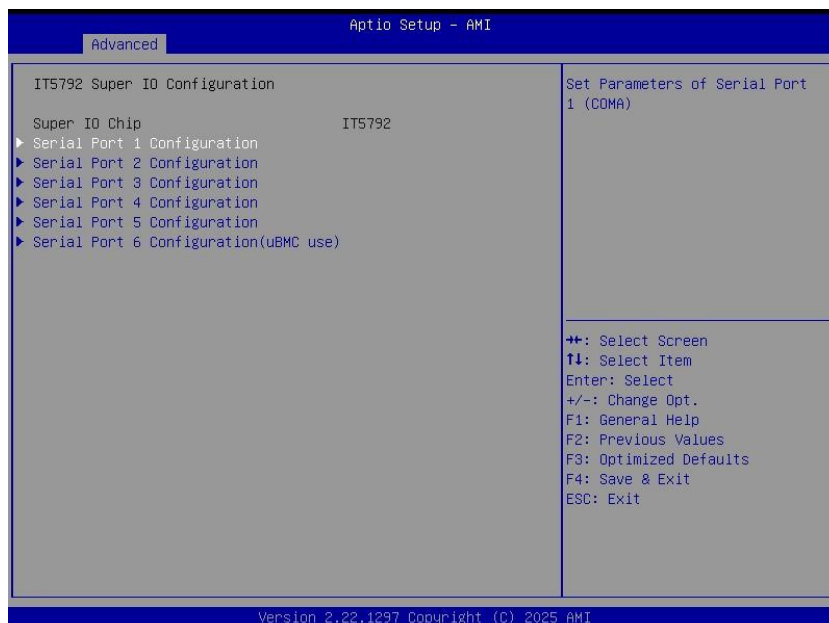

Item	Description
Serial Port 1 Configuration	Set Parameters of Serial Port 1 (COMA).
Serial Port 2 Configuration	Set Parameters of Serial Port 2 (COMB).
Serial Port 3 Configuration	Set Parameters of Serial Port 3 (COMC).
Serial Port 4 Configuration	Set Parameters of Serial Port 4 (COMD).
Serial Port 5 Configuration	Set Parameters of Serial Port 5 (COME).
Serial Port 6 Configuration (uBMC use)	Set Parameters of Serial Port 6 (COMF).

4.6.2.6.1 Serial Port 1 Configuration



Item	Option	Description
Serial Port	Enabled[Default], Disabled	Enable or Disable Serial Port (COM).
UART 232 422 485	UART 485 UART 422 UART 232[Default],	Change the Serial Port as RS232/422/485.
INT_EXT R Mode	Auto[Default], INT + EXT R INT R EXT R Non INT + EXT R	Change the INT + EXT as Auto/INT/EXT

EMX-W880P User's Manual

4.6.2.6.2 Serial Port 2 Configuration

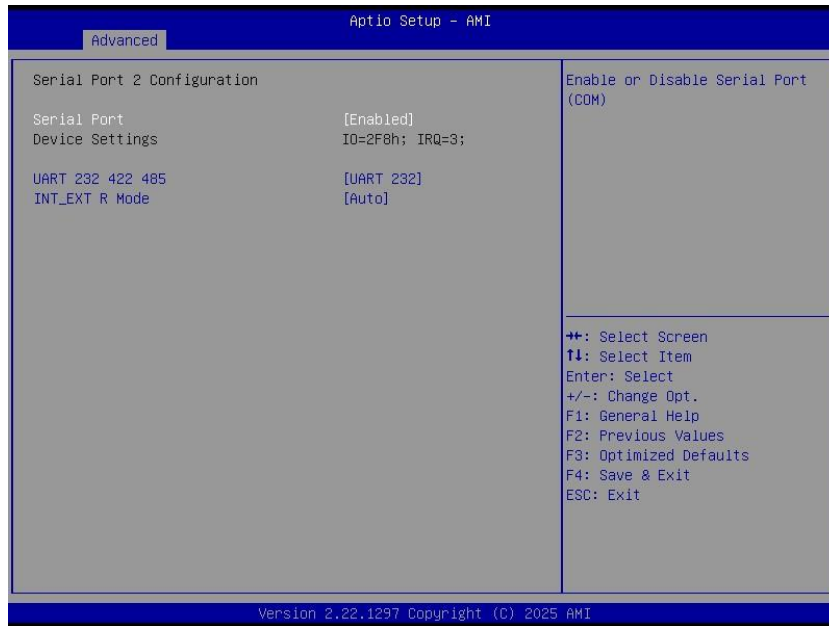

Item	Option	Description
Serial Port	Enabled[Default], Disabled	Enable or Disable Serial Port (COM).
UART 232 422 485	UART 485 UART 422 UART 232[Default],	Change the Serial Port as RS232/422/485.
INT_EXT R Mode	Auto[Default], INT + EXT R INT R EXT R Non INT + EXT R	Change the INT + EXT as Auto/INT/EXT

4.6.2.6.3 Serial Port 3 Configuration

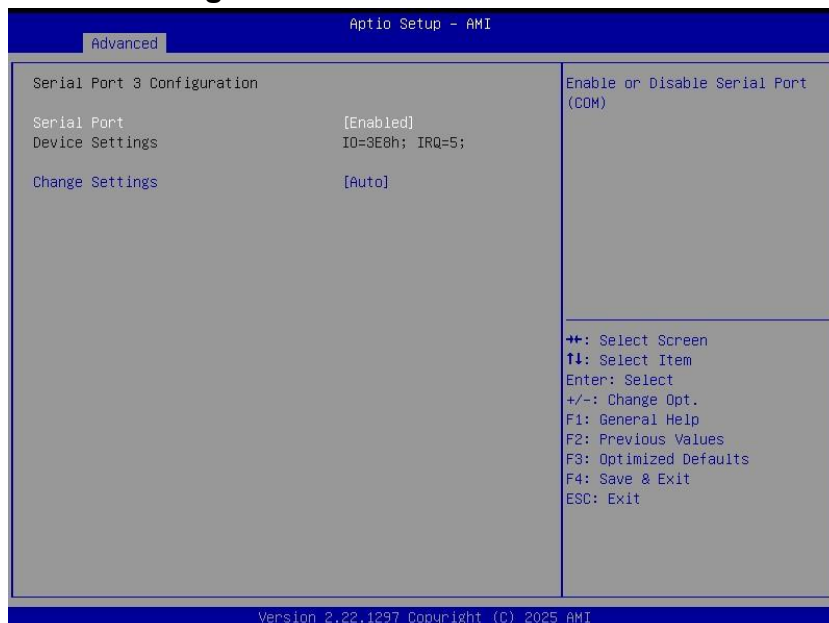

Item	Option	Description
Serial Port	Enabled[Default], Disabled	Enable or Disable Serial Port (COM).
Change Settings	Auto[Default], IO=3E8h; IRO=7; IO=3E8h; IRO=3,4,5,6,7,9,10,11,12 IO=2E8h; IRO=3,4,5,6,7,9,10,11,12 IO=2F0h; IRO=3,4,5,6,7,9,10,11,12 IO=2E0h; IRO=3,4,5,6,7,9,10,11,12	Select an optimal settings for Super IO Device

4.6.2.6.4 Serial Port 4 Configuration



Item	Option	Description
Serial Port	Enabled[Default], Disabled	Enable or Disable Serial Port (COM).
Change Settings	Auto[Default], IO=3E8h; IRO=7; IO=3E8h; IRO=3,4,5,6,7,9,10,11,12 IO=2E8h; IRO=3,4,5,6,7,9,10,11,12 IO=2F0h; IRO=3,4,5,6,7,9,10,11,12 IO=2E0h; IRO=3,4,5,6,7,9,10,11,12	Select an optimal settings for Super IO Device

4.6.2.6.5 Serial Port 5 Configuration

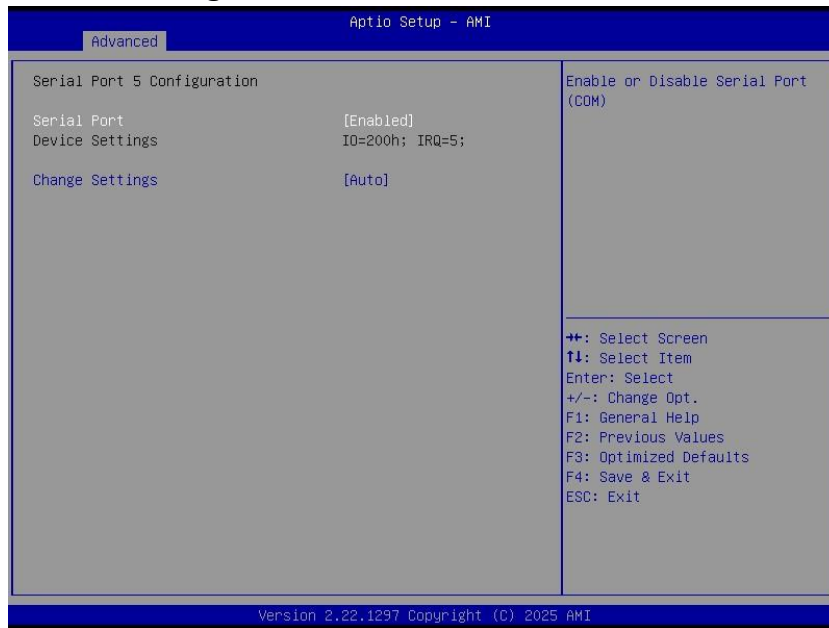

Item	Option	Description
Serial Port	Enabled[Default], Disabled	Enable or Disable Serial Port (COM).
Change Settings	Auto[Default], IO=3E8h; IRO=7; IO=3E8h; IRO=3,4,5,6,7,9,10,11,12 IO=2E8h; IRO=3,4,5,6,7,9,10,11,12 IO=2F0h; IRO=3,4,5,6,7,9,10,11,12 IO=2E0h; IRO=3,4,5,6,7,9,10,11,12	Select an optimal settings for Super IO Device

4.6.2.6.6 Serial Port 6 Configuration

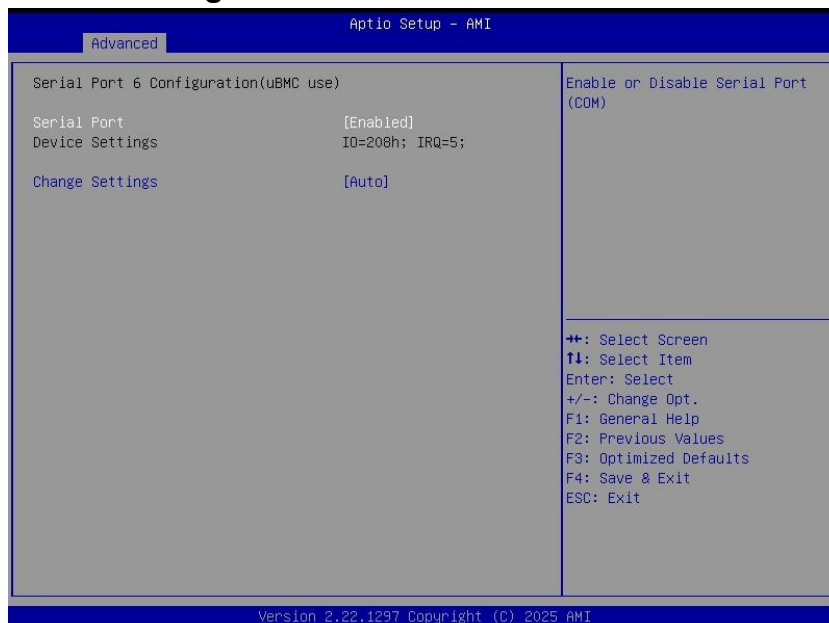

Item	Option	Description
Serial Port	Enabled[Default], Disabled	Enable or Disable Serial Port (COM).
Change Settings	Auto[Default], IO=3E8h; IRO=7; IO=3E8h; IRO=3,4,5,6,7,9,10,11,12 IO=2E8h; IRO=3,4,5,6,7,9,10,11,12 IO=2F0h; IRO=3,4,5,6,7,9,10,11,12 IO=2E0h; IRO=3,4,5,6,7,9,10,11,12	Select an optimal settings for Super IO Device

4.6.2.7 EC 5792 H/W monitor

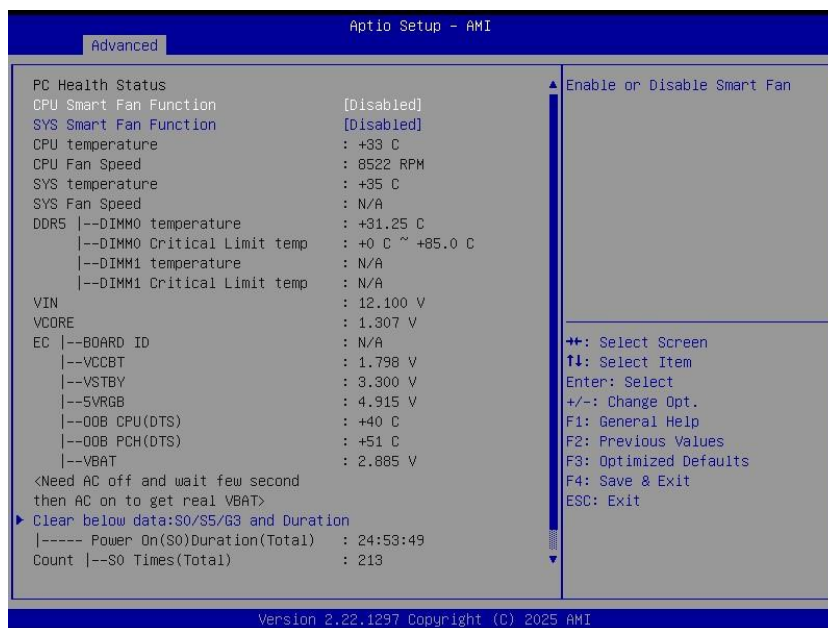

Item	Options	Description
CPU Smart Fan Function	Disabled[Default] Enabled,	Enable or Disable Smart Fan.
SYS Smart Fan Function	Disabled[Default] Enabled,	Smart Fan Mode select

EMX-W880P User's Manual

4.6.2.7.1 Clear below data:S0/S5/G3 and Duration

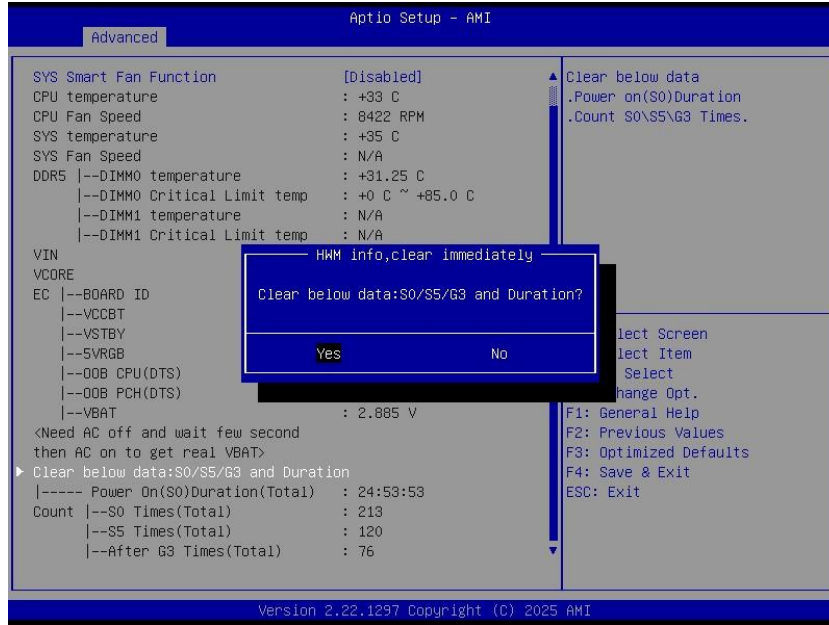

Item	Options	Description
Clear below data:S0/S5/G3 and Duration	Yes[Default] No,	Clear below data .Power on(S0)Duration .Count S0\S5\G3 Times.

4.6.2.8 S5 RTC Wake Settings

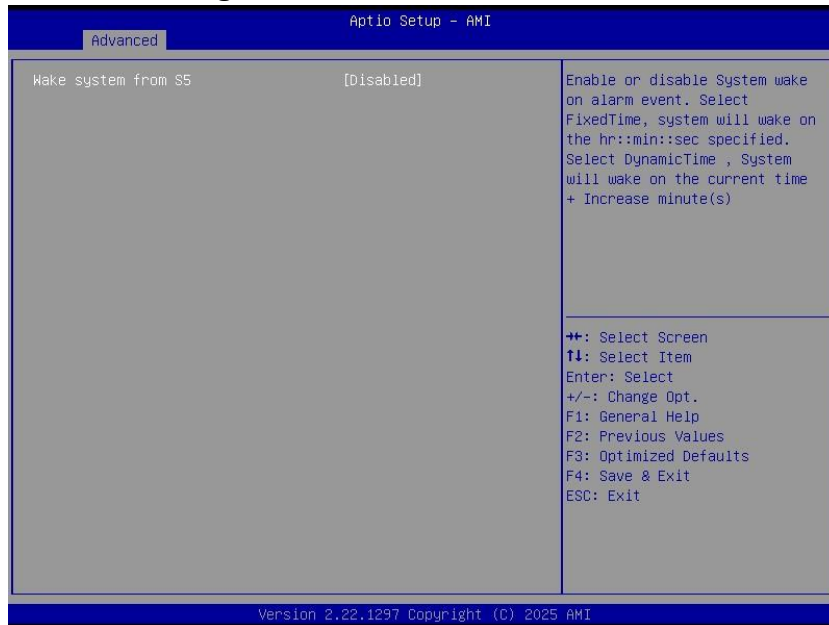

Item	Options	Description
Wake system from S5	Disabled[Default], Fixed Time Dynamic Time	Enable or disable System wake on alarm event. Select Fixed Time, system will wake on the hr::min::sec specified. Select Dynamic Time, System will wake on the current time + Increase minute(s).

4.6.2.9 Serial Port Console Redirection

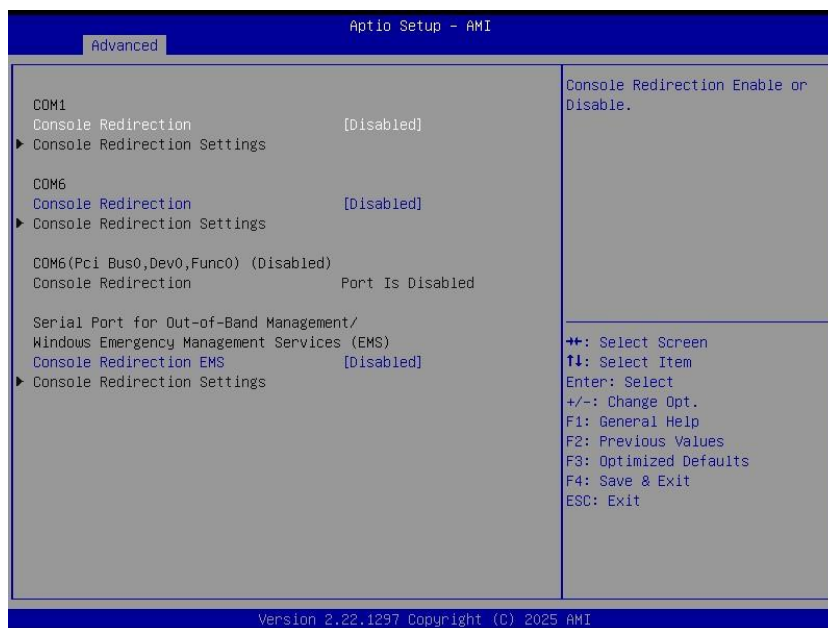

Item	Options	Description
Console Redirection	Disabled[Default], Enabled	Console Redirection Enable or Disable.
Console Redirection EMS	Disabled[Default], Enabled	Console Redirection Enable or Disable.

4.6.2.10 USB Configuration

The USB Configuration menu helps read USB information and configures USB settings.

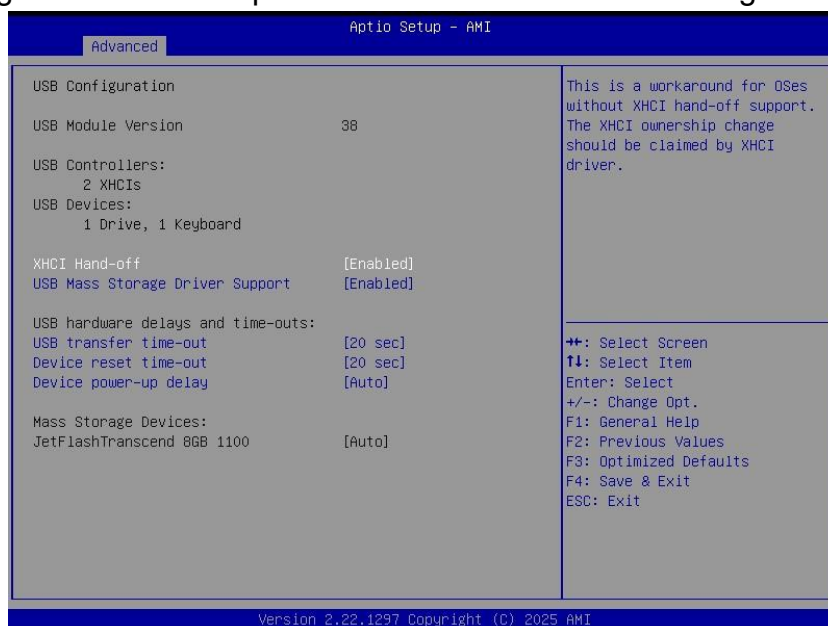

EMX-W880P User's Manual

Item	Options	Description
XHCI Hand-off	Enabled[Default] Disabled	This is a workaround for OSes without XHCI hand-off support. The XHCI ownership change should be claimed by XHCI driver.
USB Mass Storage Driver Support	Disabled Enabled[Default]	Enable/Disable USB Mass Storage Driver Support.
USB transfer time-out	1 sec 5 sec 10 sec 20 sec[Default]	The time-out value for Control, Bulk, and Interrupt transfers.
Device reset time-out	10 sec 20 sec[Default] 30 sec 40 sec	USB mass storage device Start Unit command time-out.
Device power-up delay	Auto[Default] Manual	Maximum time the device will take before it properly reports itself to the Host Controller. 'Auto' uses default value: for a Root port it is 100 ms, for a Hub port the delay is taken from Hub descriptor.

4.6.2.11 Network Stack Configuration

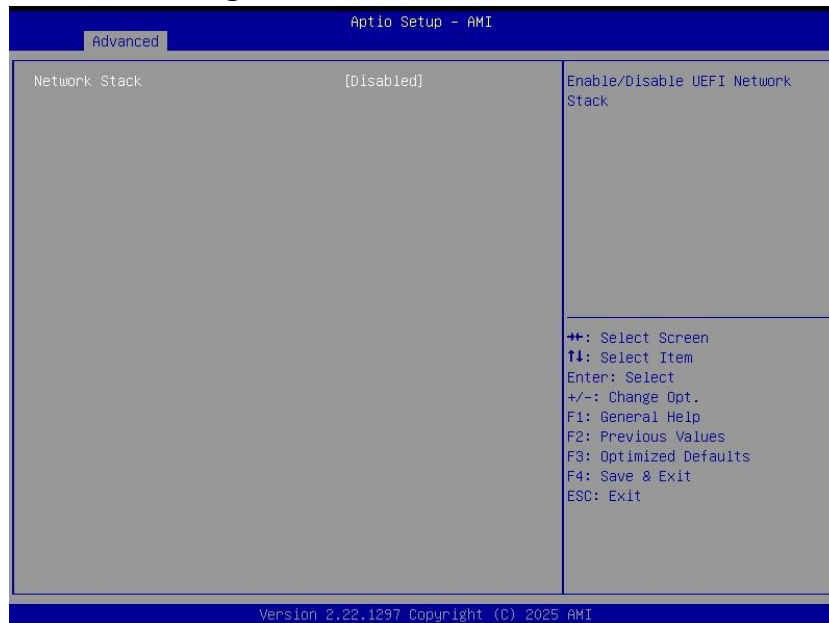

Item	Options	Description
Network Stack	Disabled[Default] Enabled	Enable/Disable UEFI Network Stack.

4.6.2.12 NVMe Configuration

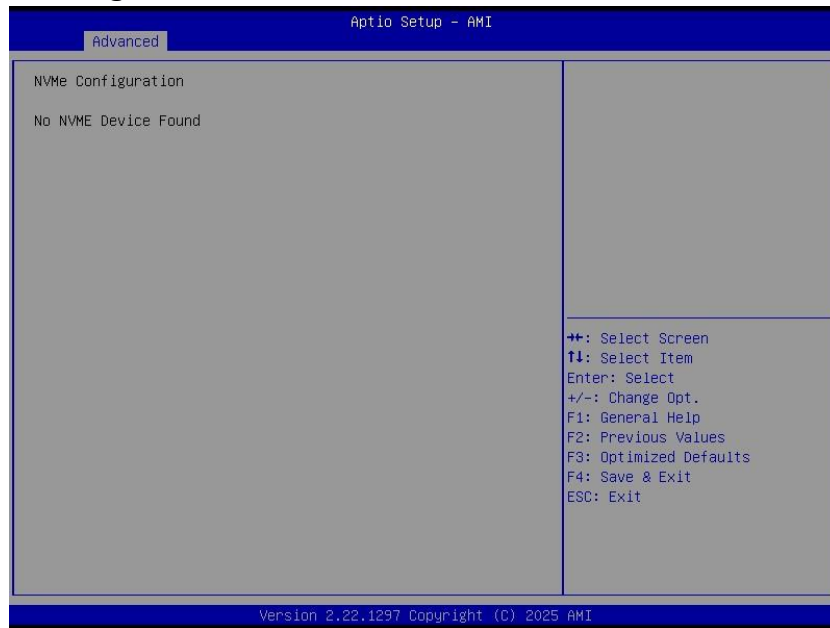

4.6.2.13 Intel(R) Rapid Storage Technology



4.6.3 Chipset

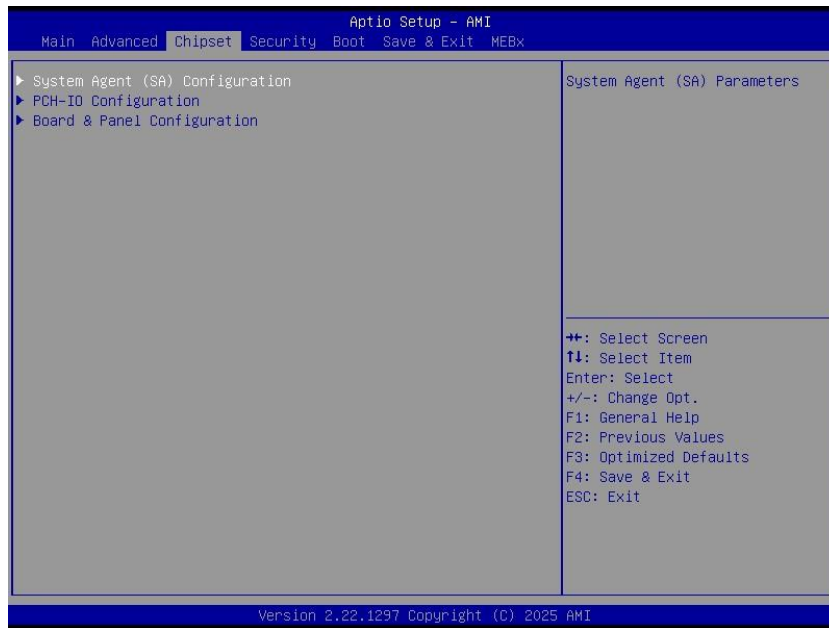

4.6.3.1 System Agent (SA) Configuration

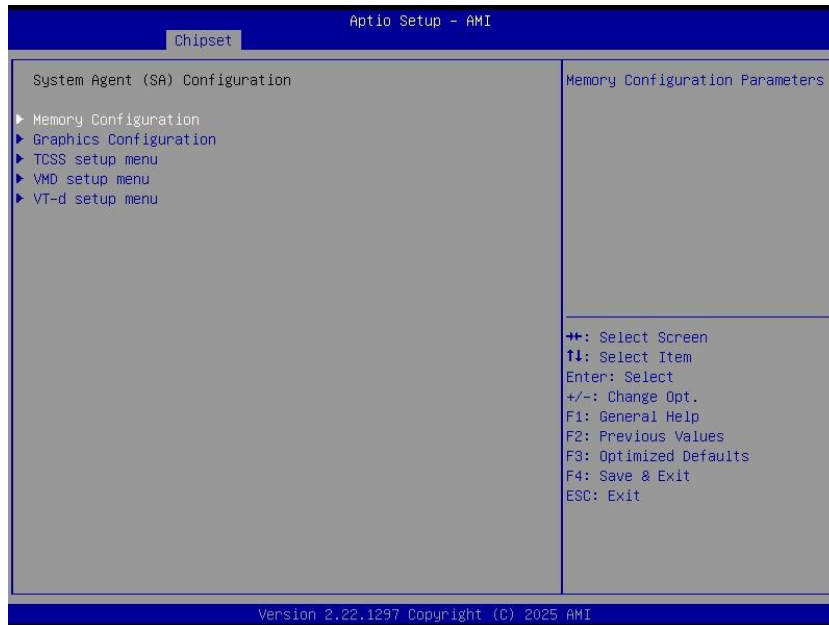

4.6.3.1.1 Memory Configuration

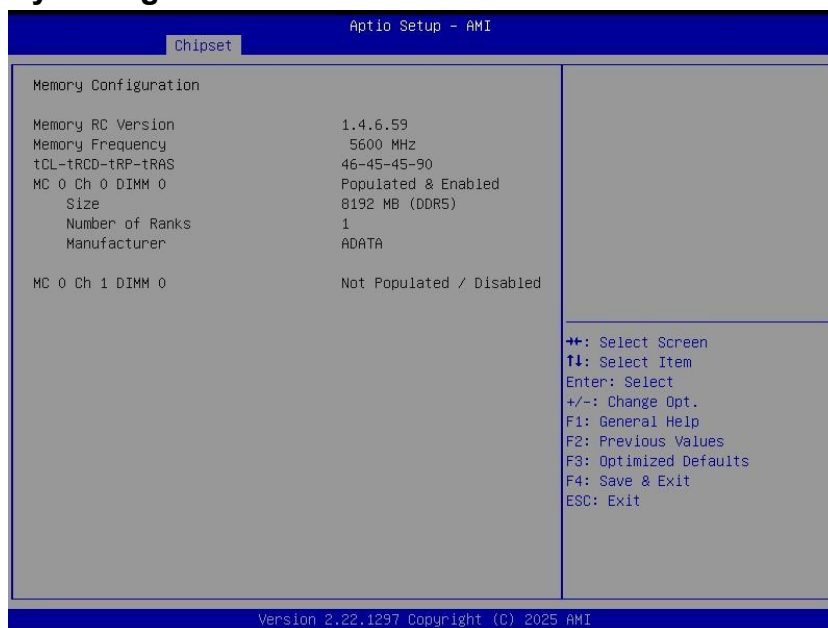

4.6.3.1.2 Graphics Configuration



Item	Option	Description
Primary Display	Auto[Default] IGFX HG	Select AUTO set IGD to be Primary Display if no external Graphics Device connected otherwise external Graphics Device detected on first PCIe port will be Primary Display or Select IGFX for IGD to be Primary Display Or Select HG for Hybrid Gfx.
Internal Graphics	Auto[Default] Disabled Enabled	Keep IGFX enabled based on the setup options.

4.6.3.1.3 TCSS setup menu

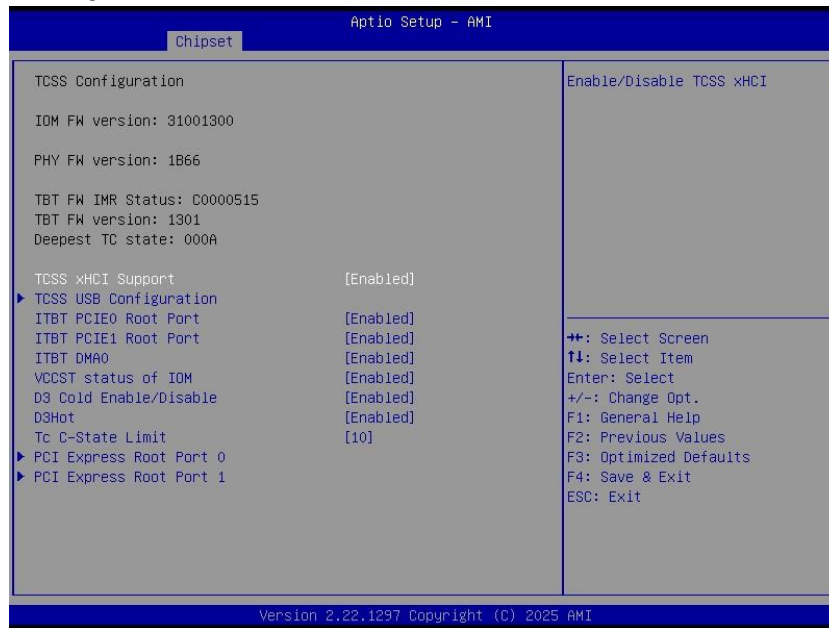

Item	Option	Description
TCSS xHCI Support	Disabled Enabled[Default]	Enable/Disable TCSS xHCI
ITBT PCIE0/1 Root Port	Disabled Enabled[Default]	Enable/Disable ITBT PCIE0 Root
ITBT PCIE1 Root Port	Disabled Enabled[Default]	Enable/Disable ITBT PCIE1 Root
ITBT DMA0	Disabled Enabled[Default]	Enable/Disable ITBT DMA0
VCCST status of IOM	Disabled Enabled[Default]	Enables/Disables VCCST. Enable: Sends VCCST ON message to EC or PMC Disable: Sends VCCST OFF message to EC or PMC
D3 Cold Enable/Disable	Disabled Enabled[Default]	Enables/Disables D3 Cold. Enable: D3 cold support for IOM is enabled Disable: D3 cold support for IOM is Disabled
D3Hot	Disabled Enabled[Default]	Enables/Disables D3 Hot. Enable: D3 Hot support for IOM is enabled Disable: D3 Hot support for IOM is Disabled
Tc C-State Limit	Disable/1/2/4/5/6/7/ 10[Default]	BIOS mailbox to limit deepest TCx state

4.6.3.1.3.1 TCSS USB Configuration



Item	Option	Description
USB CONNECT OVERRIDE	Disabled[Default] Enabled	Option will allow VCCSTTPC to turn off even when there is a connection for a USB3 port.
TCSS xDCI Support	Disabled[Default] Enabled	Enable/Disable TCSS xDCI
TCSS CPU USB PDO Programming	Disabled Enabled[Default]	Select 'Enabled' if Port Disable Override functionality is used.
TCSS CPU USB Port Disable Override	Disabled[Default] Select Per-Pin	Selectively Enable/Disable the corresponding USB port from reporting a Device Connection to the controller.

4.6.3.1.3.2 PCI Express Root Port 0

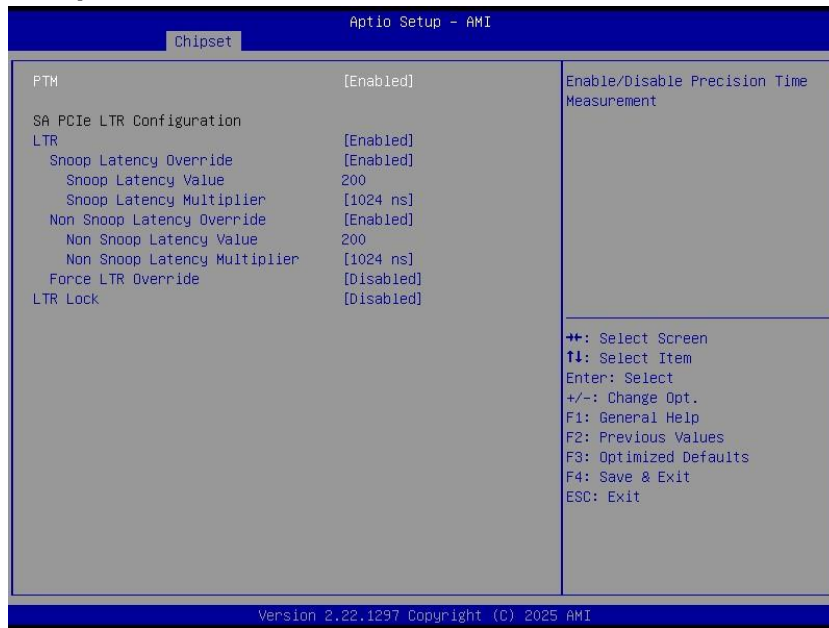

Item	Option	Description
PTM	Enabled[Default] Disabled	Enable/Disable Precision Time Measurement
LTR	Disabled Enabled[Default]	PCIE Latency Reporting Enable/Disable
Snoop Latency Override	Disabled Enabled[Default]	Snoop Latency Override for SA PCIE. Disabled: Disable override. Manual: Manually enter override values. Auto (default): Maintain default BIOS flow.
Snoop Latency Value	200	LTR Snoop Latency value of SA PCIE
Snoop Latency Multiplier	1 ns 32 ns 1024 ns[Default] 32768 ns 1048576 ns 33554432 ns	LTR Snoop Latency Multiplier of SA PCIE
Non Snoop Latency Override	Disabled Enabled[Default]	Non Snoop Latency Override for SA PCIE. Disabled: Disable override. Manual: Manually enter override values. Auto (default): Maintain default BIOS flow.
Non Snoop Latency Value	200	LTR Non Snoop Latency value of SA PCIE
Non Snoop Latency Multiplier	1 ns 32 ns 1024 ns[Default] 32768 ns 1048576 ns 33554432 ns	LTR Non Snoop Latency Multiplier of SA PCIE

Force LTR Override	Disabled [Default] Enabled	Force LTR Override for ITBT PCIE. Disabled: LTR override values will not be forced. Enable: LTR override values will be forced and LTR messages from the device will be ignored.
LTR Lock	Disabled [Default] Enabled	PCIE LTR Configuration Lock

4.6.3.1.3.3 PCI Express Root Port 1

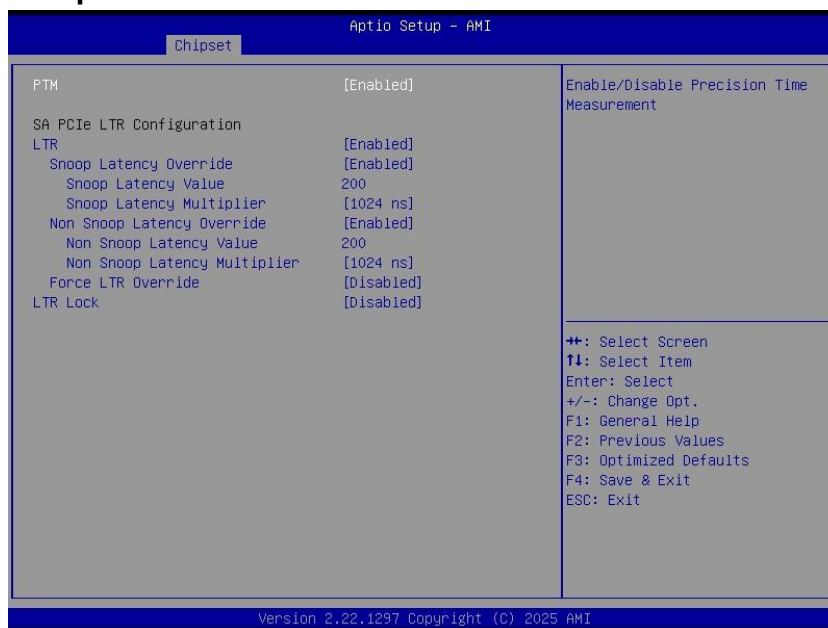

Item	Option	Description
PTM	Enabled [Default] Disabled	Enable/Disable Precision Time Measurement
LTR	Disabled Enabled [Default]	PCIE Latency Reporting Enable/Disable
Snoop Latency Override	Disabled Enabled [Default]	Snoop Latency Override for SA PCIE. Disabled: Disable override. Manual: Manually enter override values. Auto (default): Maintain default BIOS flow.
Snoop Latency Value	200	LTR Snoop Latency value of SA PCIE
Snoop Latency Multiplier	1 ns 32 ns 1024 ns [Default] 32768 ns 1048576 ns 33554432 ns	LTR Snoop Latency Multiplier of SA PCIE
Non Snoop Latency Override	Disabled Enabled [Default]	Non Snoop Latency Override for SA PCIE. Disabled: Disable override. Manual: Manually enter override values. Auto (default): Maintain default BIOS flow.
Non Snoop Latency Value	200	LTR Non Snoop Latency value of SA PCIE

EMX-W880P User's Manual

Non Snoop Latency Multiplier	1 ns 32 ns 1024 ns[Default] 32768 ns 1048576 ns 33554432 ns	LTR Non Snoop Latency Multiplier of SA PCIE
Force LTR Override	Disabled[Default] Enabled	Force LTR Override for ITBT PCIE. Disabled: LTR override values will not be forced. Enable: LTR override values will be forced and LTR messages from the device will be ignored.
LTR Lock	Disabled[Default] Enabled	PCIE LTR Configuration Lock

4.6.3.1.4 VMD setup menu



Item	Option	Description
Enable VMD controller	Disabled Enabled[Default]	Enable/Disable to VMD controller
Enable VMD Global Mapping	Disabled[Default] Enabled	Enable/Disable to Global Mapping
Map PCH SATA Controller Under VMD	Disabled[Default] Enabled	Places SATA under the VMD to be part of a VMD-managed RAID array. SATA can only do raid with SATA
RAID0	Disabled Enabled[Default]	Enable/Disable RAID0 support
RAID1	Disabled Enabled[Default]	Enable/Disable RAID1 support

4.6.3.1.5 VT-d setup menu

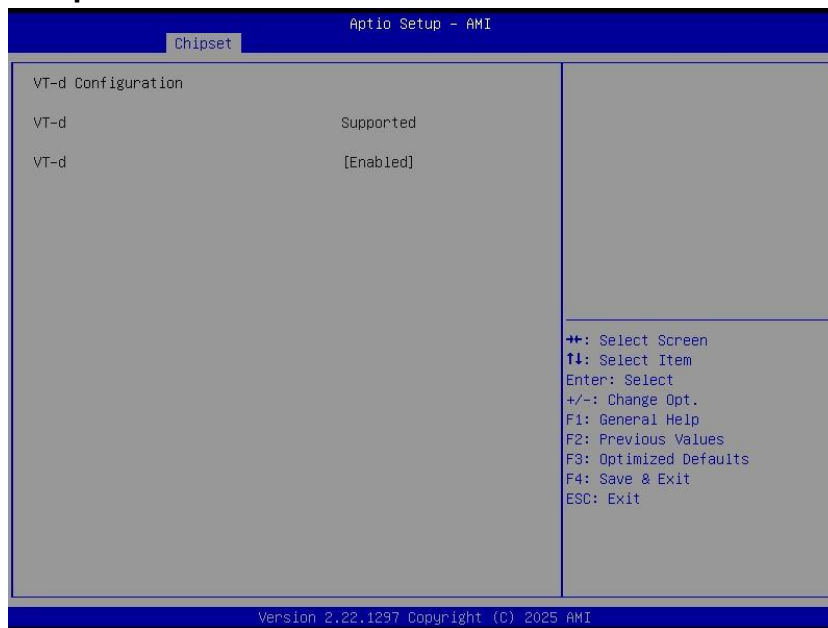

4.6.3.2 PCH-IO Configuration



EMX-W880P User's Manual

4.6.3.2.1 PCI Configuration

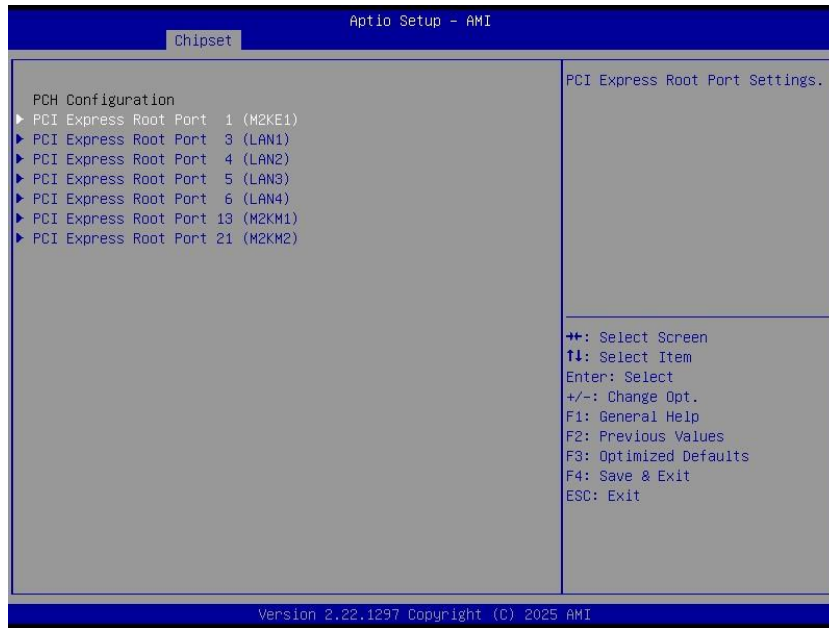

4.6.3.2.1.1 PCI Express Root Port 1 (M2KE1)

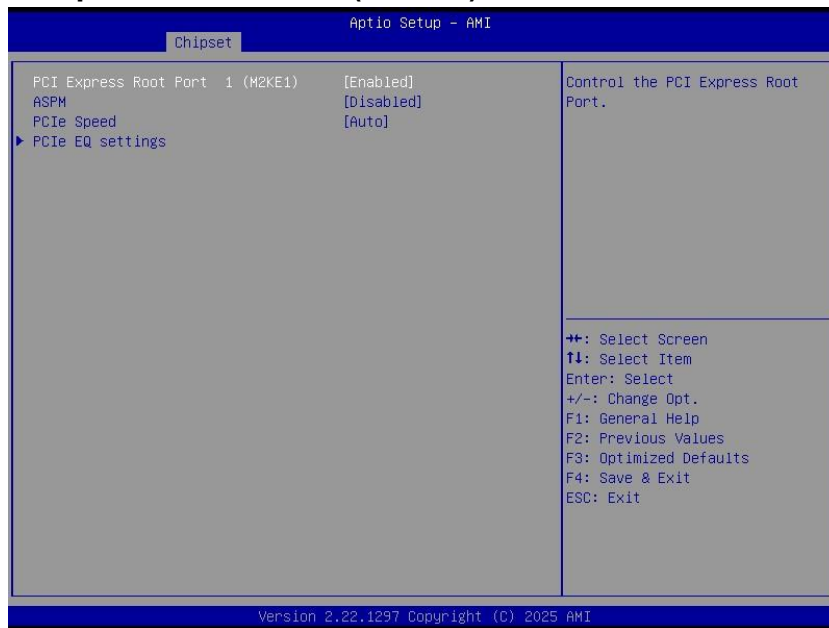

Item	Option	Description
PCI Express Root Port 1 (M2KE1)	Disabled Enabled[Default]	Control the PCI Express Root Port
ASPM	Disabled[Default] L1 Auto	Set the ASPM Level: Force L0s – Force all links to L0s State AUTO – BIOS auto configure DISABLE – Disables ASPM
PCIe Speed	Auto[Default] Gen 1 Gen 2 Gen 3	Configure PCIe Speed.

4.6.3.2.1.1.1 PCIe EQ settings



Item	Option	Description
PCIe EQ settings	Disabled Enabled[Default]	

4.6.3.2.1.2 PCI Express Root Port 3 (LAN1)

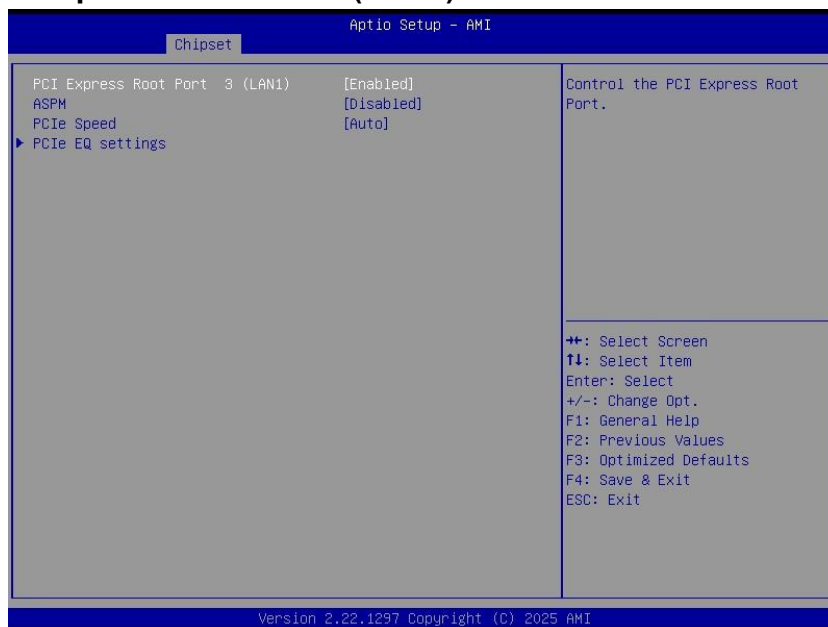

Item	Option	Description
PCI Express Root Port 3 (LAN1)	Disabled Enabled[Default]	Control the PCI Express Root Port

EMX-W880P User's Manual

ASPM	Disabled[Default] L1 Auto	Set the ASPM Level: Force L0s – Force all links to L0s State AUTO – BIOS auto configure DISABLE – Disables ASPM
PCIe Speed	Auto[Default] Gen 1 Gen 2 Gen 3	Configure PCIe Speed.

4.6.3.2.1.2.1 PCIe EQ settings



Item	Option	Description
PCIe EQ override	Disabled Enabled[Default]	Choose your own PCIe EQ settings, only for users who have a thorough understanding of equalization process

4.6.3.2.1.3 PCI Express Root Port 4 (LAN2)

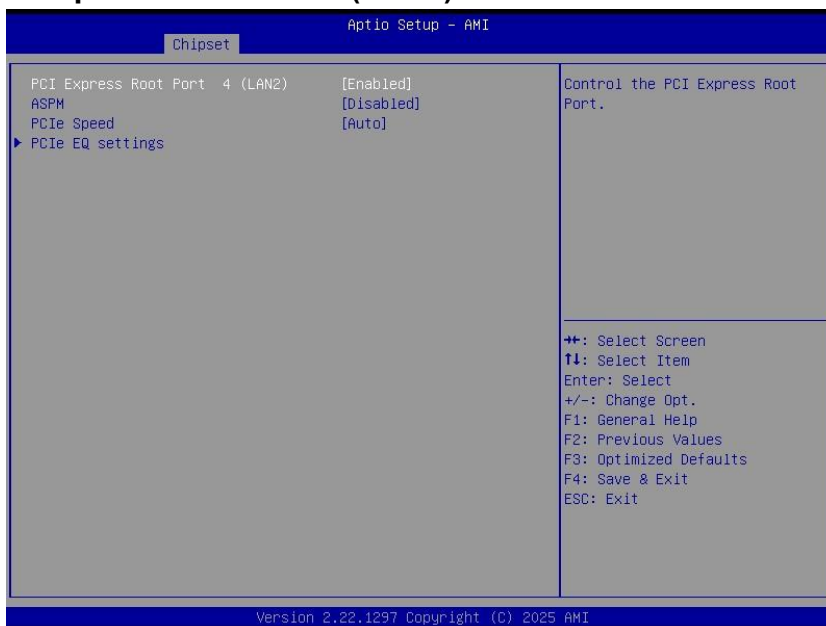

Item	Option	Description
PCI Express Root Port 4 (LAN2)	Disabled Enabled [Default]	Control the PCI Express Root Port
ASPM	Disabled [Default] L1 Auto	Set the ASPM Level: Force L0s – Force all links to L0s State AUTO – BIOS auto configure DISABLE – Disables ASPM
PCIe Speed	Auto [Default] Gen 1 Gen 2 Gen 3	Configure PCIe Speed.

4.6.3.2.1.3.1 PCIe EQ settings



EMX-W880P User's Manual

Item	Option	Description
PCIe EQ override	Disabled Enabled[Default]	Choose your own PCIe EQ settings, only for users who have a thorough understanding of equalization process

4.6.3.2.1.4 PCI Express Root Port 5 (LAN3)

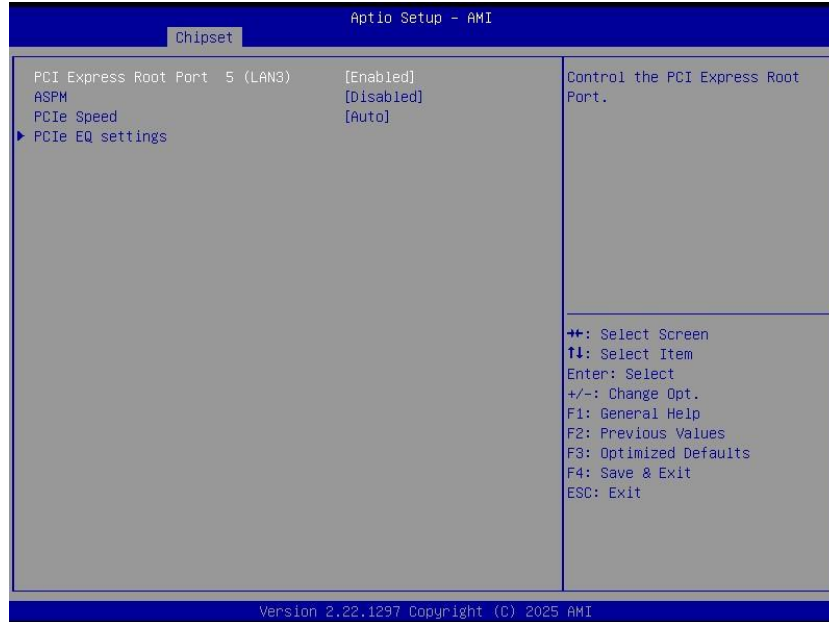

Item	Option	Description
PCI Express Root Port 5 (LAN3)	Disabled Enabled[Default]	Control the PCI Express Root Port
ASPM	Disabled[Default] L1 Auto	Set the ASPM Level: Force L0s – Force all links to L0s State AUTO – BIOS auto configure DISABLE – Disables ASPM
PCIe Speed	Auto[Default] Gen 1 Gen 2 Gen 3	Configure PCIe Speed.

4.6.3.2.1.4.1 PCIe EQ settings



Item	Option	Description
PCIe EQ override	Disabled Enabled[Default]	Choose your own PCIe EQ settings, only for users who have a thorough understanding of equalization process

4.6.3.2.1.5 PCI Express Root Port 6 (LAN4)



Item	Option	Description
PCI Express Root Port 6 (LAN4)	Disabled Enabled[Default]	Control the PCI Express Root Port
ASPM	Disabled[Default] L1 Auto	Set the ASPM Level: Force L0s – Force all links to L0s State AUTO – BIOS auto configure DISABLE – Disables ASPM

EMX-W880P User's Manual

PCIe Speed	Auto[Default] Gen 1 Gen 2 Gen 3	Configure PCIe Speed.
-------------------	---	-----------------------

4.6.3.2.1.5.1 PCIe EQ settings

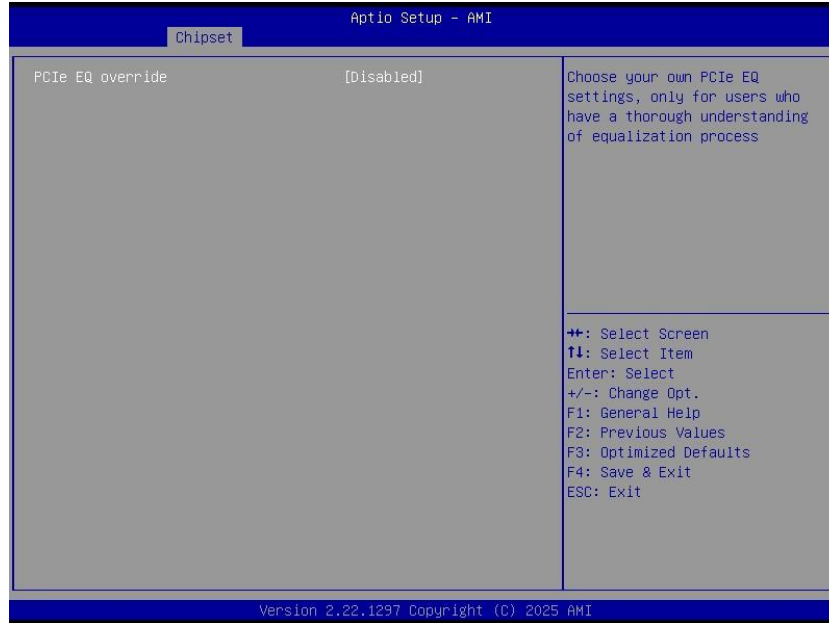

Item	Option	Description
PCIe EQ override	Disabled Enabled[Default]	Choose your own PCIe EQ settings, only for users who have a thorough understanding of equalization process

4.6.3.2.1.6 PCI Express Root Port 13 (M2KM1)

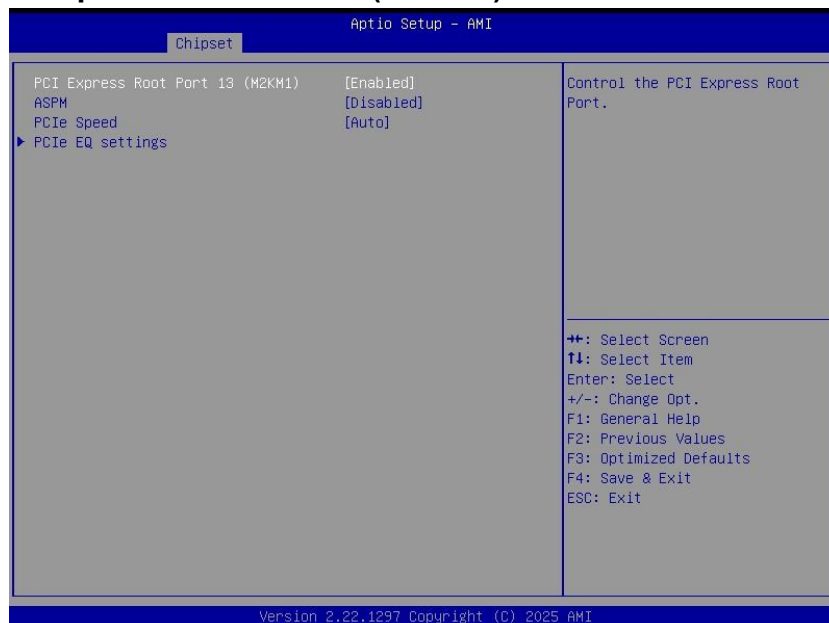

Item	Option	Description
PCI Express Root Port 13 (M2KM1)	Disabled Enabled[Default]	Control the PCI Express Root Port
ASPM	Disabled[Default] L1 Auto	Set the ASPM Level: Force L0s – Force all links to L0s State AUTO – BIOS auto configure DISABLE – Disables ASPM
PCIe Speed	Auto[Default] Gen 1 Gen 2 Gen 3	Configure PCIe Speed.

4.6.3.2.1.6.1 PCIe EQ settings



Item	Option	Description
PCIe EQ override	Disabled Enabled[Default]	Choose your own PCIe EQ settings, only for users who have a thorough understanding of equalization process

EMX-W880P User's Manual

4.6.3.2.1.7 PCI Express Root Port 21 (M2KM2)

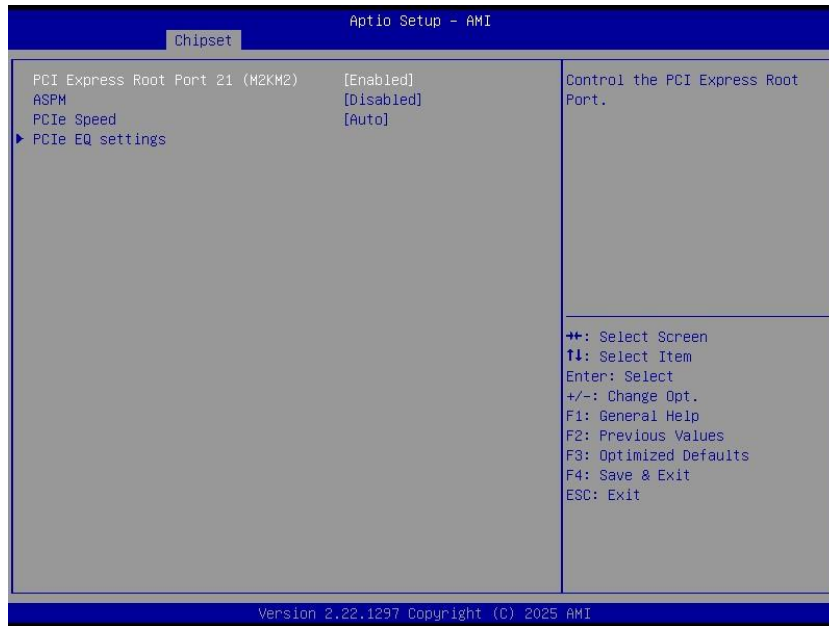

Item	Option	Description
PCI Express Root Port 21 (M2KM2)	Disabled Enabled [Default]	Control the PCI Express Root Port
ASPM	Disabled [Default] L1 Auto	Set the ASPM Level: Force L0s – Force all links to L0s State AUTO – BIOS auto configure DISABLE – Disables ASPM
PCIe Speed	Auto [Default] Gen 1 Gen 2 Gen 3	Configure PCIe Speed.

4.6.3.2.1.7.1 PCIe EQ settings



Item	Option	Description
PCIe EQ override	Disabled Enabled[Default]	Choose your own PCIe EQ settings, only for users who have a thorough understanding of equalization process

4.6.3.2.2 SATA Configuration

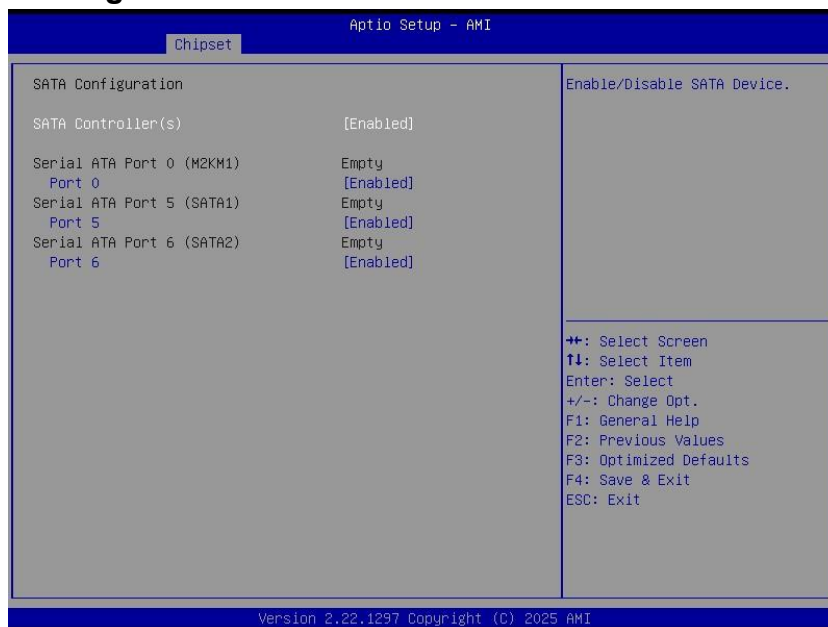

Item	Option	Description
SATA Controller(s)	Enabled[Default] Disabled	Enable/Disable SATA Device.
Port 5	Disabled Enabled[Default]	Enable or Disable SATA Port
Port 6	Disabled Enabled[Default]	Enable or Disable SATA Port

4.6.3.2.3 HD Audio Configuration

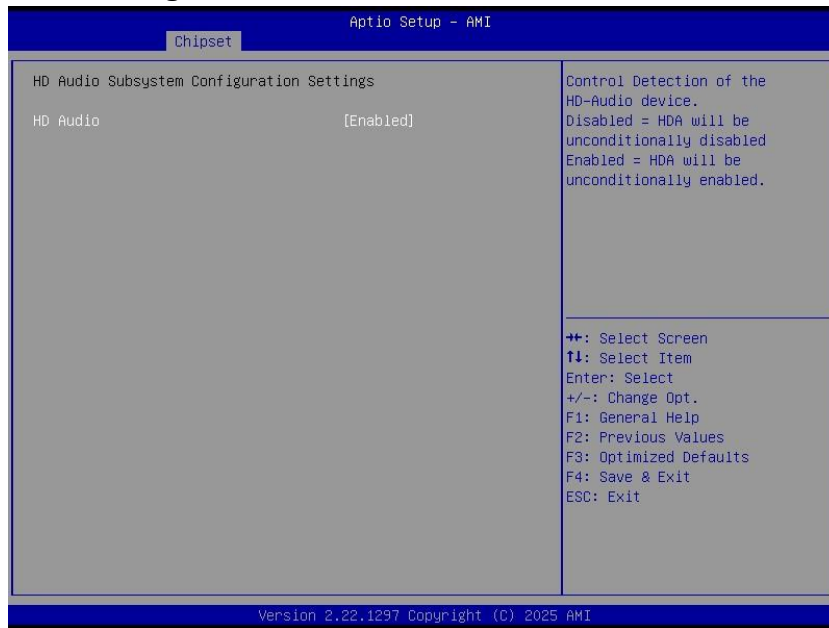

Item	Option	Description
HD Audio	Disabled Enabled[Default],	Control Detection of the HD-Audio device. Disable = HDA will be unconditionally disabled Enabled = HDA will be unconditionally enabled.

4.6.3.3 Board & Panel Configuration

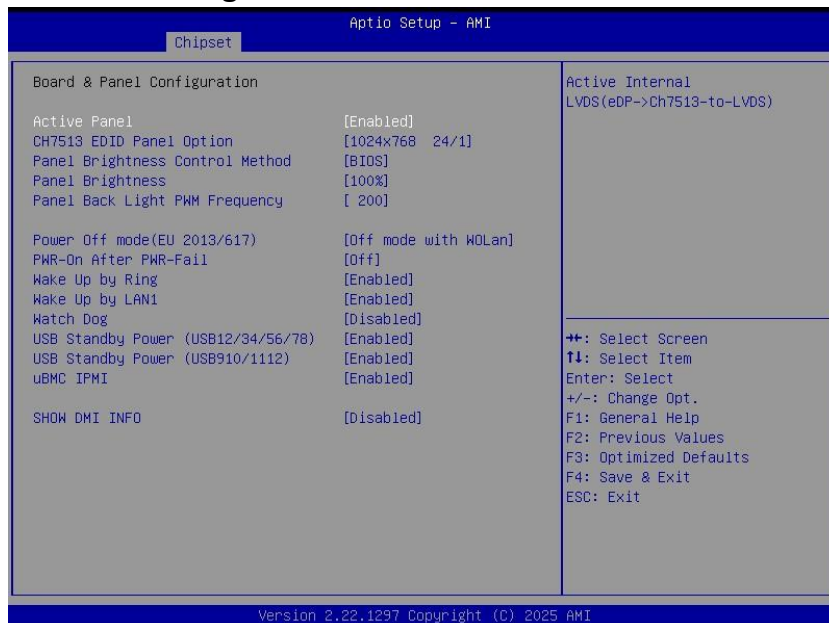

Item	Option	Description
Active Panel	Disabled Enabled[Default]	Active Internal LVDS(eDP->Ch7513-to-LVDS)

CH7513 EDID Panel Option	1024 x 768 24/1[Default] 800 x 600 18/1 1024 x 768 18/1 1366 x 768 18/1 1024 x 600 18/1 1280 x 800 18/1 1920 x 1200 24/2 1920 x 1080 18/2 1280 x 1024 24/2 1440 x 900 18/2 1600 x1200 24/2 1366 x768 24/1 1920 x1080 24/2 7513-eDP	Port1-EDP to LVDS(Chrotel 7513)Panel EDID Option
Panel Brightness Control Method	BIOS[Default] OS Driver	Panel Brightness Control Method. 1.BIOS 2.OS Driver
Panel Brightness	00% 25% 50% 75% 100%[Default]	Select Panel back light PWM duty.
Panel Back Light PWM Frequency	200	Select Panel back light PWM Frequency
Power Off mode (EU 2013/617)	Traditional_S5 Off mode w/o WOL(ErP) Off mode with WOLan[Default]	Off mode with WOLan: Wakeup from Lan1/PWR button Off mode w/o WOL(ErP) Wakeup from PWR button
PWR-On After PWR-Fail	Off[Default], On Last State	AC loss resume.
Wake Up by Ring	Disabled Enabled[Default],	Wake Up by Ring from S3/S4/S5
Wake Up by LAN1	Disabled Enabled[Default],	Wake Up by LAN1 from S3/S4/S5
Watch Dog	Disabled[Default], 30 sec 40 sec 50 sec 1 min 2 min 10 min 30 min	Select WatchDog.
USB Standby Power (USB12/34/56/78)	Disabled Enabled[Default],	Enabled/Disabled USB Standby Power during S3/S4/S5
USB Standby Power (USB910/1112)	Disabled Enabled[Default],	Enabled/Disabled USB Standby Power during S3/S4/S5

EMX-W880P User's Manual

uBMC IPMI	Disabled Enabled[Default],	Enabled/Disabled uBMC IPMI Function.
SHOW DMI INFO	Disabled[Default], Enabled	SHOW DMI INFO

4.6.4 Security



- **Setup Administrator Password**

Set setup Administrator Password

- **User Password**

Set User Password

4.6.4.1 Secure Boot



4.6.4.1.1 Restore Factory Keys

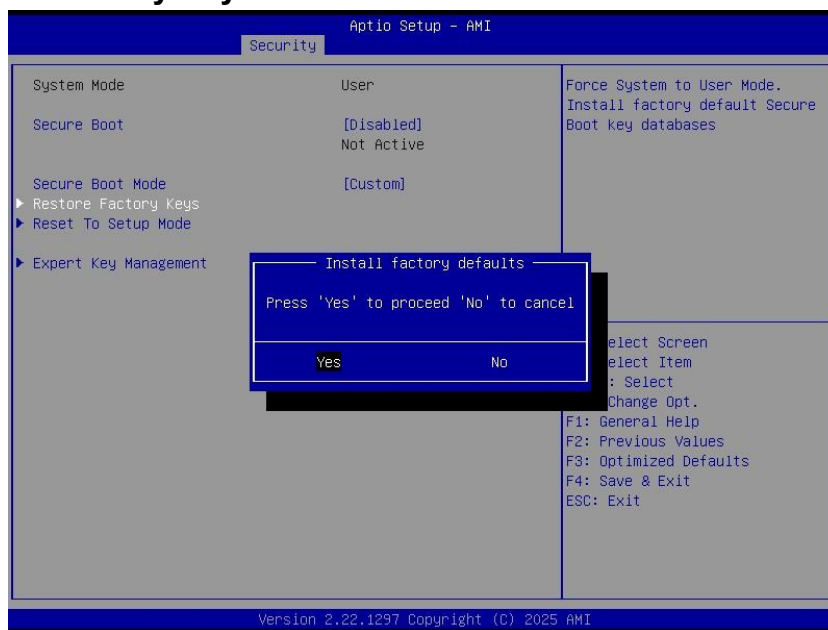

4.6.4.1.2 Reset To Setup Mode



4.6.4.1.3 Expert Key Management

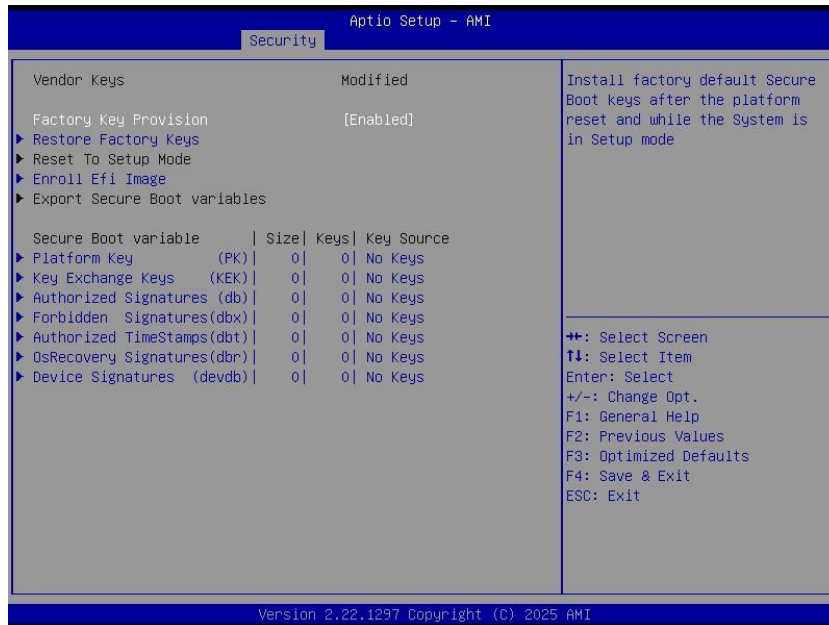

4.6.5 Boot

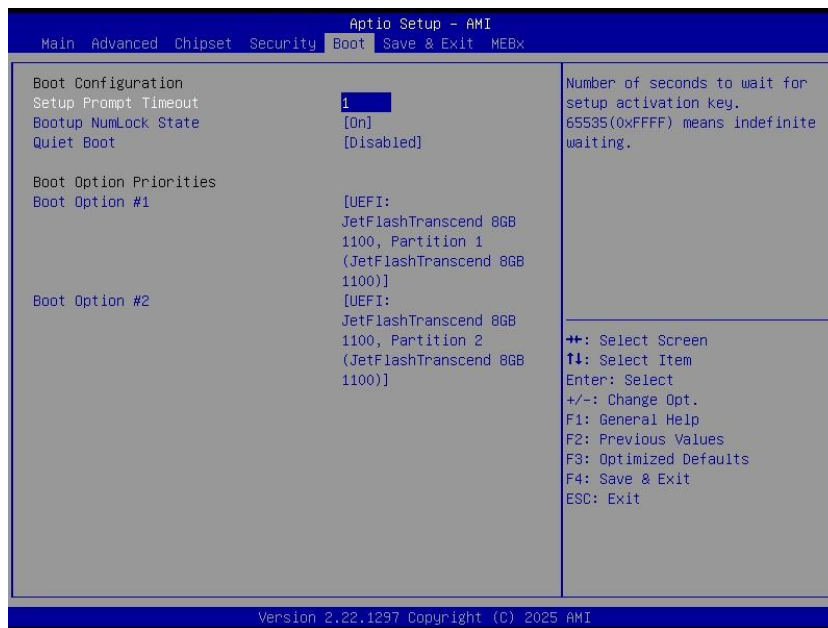

Item	Option	Description
Setup Prompt Timeout	1~ 65535	Number of seconds to wait for setup activation key. 65535(0xFFFF) means indefinite waiting.
Bootup NumLock State	On[Default] Off	Select the Keyboard NumLock state
Quiet Boot	Disabled[Default] Enabled	Enables or disables Quiet Boot option
Boot Option #1	Set the system boot order.	

4.6.6 Save and Exit

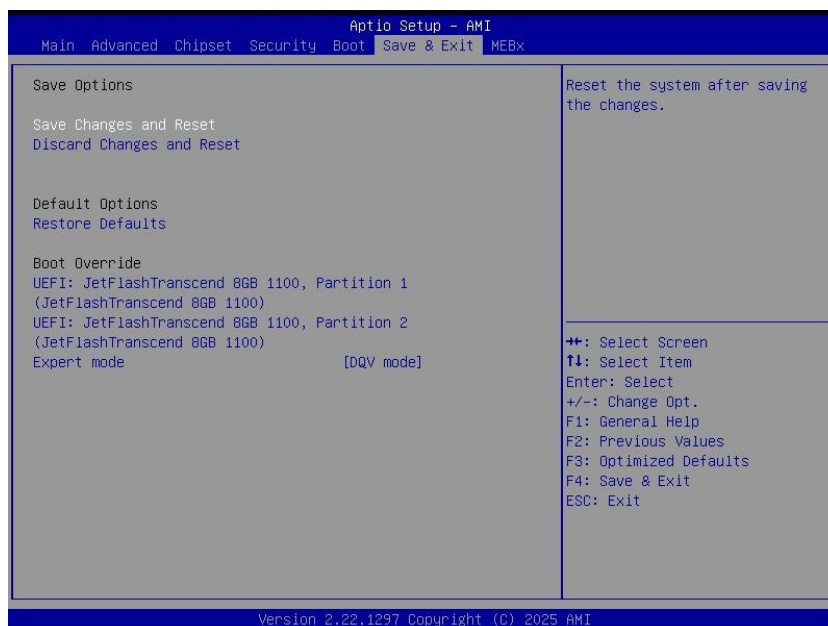

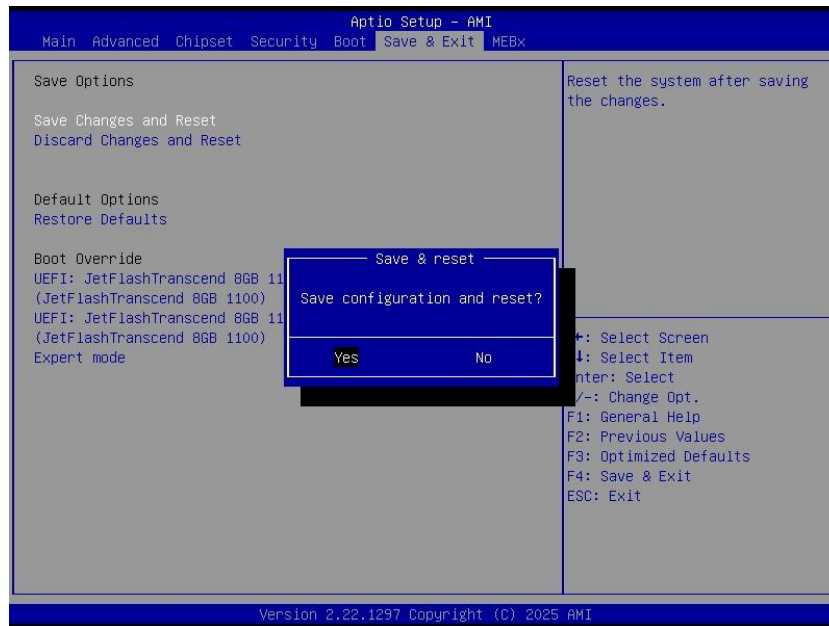

4.6.6.1 **Save Changes and Reset**

Reset the system after saving the changes.

4.6.6.2 **Discard Changes and Reset**

Any changes made to BIOS settings during this session of the BIOS setup program are discarded. The setup program then exits and reboots the controller.

4.6.6.3 **Restore Defaults**

This option restores all BIOS settings to the factory default. This option is useful if the controller exhibits unpredictable behavior due to an incorrect or inappropriate BIOS setting.

4.6.6.4 **Launch EFI Shell from filesystem device**

Attempts to Launch EFI Shell application (Shellx64.efi) from one of the available filesystem devices.

4.6.7 MEBx

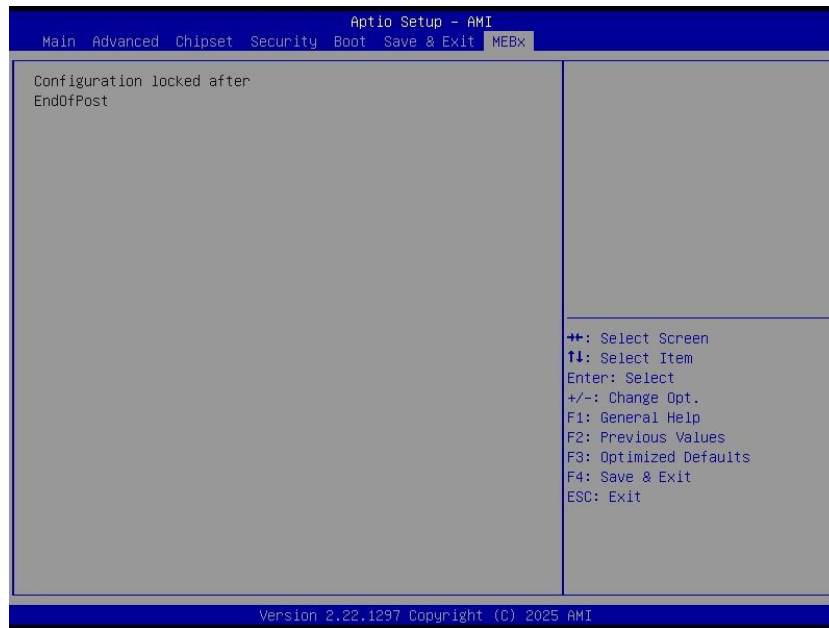

5. Mechanical Drawing



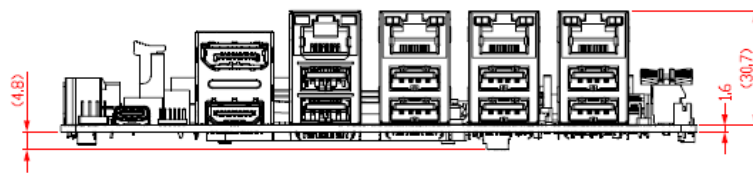
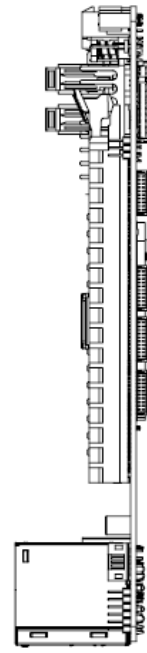
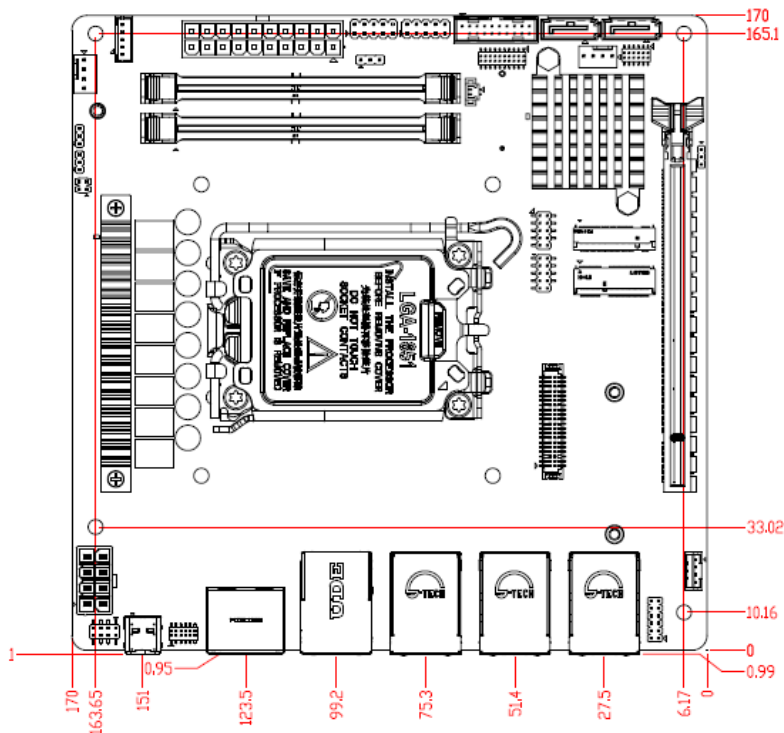

Unit: mm

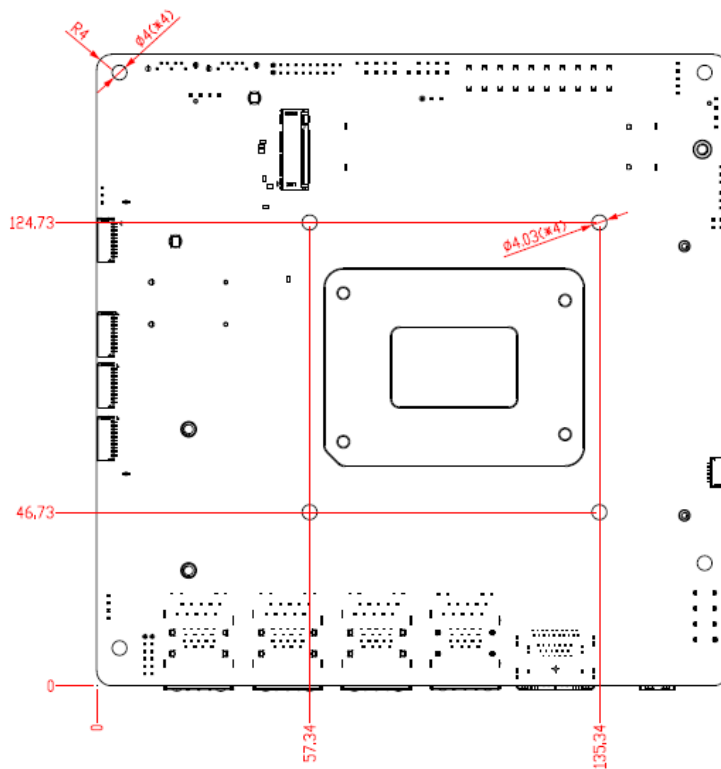

Unit: mm

6. Installation

6.1 Installing E-KEY M.2 2230

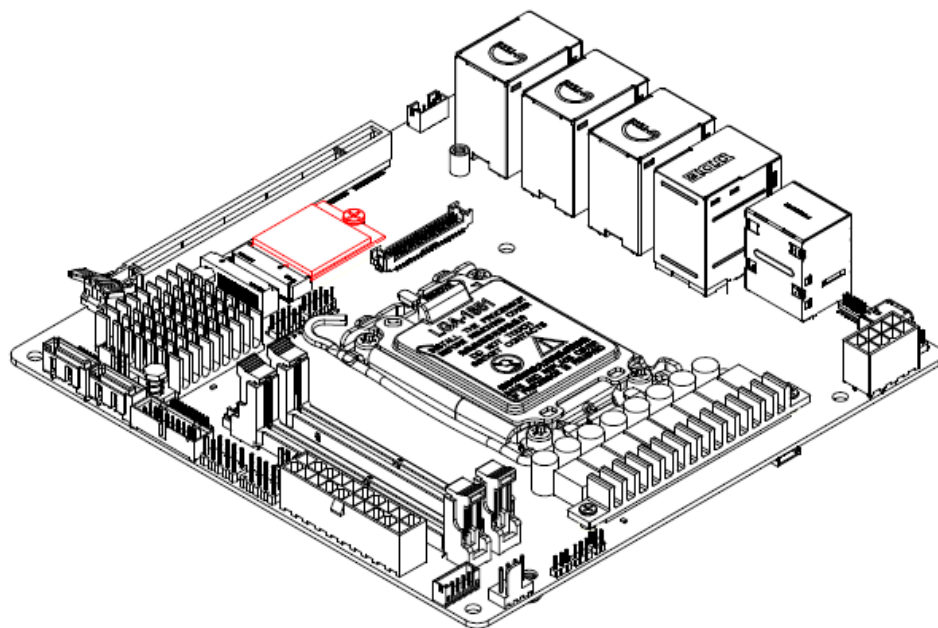
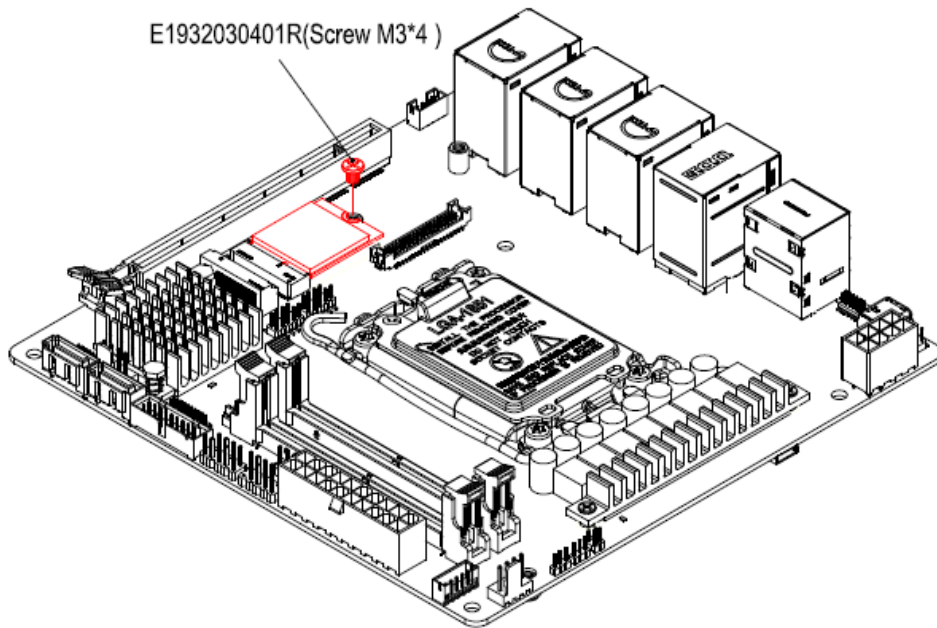

6.2 Installing M-KEY M.2 2242

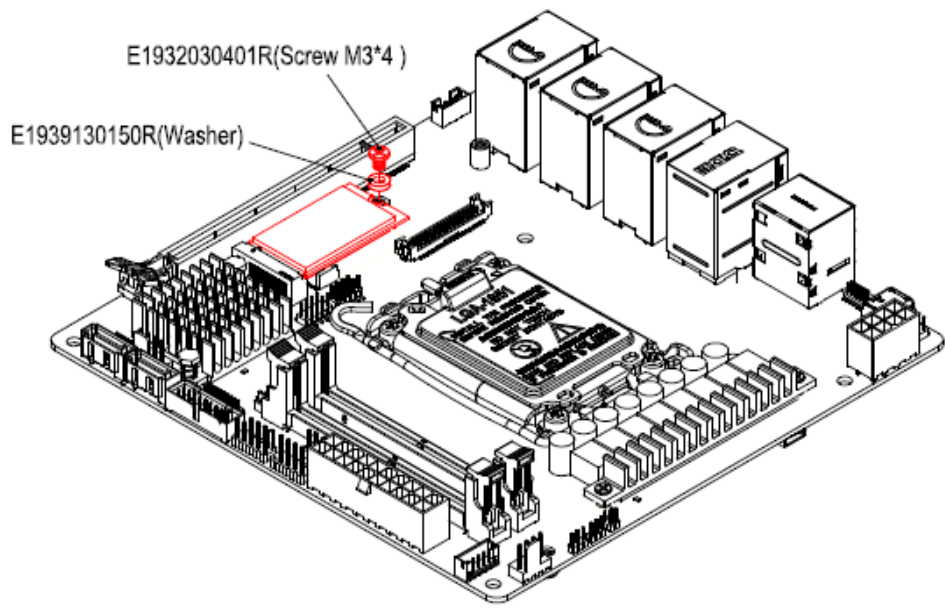
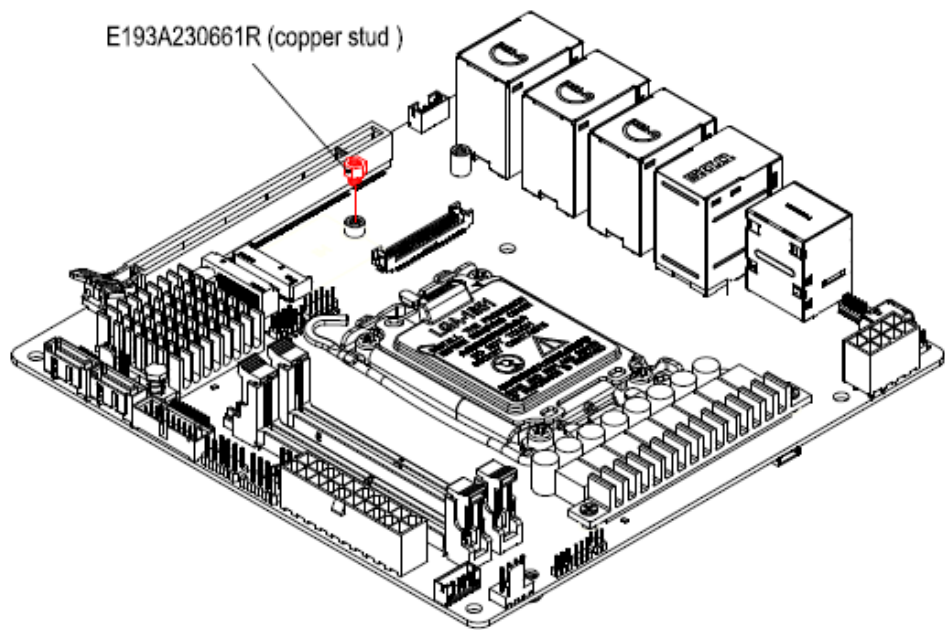

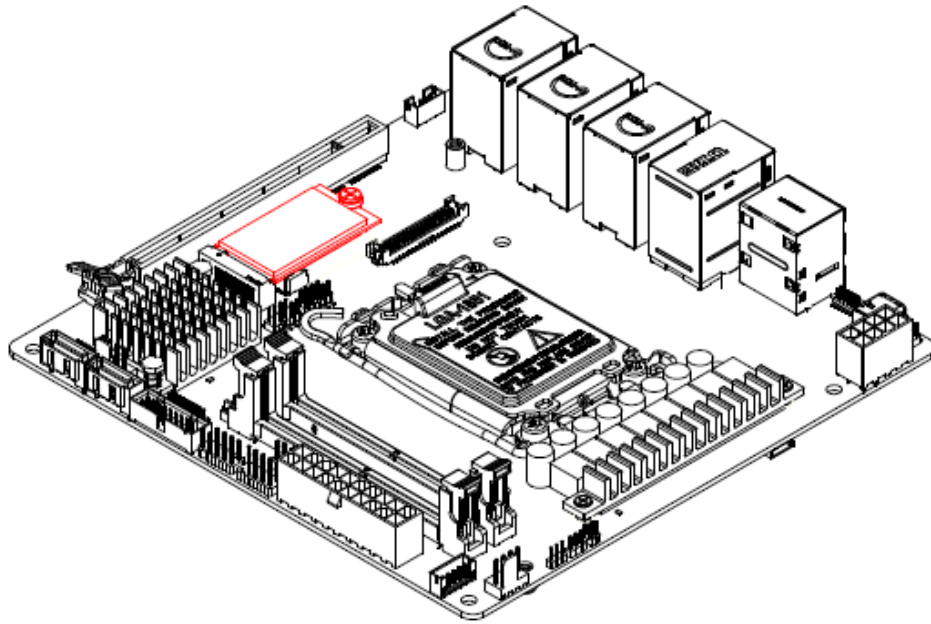

6.3 Installing M-KEY M.2 2280

6.3.1 Top side M-KEY M.2 2280

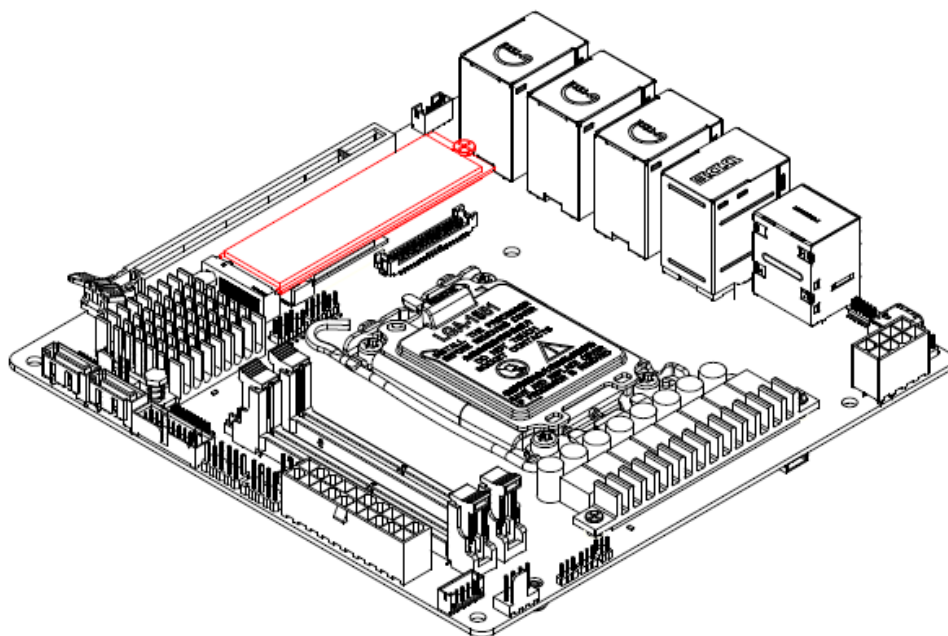
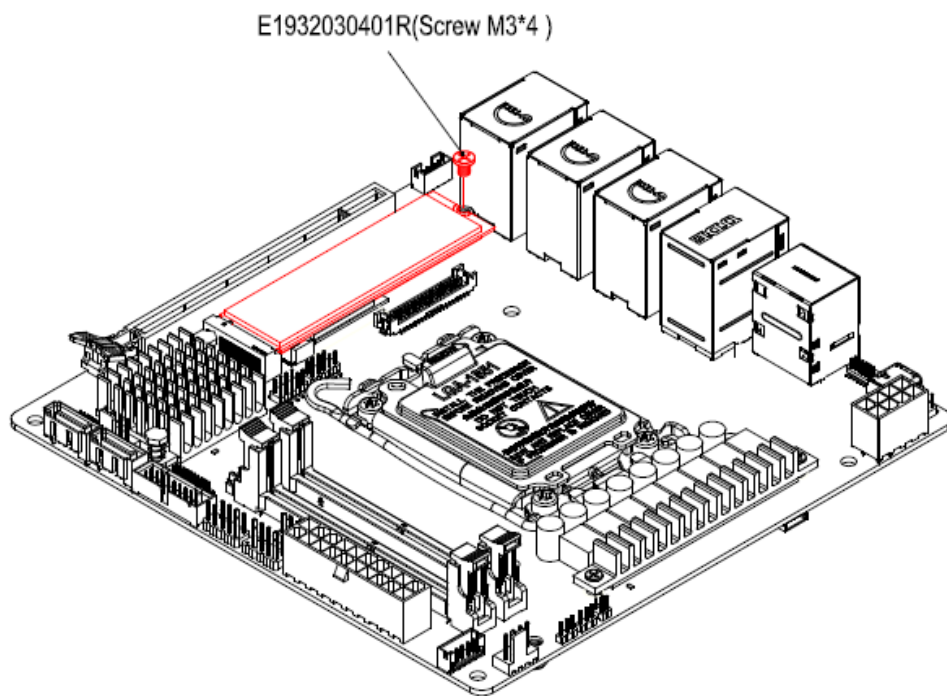

6.3.2 Installing M-KEY M.2 2280

Please note that when using both Key E and Key M at the same time, when modules overlap and the maximum height of the components under Key E needs to be < 0.7mm.

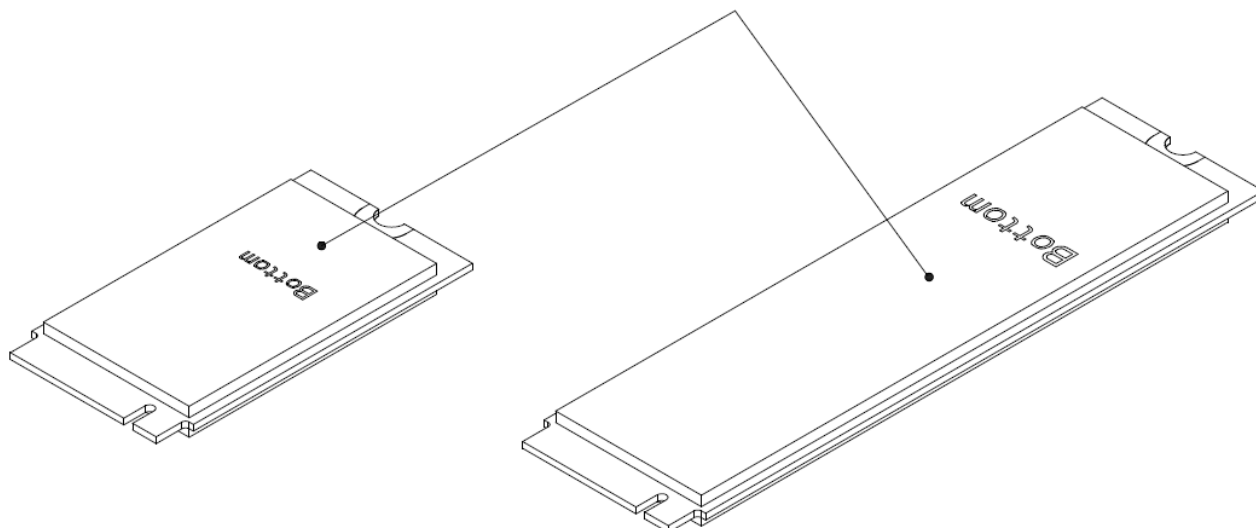

6.3.3 Bottom side M-KEY M.2 2280

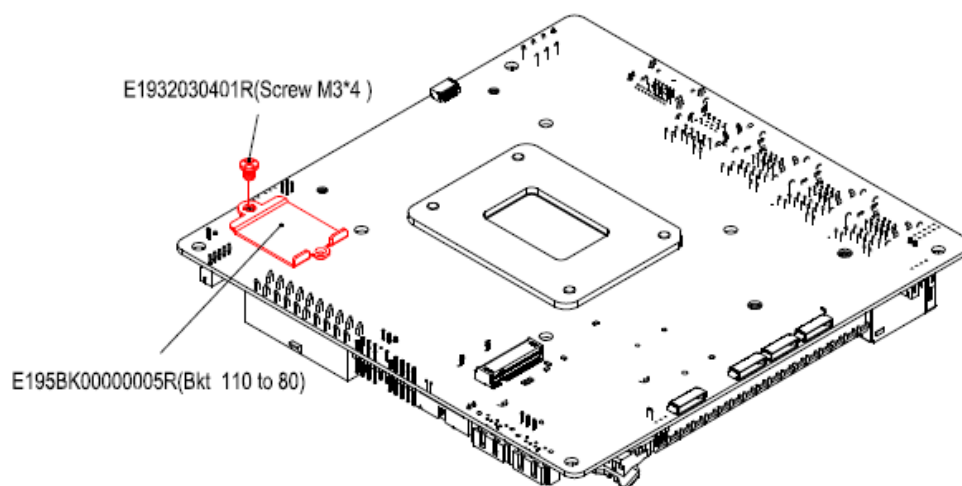

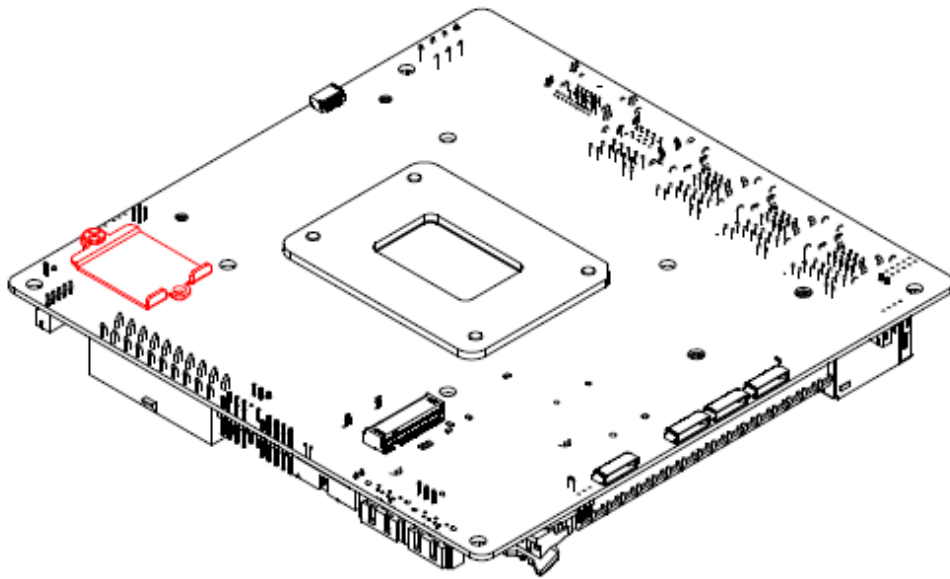

E1932000300R(Screw M2*3 mm)

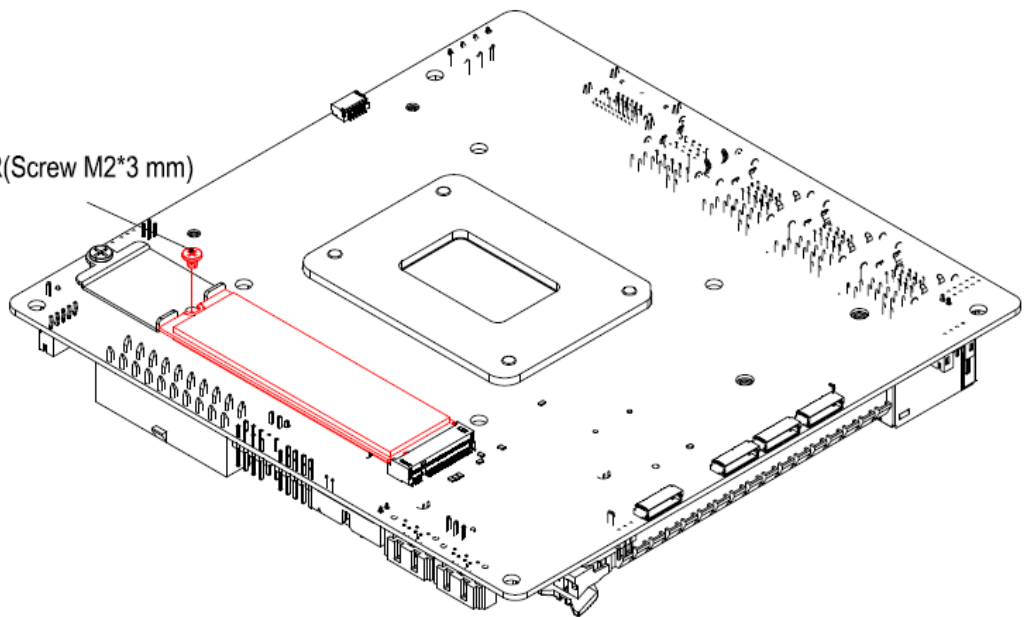

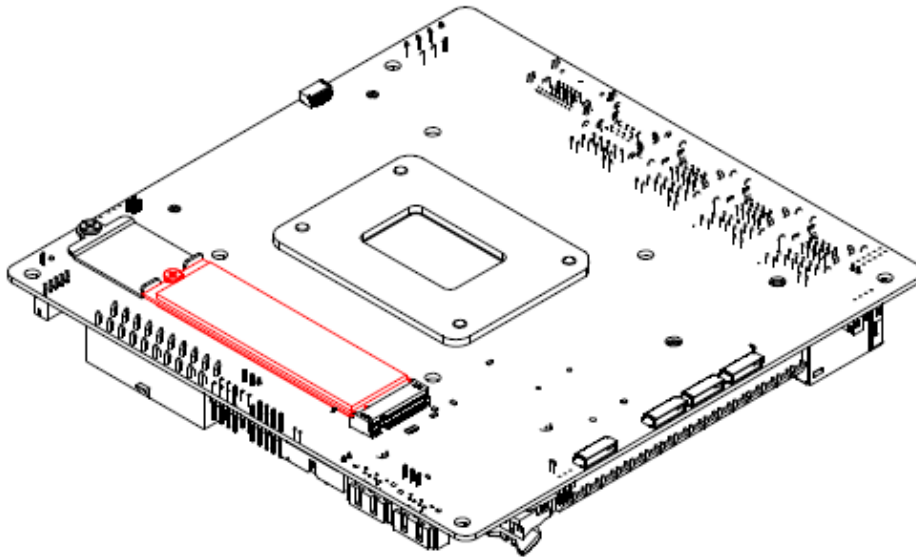

7. IPMI User Manual

7.1 Initial Screen

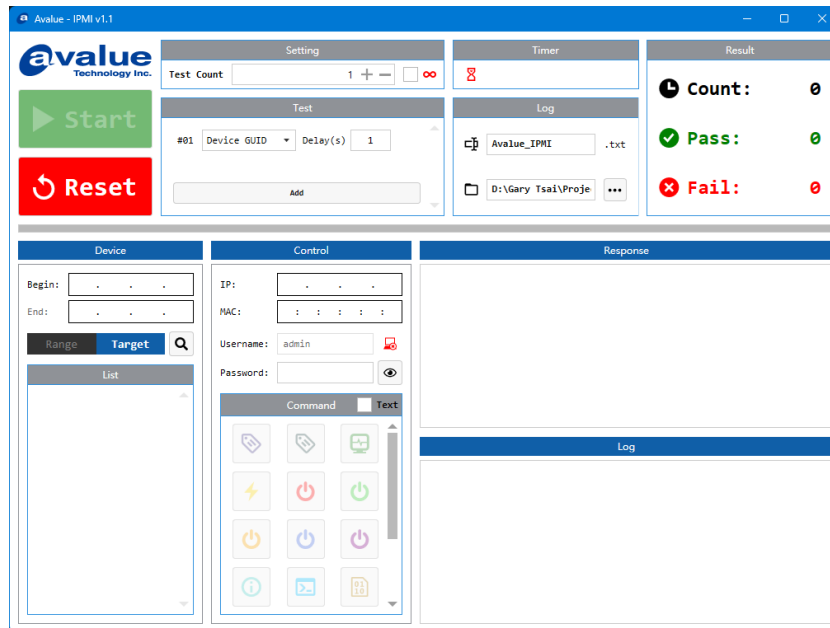

7.2 About Window

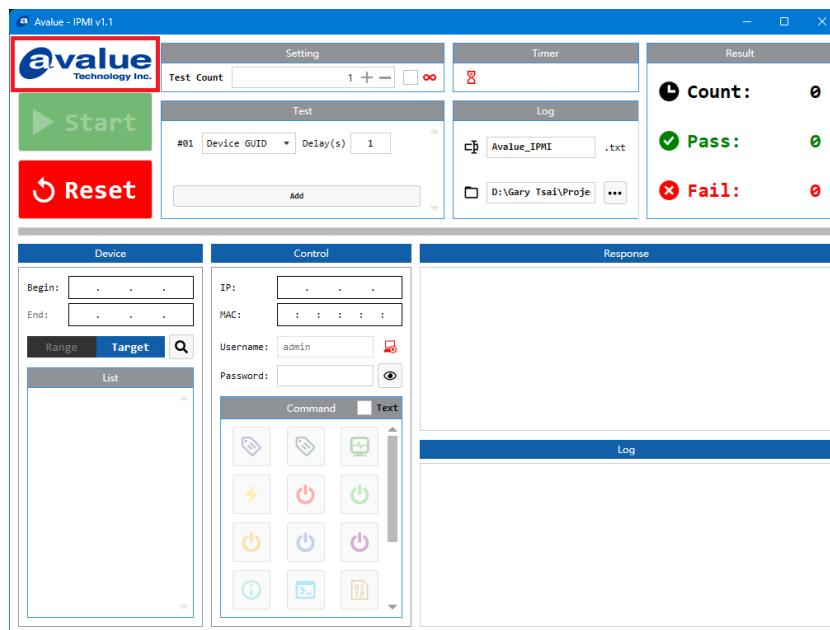

EMX-W880P User's Manual

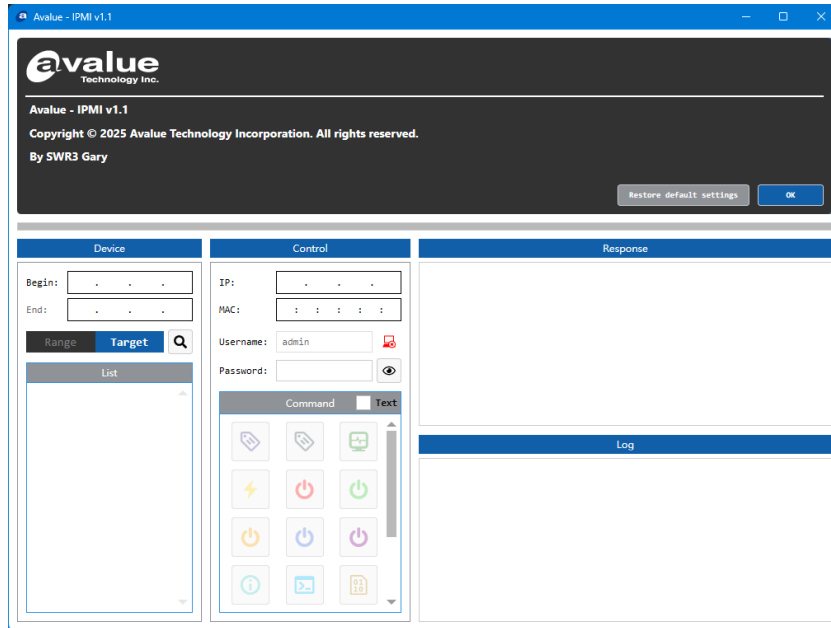

- Click “Avalue Logo”
- Click “Restore default settings” to reset all settings and records, then restart the program
 - * If the Loop Test is running, it will be forcibly stopped
- Click “OK” or press “ESC” to close the About window

7.3 Start/Stop/Reset

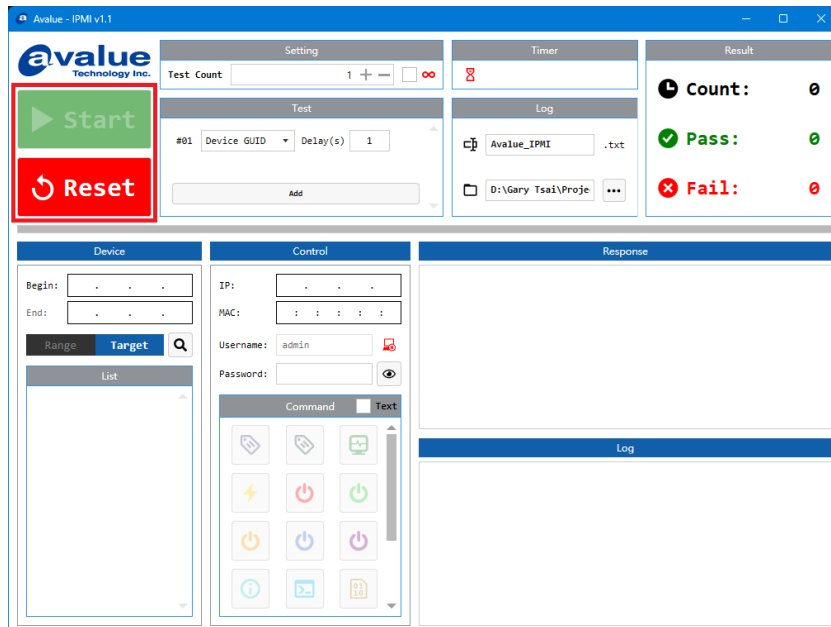

- Click “Start” to begin the Loop Test
 - * Enabled after entering values in the IP and Password fields
- Click “Stop” to halt the currently running process
 - * During the Loop Test, IPMI device search, or command execution, the “Reset” button

temporarily changes to **“Stop”**; it reverts once the process is manually stopped or completed

- Click **“Reset”** to clear all counts, response data, and log records generated by the Loop Test

7.4 Set the number of Loop Test iterations

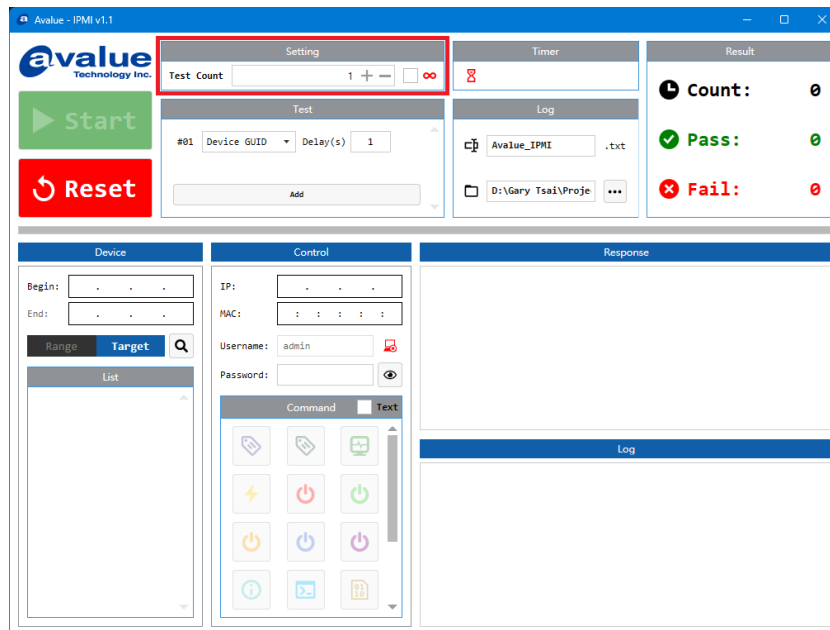

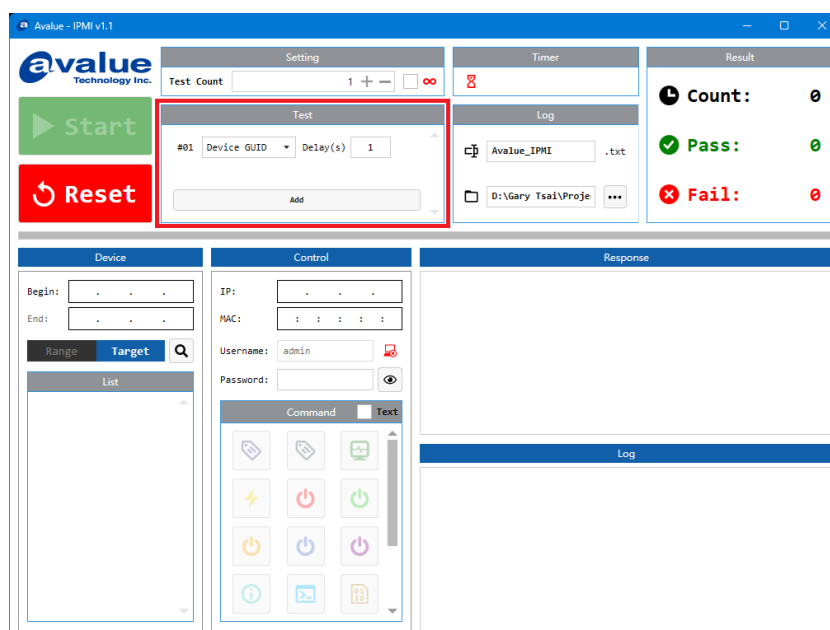

- The configurable range is **1 ~ 2147483647**
- Selecting **“∞”** indicates no limit

7.5 Configure Loop Test items

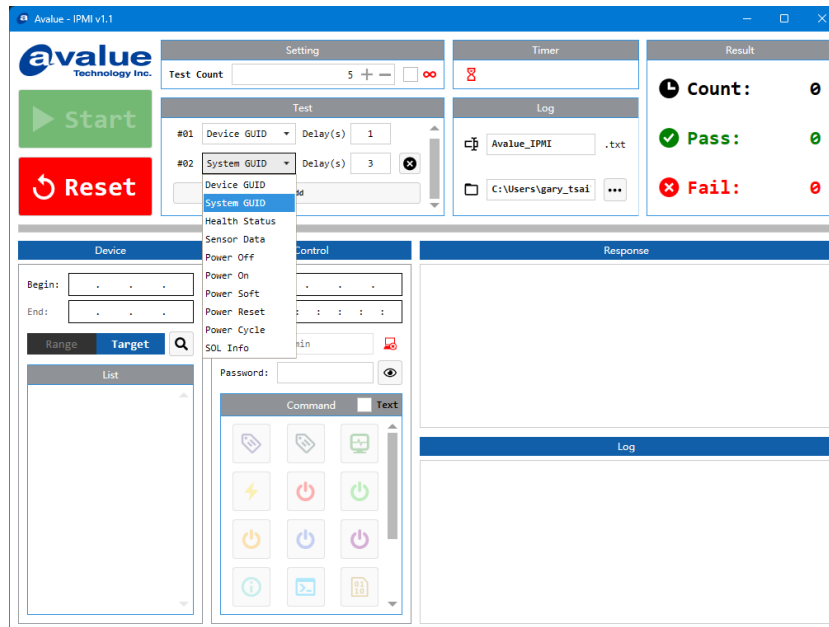

EMX-W880P User's Manual



- Use the dropdown menu to select the Command to be executed during the Loop Test
- Modify the input field value to adjust the Command execution time (in seconds)
 - * Used for setting the command interval and timeout mechanism
- Click “**Add**” to add a new Command for execution
- Click  to remove a Command
- Changes will only be saved after clicking “**Start**”

7.6 Countdown timer for the Command execution or the current Loop Test status

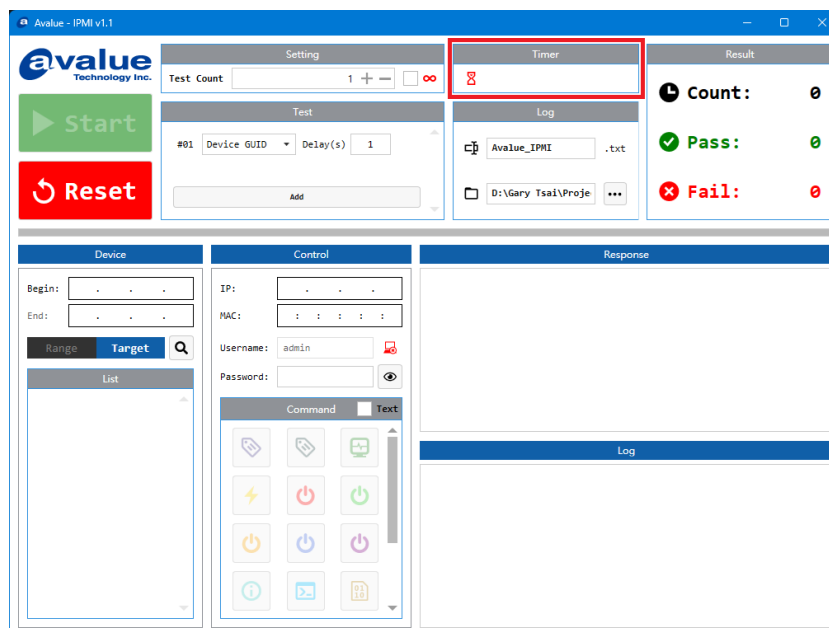

7.7 Response and log records generated by the Loop Test

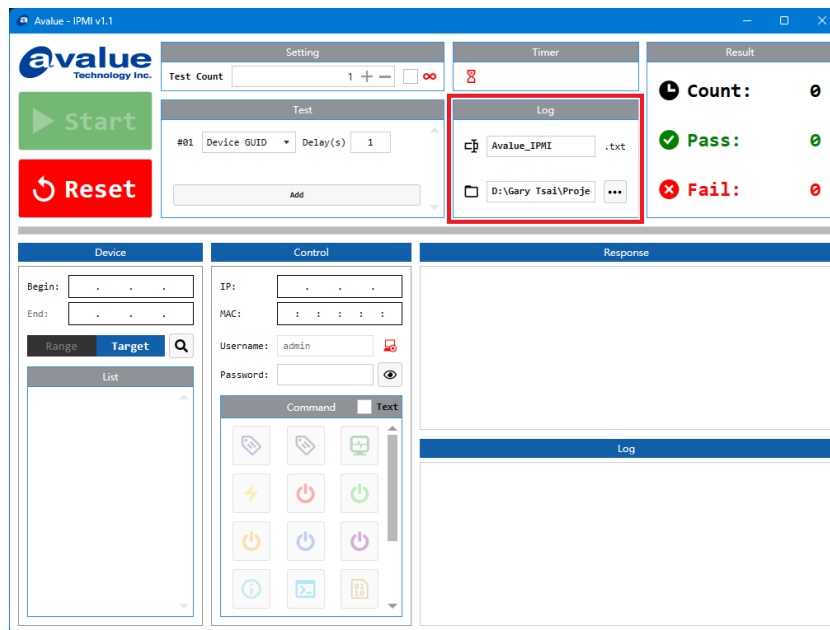

- The file name can be modified
 - The file path can be selected
- * After starting the Loop Test, these fields become uneditable and will only be editable again after resetting the records

7.8 Number of completed Loop Tests

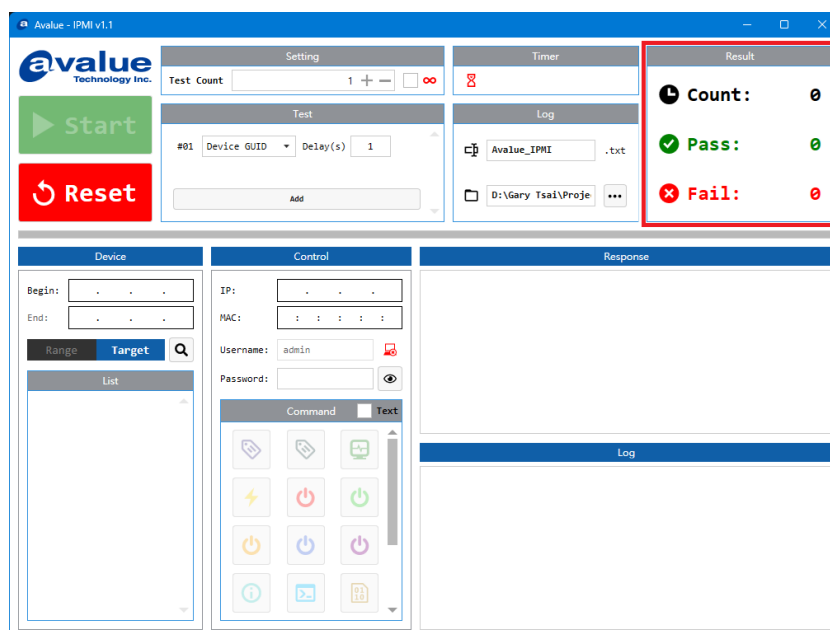

- Count = Pass + Fail

7.9 Search for / verify IPMI devices

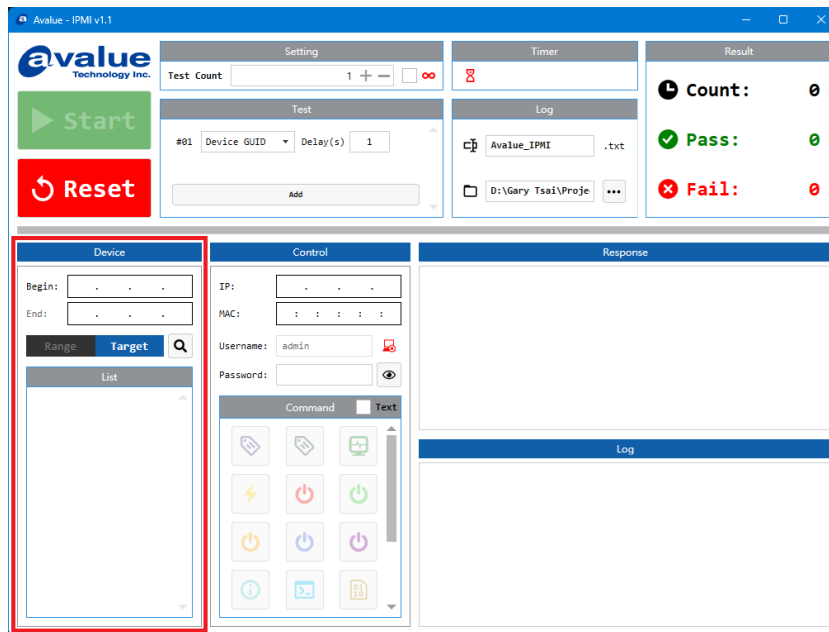

- Enter the starting IP address or a specific IP in the “**Begin**” field
- Enter the ending IP address in the “**End**” field
 - * Enabled after selecting “**Range**”
- Select “**Range**” to search within a range of IP addresses
- Select “**Target**” to search for a specific IP address
- Click  to start scanning

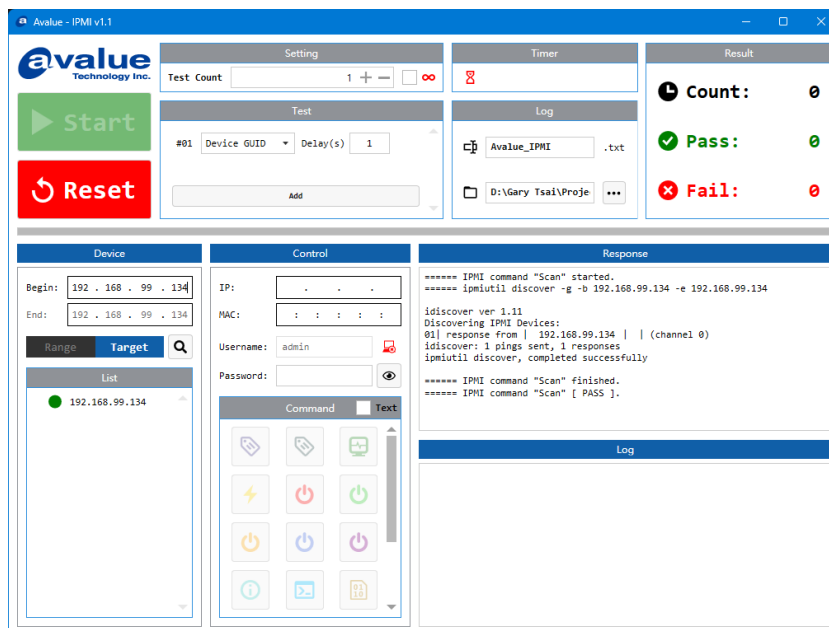

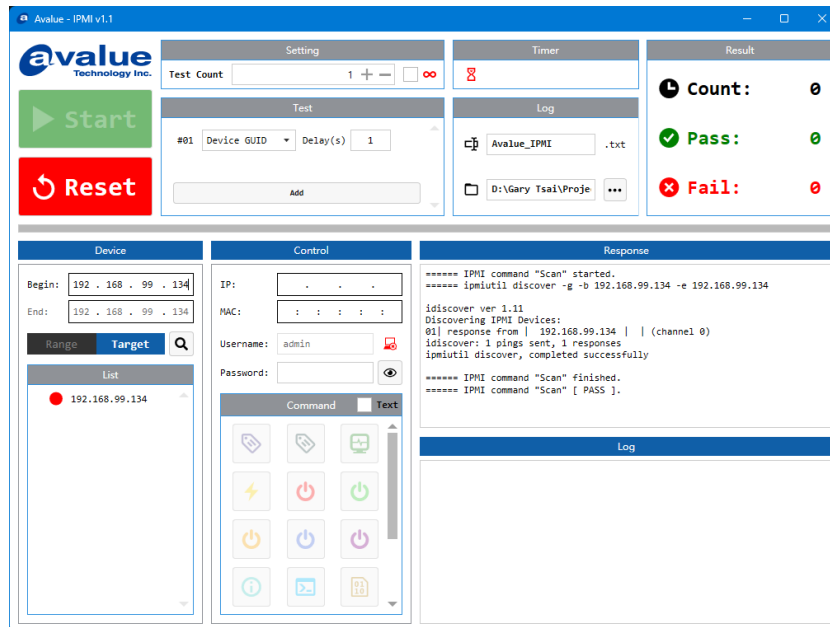

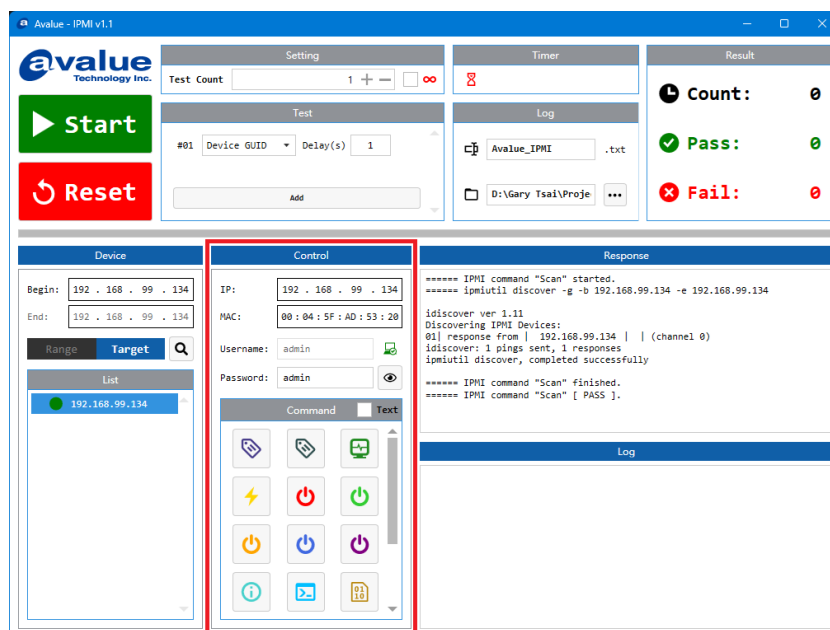

- The List displays the devices found during the search and dynamically updates their connection status afterward
 - indicates the device is connected
 - indicates the device is disconnected
- Clicking an item in the List will automatically fill the IP and MAC fields in the Control section
 - * The MAC address is retrieved only if the device is connected

7.10 Verify / control IPMI devices



- Enter the device's IP address in the "IP" field for testing or control
 - * It can also be auto-filled by selecting an item from the List

EMX-W880P User's Manual

- The “MAC” field is read-only and for verification only
 - * It is auto-filled from the List selection
- The “**Username**” field is read-only and defaults to admin
- The “**Password**” field defaults to admin
- When the device’s IP and Password are entered correctly, the system will dynamically verify the device’s power status
 -  indicates the device is powered on (S0)
 -  indicates the device is powered off (S5)

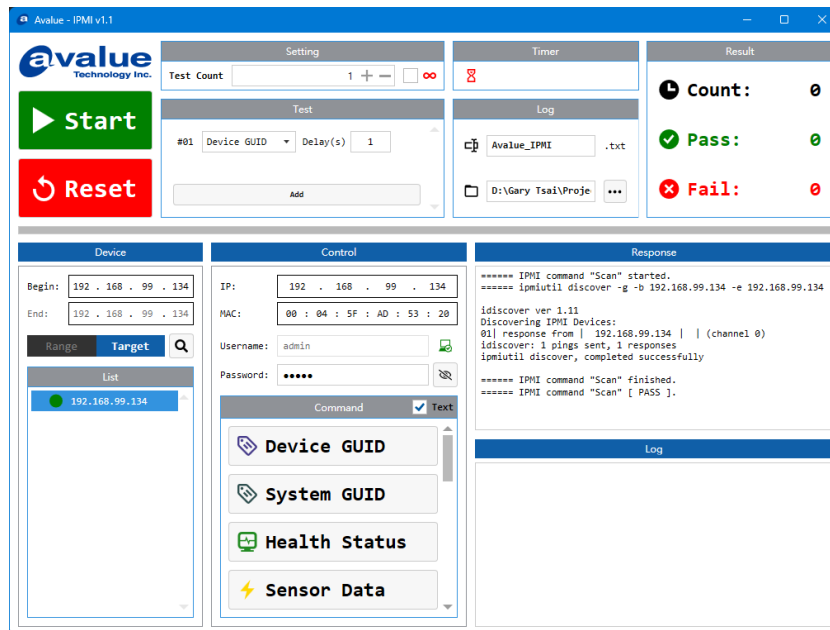

- Click  to show or hide the Password
- The Command list includes both basic and custom commands
 - * Enabled after entering values in the **IP** and **Password** fields
- Check “**Text**” to show or hide the Command button labels

7.11 Display of results returned from Loop Test, IPMI device search, or command execution

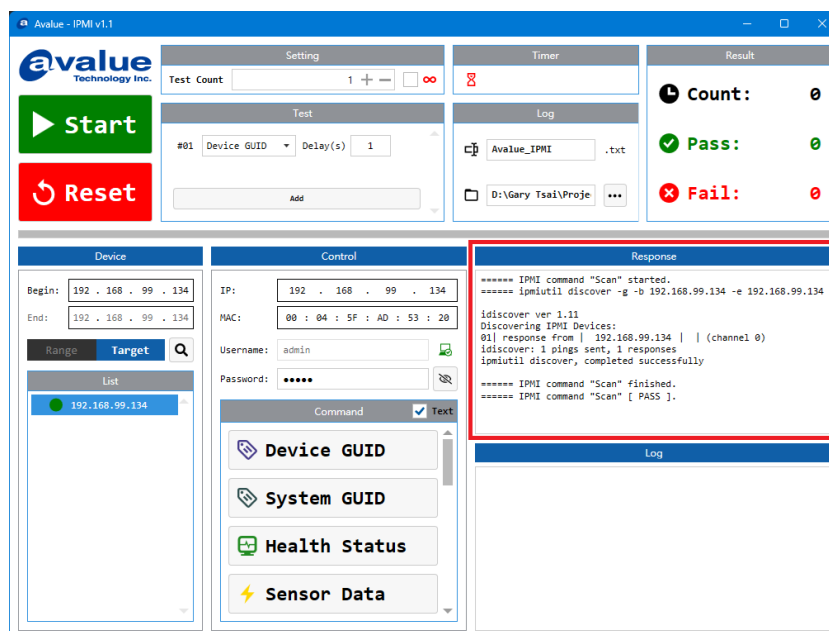

```
==== IPMI command "Scan" started.
==== ipmiutil discover -g -b 192.168.99.134 -e 192.168.99.134
```

```
idiscover ver 1.11
Discovering IPMI Devices:
01| response from | 192.168.99.134 | | (channel 0)
idiscover: 1 pings sent, 1 responses
ipmiutil discover, completed successfully
```

```
==== IPMI command "Scan" finished.
==== IPMI command "Scan" [ PASS ].
```

- Response Content Format
- The green sections at the top and bottom indicate the command execution status and the actual command sent.
- The red section in the middle displays the data returned by the IPMI.

EMX-W880P User's Manual

7.12 Device GUID

Globally unique identifier assigned to the specific hardware device

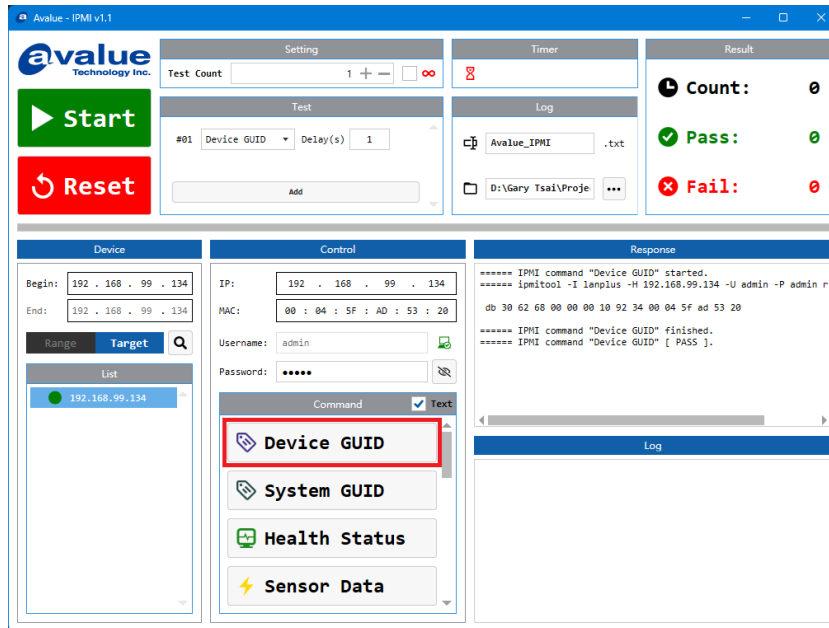

7.13 System GUID

Globally unique identifier representing the entire system or motherboard

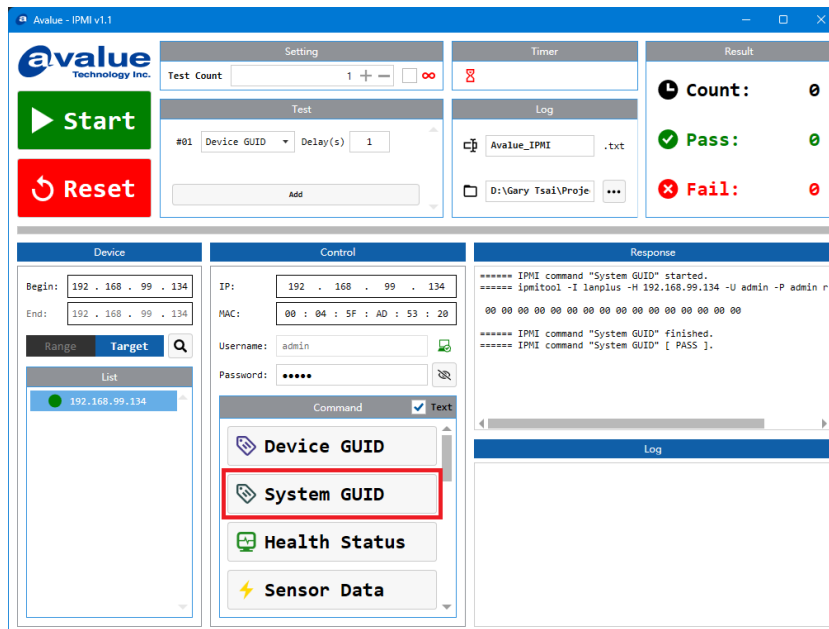

7.14 Health Status

System health status monitoring

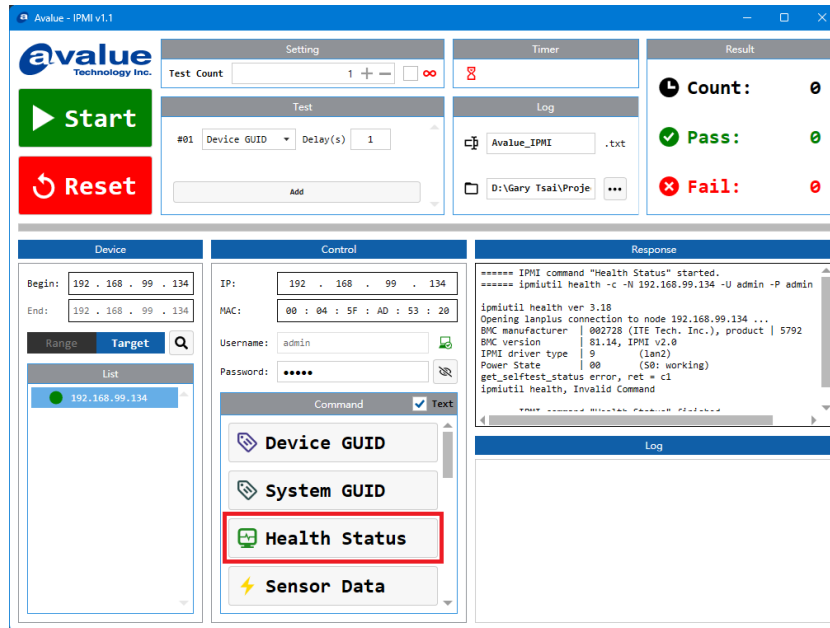

7.15 Sensor Data

Sensor readings

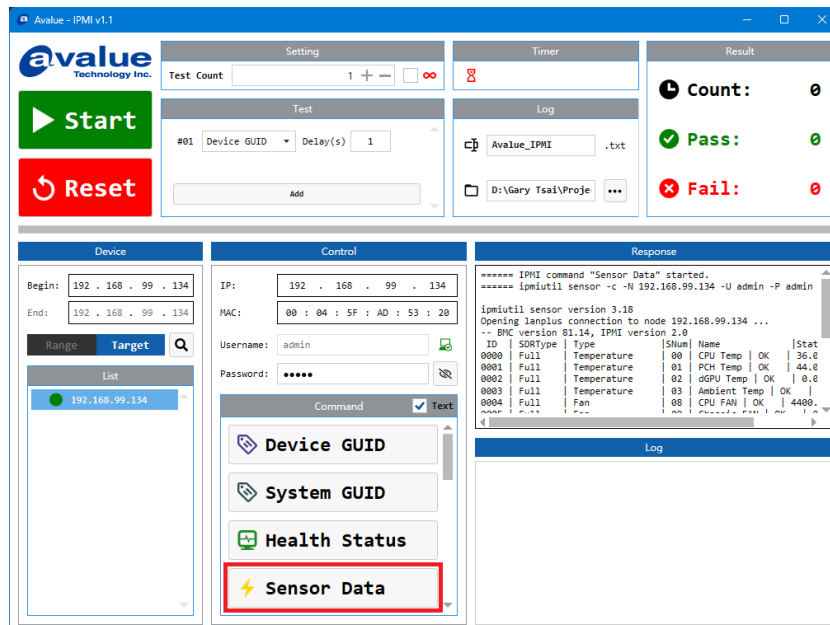

EMX-W880P User's Manual

7.16 Power Off

Power off the system

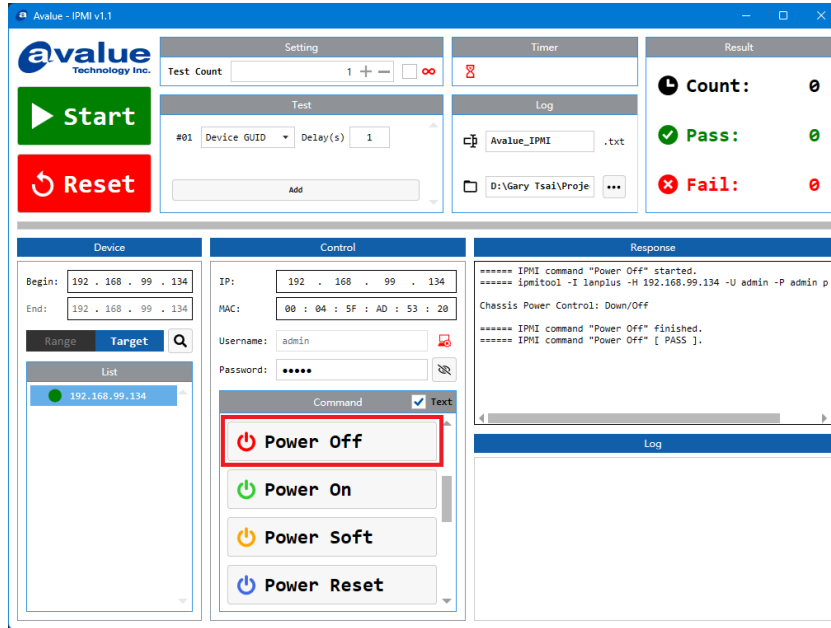

7.17 Power On

Power on the system

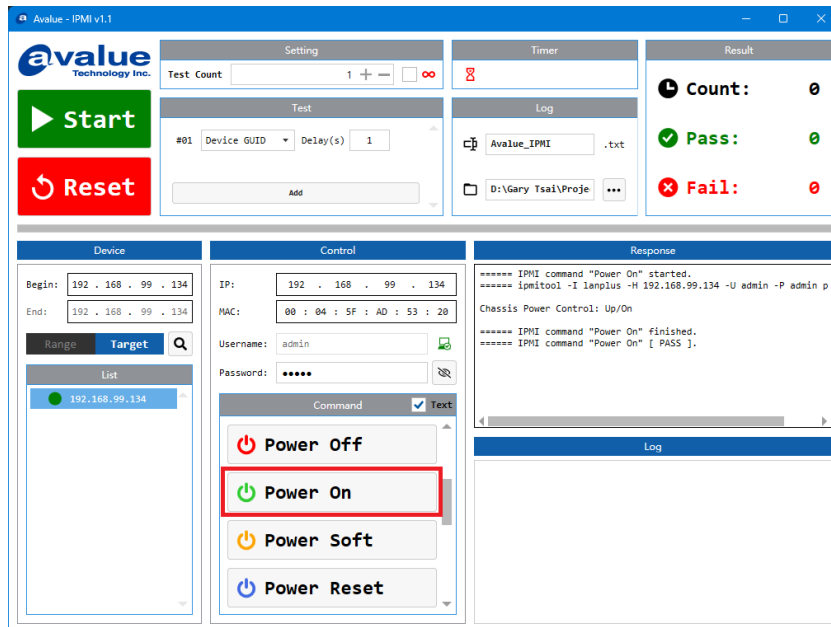

7.18 Power Soft

ACPI shutdown the system

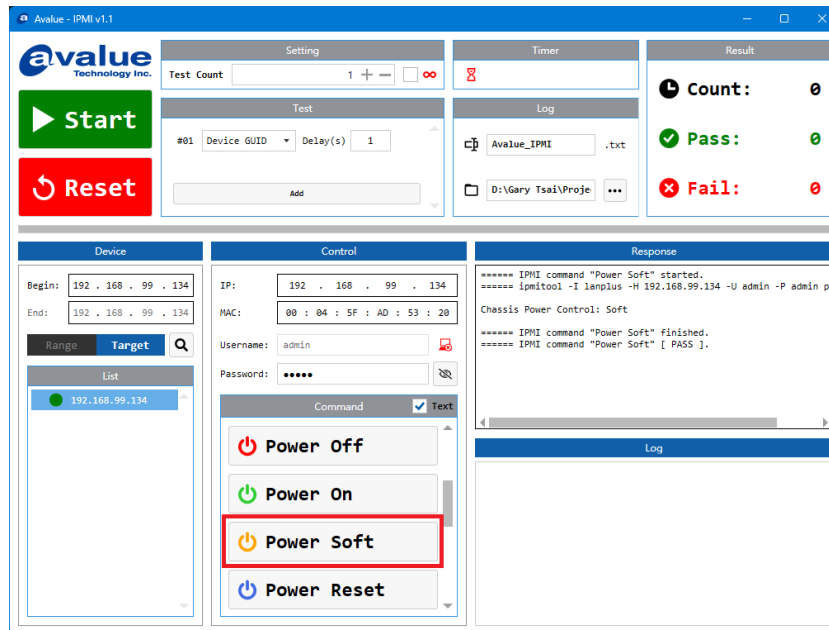

7.19 Power Reset

Hard reset the system

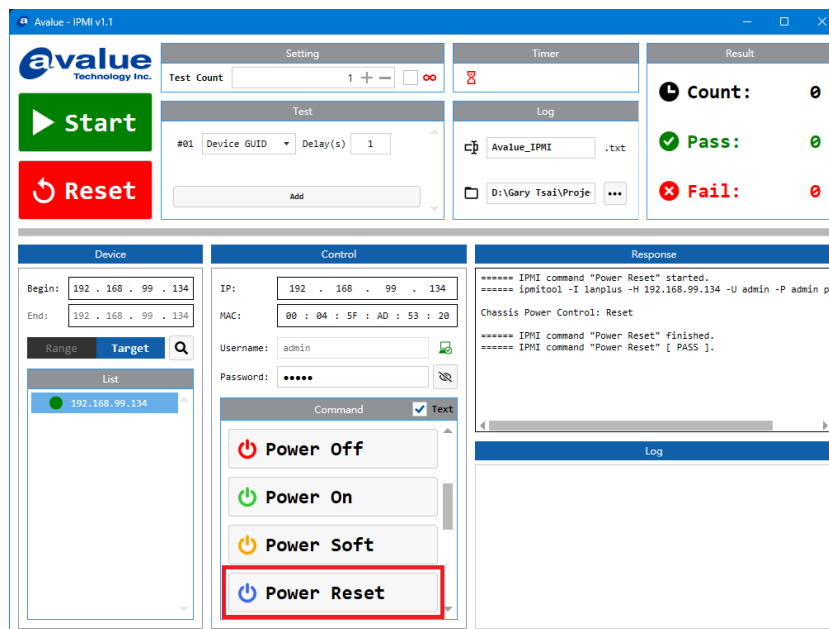

EMX-W880P User's Manual

7.20 Power Cycle

Power cycle the system

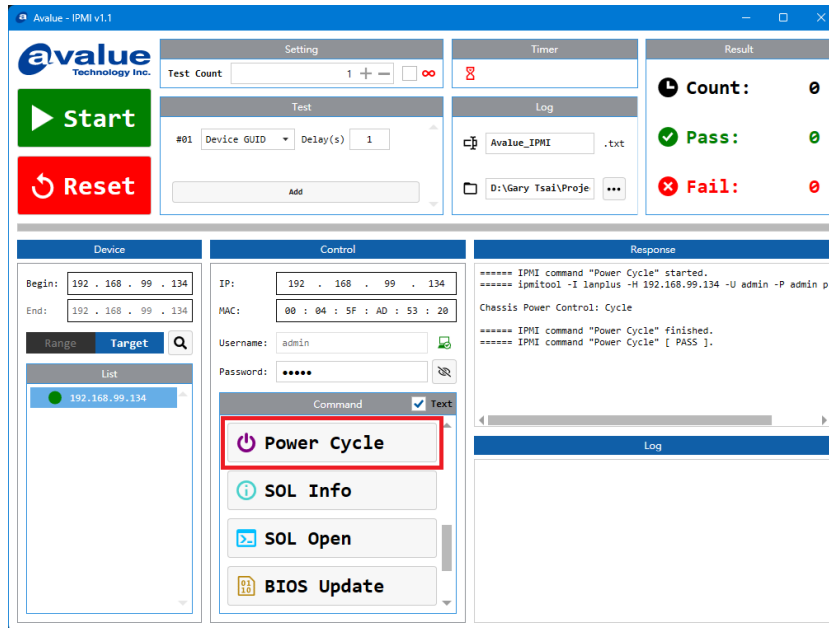

7.21 SOL Info

Serial over LAN information

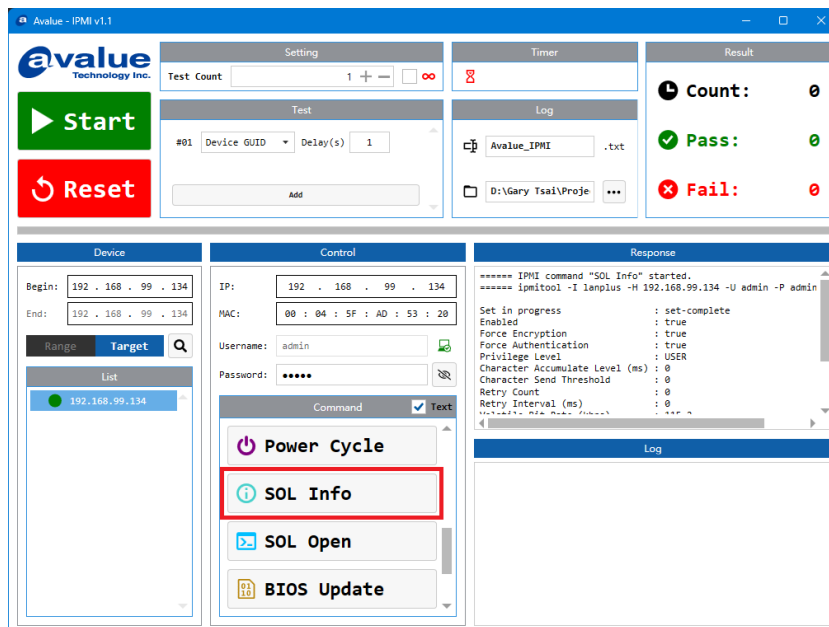

7.22 SOL Open

Open Serial over LAN connection

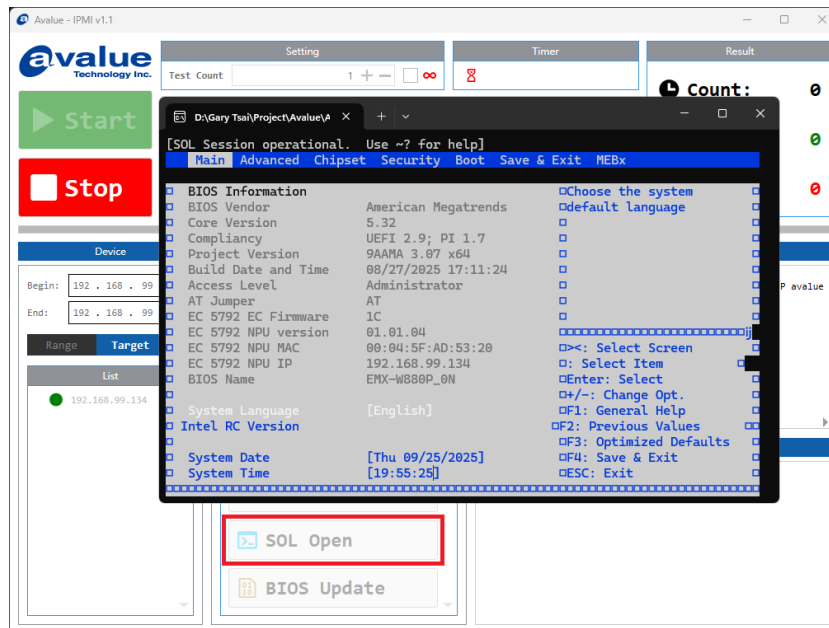

7.23 BIOS Update

Update BIOS via HPM file

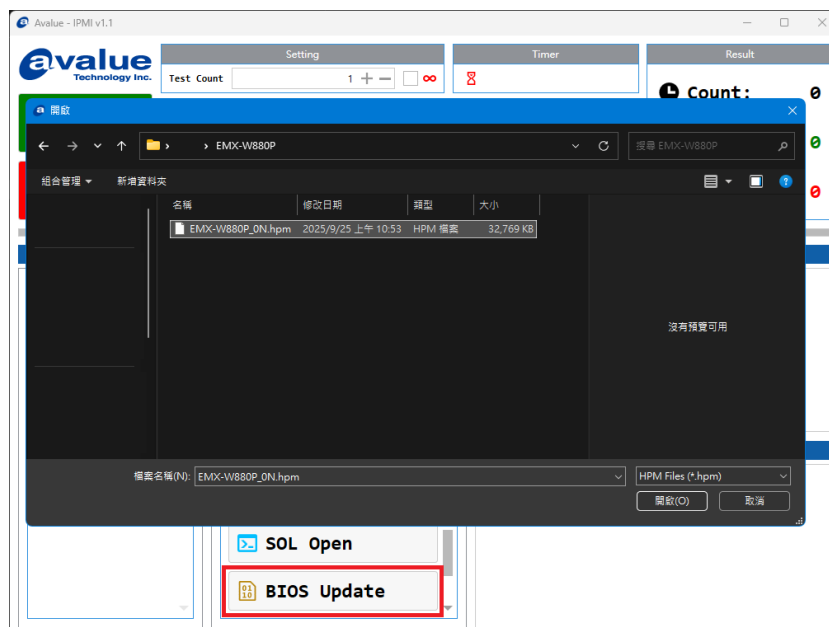

EMX-W880P User's Manual

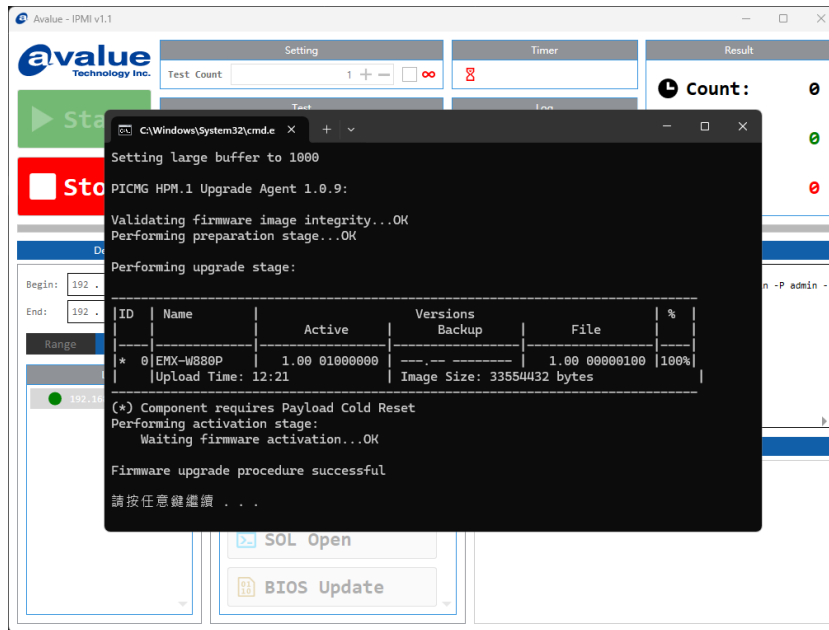

7.24 Change Password

Change the account password

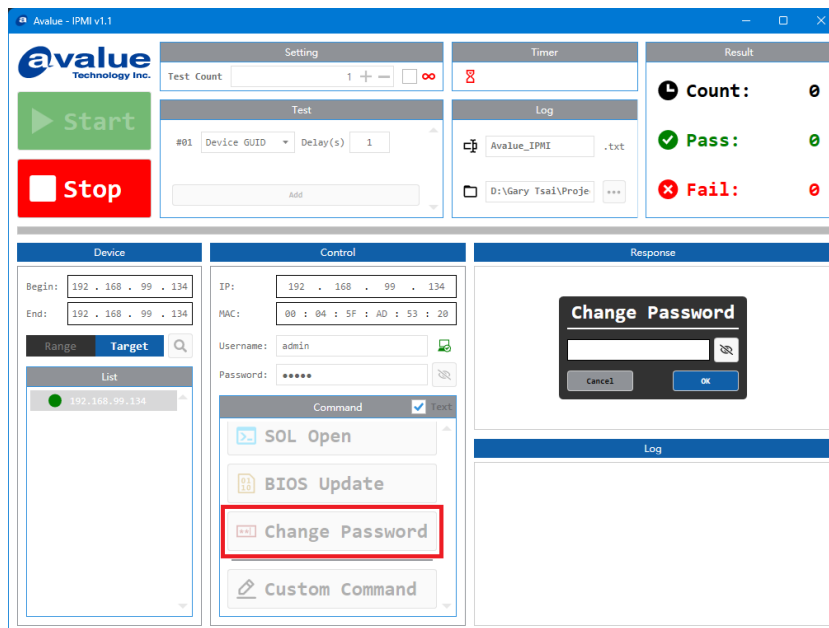

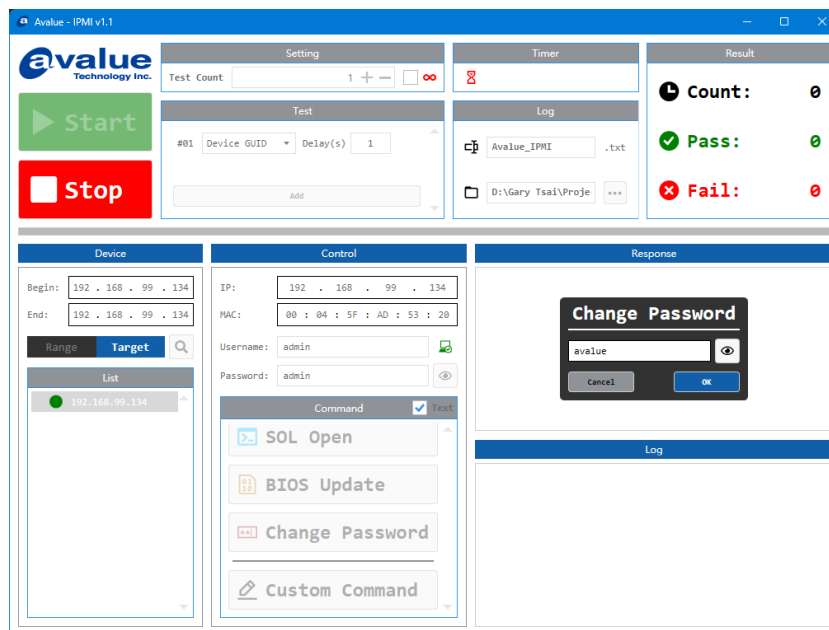

- Click  to show or hide the Password
* This is synchronized with the Password field status in the Control section
- Click “Cancel” or press “ESC” to cancel
- Click “OK” or press “Enter” to execute the Command

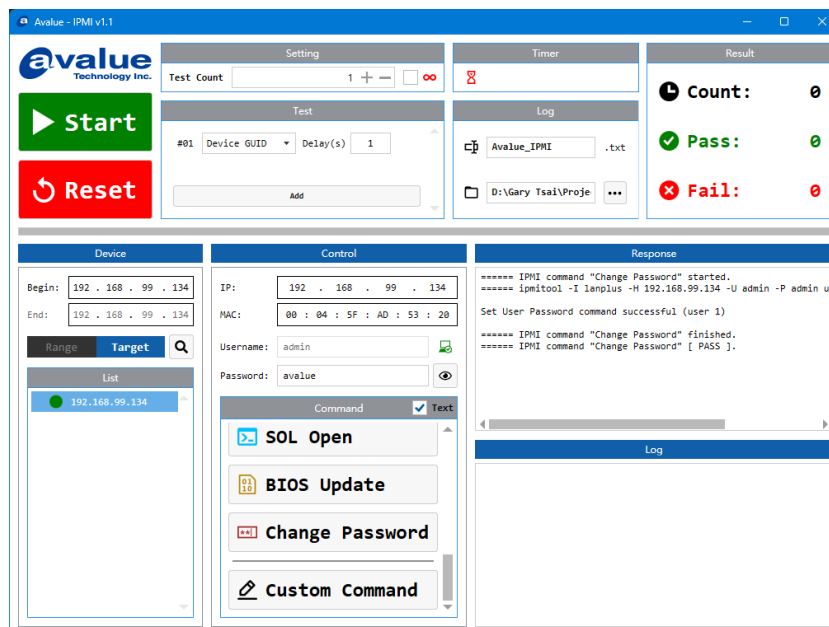

- After the Command executes successfully, the Password field in the Control section will be updated accordingly.

EMX-W880P User's Manual

7.25 Custom Command

Execute custom command

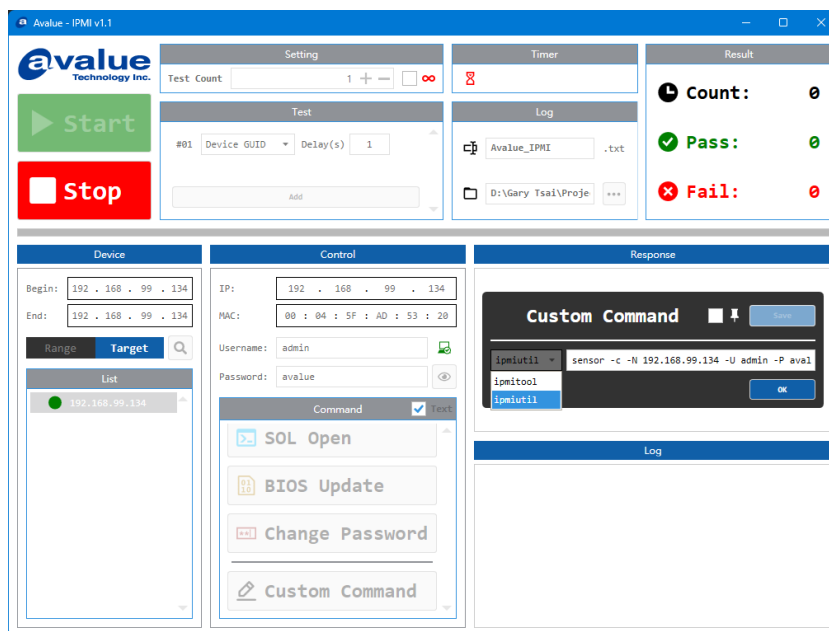
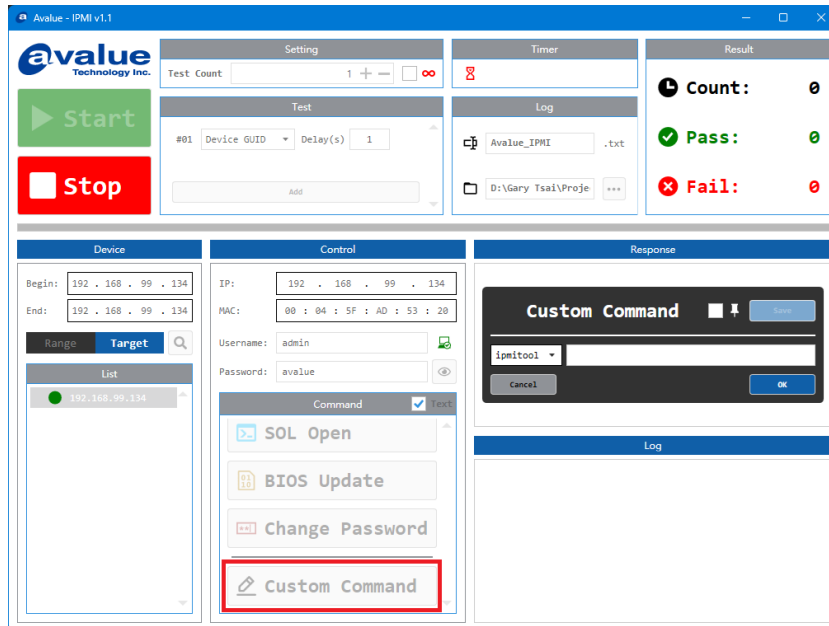

- Use the dropdown menu to select the **IPMI tool**
- Enter the **IPMI Command** in the input field
- Click **“Cancel”** or press **“ESC”** to cancel
- Click **“OK”** or press **“Enter”** to execute the Command

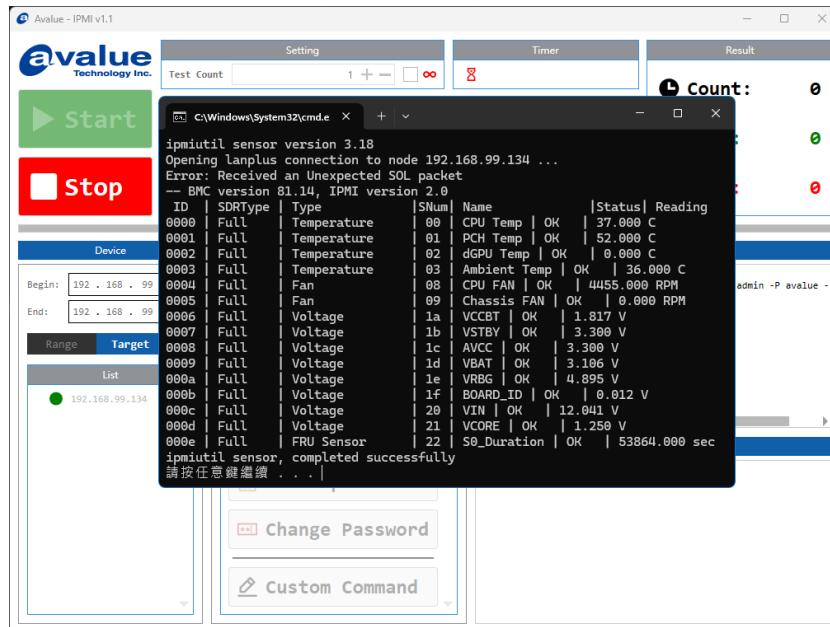

- The result of a custom command will be displayed in a new window

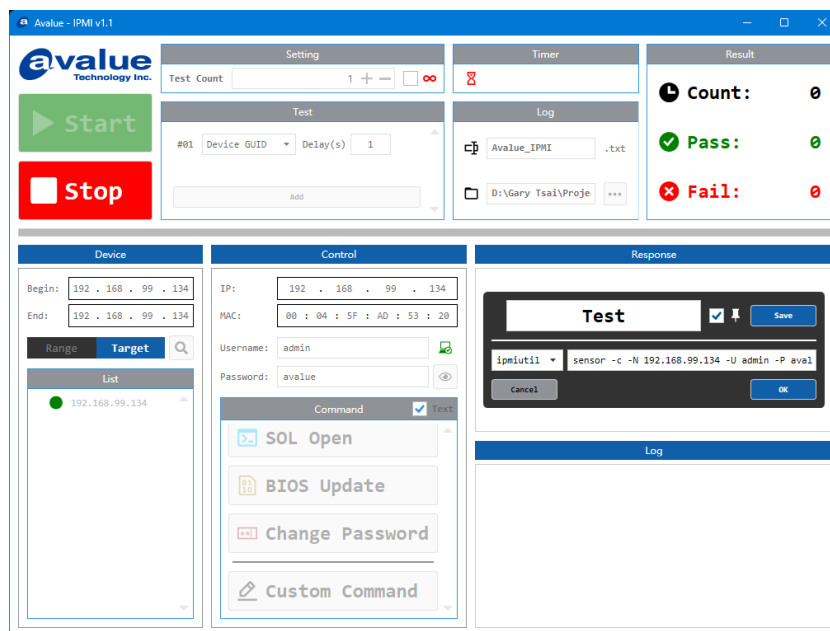

- Click  to enable the custom command save function
- The input field allows editing the custom command button text
 - * You can enter 0 to 15 characters
- Click **“Save”** to store the custom command

EMX-W880P User's Manual

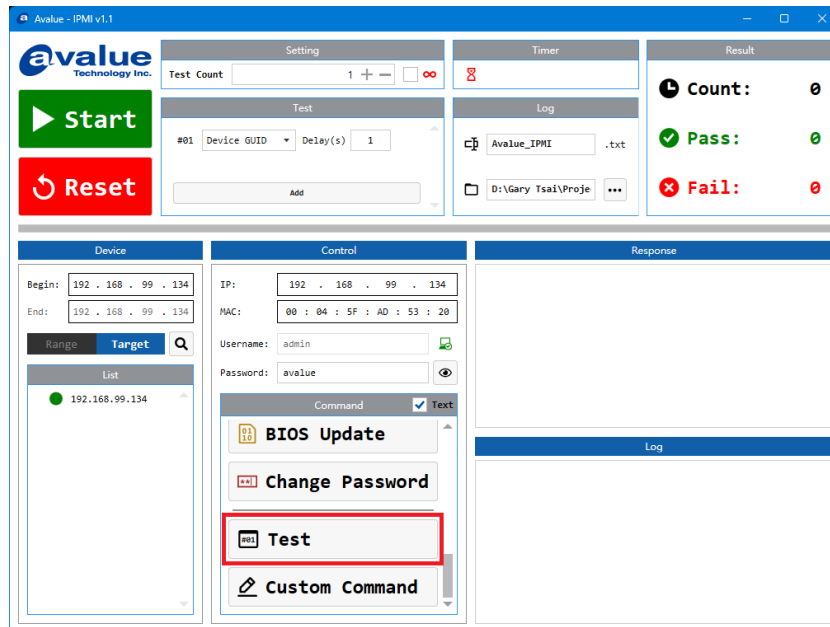

- The saved custom commands will be displayed before the “**Custom Command**” section

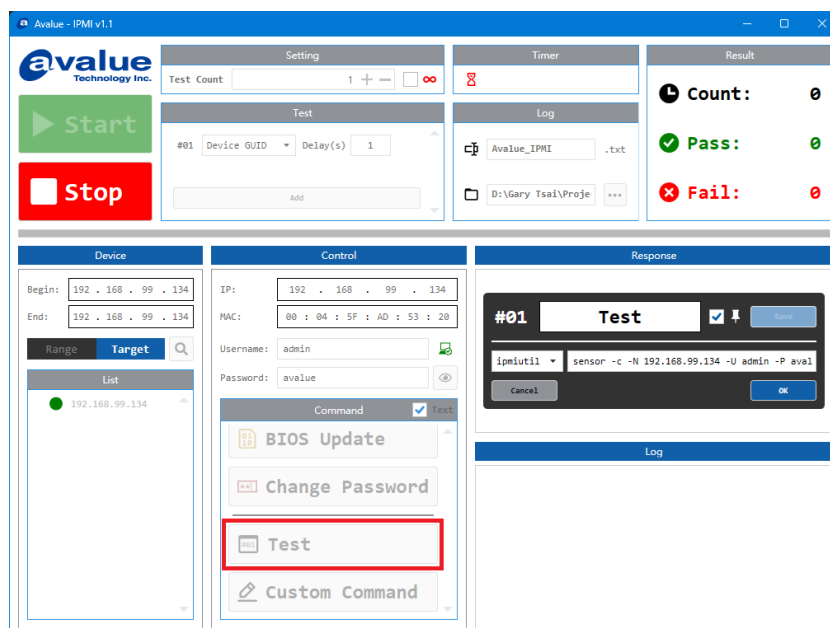

- Clicking a saved custom command will additionally display its index number
- Click “**Cancel**” or press “**ESC**” to cancel
- Click “**OK**” or press “**Enter**” to execute the Command

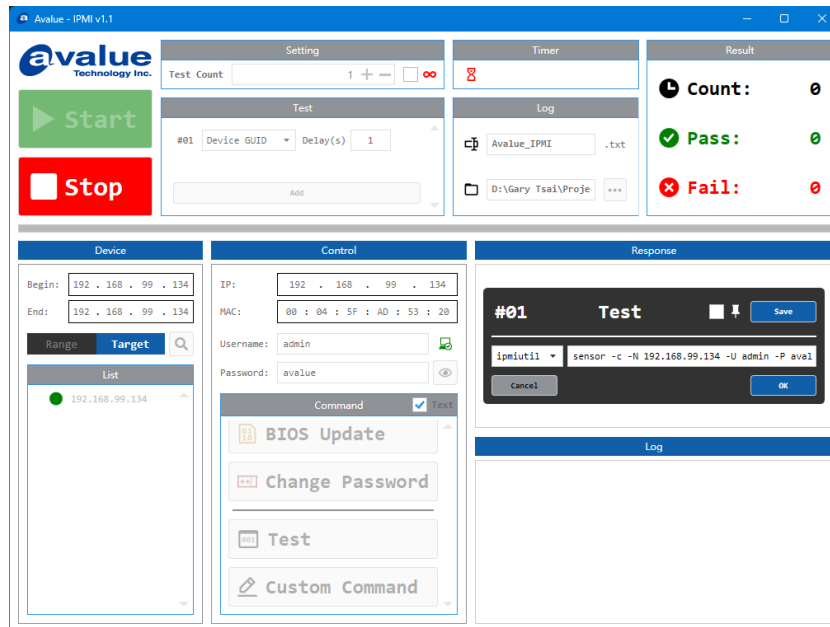

- When any changes are made to a custom command, the “Save” button becomes enabled
 - * Clicking the button will update the custom command content
 - * If the change includes unchecking the option, it will be treated as deleting the custom command

7.26 Loop Test

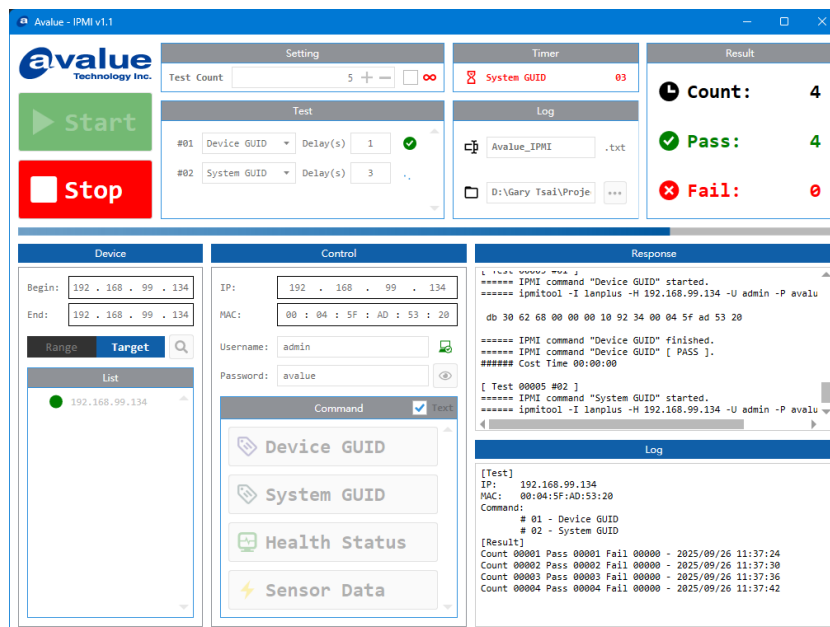

EMX-W880P User's Manual

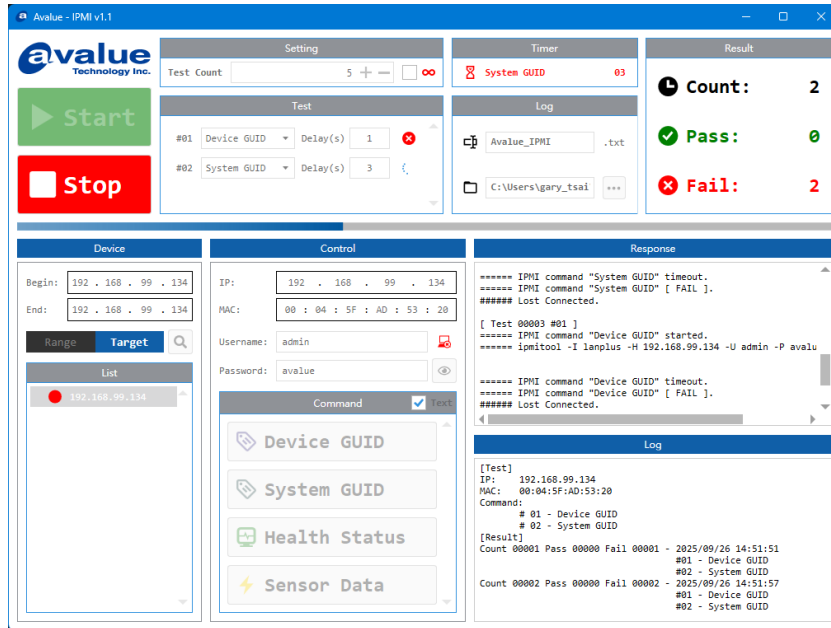

- Most functions will be disabled during testing
 - * Only “Avalue Logo” and “Stop” buttons remain clickable
- Each test item will display its execution status
 - indicates successful execution
 - indicates execution failure

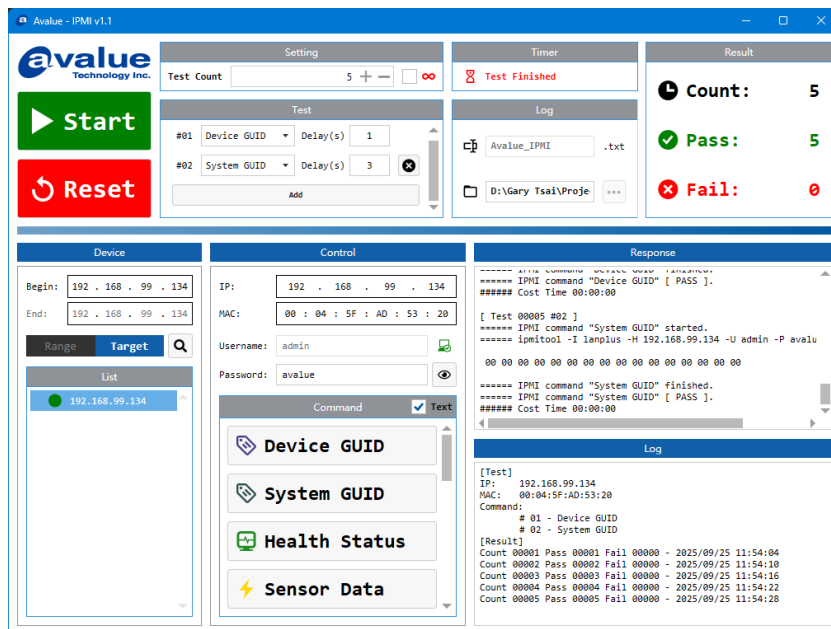

```
[ Test 00001 #01 ]  
IPMI command "Device GUID" started.  
===== ipmitool -I lanplus -H 192.168.99.134 -U admin -P admin raw 0x06  
  
db 30 62 68 00 00 00 10 92 34 00 04 5f ad 53 20  
  
===== IPMI command "Device GUID" finished.  
===== IPMI command "Device GUID" [ PASS ].  
##### Cost Time 00:00:00
```

- The Response content will be updated after each test item is completed, with slight differences from the previous format
 - * Includes the loop test count and test item number
 - * Displays the actual time spent on each test item
- The **Log content** will be updated after completing **one full test loop**

