

NUC-RPU

13th Generation Intel® Raptor Lake-U Fanless Ultra Slim
System

Quick Reference Guide

2nd Ed –15 November 2024

Copyright Notice

Copyright © 2024 Avalue Technology Inc., ALL RIGHTS RESERVED.

Document Amendment History

Revision	Date	By	Comment
1 st	June 2024	Avalue	Initial Release
2 nd	November 2024	Avalue	Remove 2.2 Power On the System 2.3 Connecting to Power Supply

Declaration of Conformity



This device complies with part 15 fcc rules. Operation is subject to the following two conditions:

(1) This device may not cause harmful interference.

(2) This device must accept any interference received including interference that may cause undesired operation.

This equipment has been tested and found to comply with the limits for a class "a" digital device, pursuant to part 15 of the fcc rules.

These limits are designed to provide reasonable protection against harmful interference when the equipment is operated in a commercial environment. This equipment generates, uses, and can radiate radio frequency energy and, if not installed and used in accordance with the instruction manual, may cause harmful interference to radio communications.

Operation of this equipment in a residential area is likely to cause harmful interference in which case the user will be required to correct the interference at his own expense.

CE statement

The product(s) described in this manual complies with all application European Union (CE) directives if it has a CE marking. For computer systems to remain CE compliant, only CE-compliant parts may be used. Maintaining CE compliance also requires proper cable and cabling techniques.

Notice

This guide is designed for experienced users to setup the system within the shortest time. For detailed information, please always refer to the electronic user's manual.

Copyright Notice

© 2024 by Avalue Technology Inc. All rights are reserved. No parts of this manual may be copied, modified, or reproduced in any form or by any means for commercial use without the prior written permission of Avalue Technology Inc. All information and specification provided in this manual are for reference only and remain subject to change without prior notice.

Acknowledgements

Intel and Pentium are trademarks of Intel Corporation.

Microsoft Windows is registered trademark of Microsoft Corp.

All other product names or trademarks are properties of their respective owners.

Disclaimer

This manual is intended to be used as a practical and informative guide only and is subject

NUC-RPU

to change without notice. It does not represent a commitment on the part of Avalue. This product might include unintentional technical or typographical errors. Changes are periodically made to the information herein to correct such errors, and these changes are incorporated into new editions of the publication.

A Message to the Customer

Avalue Customer Services

Each and every Avalue's product is built to the most exacting specifications to ensure reliable performance in the harsh and demanding conditions typical of industrial environments. Whether your new Avalue device is destined for the laboratory or the factory floor, you can be assured that your product will provide the reliability and ease of operation for which the name Avalue has come to be known.

Your satisfaction is our primary concern. Here is a guide to Avalue's customer services. To ensure you get the full benefit of our services, please follow the instructions below carefully.

Technical Support and Assistance

1. Visit the Avalue website at <https://www.avalue.com/> where you can find the latest information about the product.
2. Contact your distributor or our technical support team or sales representative for technical support if you need additional assistance. Please have following information ready before you call:
 - Product name and serial number
 - Description of your peripheral attachments
 - Description of your software (operating system, version, application software, etc.)
 - A complete description of the problem
 - The exact wording of any error messages

To receive the latest version of the user's manual; please visit our Web site at:

www.avalue.com

Product Warranty (Returns & Warranties policy)

1. Purpose

Avalue establishes the following maintenance specifications and operation procedures for providing the best quality of service and shortened repair time to our customers.

2. Warranty

2.1 Warranty Period

Avalue endeavors to offer customers the most comprehensive post-sales services and protection; besides offering a 2-year warranty for standard Avalue products, an extended warranty service can also be provided based on additional request from the customer.

Within the warranty period, customers are entitled to receive comprehensive and prompt repair and warranty.

Standard products manufactured by Avalue are offered a 2-year warranty, from the date of delivery from Avalue. For ODM/OEM products manufactured by Avalue or PCBA with conformal coating, will follow up the define warranty of the agreement, otherwise will be offered 1-year warranty for ODM/OEM products but non-warranty for PCBA with conformal coating. For outsourcing parts kit by Avalue (ex: Motherboard, LCD touch panel, CPU, RAM, HDD) are offered a 6-month warranty, and Mobile/Tablet PC battery are offered a warranty of the half year, from the date of delivery by Avalue. Products before the mass production stage, i.e. engineering samples are not applied in this warranty or service policy. For extended warranty and cross-territory services, product defects resulting from design, production process or material are covered by the pre-set warranty period after the date of delivery from Avalue. For non-Avalue products, the product warranty and repair time shall be based on the service standards provided by the original manufacturer; in principle Avalue will provide these products a warranty service for no more than one year.

2.2 Maintenance services within the warranty period

In the case of Avalue product DOA (Defect-on-Arrival) when the customer finds any defect within 1 month after the delivery, Avalue will replace it with a new product in a soonest way. Except for custom products, once the customer is approved of a Cross-Shipment Agreement, which allows for delivery a new product to the customer before receiving the defective one, Avalue will immediately proceed with new product replacement for the said DOA case. On validation of the confirmed defect, Avalue is entitled to reserve the right whether to provide a new product for replacement. For the returned defective new product, it is necessary to verify that there shall be no bruise, alteration, scratch or marking to the appearance, and that none of the delivered accessories missing; otherwise, the customer will be requested to pay a processing fee. On the other hand, if the new product defect is resulting from incorrect configuration or erroneous use by the user instead of any problem of the hardware itself, the customer will also be requested to pay for relevant handling fees.

NUC-RPU

As for other conditions, Avalue will handle defects by way of repair. The customer will be requested to send the defective product to an Avalue authorized service center, and Avalue will return the repaired product back to the customer as soon as possible.

2.3 Ruling of an out-of-warranty defect

The following situations are not included in the warranty:

- The warranty period has expired.
- Product has been altered or its label of the serial number has been torn off.
- Product functionality issues resulting from improper use by the user, unauthorized dismantle or alteration, unfit operation environment, improper maintenance, accident or other causes. Avalue reserves the right for the ruling of the aforementioned situations.
- Product damage resulting from lightning, flood, earthquake or other calamities.
- The warranty rules of non-Avalue products and accessories shall be in accordance with standards set up by the original manufacturer. These products and accessories include RAM, HDD, FDD, CD-ROM, CPU, FAN, etc.
- Product upgrade request or test request submitted by the customer after expiration of the warranty.
- PCBA with conformal coating.
- Avalue semi-product and outsourced products without Avalue serial number.
- Products before the mass production stage, i.e. engineering samples.

3. Procedure for sending for repair

3.1 Attain a RMA number

A customer's rejected product returned for repair shall have a RMA (Return Merchandise Authorization) number. Without a RMA number, Avalue will not provide any repair service for the rejected product, and the product will be returned to the customer at customer's cost. Avalue will not issue any notice for the return of the product.

Each returned product for repair shall have a RMA number, which is simply the authorization of the return for repair; it is not a guarantee that the returned goods can be repaired or replaced. For applying for a RMA number, the customer may enter the eRMA webpage of Avalue <https://www.avalue.com/en/member> and log-in with an account number and a password authorized by Avalue. The system will then automatically issue a RMA number.

When applying for the RMA number, it is essential to fill in basic information of the customer and the product, together with detailed description of the problem encountered. If possible, avoid using ambiguous words such as "does not work" or "problematic". Without a substantial description of the problem, it is hard to start the repair and will cause prolonged repair time. Lacking detailed statement of fault steps also makes the problem hard to be identified, sometimes resulting in second-time repairs.

In case the customer can't define the cause of problem, please contact Avalue application engineers. Sometimes when the problem can be resolved even before the customer sends back the product.

On the other hand, if the customer only returns the key parts to Avalue for repair, it is necessary that the serial number of the entire unit is given in the "Problem Description" field, so that warranty period can be ruled accordingly; or Avalue will handle the case as an Out-of- warranty case.

3.2 Return of faulty product for repair

It is recommended that the customer not to return the accessories (manual, connection cables, etc.) with the products for repair, devices such as CPU, DRAM, CF memory card, etc., shall also be removed from the faulty goods before return for repair. If these devices are relevant to described repair problems and necessary to be returned with the goods; please clearly indicate the items included in the eRMA application form. Avalue shall not be responsible for any item that is not itemized. Moreover, make sure the problem(s) are detailed in the "Problem Description" field.

In the list of delivery, the customer may fill-in a value which is lower than the actual value, to prevent customs levying a higher tax over the excessive value of the return goods. The customer shall be held responsible for extra fees caused by this. We strongly recommend that "Invoice for customs purpose only with no commercial value" be indicated on the delivery note. Also for the purpose of expedited handling, please printout the RMA number and put it in the carton, also indicate the number outside of the carton, with the recipient addressing to Avalue RMA Department.

When returning the defective product, please use an anti-static bag or ESD material to pack it properly. In case of improper packing resulting in damages in the transportation process, Avalue reserves the right to reject the un-repaired faulty good at the customer's costs. Furthermore, it is suggested that the faulty goods shall be sent via a door-to-door courier service. The customer shall be held responsible for any customs clearance fee or extra expenses if Air-Cargo is used for the delivery.

In case of a DOA situation of a new product, Avalue will be responsible for the product and the freight. If the faulty goods are within the warranty period, the sender will take responsibility for the freight. For an out-of-warranty case, the customer shall be responsible for the freight of both trips.

3.3 Maintenance Charge

Avalue will charge a moderate repair fee for the following conditions:

- The warranty period has expired.
- Product has been altered or its label of the serial number has been torn off.
- Product functionality issues resulting from improper use by the user, unauthorized dismantle or alteration, unfit operation environment, improper maintenance, accident

NUC-RPU

or other causes. Avalue reserves the right for the ruling of the aforementioned situations.

- Product damage resulting from lightning, flood, earthquake or other calamities.
- The warranty rules for non-Avalue products and accessories shall be in accordance with standards set up by the original supplier. These products and accessories include RAM, HDD, FDD, CD-ROM, CPU, FAN, etc.
- Product upgrade request or test request submitted by the customer after expiry of the warranty.
- PCBA with conformal coating.
- Avalue semi-product and outsourced products without Avalue serial number
- Products before the mass production stage, i.e. engineering samples.
- In case the products received are examined as NPF (No Problem Found) within the warranty period, the customer shall be responsible for the freight of both trips.
- Please contact your local distributor to examine in advance to prevent unnecessary freight cost.

For system failure of out-of-warranty products, Avalue will provide a quotation prior to repair service. When the customer applies for the cost, please refer to the Quotation number. In case the customer does not return the DOA product that has already been replaced by a new one, or the customer does not sign back the quotation of the out-of-warranty maintenance, Avalue reserves the right of whether or not to provide the repair service. In case the customer does not reply in 3 months, Avalue shall directly scrap or return the product back to customer at customer's cost without further notice to the customer.

3.4 Maintenance service of phased-out products

For servicing phased-out products, Avalue provides an extended period, starting the date of phase-out, as a guaranteed maintenance period of such products, for continuance of the maintenance service to meet customer's requirements. In case of unexpected factors causing Avalue to be unable to repair/replace a warranted but phased-out product, Avalue will, depending on the availability, upgrade the product (free of charge with continued warranty period as of the original product), or, give partial refund (based on the length of the remaining warranty period) to solve this kind of problem.

3.5 Maintenance Report

On completion of repair of a defective product, a Maintenance Report indicating the maintenance result and part(s) replaced (if any) will be sent to the customer together with the product. If the customer demands an additional maintenance analysis report, a service fee of various level will be charged depending on the warranty status. In case the analysis result shows that the defect attributes to Avalue's faulty design or process, the analysis fee will be exempted.

4. Service Products

Avalue provides service products to manage with different customer needs. Should you have any need, please consult to Avalue Sales Department.

Defect Analysis Report (DAR)

Avalue provides DAR (Defect Analysis Report) services aiming to elevating customer satisfaction. A DAR includes defect cause identification/verification/suggestion and improvement precautions, with instructions on correct usage for the avoidance of any reoccurrence.

Upgrade Service

Avalue is capable to provide system upgrade service for customization requirements. This upgrade service is applicable for main parts, such as CPU, memory, HDD, SSD, storage devices; also replacements motherboards of systems. Please contact Avalue sales for details to evaluate the possibility of system upgrade service and obtain information of lead time and price.

Safety Instructions

Safety Precautions

Before installing and using this device, please note the following precautions.

1. Read these safety instructions carefully.
2. Keep this User's Manual for future reference.
3. Disconnected this equipment from any AC outlet before cleaning.
4. For plug-in equipment, the power outlet socket must be located near the equipment and must be easily accessible.
5. Keep this equipment away from humidity.
6. Put this equipment on a reliable surface during installation. Dropping it or letting it fall may cause damage.
7. Make sure the voltage of the power source is correct before connecting the equipment to the power outlet.
8. Use a power cord that has been approved for using with the product and that it matches the voltage and current marked on the product's electrical range label. The voltage and current rating of the cord must be greater than the voltage and current rating marked on the product.
9. Position the power cord so that people cannot step on it. Do not place anything over the power cord.
10. All cautions and warnings on the equipment should be noted.
11. If the equipment is not used for a long time, disconnect it from the power source to

NUC-RPU

avoid damage by transient overvoltage.

12. Never pour any liquid into an opening. This may cause fire or electrical shock.











13. Never open the equipment. For safety reasons, the equipment should be opened only by qualified service personnel. If one of the following situations arises, get the equipment checked by service personnel:

- The power cord or plug is damaged.
- Liquid has penetrated into the equipment.
- The equipment has been exposed to moisture.
- The equipment does not work well, or you cannot get it work according to the user's manual.
- The equipment has been dropped and damaged.
- The equipment has obvious signs of breakage.





14. CAUTION: Danger of explosion if battery is incorrectly replaced. Replace only with the same or equivalent type recommended by the manufacturer.

15. Equipment intended only for use in a RESTRICTED ACCESS AREA.

Explanation of Graphical Symbols

	Warning	A WARNING statement provides important information about a potentially hazardous situation which, if not avoided, could result in death or serious injury.
	Caution	A CAUTION statement provides important information about a potentially hazardous situation which, if not avoided, may result in minor or moderate injury to the user or patient or in damage to the equipment or other property.
	Note	A NOTE provides additional information intended to avoid inconveniences during operation.
		Direct current.
		Alternating current
		Stand-by, Power on
		FCC Certification
		CE Certification
		Follow the national requirements for disposal of equipment.
		Stacking layer limit
		This side up

NUC-RPU

		Fragile Packaging
		Beware of water damage, moisture-proof
		Carton recyclable
		Handle with care
		Follow operating instructions of consult instructions for use.

Disposing of your old product

WARNING:

There is danger of explosion if the battery is mishandled or incorrectly replaced. Replace only with the same type of battery. Do not disassemble it or attempt to recharge it outside the system. Do not crush, puncture, dispose of in fire, short the external contacts, or expose to water or other liquids. Dispose of the battery in accordance with local regulations and instructions from your service provider.

CAUTION:

- Lithium Battery Caution: Danger of explosion if battery is incorrectly replaced. Replace only with same or equivalent type. Dispose batteries according to manufacturer's instructions.
- Disposal of a BATTERY into fire or a hot oven, or mechanically crushing or cutting of a BATTERY, that can result in an EXPLOSION
- Leaving a BATTERY in an extremely high temperature surrounding environment that can result in an EXPLOSION or the leakage of flammable liquid or gas.
- A BATTERY subjected to extremely low air pressure that may result in an EXPLOSION or the leakage of flammable liquid or gas.

Mise en garde!

AVERTISSEMENT : Il existe un risque d'explosion si la batterie est mal manipulée ou remplacée de manière incorrecte. Remplacez uniquement par le même type de batterie. Ne le démontez pas et ne tentez pas de le recharger en dehors du système. Ne pas écraser, percer, jeter au feu, court-circuiter les contacts externes ou exposer à l'eau ou à d'autres liquides. Jetez la batterie conformément aux réglementations locales et aux instructions de votre fournisseur de services.

MISE EN GARDE:

- Pile au lithium Attention : Danger d'explosion si la pile n'est pas remplacée correctement. Remplacer uniquement par un type identique ou équivalent. Jetez les piles conformément aux instructions du fabricant.
- L'élimination d'une BATTERIE dans le feu ou dans un four chaud, ou l'écrasement ou le découpage mécanique d'une BATTERIE, pouvant entraîner une EXPLOSION
- Laisser une BATTERIE dans un environnement à température extrêmement élevée pouvant entraîner une EXPLOSION ou une fuite de liquide ou de gaz inflammable.
- UNE BATTERIE soumise à une pression d'air extrêmement basse pouvant entraîner une EXPLOSION ou une fuite de liquide ou de gaz inflammable.

Content

1.	Getting Started	17
1.1	Safety Precautions	17
1.2	Packing List.....	17
1.3	System Specifications	19
1.4	System Overview	24
1.4.1	Front View.....	24
1.4.2	Rear View	24
1.5	System Dimensions	25
1.6	Operating Principle.....	26
2.	Hardware Configuration	27
2.1	NUC-RPU connector mapping	28
2.1.1	Serial Port 1/2 connector (COM1/2)	28
2.2	NUC-RPU Overviews	29
2.3	NUC-RPU Jumper & Connector list	30
2.4	NUC-RPU Jumpers & Connectors settings	31
2.4.1	M.2 Key B power select (JPWR_SEL1)	31
2.4.2	Clear CMOS (JRTC1).....	31
2.4.3	AT/ATX Input power select (JAT1).....	32
2.4.4	ESPI connector (JESPI1)	32
2.4.5	Battery connector (JBAT1)	33
2.4.6	Front Panel connector (JFP1)	33
2.4.7	USB2.0 connector (JUSB1).....	34
2.4.8	SPI connector (JSPI1).....	34
2.4.9	General purpose I/O connector (JDIO1)	35
2.4.10	Power connector (DCIN2)	35
2.4.11	SATA Power connector (JSATAPWR1)	36
2.4.12	EC connector (JEC1).....	36
3.	Installation	37
3.1	Installing Memory card (NUC-RPU)	39
3.2	Installing M.2 Key-M card (NUC-RPU).....	40
3.3	Installing VESA Mounting (NUC-RPU).....	41
3.4	Installing Din Rail Mounting (NUC-RPU).....	42
3.5	Installing Stand Mounting (NUC-RPU).....	43
3.6	System Mounting	44
14	NUC-RPU Quick Reference Guide	

4. Drivers Installation.....	45
4.1 Install Chipset Driver	46
4.2 Install VGA Driver.....	47
4.3 Install Ethernet Driver.....	48
4.4 Install ME Driver.....	49
4.5 Install Serial IO Driver	50
5. BIOS Setup	51
5.1 Introduction	52
5.2 Starting Setup	52
5.3 Using Setup	53
5.4 Getting Help	54
5.5 In Case of Problems.....	54
5.6 BIOS setup.....	55
5.6.1 Main Menu	55
5.6.1.1 System Language.....	56
5.6.1.2 System Date	56
5.6.1.3 System Time.....	56
5.6.2 Advanced Menu.....	56
5.6.2.1 Connectivity Configuration.....	57
5.6.2.2 CPU Configuration.....	58
5.6.2.2.1 Efficient-core Information.....	59
5.6.2.2.2 Performance-core Information.....	59
5.6.2.3 Power & Performance	60
5.6.2.3.1 CPU – Power Management Control	60
5.6.2.4 PCH-FW Configuration	61
5.6.2.4.1 Firmware Update Configuration.....	62
5.6.2.4.2 PTT Configuration.....	62
5.6.2.5 Trusted Computing	63
5.6.2.6 APCI Settings	63
5.6.2.7 Super IO Configuration	64
5.6.2.7.1 Serial Port 1 Configuration	64
5.6.2.7.2 Serial Port 2 Configuration	65
5.6.2.8 EC 5782 HW Monitor.....	66
5.6.2.9 S5 RTC Wake Settings.....	66
5.6.2.10 Serial Port Console Redirection	67
5.6.2.10.1 Legacy Console Redirection Settings	67
5.6.2.11 USB Configuration.....	68
5.6.2.12 Network Stack Configuration	69
5.6.2.13 NVMe Configuration	69
5.6.3 Chipset.....	70

NUC-RPU

5.6.3.1	System Agent (SA) Configuration.....	70
5.6.3.1.1	Memory Configuration	71
5.6.3.1.2	Graphics Configuration	71
5.6.3.2	PCH-IO Configuration.....	72
5.6.3.2.1	PCI Express Configuration	72
5.6.3.2.1.1	PCI Express Root Port 5(M.2 KeyE).....	73
5.6.3.2.1.2	PCI Express Root Port 6(USB HUB)	74
5.6.3.2.1.3	PCI Express Root Port 8(LAN2-I225/I226).....	75
5.6.3.2.1.4	PCI Express Root Port 12(M.2 KeyB).....	76
5.6.3.2.2	SATA Configuration	77
5.6.3.2.3	HD Audio Configuration	78
5.6.3.3	Board & Panel Configuration	78
5.6.3.3.1	SHOW DMI INFO	79
5.6.4	Security	80
5.6.4.1	Secure Boot	80
5.6.5	Boot.....	81
5.6.6	Save and Exit.....	82
5.6.6.1	Save Changes and Reset.....	82
5.6.6.2	Discard Changes and Reset.....	82
5.6.6.3	Restore Defaults	83
5.6.6.4	Launch EFI Shell from filesystem device	83
5.6.7	MEBx	83
6.	Maintenance & Troubleshooting.....	84
7.	Product Application	89
8.	Operating the Device	90

1. Getting Started

1.1 Safety Precautions

Warning!



Always completely disconnect the power cord from your chassis whenever you work with the hardware. Do not make connections while the power is on. Sensitive electronic components can be damaged by sudden power surges. Only experienced electronics personnel should open the PC chassis.

Caution!



Always ground yourself to remove any static charge before touching the CPU card. Modern electronic devices are very sensitive to static electric charges. As a safety precaution, use a grounding wrist strap at all times. Place all electronic components in a static-dissipative surface or static-shielded bag when they are not in the chassis.

1.2 Packing List

Before installation, please ensure all the items listed in the following table are included in the package.

Item	Description	Q'ty
1	NUC-RPU	1
2	Adapter	1
3	Table Stand, VESA, DIN Rail Kit	1
4	Screw Kit (M.2, Mount kit)	1
5	Rubber Foot	4



If any of the above items is damaged or missing, contact your retailer.

Unpacking

Note:

If any of the components listed in the checklist below are missing, do not proceed with the installation. Contact the Avalue reseller or vendor the product was purchased from or contact an Avalue sales representative directly by sending an email to sales@avalue.com.

To unpack the flat bezel panel PC, follow the steps below.

WARNING!

The front side LCD screen has a protective plastic cover stuck to the screen. Only remove the plastic cover after the fiat bezel panel PC has been properly installed. This ensures the screen is protected during the installation process.

Step 1: Carefully cut the tape sealing the box. Only cut deep enough to break the tape.

Step 2: Open the outside box.

Step 3: Carefully cut the tape sealing the box. Only cut deep enough to break the tape.

Step 4: Open the inside box.

Step 5: Lift the panel PC out of the boxes.

Step 6: Remove the peripheral parts box from the main box.

1.3 System Specifications

System Information	
Processor	Emb Intel® Core™ i7-1365UE Processor (10-Core, 2P+8E, 96EU, 12M, vPro, 15W) Intel® Core™ i5-1345UE Processor (10-Core, 2P+8E, 80EU, 12M, vPro, 15W) Intel® Core™ i5-1335UE Processor (10-Core, 2P+8E, 80EU, 12M, Non-vPro, 15W) Intel® Core™ i3-1315UE Processor (6-Core, 2P+4E, 64EU, 10M, Non-Vpro, 15W) Non-Emb Intel® Core™ i7-1355U Processor (10-Core, 2P+8E, 96EU, 12M, vPro, 15W) Intel® Core™ i5-1335U Processor (10-Core, 2P+8E, 80EU, 12M, vPro, 15W) Intel® Core™ i3-1315U Processor (6-Core, 2P+4E, 64EU, 10M, Non-Vpro, 15W)
System Memory	1-262-Pin SO-DIMM Socket (Capacity Max. Up to 32GB DDR5 5200)
I/O Chipset	EC-ITE: IT5782VG The same to ECM-RPL
BIOS Information	AMI uEFI BIOS, 256Mbit SPI Flash ROM
Watchdog Timer	H/W Reset, 1sec. ~ 65535sec and 1sec. or 1min./step
H/W Status Monitor	Monitoring CPU Temperature, Voltage with Auto Throttling Control
TPM	dTPM 2.0 (Infineon SLB9670VQ2.0 (E14S4967000H) as the default) Co-layout NuvoTon NPCT754AADYX (E14S4075401H)
iAMT	i7-1365UE & i5-1345UE
SBC	NUC-RPU
Expansion	
M.2 (Key-X, Size, Signal)	1-M.2 Key-E 2230 (PCIe, USB 2.0, CNVi) 1-M.2 Key-B 2242/3042/3052 with internal SIM slot (PCIe, SATA, USB 3.0, USB 2.0) 1-M.2 Key-M 2280 (PCIe4x4)
Storage	
M.2 (Key-X, Size, Signal)	1-M.2 Key-M 2280 NVMe (PCIe Gen4x4) 1-M.2 Key-B 2242 SSD (SATA Gen3)
Edge I/O (Front)	
USB Port	2-USB 2.0
COM Port	2-RS-232/422/485 (Control by BIOS setting)
Audio	1-Mic-In 1-Line-Out
Power Button	1-PWR BTN with LED

NUC-RPU

LED Indicator	1-Data Access LED flash while any M.2 Key-B SATA or Key-M NVM storage data transfer in progress.
	1-WWAN LED will light when module is installed. LED flash while data transfer in progress.
	1-WLAN LED will light when module is installed. LED flash while data transfer in progress.
	* The LED definition will be based on the module if the LED is controlled by the module setting.
Edge I/O (Rear)	
USB Port	4-USB 3.2 Gen 2x1 2-USB 3.2 Gen1 (E14S4020100H Controller for PCIE to 4 port USB3.2 GEN1)
HDMI	4-HDMI 2.0b
DC Connector	1-Lockable DC Jack
Kensington Lock	1-Kensington Lock
Edge I/O (Right)	
Antenna	2-Covered antenna hole
Edge I/O (Left)	
Antenna	2-Covered antenna hole
MIO	
GPIO	1-2x6P 2.0mm hear for 8-bit GPIO, SMBUS, +5V, GND
SATA Signal	1-SATA signal
SATA PWR	1-2P 2.0mm wafer
USB 2.0	1-2x5P 2.0mm header (2-USB 2.0)
AT/ATX Selector	1-3P 2.0mm header (AT/ATX)
RTC Battery	1-2P 1.25mm wafer reserved for the wired RTC battery
Clear CMOS	1-3P 2.0mm header
eSPI	1-2-6P 1.25mm header
EC Debug	1-3P 2.0mm header
Front Panel	1-2x5P 2.0mm header
BIOS SPI	1-2x4P 2.0mm header
DC-Input	1-6P 2.54mm wafer
Display	

Graphic Chipset	Intel® Iris® Xe Graphics eligible Intel® UHD Graphics for 13th Gen Intel® Processors																																																
Resolution	HDMI 2.0 4096x2304@60Hz 4 Independent Displays (up to 4K) Support max 4 independent displays. Able to set 2x2 collage mode natively using all 4 display pipes Lock display is supported and is persistent even after a reboot																																																
Audio																																																	
Audio Codec	RealTek ALC888S-VD2-GR co-layout RealTek ALC897-VA-CG																																																
Ethernet																																																	
LAN Chipset	Intel® Ethernet Connection I219-LM Intel® Ethernet Controller I226-V																																																
Specification	10/100/1000 GbE (I219-LM) 10/100/1000/2.5 GbE (I226-V)																																																
LED Indicator	<table border="1"> <thead> <tr> <th colspan="4">Max. 1G LAN Port</th> </tr> <tr> <th colspan="2">ACT/LINK</th> <th colspan="2">SPEED</th> </tr> <tr> <th>LED</th> <th>Definition</th> <th>LED</th> <th>Definition</th> </tr> </thead> <tbody> <tr> <td>Light Off</td> <td>No Link</td> <td>Solid Orange</td> <td>1G</td> </tr> <tr> <td>Solid Yellow</td> <td>Connection</td> <td>Solid Green</td> <td>100M</td> </tr> <tr> <td>Yellow Flashing</td> <td>Activity</td> <td>Light Off</td> <td>10M</td> </tr> <tr> <th colspan="4">Max. 2.5G LAN Port</th> </tr> <tr> <th colspan="2">ACT/LINK</th> <th>SPEED</th> <th></th> </tr> <tr> <th></th> <th>Definition</th> <th>LED</th> <th>Definition</th> </tr> <tr> <td>Light Off</td> <td>No Link</td> <td>Solid Orange</td> <td>2.5G</td> </tr> <tr> <td>Solid Yellow</td> <td>Connection</td> <td>Solid Green</td> <td>1G/100M</td> </tr> <tr> <td>Yellow Flashing</td> <td>Activity</td> <td>Light Off</td> <td>10M</td> </tr> </tbody> </table>	Max. 1G LAN Port				ACT/LINK		SPEED		LED	Definition	LED	Definition	Light Off	No Link	Solid Orange	1G	Solid Yellow	Connection	Solid Green	100M	Yellow Flashing	Activity	Light Off	10M	Max. 2.5G LAN Port				ACT/LINK		SPEED			Definition	LED	Definition	Light Off	No Link	Solid Orange	2.5G	Solid Yellow	Connection	Solid Green	1G/100M	Yellow Flashing	Activity	Light Off	10M
Max. 1G LAN Port																																																	
ACT/LINK		SPEED																																															
LED	Definition	LED	Definition																																														
Light Off	No Link	Solid Orange	1G																																														
Solid Yellow	Connection	Solid Green	100M																																														
Yellow Flashing	Activity	Light Off	10M																																														
Max. 2.5G LAN Port																																																	
ACT/LINK		SPEED																																															
	Definition	LED	Definition																																														
Light Off	No Link	Solid Orange	2.5G																																														
Solid Yellow	Connection	Solid Green	1G/100M																																														
Yellow Flashing	Activity	Light Off	10M																																														
Power Requirement																																																	
DC Input	+12V (±5% only for DQV testing)																																																
DC Input Connector	Lockable DC Jack																																																
ACPI	Single power ATX support S0, S3, S4, S5																																																
Power Mode	AT/ATX (ATX is default setting)																																																
Adapter	AC to DC adapter																																																
Mechanical & Environment																																																	
Operating Temp.	0°C ~ 50°C (32°F ~ 122°F) with 0.5m/s air flow																																																
Storage Temp.	-30~70C° (-22°F ~ 158°F)																																																

NUC-RPU

Operating Humidity	40°C @ 95% Relative Humidity, Non-condensing
Dimension (W*L*H)	174mm x 125mm x 39mm(6.85" x 4.92" x 1.53")
Weight	0.85kg
Vibration Test	<p>Random Vibration Operation</p> <ol style="list-style-type: none"> 1 Test PSD : 0.00454G²/Hz , 1.5 Grms 2 System condition : operation mode 3 Test frequency : 5~500 Hz 4 Test axis : X,Y and Z axis 5 Test time : 30 minutes per each axis 6 IEC60068-2-64 Test Fh 6 Storage : SSD <p>Sine Vibration test (Non-operation)</p> <ol style="list-style-type: none"> 1 Test Acceleration : 2G 2 Test frequency : 5~500 Hz 3 Sweep : 1 Oct/ per one minute. (logarithmic) 4 Test Axis : X,Y and Z axis 5 Test time :30 min. each axis 6 System condition : Non-Operating mode 7. Reference IEC 60068-2-6 Testing procedures <p>Package Vibration Test:</p> <ol style="list-style-type: none"> 1 Test PSD : 0.026G²/Hz , 2.16 Grms 2 Test frequency : 5~500 Hz 3 Test axis : X,Y and Z axis 4 Test time : 30 minutes per each axis 5 IEC 60068-2-64 Test Fh
Shock Test	<ol style="list-style-type: none"> 1 Wave from : Half Sine wave 2 Acceleration Rate : 55G 3 Duration Time : 11ms 4 No. of shock : 3 times 5 Test Axis : +/- X, +/-Y, +/-Z axis 6 operation mode 7 Reference IEC 60068-2-27 testing procedures <p>Test Eb : SSD Shock Test</p>
Drop Test	<p>Package drop test</p> <p>Reference ISTA 2A, Method : IEC-60068-2-32 Test:Ed</p> <p>Test Ea : Drop Test</p>

	1 Test phase : One corner, three edges, six faces 2 Test high : 96.5cm 3 Package weight : 5Kg 4 Test drawing
IP Rating	IP40
Mounting Kit	Table Stand/Din Rail/VESA
Kensington Lock	Kensington Lock
Software Support	
OS Information	Win10, Win11, Linux



Note: Specifications are subject to change without notice.

1.4 System Overview

1.4.1 Front View

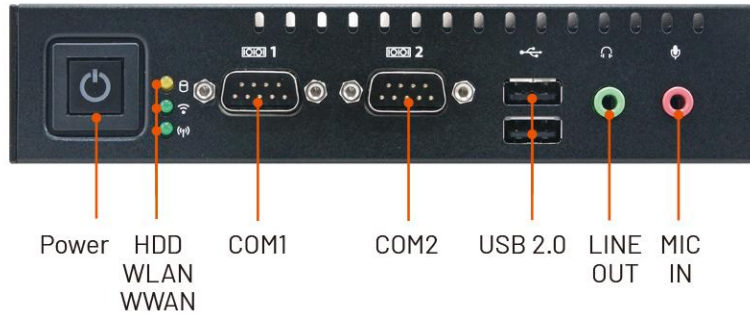

1.4.2 Rear View

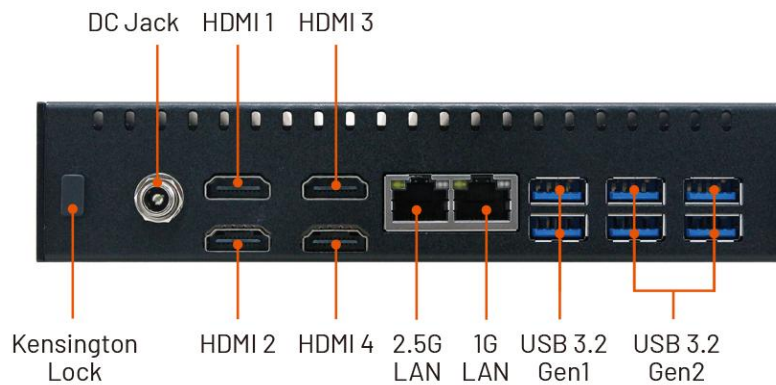

Connectors

Label	Function	Note
Power	Power on button	
HDD	HDD indicator	
WWAN	WWAN Indicator	
WLAN	WLAN Indicator	
COM1/2	Serial Port 1/2 connector	
USB2.0	USB 2.0 connector x 2	
MIC IN	Mic-in audio jack	
LINE OUT	Line-out audio jack	
Kensington Lock	Kensington Lock	
DC Jack	Lockable DC Jack <i>*Note 1</i>	
HDMI1~4	HDMI connector x 4	
LAN	RJ-45 Ethernet x 2	
USB 3.2 Gen1	USB 3.2 Gen1 connector x 2	
USB 3.2 Gen2	USB 3.2 Gen2 connector x 4	

**Note 1:* Do not unplug the adapter and Jack arbitrarily after booting. It will cause system abnormalities.

1.5 System Dimensions

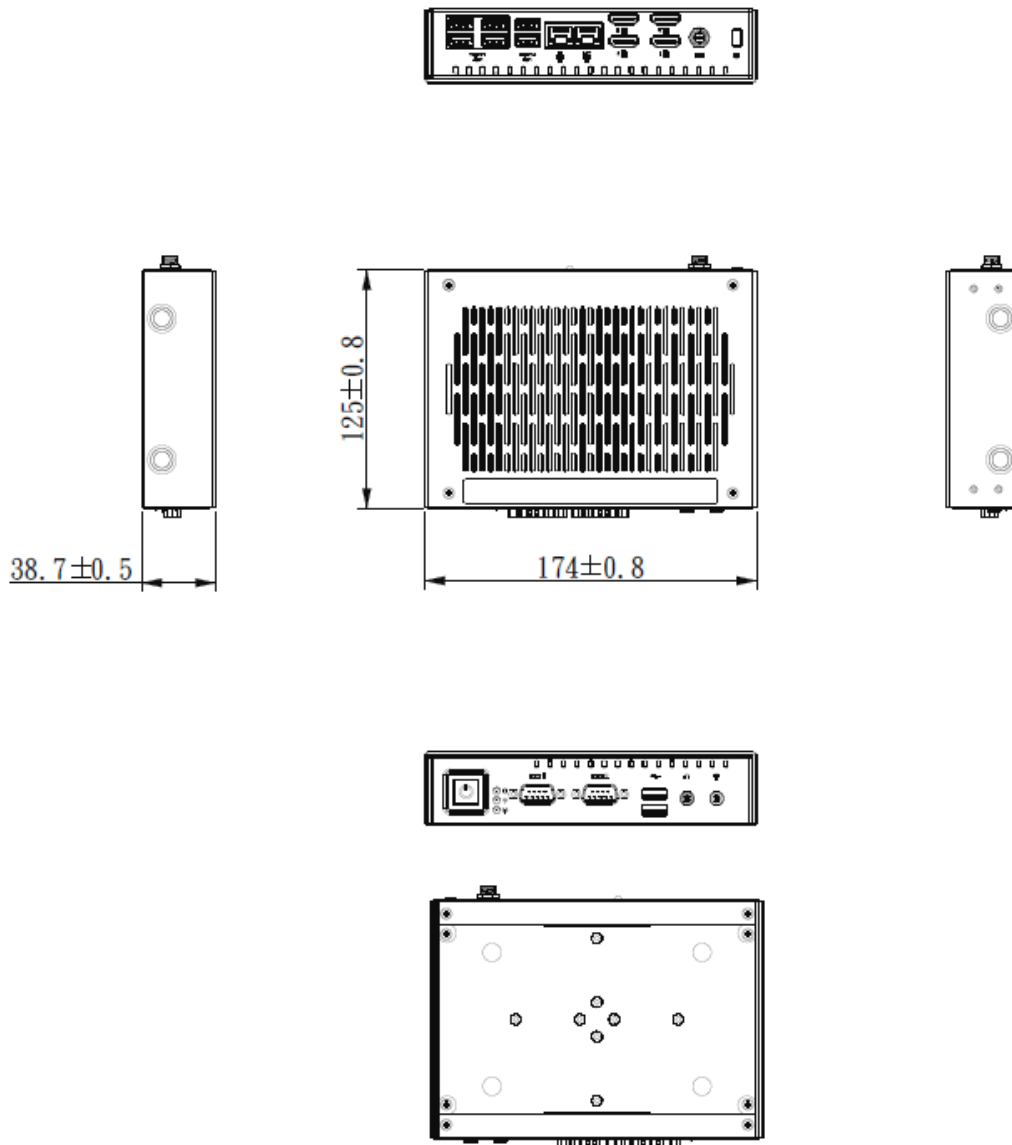

(Unit: mm)

1.6 Operating Principle

(a) Installation:

- Take the device and accessories from package and put in the suitable place.
- Check the packing list (accessories).
- Connect the power cord to the device.
- Put the plug of power cord into receptacle of power source.
- Press power button "Power Icon" on the device to start the device.

(b) Installation for monitor:

- Plug in the monitor cable (HDMI or DP).

(c) Installation keyboard and mouse.

- Plug in mouse and keyboard.

(d) Operation for Turn ON the system

- Turn ON the system.
- Press the power ON/OFF icon firmly to turn power ON/OFF.
- The power ON/OFF LED will turn blue to indicate power is on. **Note*
- Check with the Icon behavior for power status.

**Note*: Power LED.

S0: On

S3: Blinking

S4/S5: Off

BIOS P.O.S.T: Blinking.

2. Hardware Configuration

For advanced information, please refer to:

- 1- NUC-RPU included in this manual.



Note: If you need more information, please visit our website:

www.avalue.com

2.1 NUC-RPU connector mapping

2.1.1 Serial Port 1/2 connector (COM1/2)

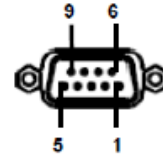
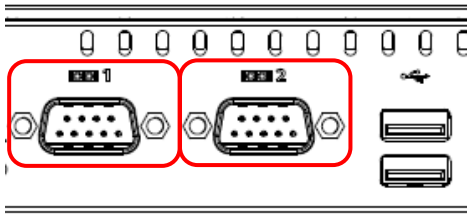

In RS-232 Mode

Signal	PIN	PIN	Signal
NDCD#	1	6	NDSR#
NRXD	2	7	NRTS#
NTXD	3	8	NCTS#
NDTR#	4	9	NRI#
GND	5		

In RS-422 Mode

Signal	PIN	PIN	Signal
TxD1-	1	6	NC
TxD1+	2	7	NC
RxD1+	3	8	NC
RxD1-	4	9	NC
GND	5		

In RS-485 Mode

Signal	PIN	PIN	Signal
DATA1-	1	6	NC
DATA1+	2	7	NC
NC	3	8	NC
NC	4	9	NC
GND	5		

2.2 NUC-RPU Overviews

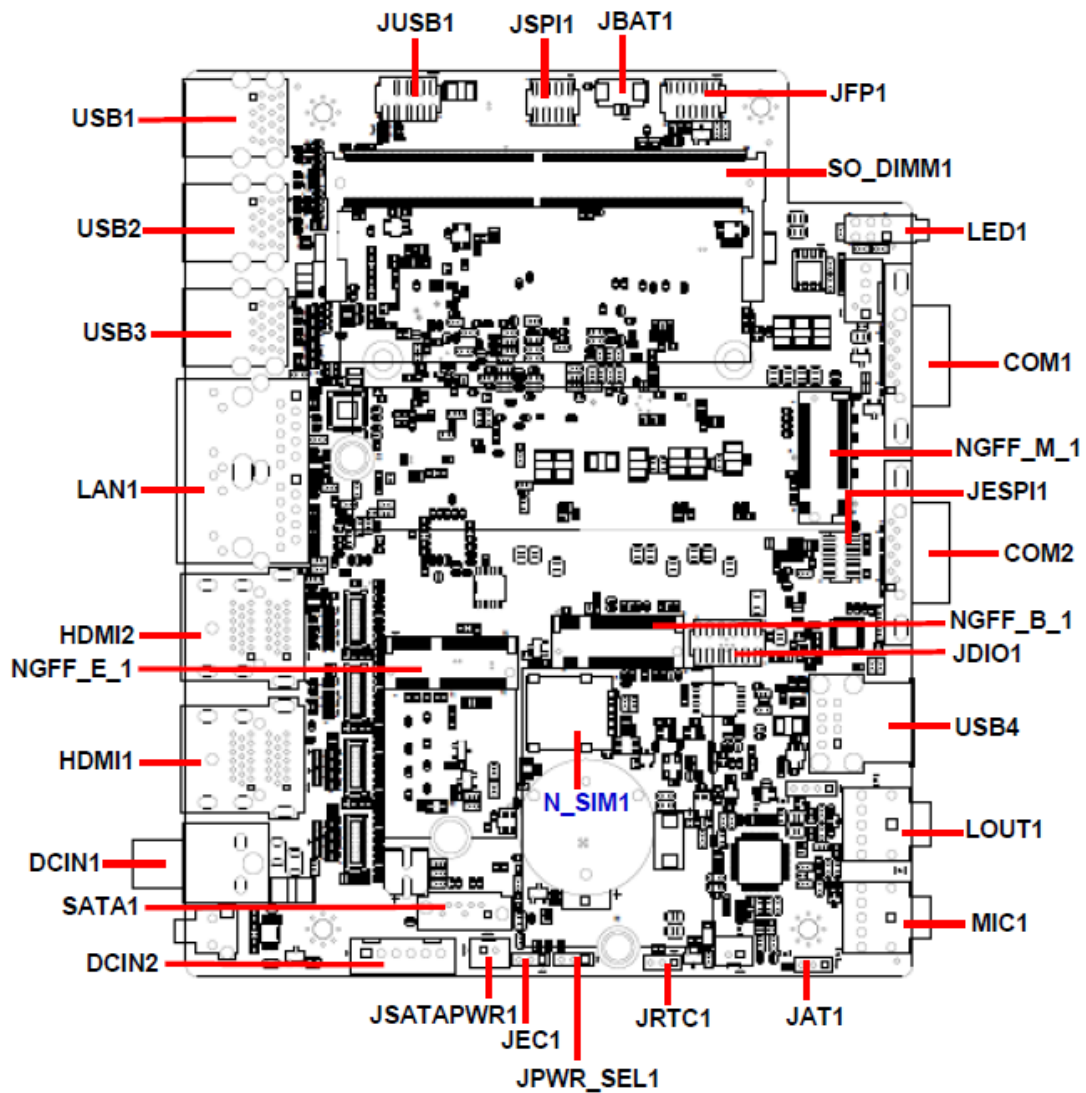

2.3 NUC-RPU Jumper & Connector list

Jumpers

Label	Function	Note
JPWR_SEL1	M.2 Key B power select	3 x 1 header, pitch 2.00mm
JAT1	AT/ATX Input power select	3 x 1 header, pitch 2.00mm
JRTC1	Clear CMOS	3 x 1 header, pitch 2.00mm

Connectors

Label	Function	Note
COM1/2	Serial port 1/2 connector	
JDIO1	General purpose I/O connector	6 x 2 header, pitch 2.00mm
NGFF_B_1	M.2 KEY-B 3052 connector	
NGFF_M_1	M.2 KEY-M 2280 connector	
NGFF_E_1	M.2 KEY-E 2230 connector	
LED1	HDD/Power LED indicator	
JFP1	Front Panel connector	5 x 2 header, pitch 2.00mm
USB1/2	4 x USB3.2 Gen2 connector	
USB3	2 x USB3.2 Gen1 connector	
USB4	2 x USB2.0 connector	
JUSB1	USB2.0 connector	5 x 2 header, pitch 2.00mm
LAN1	RJ-45 Ethernet 1/2	
JBAT1	Battery connector	2 x 1 wafer, pitch 1.25mm
JSPI1	SPI connector	4 x 2 header, pitch 2.00mm
DCIN1	Power connector	
DCIN2	Power connector	6 x 1 wafer, pitch 2.50mm
SO_DIMM1	DDR5 SODIMM socket	
JESPI1	ESPI connector	6 x 2 header, pitch 1.27mm
N_SIM1	SIM card slot	
MIC1	Mic-in audio jack	
LOUT1	Line-out audio jack	
JEC1	EC connector	3 x 1 header, pitch 2.00mm
SATA1	Serial ATA connector	
JSATAPWR1	SATA Power connector	2 x 1 wafer, pitch 2.00mm
HDMI1/2	2 x HDMI connector	

2.4 NUC-RPU Jumpers & Connectors settings

2.4.1 M.2 Key B power select (JPWR_SEL1)

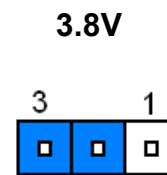
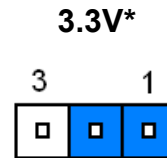
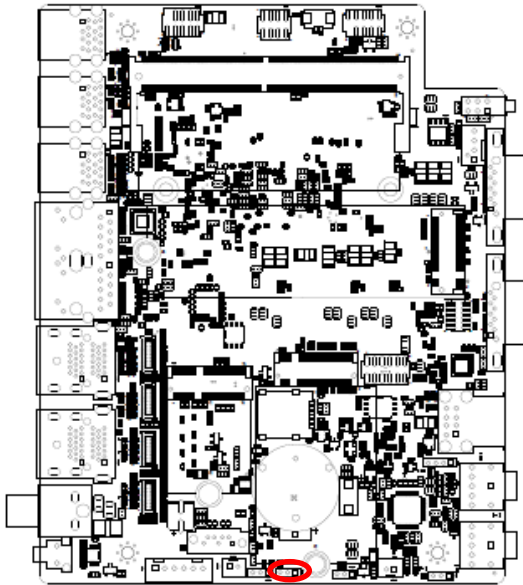

* Default

2.4.2 Clear CMOS (JRRTC1)

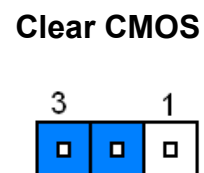
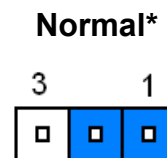
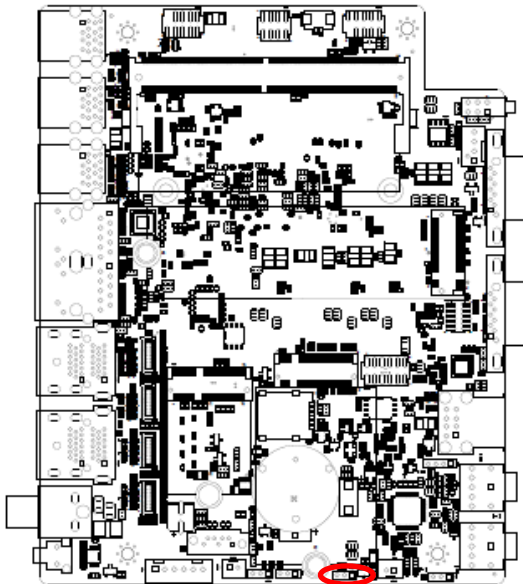

* Default

NUC-RPU

2.4.3 AT/ATX Input power select (JAT1)

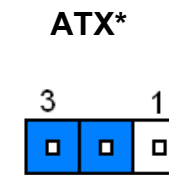
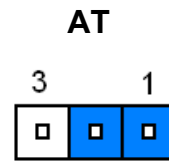
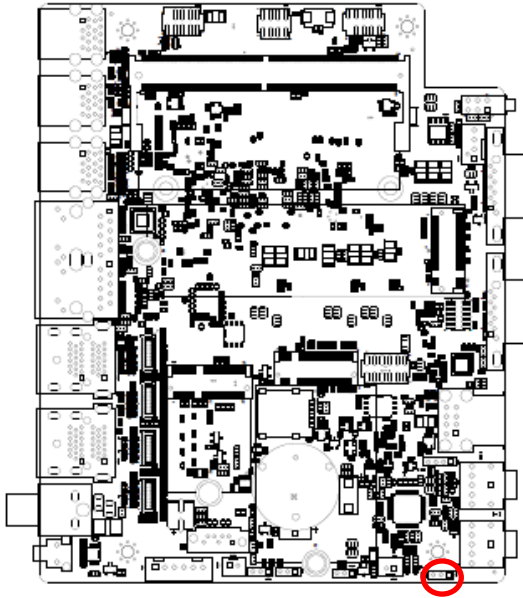

* Default

2.4.4 ESPI connector (JESPI1)

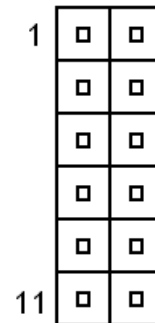
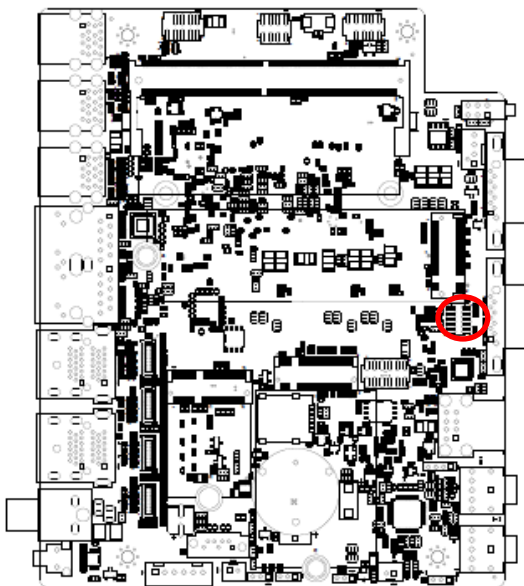

Signal	PIN	PIN	Signal
ESPI_IO0	1	2	+3.3VSB
ESPI_IO1	3	4	PLT_RST_BUF#
ESPI_IO2	5	6	ESPI_CS0#
ESPI_IO3	7	8	ESPI_CLK
NC	9	10	GND
ESPI_RST	11	12	NC

2.4.5 Battery connector (JBAT1)

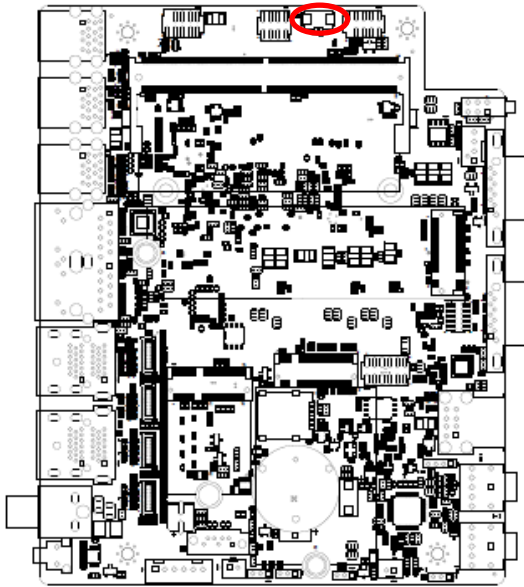

Signal	PIN
+RTCBAT	1
GND	2

2.4.6 Front Panel connector (JFP1)

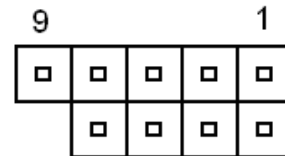
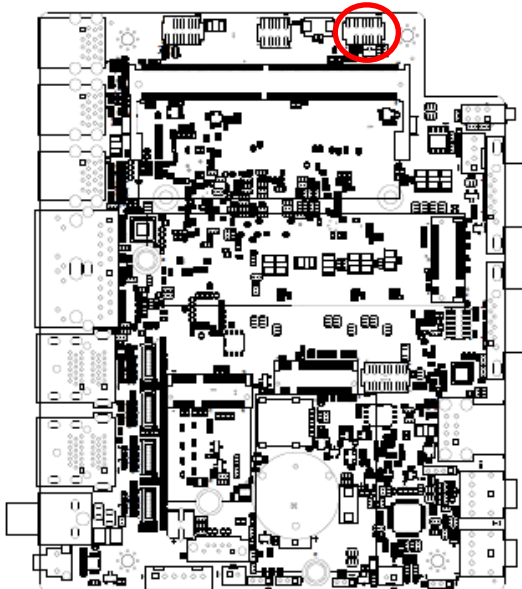

Signal	PIN	PIN	Signal
FP_HDD_LED+	1	2	FP_PWR_LED+
HDD_LED#	3	4	PWR_LED#
RSTBTN#	5	6	PWR_BTN_IN#
GND	7	8	GND
NC	9		

NUC-RPU

2.4.7 USB2.0 connector (JUSB1)

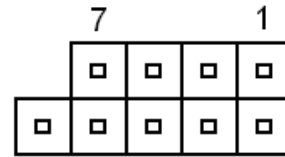
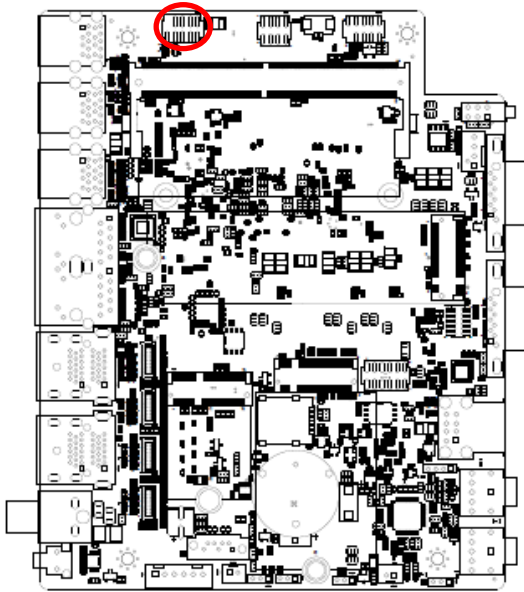

Signal	PIN	PIN	Signal
+V5A_USB_INT	1	2	+V5A_USB_INT
USB_R_DN7	3	4	USB_R_DN8
USB_R_DP7	5	6	USB_R_DP8
GND	7	8	GND
		10	GND

2.4.8 SPI connector (JSPI1)

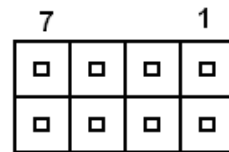
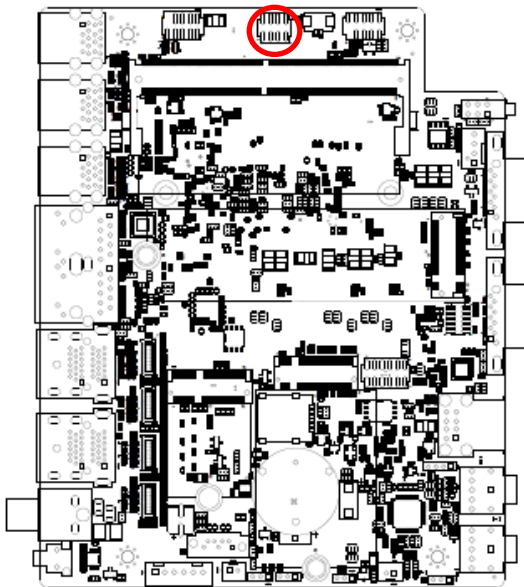

Signal	PIN	PIN	Signal
+V3.3A_SPI	1	2	GND
SPI_CS#0	3	4	SPI_CLK
SPI_MISO	5	6	SPI_MOSI
SPI_HOLD#	7	8	SPI_WP#

2.4.9 General purpose I/O connector (JDIO1)

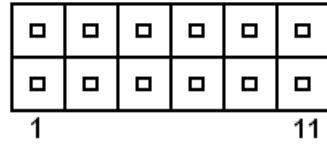
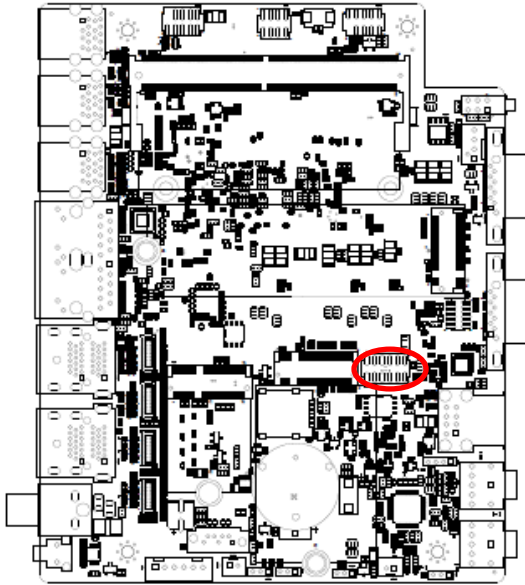

Signal	PIN	PIN	Signal
DIO_GP20	1	2	DIO_GP10
DIO_GP21	3	4	DIO_GP11
DIO_GP22	5	6	DIO_GP12
DIO_GP23	7	8	DIO_GP13
SMB_SCL_S0	9	10	SMB_SDA_S0
GND	11	12	+V5S_DIO

2.4.10 Power connector (DCIN2)

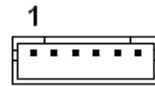
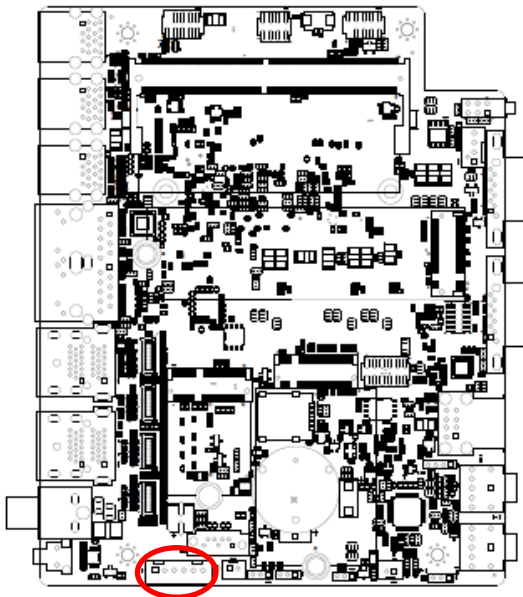

Signal	PIN
+V12A_VIN	1
+V12A_VIN	2
+V12A_VIN	3
GND	4
GND	5
GND	6

NUC-RPU

2.4.11 SATA Power connector (JSATAPWR1)

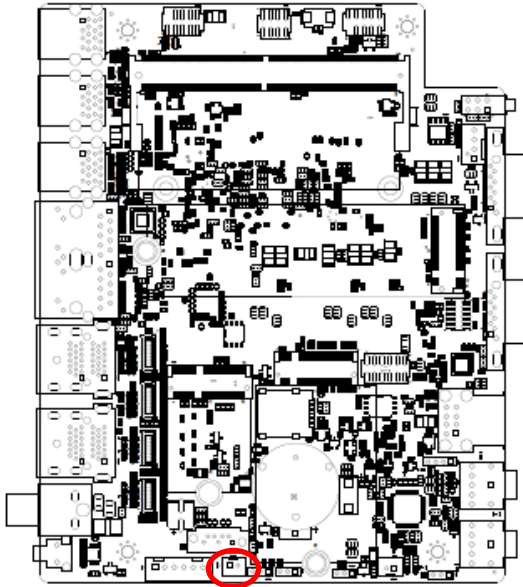

Signal	PIN
GND	1
+5V	2

2.4.12 EC connector (JEC1)

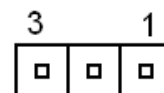
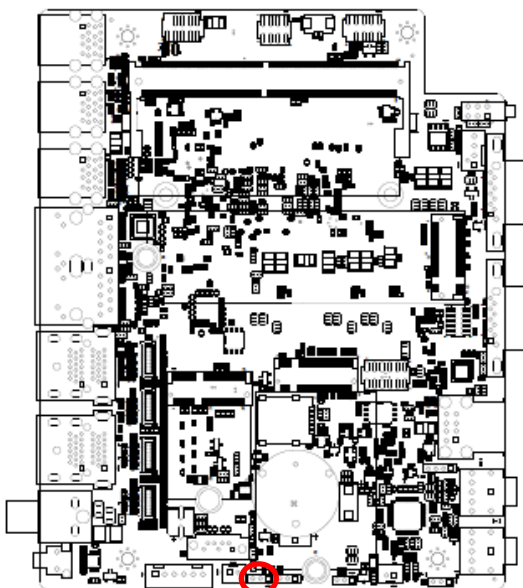

Signal	PIN
EC_SMCLK_DEBUG	1
EC_SMDAT_DEBUG	2
GND	3

3. Installation



Removing the Top Cover Warning

To prevent electric shock or system damage, before removing the chassis cover, must turn off power and disconnect the unit from power source.

Electrostatic discharge (ESD) can cause serious damage to electronic components. Dry climates are especially susceptible to ESD. It is therefore critical that whenever the product is accessed internally, or any other electrical component is handled, the following anti-static precautions are strictly adhered to:

- **Wear an anti-static wristband:** Wearing a simple anti-static wristband can help to prevent ESD from damaging the board.
- **Self-grounding:** Before handling the board, touch any grounded conducting material. During the time the board is handled, frequently touch any conducting materials that are connected to the ground.
- **Use an anti-static pad:** When configuring the product, place it on an anti-static pad. This reduces the possibility of ESD damaging the product.
- **Only handle the edges of the PCB:** When handling the PCB, hold the PCB by the edges.

Installation Precautions

When installing the flat bezel panel PC, please follow the precautions listed below:

- **Power turned off:** When installing the flat bezel panel PC, make sure the power is off. Failing to turn off the power may cause severe injury to the body and/or damage to the system.
- **Certified Engineers:** Never open the equipment. For safety reasons, the equipment should be opened only by qualified skilled person.
- **Anti-static Discharge:** If a user open the rear panel of the flat bezel panel PC, to configure the jumpers or plug in added peripheral devices, ground themselves first and wear an anti-static wristband.

3.1 Installing Memory card (NUC-RPU)

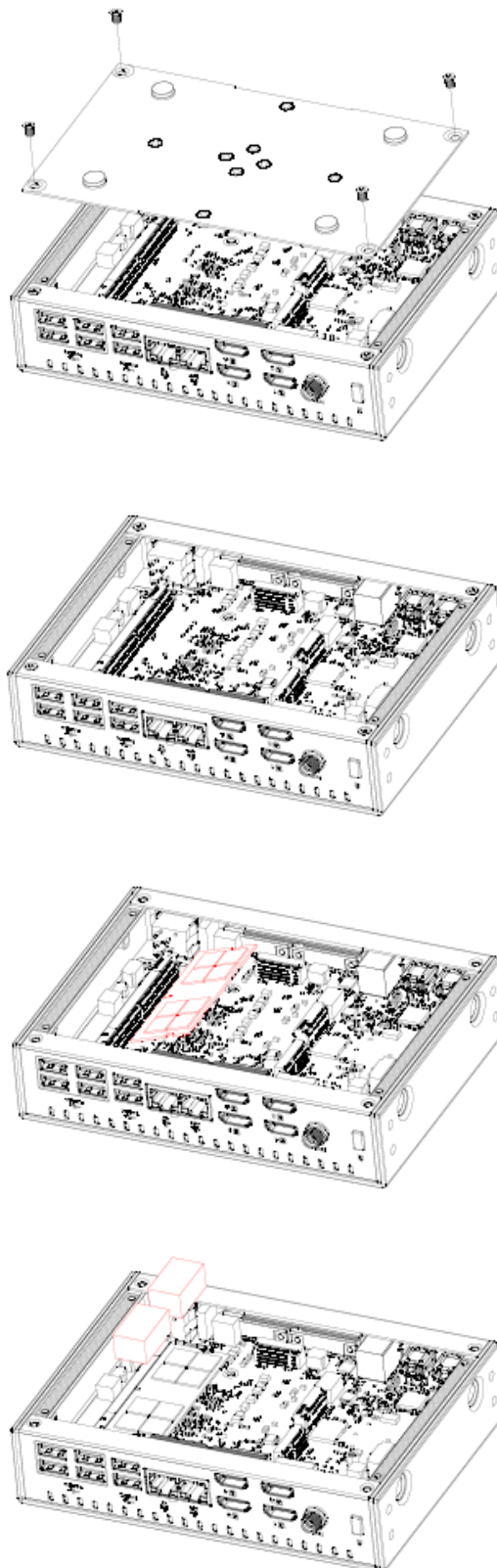

Step1. Remove 4 screws from the bottom of your system and take it off.

Step2. Slide the DDR5 SODIMM into the memory socket and press it down until properly seated.

Step3. Paste the Thermal Pad to complete installation

3.2 Installing M.2 Key-M card (NUC-RPU)

Installing M.2 Key M (2280) card

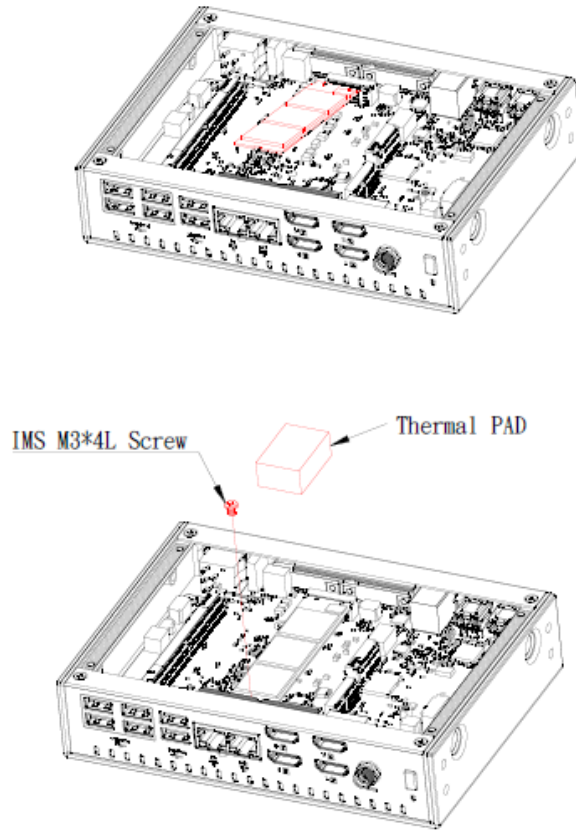

Step1. Insert M.2 Key-M card into designated locations and fasten with the screw to complete installation.

Step2. Paste the Thermal Pad to complete installation

3.3 Installing VESA Mounting (NUC-RPU)

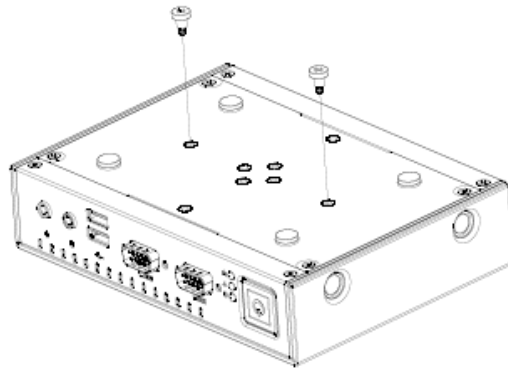

Step1. Insert and fasten two M3*L11.1 screws on the bottom.

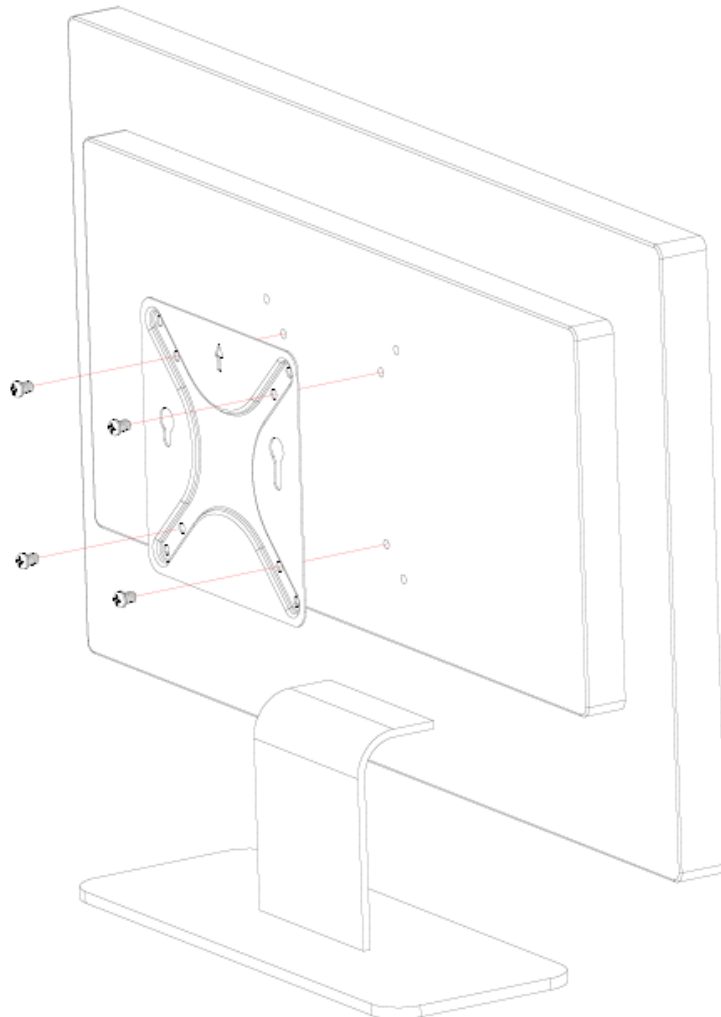

Step2. Fix with four M4*6mm screws on the monitor (or wall).

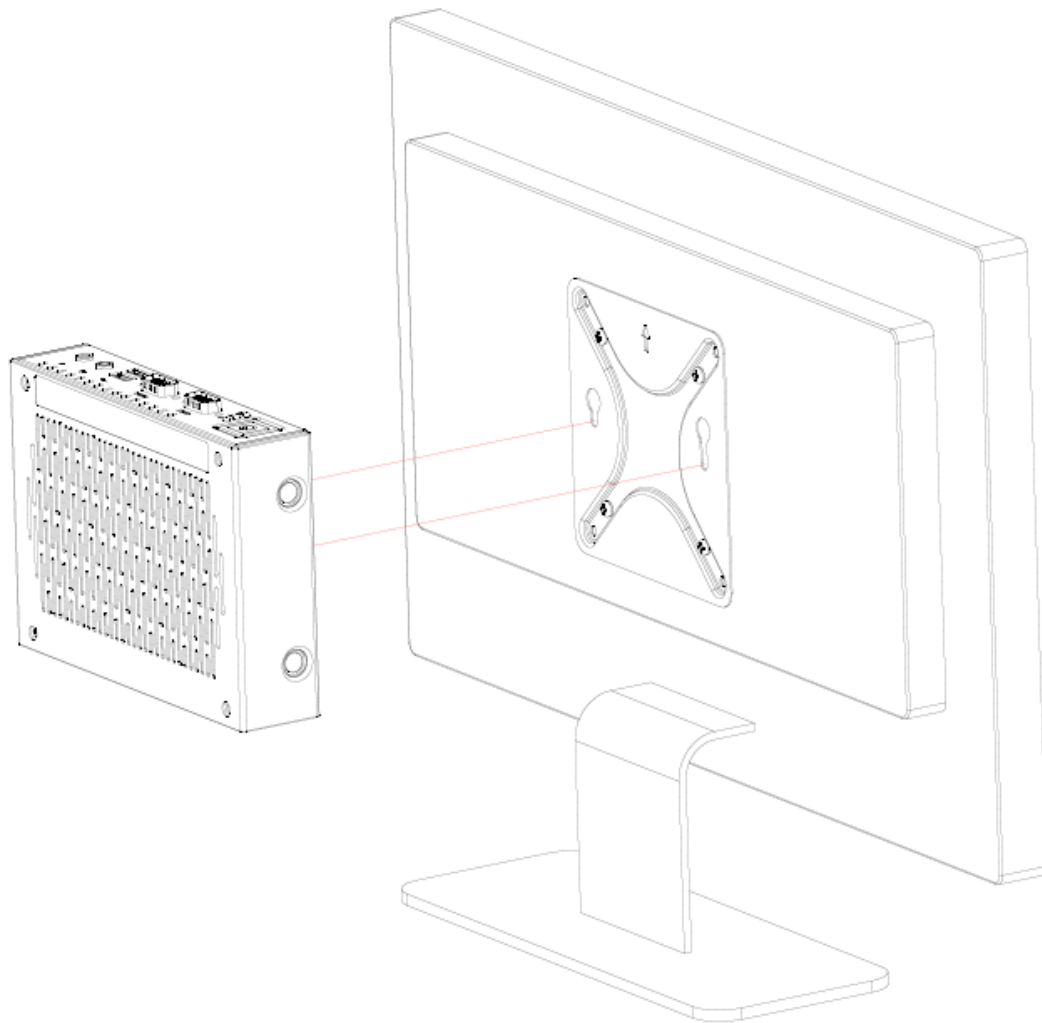

Step3. Slide the system onto the VESA mount bracket.

3.4 Installing Din Rail Mounting (NUC-RPU)

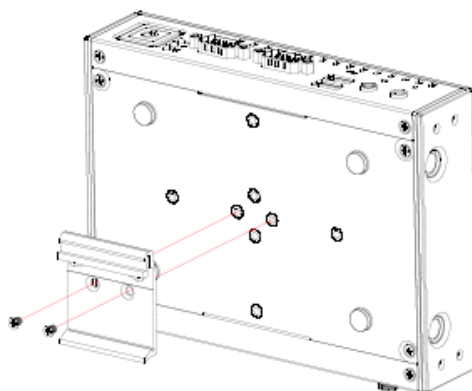

Step1. Insert Din Rail into designated locations and fasten with the two M3*4 screws to complete installation.

3.5 Installing Stand Mounting (NUC-RPU)

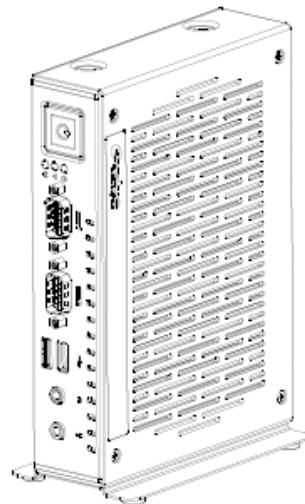
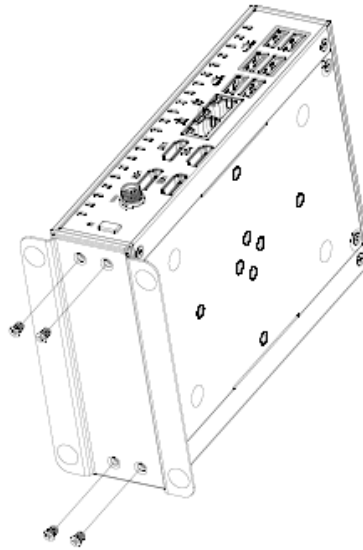

Step1. Fix with four 6#32*5 screws on the system.

3.6 System Mounting

Warning! *More than one person should participate in mounting the panel PC to prevent accidental damage to the panel or personal injury.*



Safety Precautions

Observe the following common safety precautions before installing any electronic device:

- Use separate, non-intersecting paths to route power and networking wires. If power wiring and device wiring paths must be crossed make sure the wires are perpendicular at the intersection point.
- Keep the wires separated according to the interface. Wires that share similar electrical characteristics must be bundled together.
- Do not bundle input wiring with output wiring. Keep them separate.
- When necessary, it is strongly advised that you label wiring to all devices in the system.

4. Drivers Installation

All the drivers are available on Avalue Downloads Area (<https://www.avalue.com/en/support/download>). Type the model name and press Enter to find all the relevant software, utilities, and documentation.

Note:

The panel PC with projected capacitive type touchscreen and Windows 7 (or later) OS does not require touch driver installation. This is because there is a HID touch digitizer built-in driver in Windows 7 or later.

[Chipset ¹](#)
 [Audio ¹](#)
 [Graphics ¹](#)
 [LAN ¹](#)
 [Other ¹](#)

Chipset Total **1** Files

No.	Release Date	Title	Description	Download
01	2023-09-20	Intel Chipset Driver for Win10 x64	Windows 10 64bit	

Audio Total **1** Files

No.	Release Date	Title	Description	Download
01	2023-09-20	Realtek Audio Driver for Win10 x64	Windows 10 64bit	

(For reference only)



Note: Installation procedures and screen shots in this section are for your reference and may not be exactly the same as shown on your screen.

4.1 Install Chipset Driver

All drivers can be found on the Avalue Official Website:
www.avalue.com.



Note: The installation procedures and screen shots in this section are based on Windows 10 operation system. If the warning message appears while the installation process, click Continue to go on.

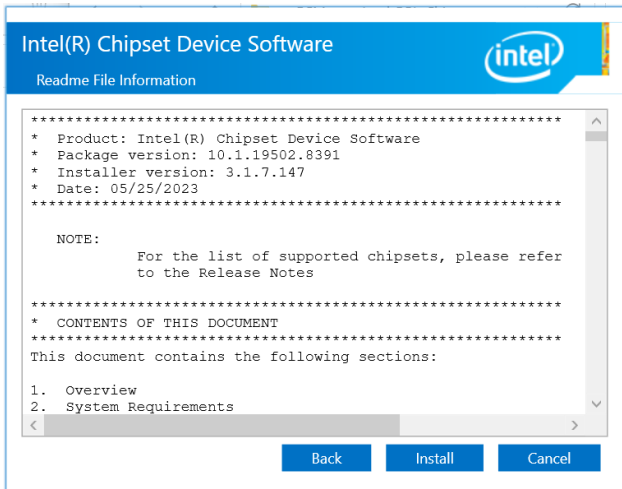

Step 3. Click Install.



Step1. Click Next.

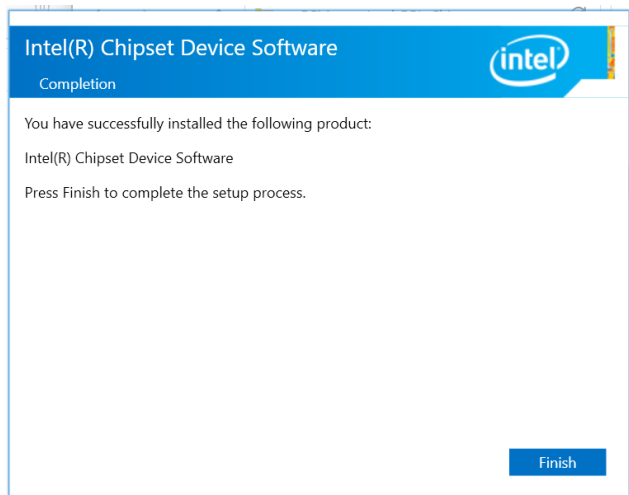

Step 4. Click Finish to complete setup.



Step 2. Click Accept.

4.2 Install VGA Driver

All drivers can be found on the Avalue Official Website:
www.avalu.com.



Note: The installation procedures and screen shots in this section are based on Windows 10 operation system.

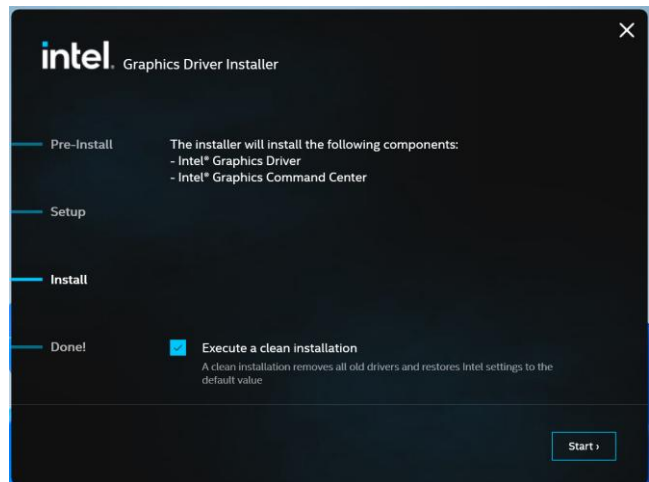

Step 3. Click Start.



Step 1. Click Begin installation.

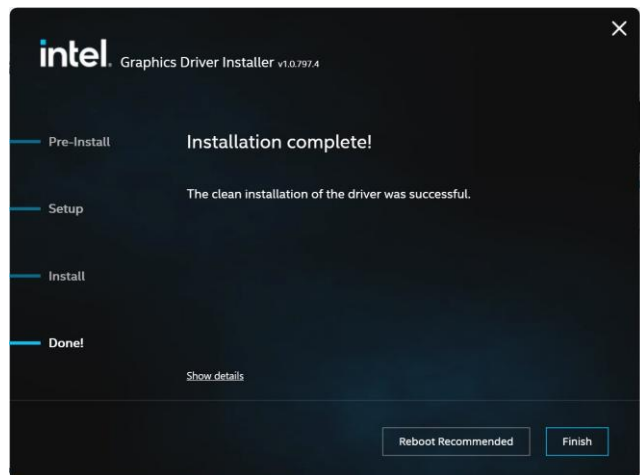

Step 4. Click Finish to complete setup.

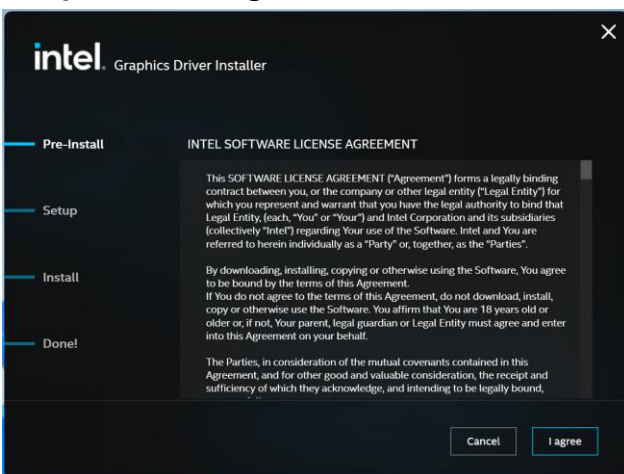

Step 2. Click I agree.

4.3 Install Ethernet Driver

All drivers can be found on the Avalue Official Website:

www.avalue.com.



Note: The installation procedures and screen shots in this section are based on Windows 10 operation system.



Step 1. Click **OK** to continue installation.

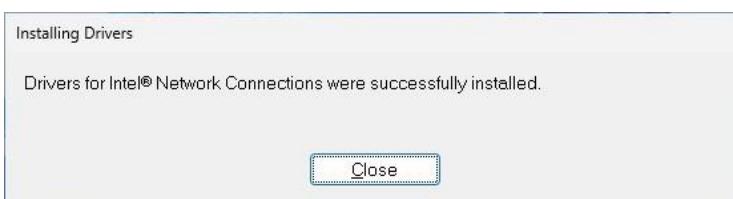

Step 2. Setup completed.

4.4 Install ME Driver

All drivers can be found on the Avalue Official Website:

www.avalue.com.



Note: The installation procedures and screen shots in this section are based on Windows 10 operation system.

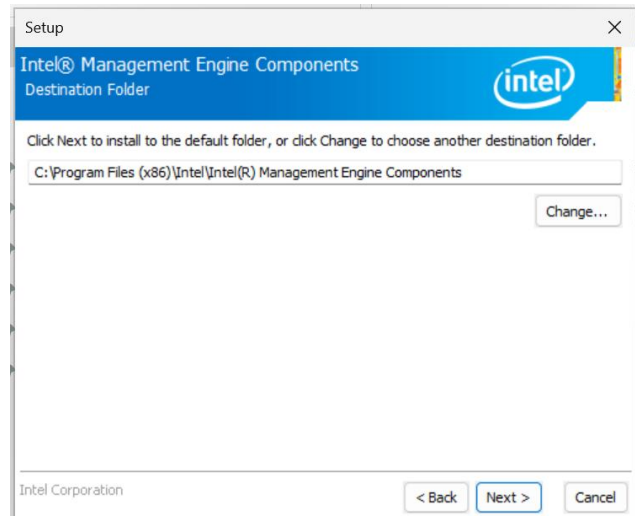

Step 3. Click Next.

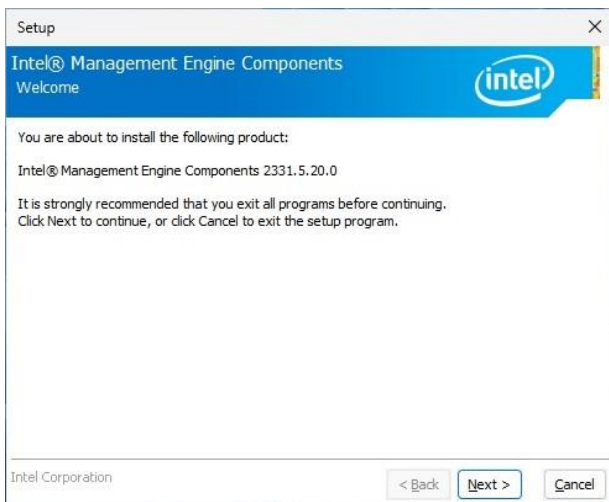

Step 1. Click Next to continue installation.

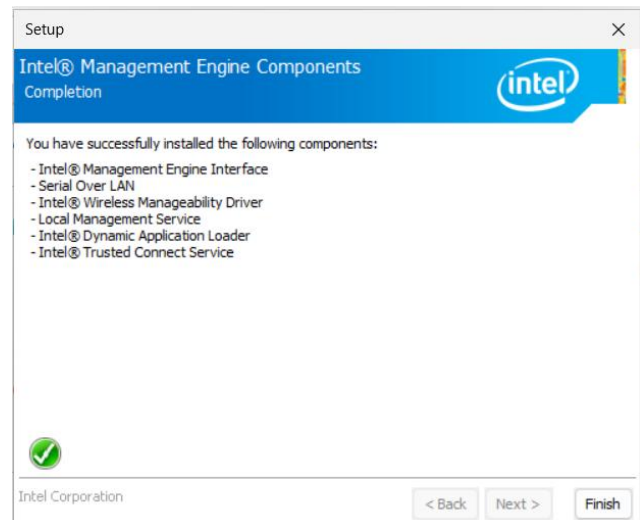

Step 4. Click Finish to complete setup.

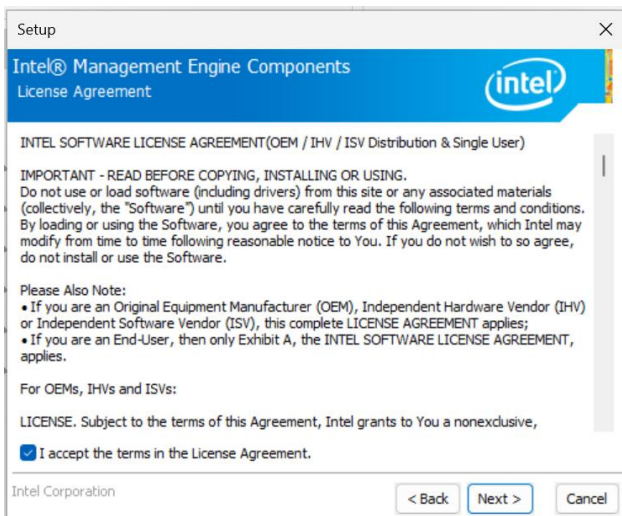

Step 2. Click Next.

4.5 Install Serial IO Driver

All drivers can be found on the Avalue Official Website:

www.avalue.com.



Note: The installation procedures and screen shots in this section are based on Windows 10 operation system.

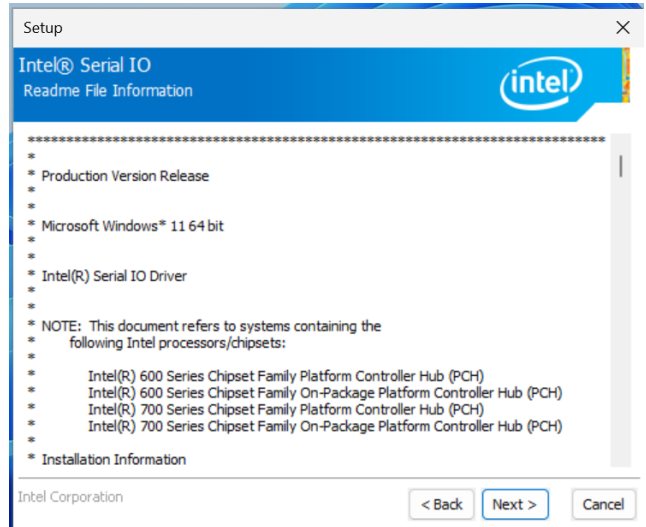

Step 3. Click Next.

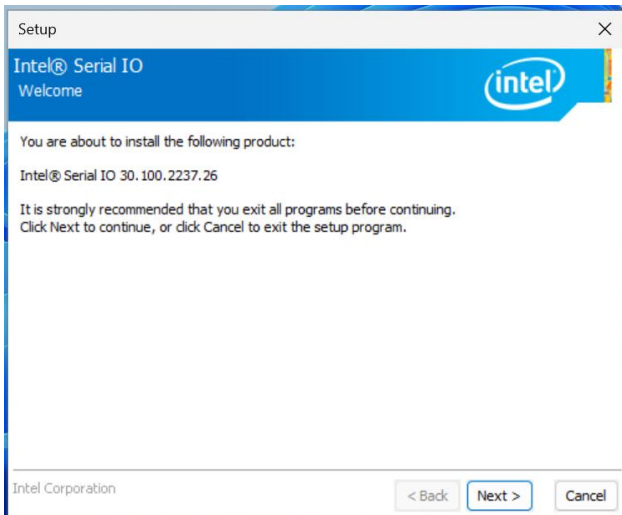

Step 1. Click Next to continue installation.



Step 4. Click Next.

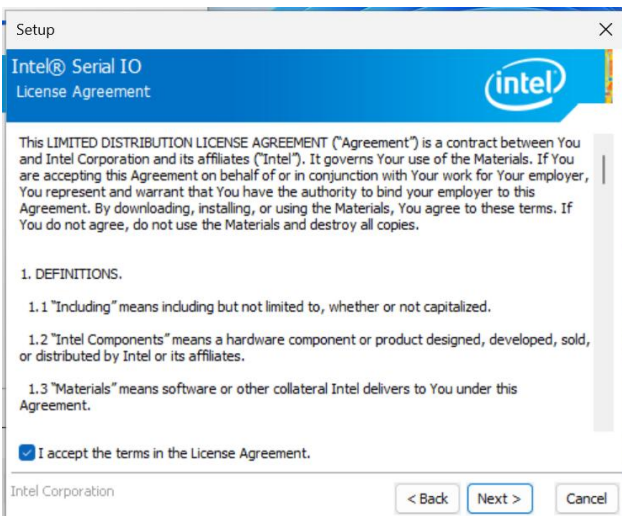

Step 2. Click Next.

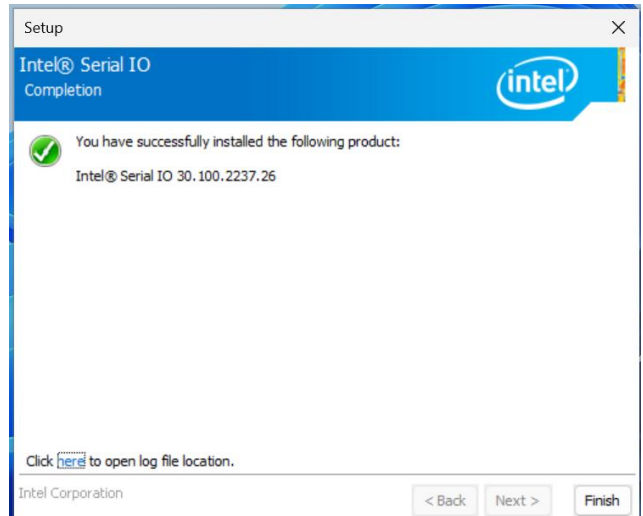

Step 5. Click Finish to complete setup.

5. BIOS Setup

5.1 Introduction

The BIOS setup program allows users to modify the basic system configuration. In this following chapter will describe how to access the BIOS setup program and the configuration options that may be changed.

5.2 Starting Setup

The AMI BIOS™ is immediately activated when you first power on the computer. The BIOS reads the system information contained in the NVRAM and begins the process of checking out the system and configuring it. When it finishes, the BIOS will seek an operating system on one of the disks and then launch and turn control over to the operating system.

While the BIOS is in control, the Setup program can be activated in one of two ways:

By pressing or <F2> immediately after switching the system on, or

By pressing the or <F2> key when the following message appears briefly at the left-top of the screen during the POST (Power On Self Test).

Press or <F2> to enter SETUP

If the message disappears before you respond and you still wish to enter Setup, restart the system to try again by turning it OFF then ON or pressing the "RESET" button on the system case. You may also restart by simultaneously pressing <Ctrl>, <Alt>, and <Delete> keys. If you do not press the keys at the correct time and the system does not boot, an error message will be displayed and you will again be asked to.

Press F1 to Continue, DEL to enter SETUP

5.3 Using Setup

In general, you use the arrow keys to highlight items, press <Enter> to select, use the PageUp and PageDown keys to change entries, press <F1> for help and press <Esc> to quit. The following table provides more detail about how to navigate in the Setup program using the keyboard.

Button	Description
↑	Move to previous item
↓	Move to next item
←	Move to the item in the left hand
→	Move to the item in the right hand
Esc key	Main Menu -- Quit and not save changes into NVRAM Status Page Setup Menu and Option Page Setup Menu -- Exit current page and return to Main Menu
+ key	Increase the numeric value or make changes
- key	Decrease the numeric value or make changes
F1 key	General help, only for Status Page Setup Menu and Option Page Setup Menu
F2 key	Previous Values.
F3 key	Optimized defaults
F4 key	Save & Exit Setup

- **Navigating Through The Menu Bar**

Use the left and right arrow keys to choose the menu you want to be in.



Note: Some of the navigation keys differ from one screen to another.

- **To Display a Sub Menu**

Use the arrow keys to move the cursor to the sub menu you want. Then press <Enter>. A “➤” pointer marks all sub menus.

5.4 Getting Help

Press F1 to pop up a small help window that describes the appropriate keys to use and the possible selections for the highlighted item. To exit the Help Window press <Esc> or the F1 key again.

5.5 In Case of Problems

If, after making and saving system changes with Setup, you discover that your computer no longer is able to boot, the AMI BIOS supports an override to the NVRAM settings which resets your system to its defaults.

The best advice is to only alter settings which you thoroughly understand. To this end, we strongly recommend that you avoid making any changes to the chipset defaults. These defaults have been carefully chosen by both BIOS Vendor and your systems manufacturer to provide the absolute maximum performance and reliability. Even a seemingly small change to the chipset setup has the potential for causing you to use the override.

5.6 BIOS setup

Once you enter the Aptio Setup Utility, the Main Menu will appear on the screen. The Main Menu allows you to select from several setup functions and exit choices. Use the arrow keys to select among the items and press <Enter> to accept and enter the sub-menu.

5.6.1 Main Menu

This section allows you to record some basic hardware configurations in your computer and set the system clock.

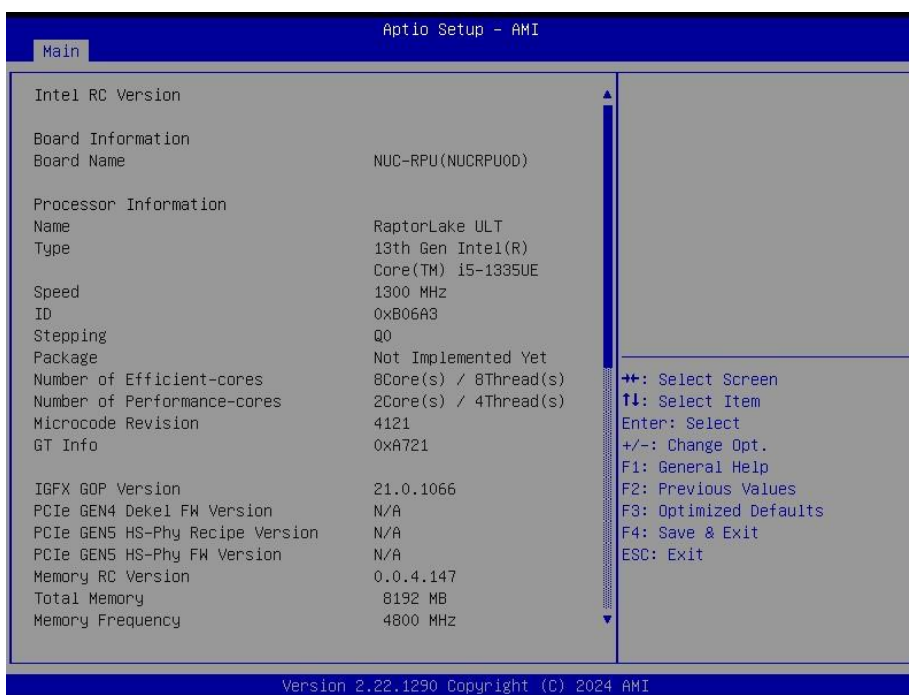
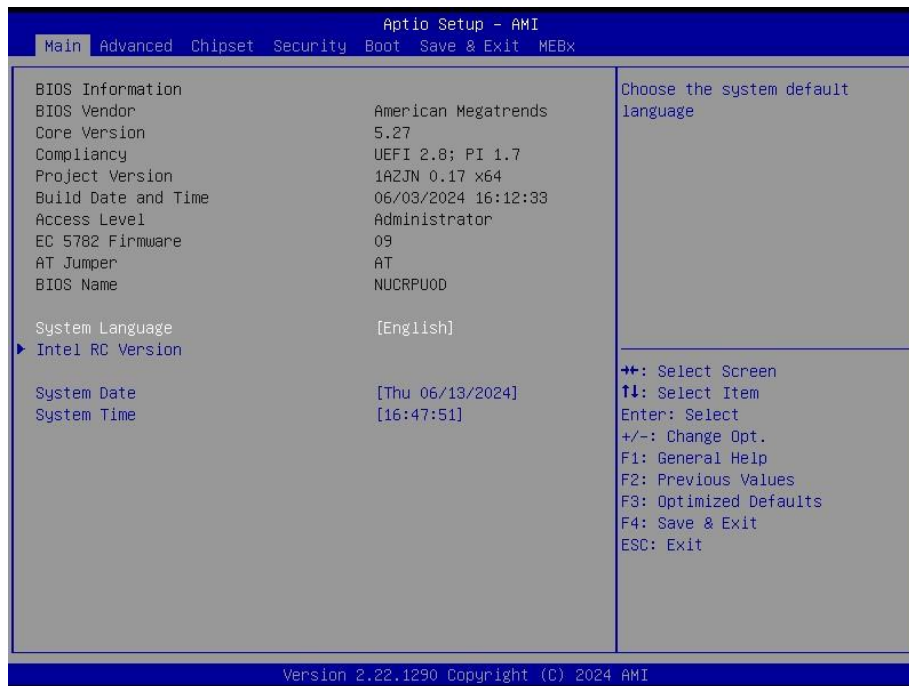

NUC-RPU

5.6.1.1 System Language

This option allows choosing the system default language.

5.6.1.2 System Date

Use the system date option to set the system date. Manually enter the month, day and year.

5.6.1.3 System Time

Use the system time option to set the system time. Manually enter the hours, minutes and seconds.



Note: The BIOS setup screens shown in this chapter are for reference purposes only, and may not exactly match what you see on your screen.

Visit the Avalue website (www.avalue.com) to download the latest product and BIOS information.

5.6.2 Advanced Menu

This section allows you to configure your CPU and other system devices for basic operation through the following sub-menus.

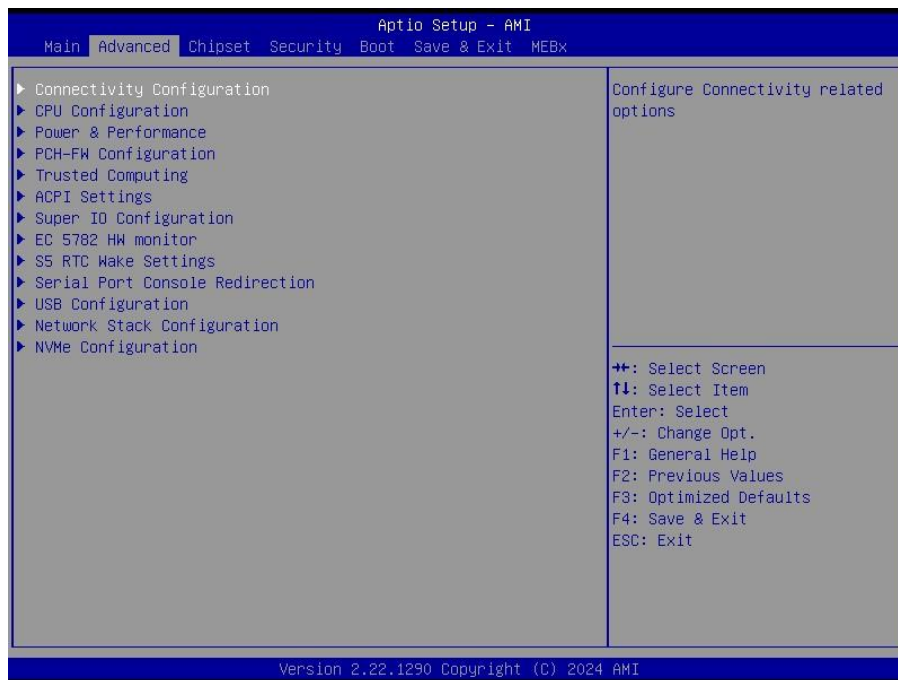

5.6.2.1 Connectivity Configuration



Item	Options	Description
CNVi Mode	Disable Integrated Auto Detection [Default]	This option configures Connectivity. [Auto Detection] means that if Discrete solution is discovered it will be enabled by default. Otherwise Integrated solution (CNVi) will be enabled; [Disable Integrated] disables Integrated Solution. NOTE: When CNVi is present, the GPIO pins that are used for radio.

5.6.2.2 CPU Configuration

Use the CPU configuration menu to view detailed CPU specification and configure the CPU.

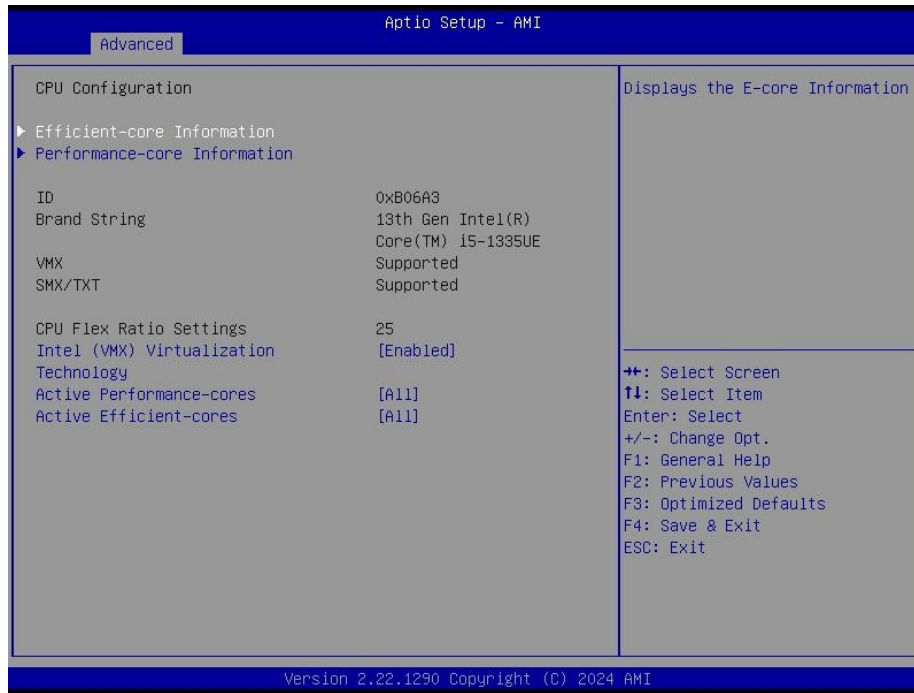

Item	Options	Description
Intel (VMX) Virtualization Technology	Disabled Enabled[Default]	When enabled, a VMM can utilize the additional hardware capabilities provided by Vanderpool Technology.
Active Performance-cores	All[Default] 7 6 5 4 3 2 1	Number of P-cores to enable in each processor package. Note: Number of Cores and E-cores are looked at together. When both are {0,0}, Pcode will enable all cores.
Active Efficient-cores	All[Default] 15 14 13 12 11 10 9 8	Number of E-cores to enable in each processor package. Note: Number of Cores and E-cores are looked at together. When both are {0,0}, Pcode will enable all cores.

5.6.2.2.1 Efficient-core Information

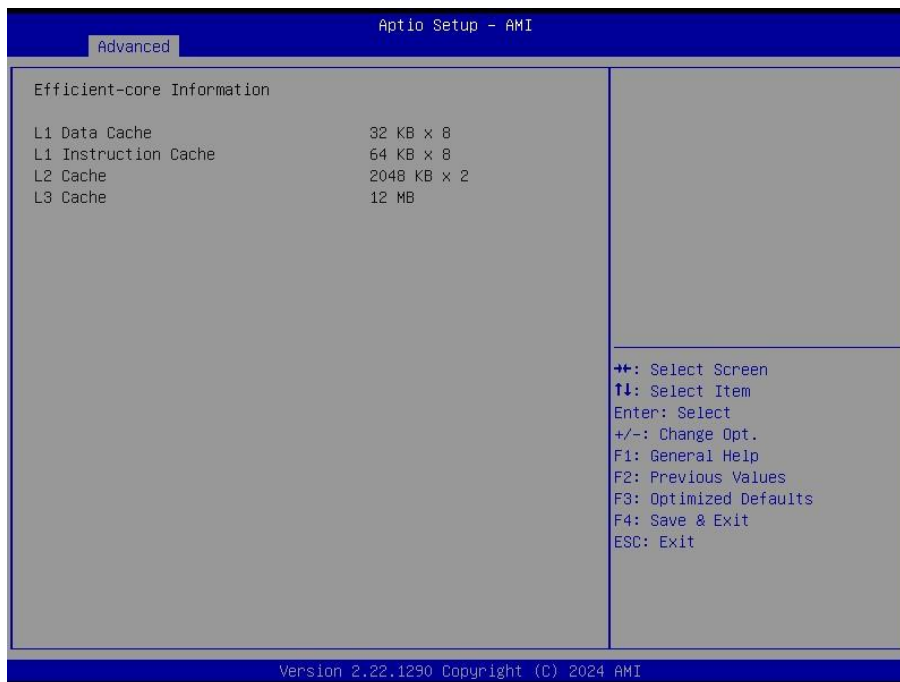

5.6.2.2.2 Performance-core Information

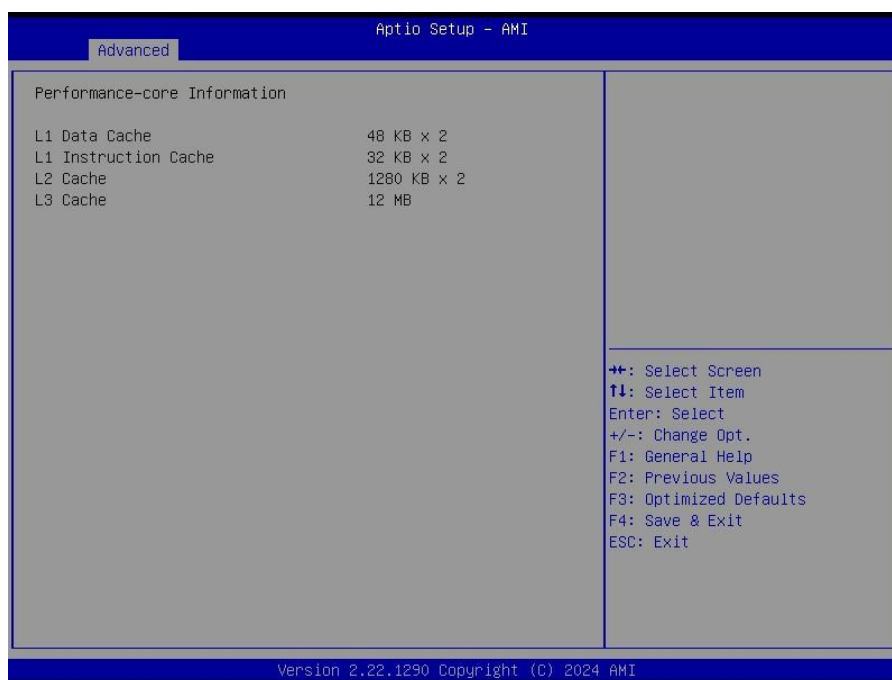

5.6.2.3 Power & Performance

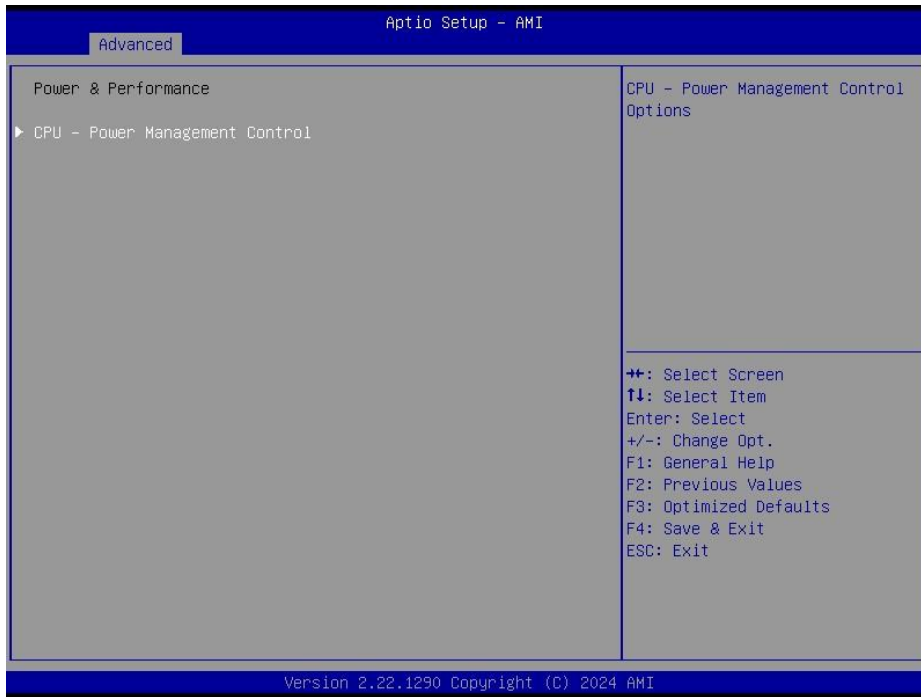

5.6.2.3.1 CPU – Power Management Control

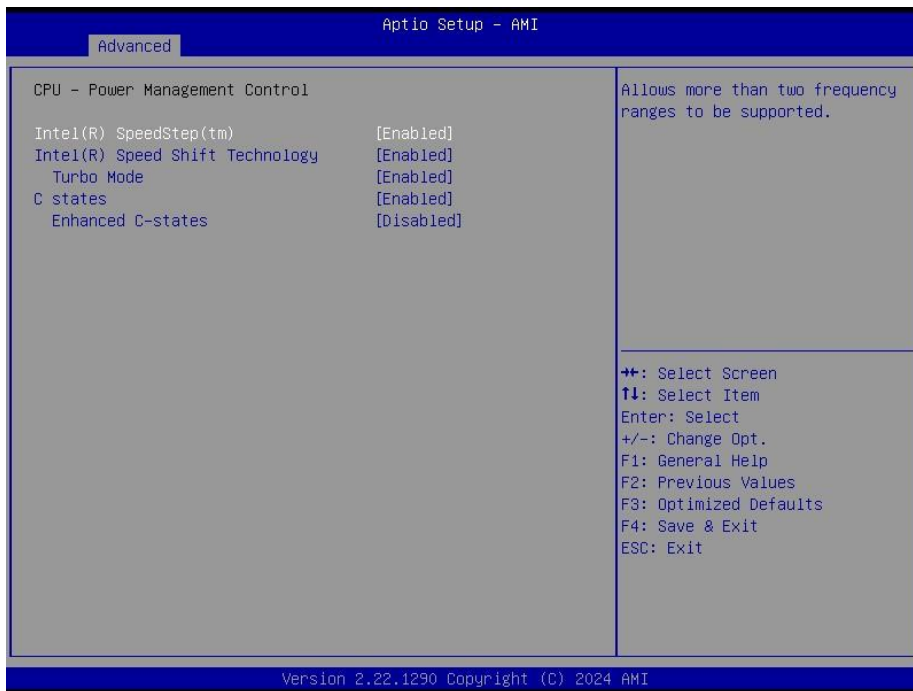

Item	Option	Description
Intel® SpeedStep™	Enabled[Default], Disabled	Allows more than two frequency ranges to be supported.
Intel® Speed Shift Technology	Enabled[Default], Disabled	Enable/Disable Intel® Speed Shift Technology support. Enabling will expose the CPPC v2 interface to allow for hardware controlled P-states.

Turbo Mode	Enabled[Default], Disabled	Enable/Disable processor Turbo Mode (requires Intel Speed Step or Intel Speed Shift to be available and enabled).
C States	Enabled[Default], Disabled	Enable/Disable CPU Power Management.
Enhanced C-States	Enabled, Disabled[Default]	Enable/Disable C1E. When enabled, CPU will switch to minimum speed when all cores enter C-State.

5.6.2.4 PCH-FW Configuration

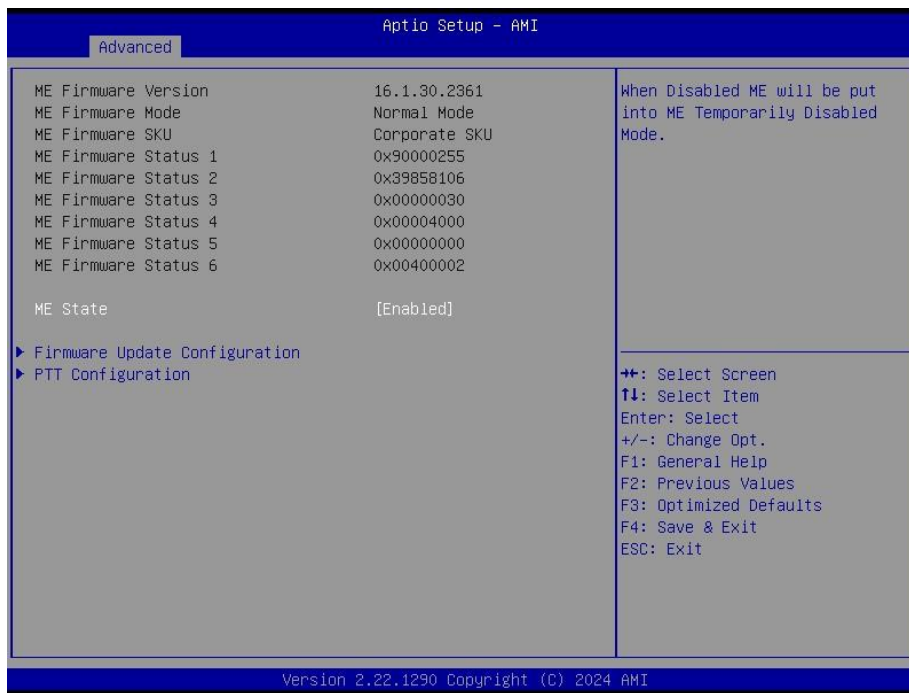

Item	Option	Description
ME State	Disabled Enabled[Default]	When Disabled ME will be put into ME Temporarily Disabled Mode.

NUC-RPU

5.6.2.4.1 Firmware Update Configuration

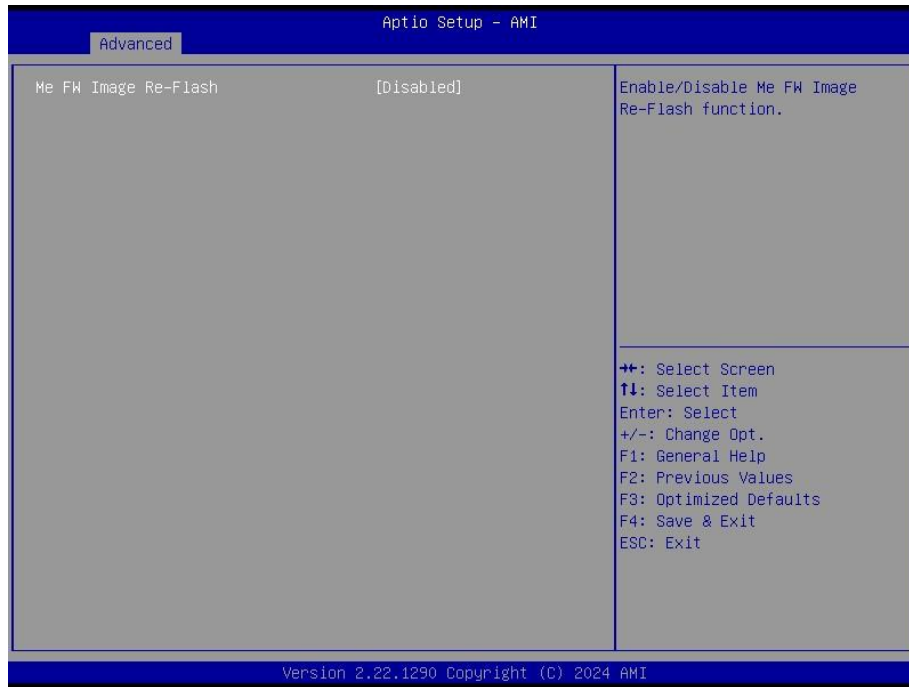

Item	Option	Description
ME FW Image Re-Flash	Disabled[Default], Enabled	Enable/Disable Me FW Image Re-Flash function.

5.6.2.4.2 PTT Configuration



Item	Option	Description
TPM Device Selection	dTPM[Default], PTT	Selects TPM device: PTT or dTPM. PTT-Enables PTT in SkuMgr dTPM1.2 – Disables PTT in SkuMgr Warning! PTT/dTPM will be disabled and all data saved on it will be lost.

5.6.2.5 Trusted Computing



Item	Options	Description
Security Device Support	Disable, Enable[Default]	Enables or Disables BIOS support for security device. O.S. will not show Security Device. TCG EFI protocol and INT1A interface will not be available.

5.6.2.6 APCI Settings

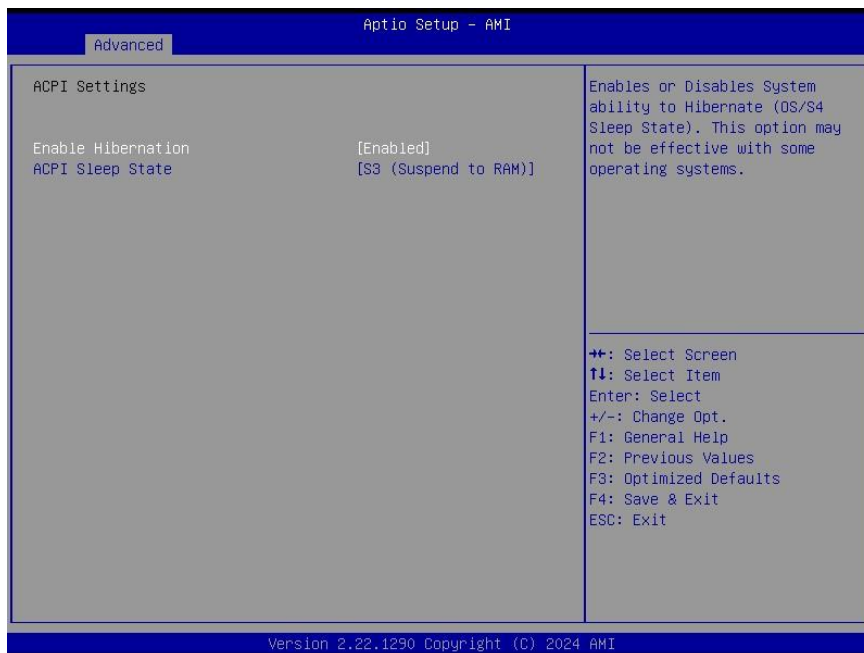

Item	Options	Description
Enable Hibernation	Disabled Enabled[Default],	Enables or Disables System ability to Hibernate (OS/S4 Sleep State). This option may not be effective with some OS.

NUC-RPU

ACPI Sleep State	Suspend Disabled, S3 (Suspend to RAM) [Default]	Select the highest ACPI sleep state the system will enter when the SUSPEND button is pressed.
-------------------------	---	---

5.6.2.7 Super IO Configuration

You can use this item to set up or change the Super IO configuration for serial ports. Please refer to 5.6.2.7.1 ~ 5.6.2.7.2 for more information.



Item	Description
Serial Port 1 Configuration	Set Parameters of Serial Port 1 (COMA).
Serial Port 2 Configuration	Set Parameters of Serial Port 2 (COMB).

5.6.2.7.1 Serial Port 1 Configuration

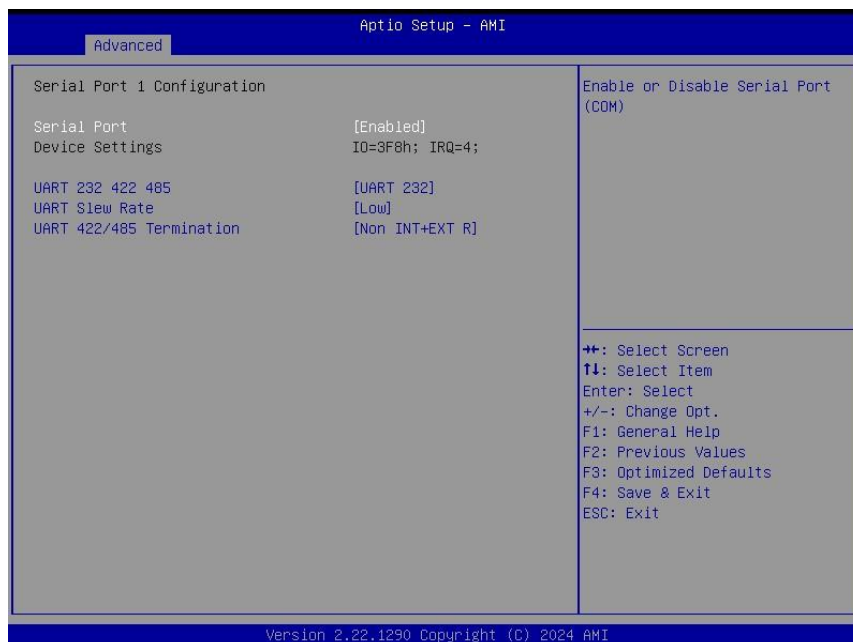

Item	Option	Description
Serial Port	Enabled[Default], Disabled	Enable or Disable Serial Port (COM).
UART 232 422 485	UART 232[Default] UART 422 UART 485	Change the Serial Port as RS232/422/485.
UART Slew Rate	Low[Default] High	Low: RS232/422/485 = 250Kbps High: RS422/485 = 20Mbps.
UART 422/485 Termination	Non INT+EXT R[Default] EXT R INT R INT+EXT R	Adjust the Serial Port with internal or external termination resistors.

5.6.2.7.2 Serial Port 2 Configuration



Item	Option	Description
Serial Port	Enabled[Default], Disabled	Enable or Disable Serial Port (COM).
UART 232 422 485	UART 232[Default] UART 422 UART 485	Change the Serial Port as RS232/422/485.
UART Slew Rate	Low[Default] High	Low: RS232/422/485 = 250Kbps High: RS422/485 = 20Mbps.
UART 422/485 Termination	Non INT+EXT R[Default] EXT R INT R INT+EXT R	Adjust the Serial Port with internal or external termination resistors.

NUC-RPU

5.6.2.8 EC 5782 HW Monitor



Item	Options	Description
Smart Fan Function	Enabled, Disabled[Default]	Enables or Disables Smart Fan.

5.6.2.9 S5 RTC Wake Settings



Item	Options	Description
Wake system from S5	Disabled[Default], Fixed Time Dynamic Time	Enable or disable System wake on alarm event. Select Fixed Time, system will wake on the hr::min::sec specified. Select Dynamic Time, System will wake on the current time + Increase minute(s).

5.6.2.10 Serial Port Console Redirection



Item	Options	Description
Console Redirection	Disabled[Default], Enabled	Console Redirection Enable or Disable.
Console Redirection EMS	Disabled[Default], Enabled	Console Redirection Enable or Disable.

5.6.2.10.1 Legacy Console Redirection Settings

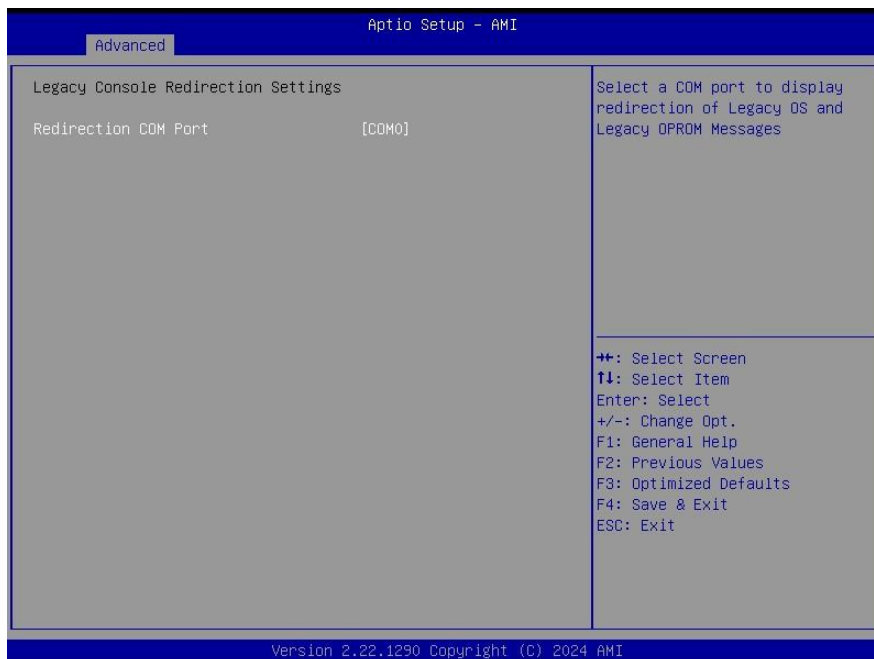

Item	Option	Description
Redirection COM Port	COM0[Default]	Select a COM port to display redirection of Legacy OS and Legacy OPROM Messages.

NUC-RPU

5.6.2.11 USB Configuration

The USB Configuration menu helps read USB information and configures USB settings.

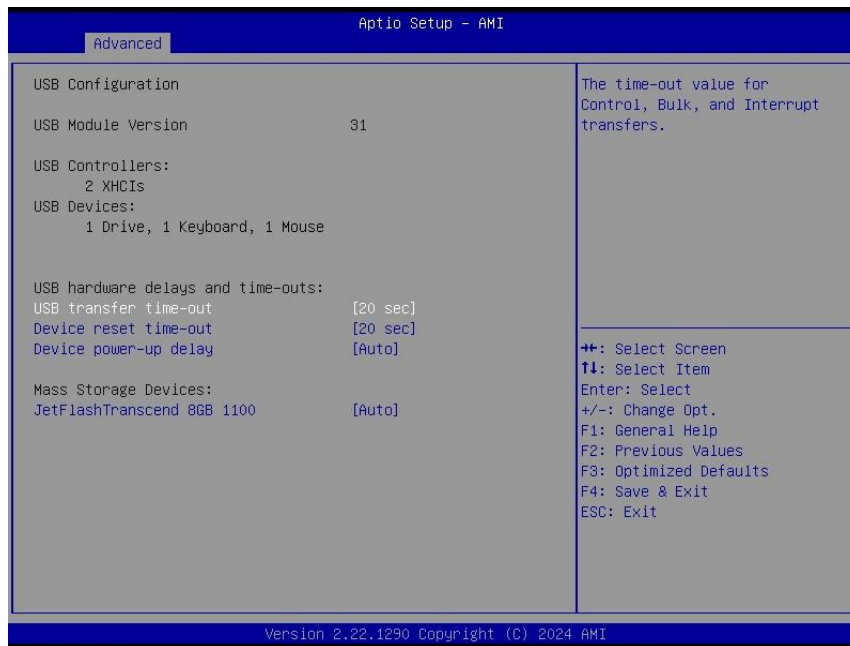

Item	Options	Description
USB transfer time-out	1 sec 5 sec 10 sec 20 sec [Default]	The time-out value for Control, Bulk, and Interrupt transfers.
Device reset time-out	10 sec 20 sec [Default] 30 sec 40 sec	USB mass storage device Start Unit command time-out.
Device power-up delay	Auto [Default] Manual	Maximum time the device will take before it properly reports itself to the Host Controller. 'Auto' uses default value: for a Root port it is 100ms, for a Hub port the delay is taken from Hub descriptor.
Mass Storage Devices	Auto [Default] Floppy Forced FDD Hard Disk CD-ROM	Mass storage device emulation type. 'AUTO' enumerates devices according to their media format. Optical drives are emulated as 'CDROM', drives with no media will be emulated according to a drive type.

5.6.2.12 Network Stack Configuration



Item	Options	Description
Network Stack	Enabled Disabled[Default]	Enable/Disable UEFI Network Stack.

5.6.2.13 NVMe Configuration

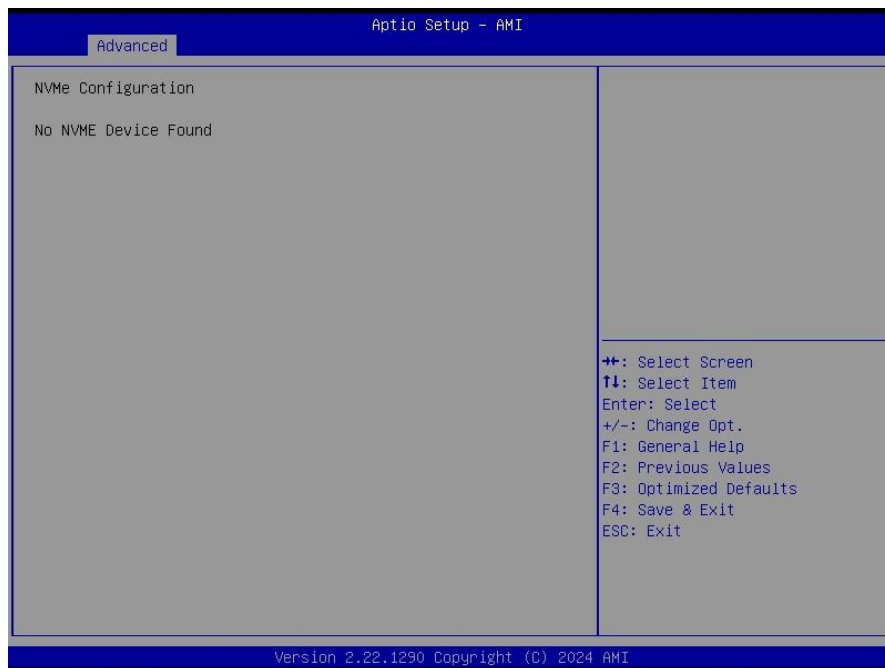

NUC-RPU

5.6.3 Chipset

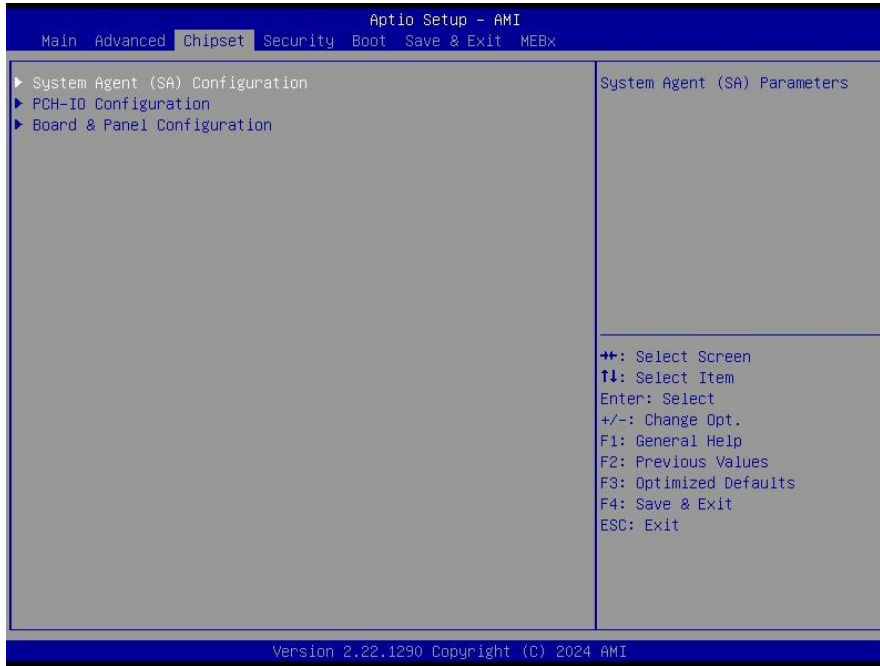

5.6.3.1 System Agent (SA) Configuration



Item	Option	Description
VT-d	Enabled Disabled[Default]	VT-d capability.

5.6.3.1.1 Memory Configuration

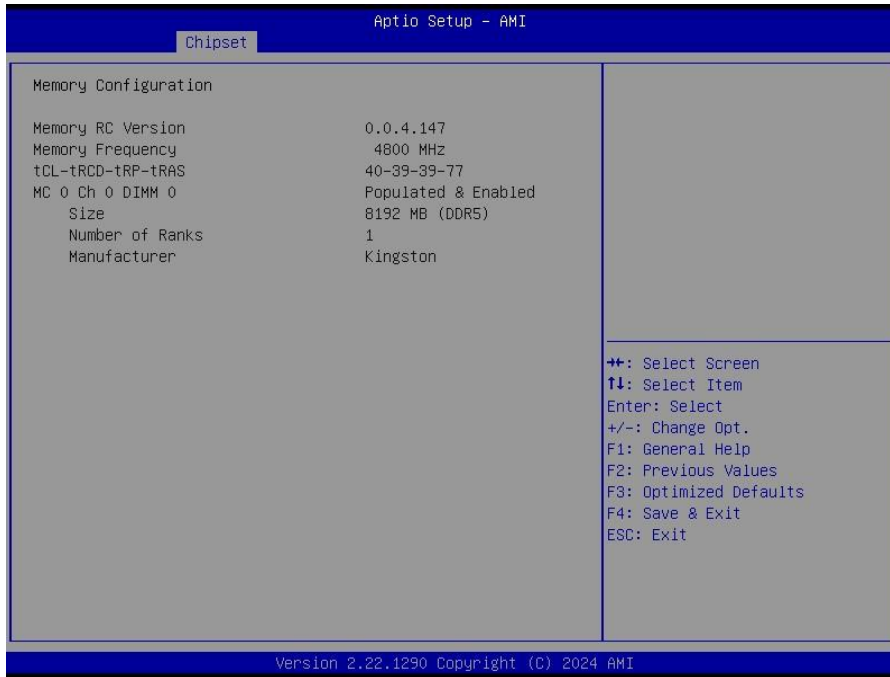

5.6.3.1.2 Graphics Configuration

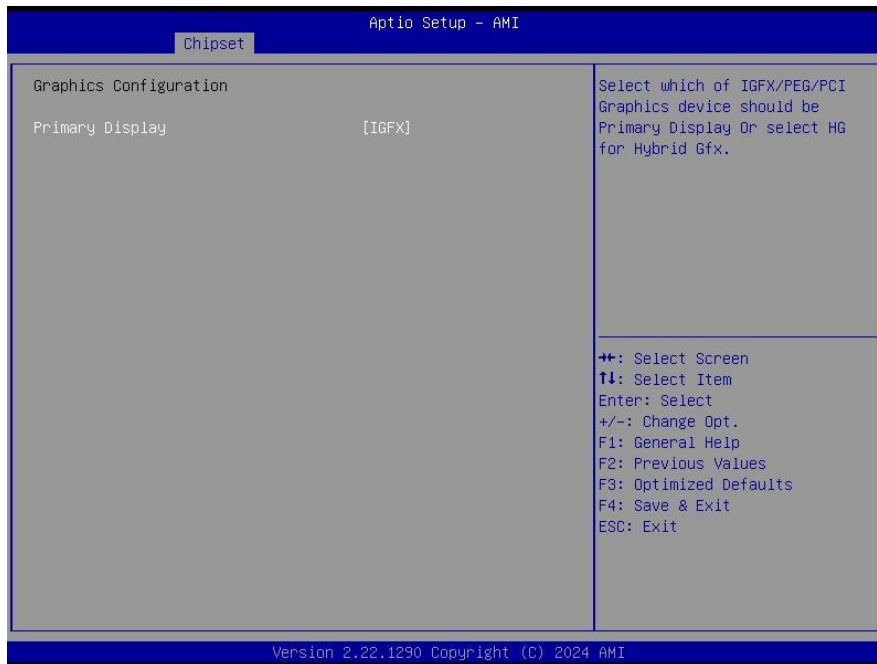

Item	Option	Description
Primary Display	Auto IGFX[Default]	Select IGFX Graphic device should be Primary Display.

NUC-RPU

5.6.3.2 PCH-IO Configuration



Item	Option	Description
PCH LAN Controller	Enabled[Default] Disabled	Enable/Disable onboard NIC.

5.6.3.2.1 PCI Express Configuration

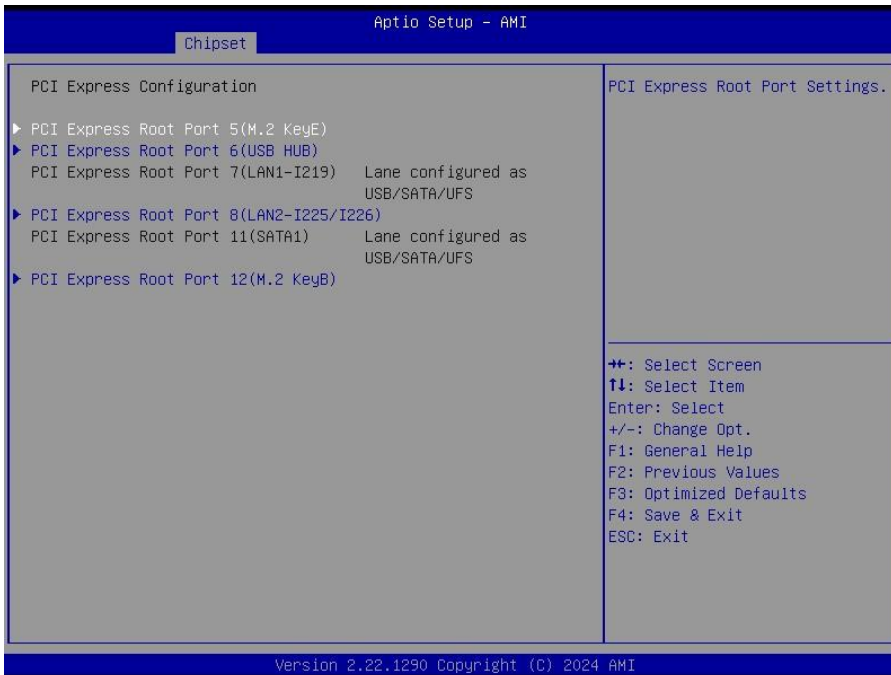

5.6.3.2.1.1 PCI Express Root Port 5(M.2 KeyE)

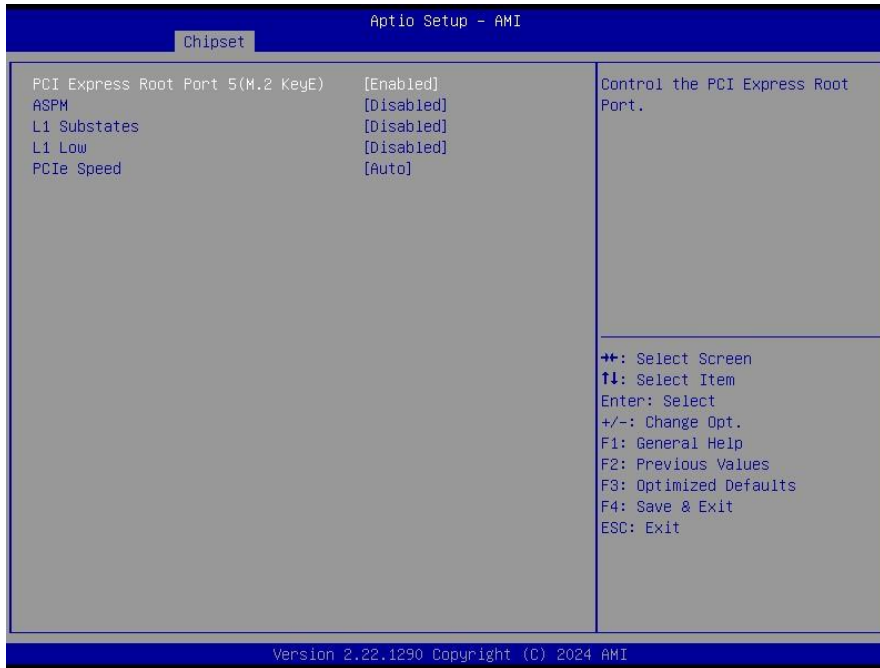

Item	Option	Description
PCI Express Root Port 5(M.2 KeyE)	Enabled[Default], Disabled	Control the PCI Express Root Port.
ASPM	Disabled[Default], L1 Auto	Set the ASPM Level: Force L0s – Force all links to L0s State AUTO – BIOS auto configure DISABLE – Disables ASPM.
L1 Substates	Disabled[Default] L1.1 L1.1 & L1.2	PCI Express L1 Substates settings.
L1 Low	Disabled[Default], Enabled	PCI Express L1 Substates Enable/Disable.
PCIe Speed	Auto[Default] Gen1 Gen2 Gen3	Configure PCIe Speed.

NUC-RPU

5.6.3.2.1.2 PCI Express Root Port 6(USB HUB)

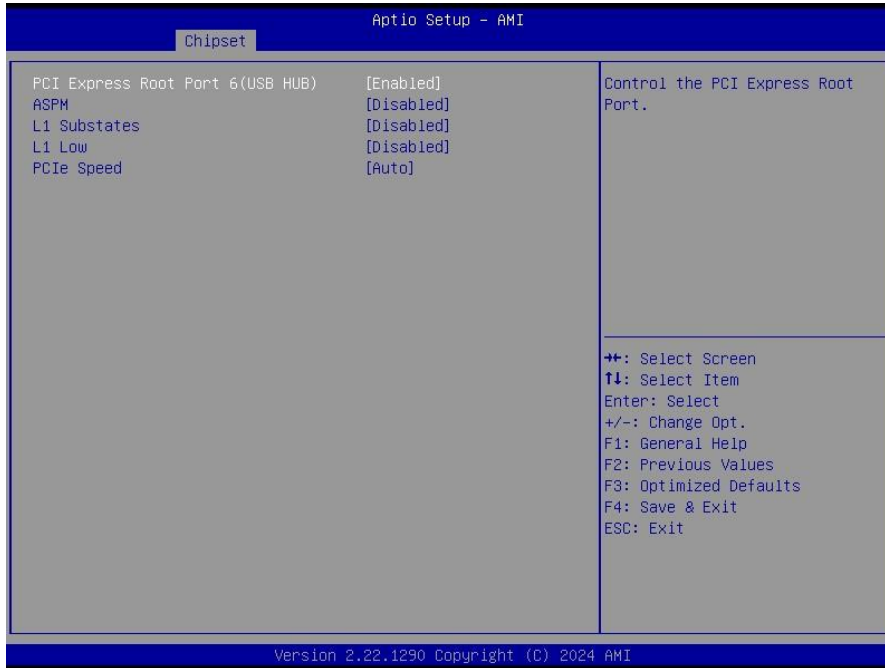

Item	Option	Description
PCI Express Root Port 6(USB HUB)	Enabled[Default], Disabled	Control the PCI Express Root Port.
ASPM	Disabled[Default], L1 Auto	Set the ASPM Level: Force L0s – Force all links to L0s State AUTO – BIOS auto configure DISABLE – Disables ASPM.
L1 Substates	Disabled[Default] L1.1 L1.1 & L1.2	PCI Express L1 Substates settings.
L1 Low	Disabled[Default], Enabled	PCI Express L1 Low Substates Enable/Disable.
PCIe Speed	Auto[Default] Gen1 Gen2 Gen3	Configure PCIe Speed.

5.6.3.2.1.3 PCI Express Root Port 8(LAN2-I225/I226)

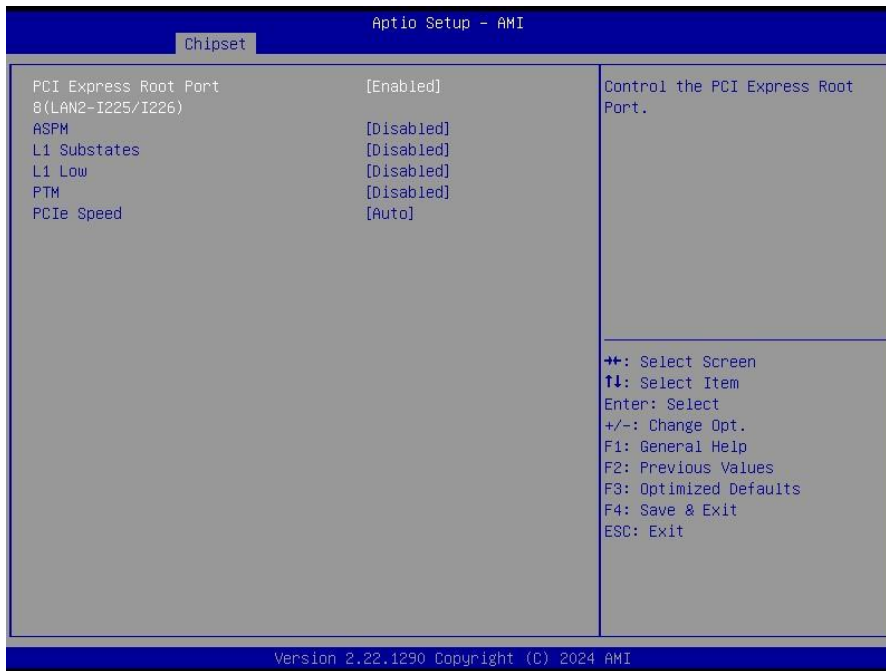

Item	Option	Description
PCI Express Root Port 8(LAN2-I225/I226)	Enabled[Default], Disabled	Control the PCI Express Root Port.
ASPM	Disabled[Default], L1 Auto	Set the ASPM Level: Force L0s – Force all links to L0s State AUTO – BIOS auto configure DISABLE – Disables ASPM.
L1 Substates	Disabled[Default] L1.1 L1.1 & L1.2	PCI Express L1 Substates settings.
L1 Low	Disabled[Default], Enabled	PCI Express L1 Low Substates Enable/Disable.
PTM	Disabled[Default], Enabled	Enable/Disable Precision Time Measurement.
PCIe Speed	Auto[Default] Gen1 Gen2 Gen3	Configure PCIe Speed.

NUC-RPU

5.6.3.2.1.4 PCI Express Root Port 12(M.2 KeyB)

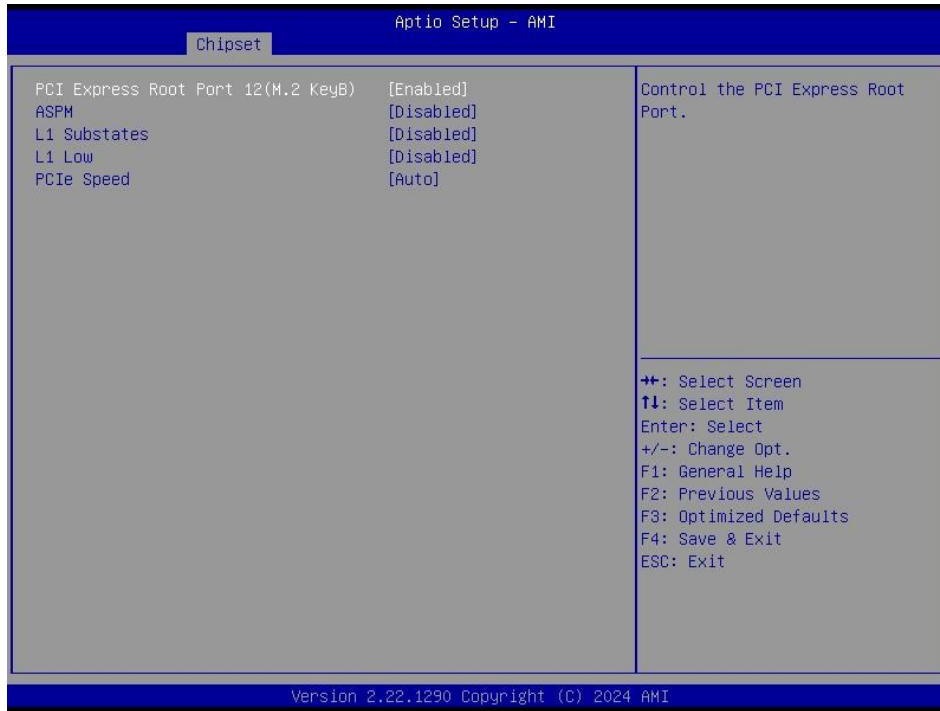

Item	Option	Description
PCI Express Root Port 12(M.2 KeyB)	Enabled[Default], Disabled	Control the PCI Express Root Port.
ASPM	Disabled[Default], L1 Auto	Set the ASPM Level: Force L0s – Force all links to L0s State AUTO – BIOS auto configure DISABLE – Disables ASPM.
L1 Substates	Disabled[Default] L1.1 L1.1 & L1.2	PCI Express L1 Substates settings.
L1 Low	Disabled[Default], Enabled	PCI Express L1 Low Substates Enable/Disable.
PCIe Speed	Auto[Default] Gen1 Gen2 Gen3	Configure PCIe Speed.

5.6.3.2.2 SATA Configuration

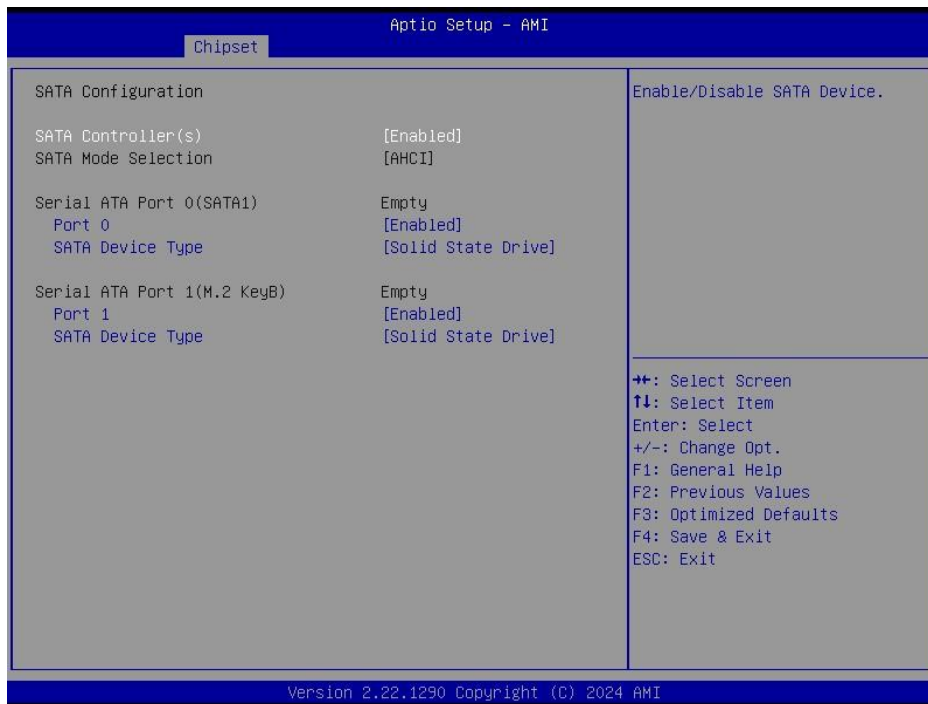

Item	Options	Description
SATA Controller(s)	Enabled[Default] Disabled,	Enable/Disable SATA Device.
Port 0	Enabled[Default] Disabled	Enable or Disable SATA Port.
SATA Device Type	Hard Disk Drive Solid State Drive[Default]	Identify the SATA port is connected to Solid State Drive or Hard Disk Drive.
Port 1	Enabled[Default] Disabled	Enable or Disable SATA Port.
SATA Device Type	Hard Disk Drive Solid State Drive[Default]	Identify the SATA port is connected to Solid State Drive or Hard Disk Drive.

5.6.3.2.3 HD Audio Configuration



Item	Option	Description
HD Audio	Disabled Enabled[Default]	Control Detection of the HD-Audio device. Disable = HDA will be unconditionally disabled Enabled = HDA will be unconditionally enabled.

5.6.3.3 Board & Panel Configuration

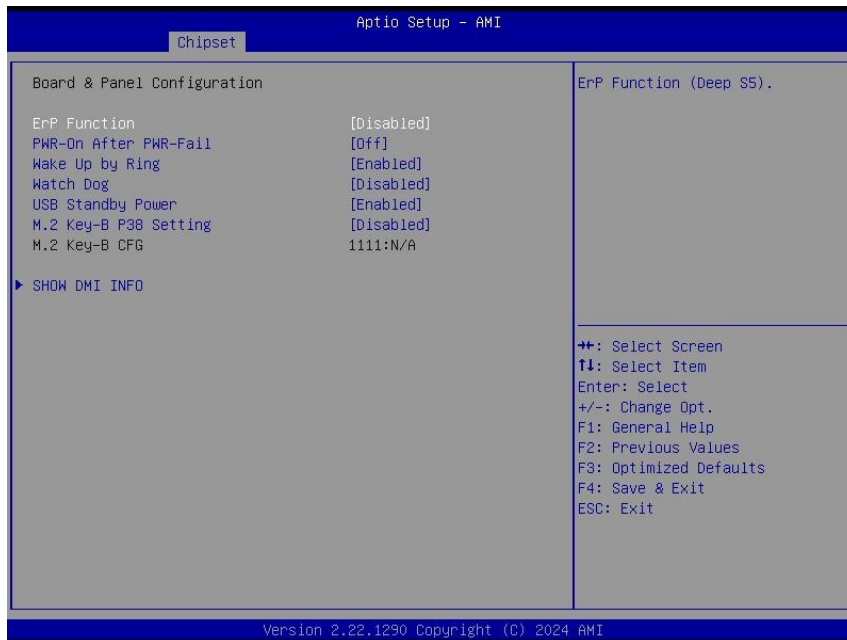

Item	Option	Description
ErP Function	Disabled[Default] Enabled	ErP Function (Deep S5).
PWR-On After PWR-Fail	Off[Default]	AC loss resume.

	On Last state	
Wake Up by Ring	Disabled Enabled[Default]	Wake Up by Ring from S3/S4/S5.
Watch Dog	Disabled[Default] 30 sec 40 sec 50 sec 1 min 2 min 10 min 30 min	Select WatchDog.
USB Standby Power	Disabled Enabled[Default]	Enable/Disabled USB Standby Power during S3/S4/S5.
M.2 Key-B P38 Setting	Disabled[Default] Enabled	Enabling will set M.2 KeyB Pin38(DEVSLP) as High.

5.6.3.3.1 SHOW DMI INFO

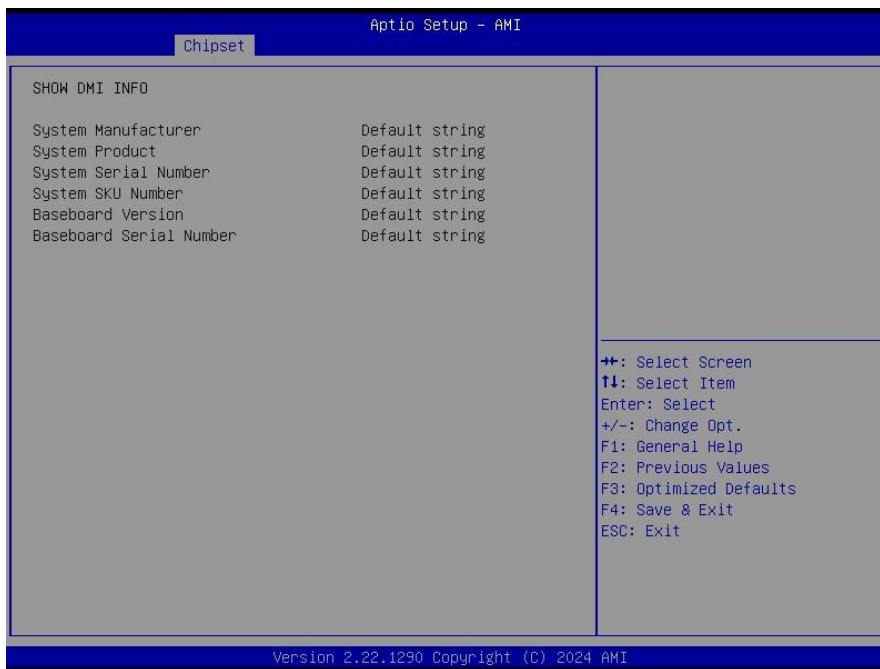

NUC-RPU

5.6.4 Security

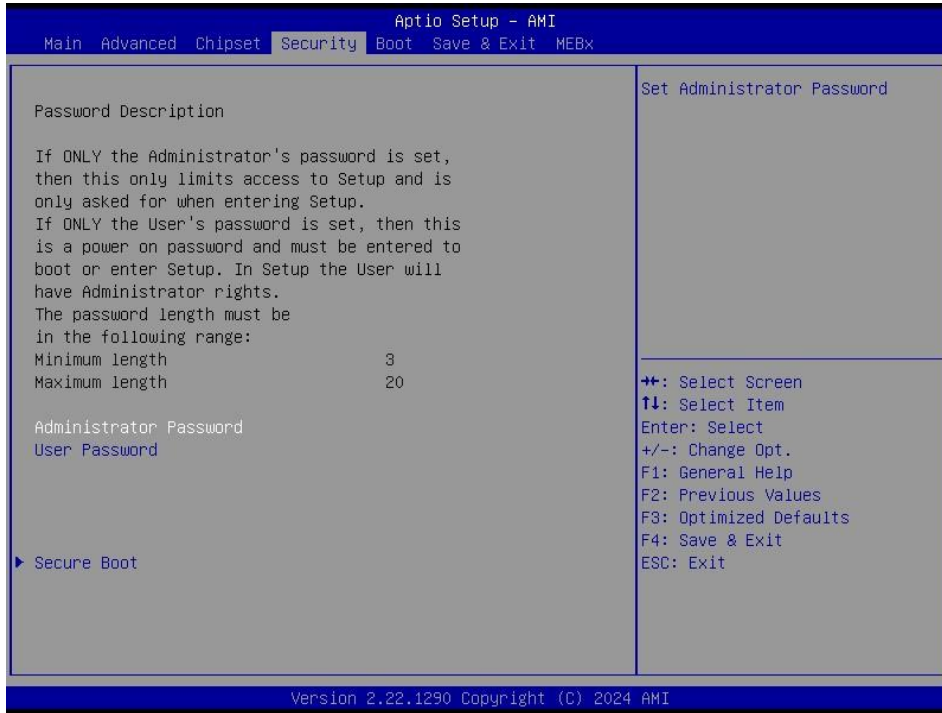

- **Administrator Password**

Set setup Administrator Password

- **User Password**

Set User Password

5.6.4.1 Secure Boot

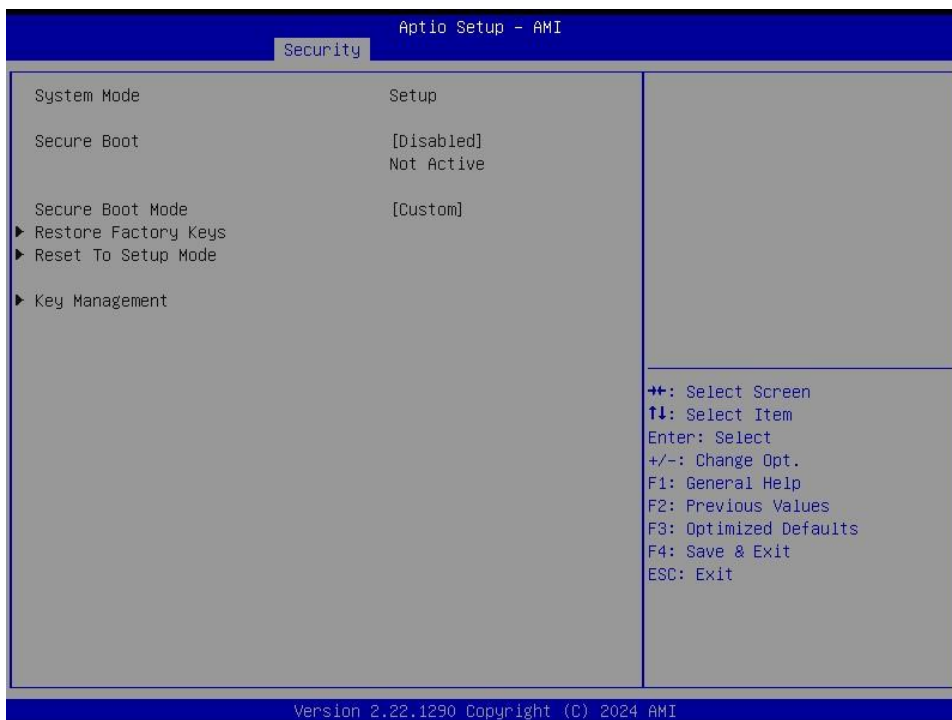

5.6.5 Boot

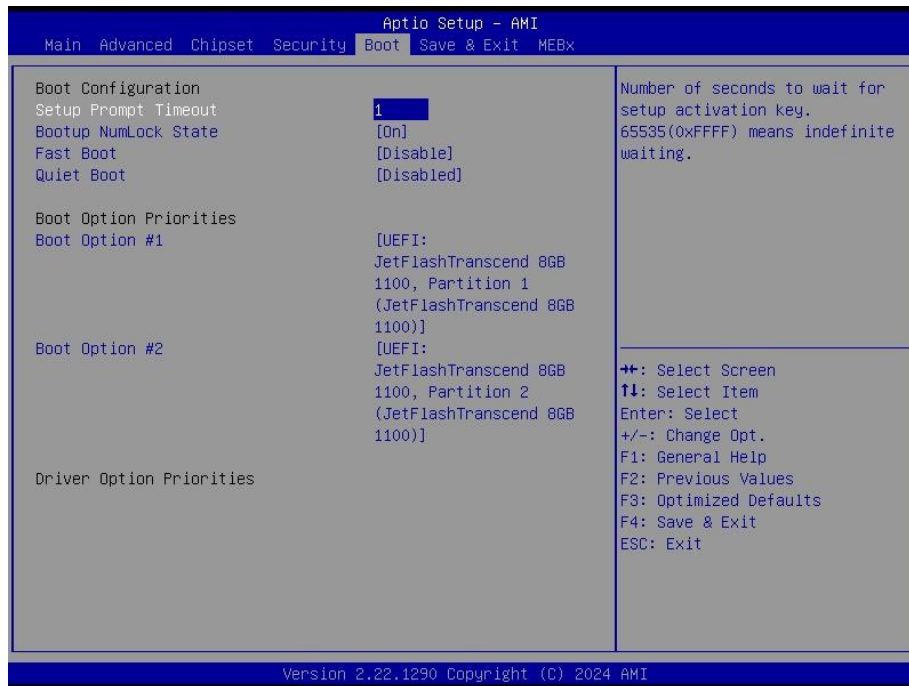

Item	Option	Description
Setup Prompt Timeout	1~ 65535	Number of seconds to wait for setup activation key. 65535(0xFFFF) means indefinite waiting.
Bootup NumLock State	On[Default] Off	Select the keyboard NumLock state
Fast Boot	Disabled[Default] Enabled	Enables or disables boot with initialization of a minimal set of devices required to launch active boot option. Has no effect for BBS boot optios.
Quiet Boot	Disabled[Default] Enabled	Enables or disables Quiet Boot option
Boot Option #1/2	Set the system boot order.	

5.6.6 Save and Exit

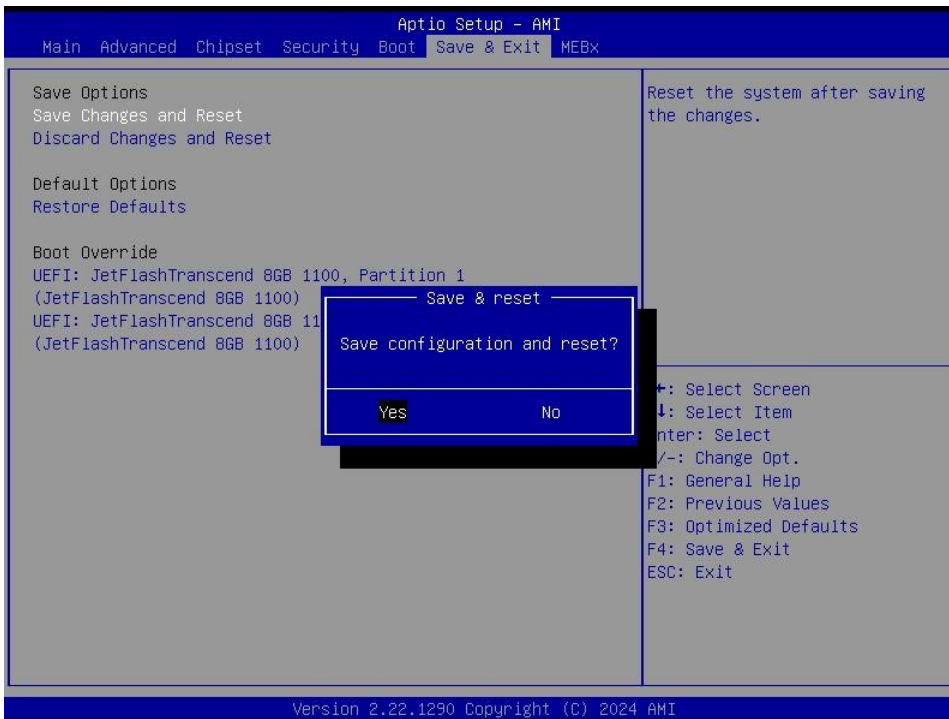
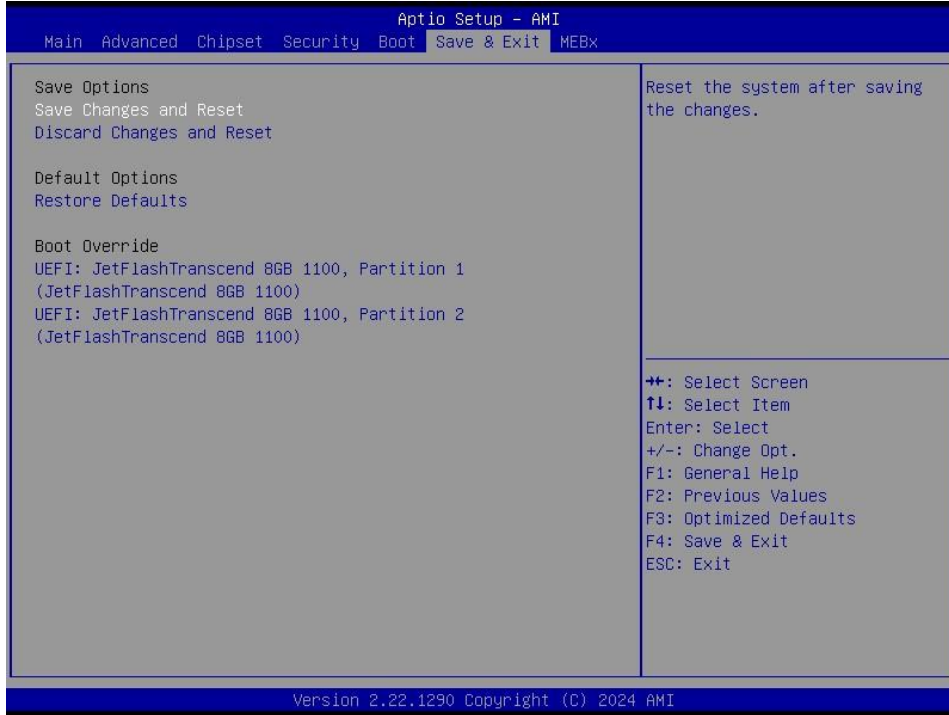

5.6.6.1 Save Changes and Reset

Reset the system after saving the changes.

5.6.6.2 Discard Changes and Reset

Any changes made to BIOS settings during this session of the BIOS setup program are discarded. The setup program then exits and reboots the controller.

5.6.6.3 Restore Defaults

This option restores all BIOS settings to the factory default. This option is useful if the controller exhibits unpredictable behavior due to an incorrect or inappropriate BIOS setting.

5.6.6.4 Launch EFI Shell from filesystem device

Attempts to Launch EFI Shell application (Shellx64.efi) from one of the available filesystem devices.

5.6.7 MEBx



- **Intel® ME Password**

MEBx Login

6. Maintenance & Troubleshooting

System Maintenance Introduction

If the components of the product fail they must be replaced.

Please contact the system reseller or vendor to purchase the replacement parts. Please follow the safety precautions outlined in the sections that follow

General Safety Precautions

Please ensure the following safety precautions are adhered to at all times.

1. Follow the electrostatic precautions outlined below whenever the device is opened.
2. Make sure the power is turned off and the power cord is disconnected whenever the product is being installed, moved or modified.
3. To prevent the risk of electric shock, make sure power cord is unplugged from wall socket. To fully disengage the power to the unit, please disconnect the power cord from the AC outlet. Refer servicing to qualified service personnel. The AC outlet shall be readily available and accessible.
4. Do not apply voltage levels that exceed the specified voltage range. Doing so may cause fire and/or an electrical shock. Use a power cord that matches the voltage of the power outlet, which has been approved and complies with the safety standard of your particular country.
5. Electric shocks can occur if the product chassis is opened when it is running. To avoid risk of electric shock, this device must only be connected to a supply mains with protective earth.
6. Do not drop or insert any objects into the ventilation openings of the product.
7. If considerable amounts of dust, water, or fluids enter the device, turn off the power supply immediately, unplug the power cord, and contact your dealer or the nearest service center.
8. This equipment is not suitable for use in locations where children are likely to be present.
9. DO NOT:
 - Drop the device against a hard surface.
 - Strike or exert excessive force onto the LCD panel.
 - Touch any of the LCD panels with a sharp object.
 - In a site where the ambient temperature exceeds the rated temperature.

Anti-Static Precautions

WARNING:

Failure to take ESD precautions during the installation of the product may result in permanent damage to the product and severe injury to the user.

Electrostatic discharge (ESD) can cause serious damage to electronic components, including the product. Dry climates are especially susceptible to ESD. It is therefore critical that whenever the product is opened and any of the electrical components are handled, the following anti-static precautions are strictly adhered to.

- Wear an anti-static wristband: Wearing a simple anti-static wristband can help to prevent ESD from damaging any electrical component.
- Self-grounding: Before handling any electrical component, touch any grounded conducting material. During the time the electrical component is handled, frequently touch any conducting materials that are connected to the ground.
- Use an anti-static pad: When configuring or working with an electrical component, place it on an anti-static pad. This reduces the possibility of ESD damage.
- Only handle the edges of the electrical component. When handling the electrical component, hold the electrical component by its edges. Please ensure the following safety precautions are adhered to at all times.

Maintenance and Cleaning

When maintaining or cleaning the product, please follow the guidelines below.

WARNING:

- For safety reasons, turn-off the power and unplug the panel PC before cleaning.
- If you dropped any material or liquid such as water onto the panel PC when cleaning, unplug the power cable immediately and contact your dealer or the nearest service center. Always make sure your hands are dry when unplugging the power cable.

Maintenance and Cleaning

Prior to cleaning any part or component of the product, please read the details below.

- Except for the LCD panel, never spray or squirt liquids directly onto any other components. To clean the LCD panel, gently wipe it with a piece of soft dry cloth or a slightly moistened cloth.
- The interior of the device does not require cleaning. Keep fluids away from the device interior.
- Be cautious of all small removable components when vacuuming the device.
- Never drop any objects or liquids through the openings of the device.
- Be cautious of any possible allergic reactions to solvents or chemicals used when cleaning the device.
- Avoid eating, drinking and smoking within vicinity of the device.

Cleaning Tools

Some components in the panel PC may only be cleaned using a product specifically designed for the purpose. In such case, the product will be explicitly mentioned in the cleaning tips. Below is a list of items to use when cleaning the panel PC.

- Cloth: Although paper towels or tissues can be used, a soft, clean piece of cloth is recommended when cleaning the device.
- Water or rubbing alcohol: A cloth moistened with water or rubbing alcohol can be used to clean the device.
- Using solvents: The use of solvents is not recommended when cleaning the device as they may damage the plastic parts.
- Vacuum cleaner: Using a vacuum specifically designed for computers is one of the best methods of cleaning the device. Dust and dirt can restrict the airflow in the device and cause its circuitry to corrode.
- Cotton swabs: Cotton swabs moistened with rubbing alcohol or water are excellent tools for wiping hard to reach areas.
- Foam swabs: Whenever possible, it is best to use lint free swabs such as foam swabs for cleaning.

7. Product Application

For detailed instructions on the operation of the Watchdog Timer and Digital I/O (DIO) features of this Panel PC, please refer to the comprehensive guide available in the "AvalueIOAPI" manual. Please reaching out to your respective distributors, Avalue technical support team, or Avalue customer service representatives for further information. Feel free to inquire about this supplementary resource to enhance your understanding of the Watchdog Timer and Digital I/O (DIO) Application for optimal utilization of your Panel PC.

8. Operating the Device

The Multi-Touch mode was pre-installed on the Panel PC and need tools for any customizations. Should you have specific requirements or encounter scenarios where a customized touch mode is necessary, we recommend reaching out to your local distributors, Avalue technical support team, or Avalue customer service representatives. These professionals can provide tailored guidance and assistance to address any unique needs related to Multi-Touch mode adjustments.